



12-24 VOLT
CONNECTING SYSTEMS
www.pro-car.de



For two decades now we have been developing, producing, and distributing high quality connecting systems in the 12-24 Volt range, providing customers with safe connections for on-board electrical systems in cars, trucks, mobile homes, motorbikes and boats.

Adding products, which have been especially developed for mobile applications through modern LED lighting technology as well as USB charging technology.

Customers' needs and demands, and our own experience and ideas keep our company up to date and dynamic, whereupon the quality of our products has the highest priority.



PRO CAR and their business partner are exhibiting at all important national and international trade fairs, which provides us with a wide range of detailed and specific customer information and feedback.

Our sales programme for OEMs, industry and trade:

Universal and safety universal plugs 1 A – 16 A for cigarette lighter and standard sockets.

Universal angular plugs with function control for mobile phone network and electrical accessories 7.5 A according to DIN EN ISO 4165.

Socket connectors, twin socket connectors, triple sockets and extension cables with contacts according to DIN ISO EN 4165.

Connectors with large socket connector (internal Ø 21 mm).

Custom-made assemblies.

Hand, reading and supplementary lights and innovative LED technology.

Electronic alarm devices.

Charging cable with USB connector and USB sockets.

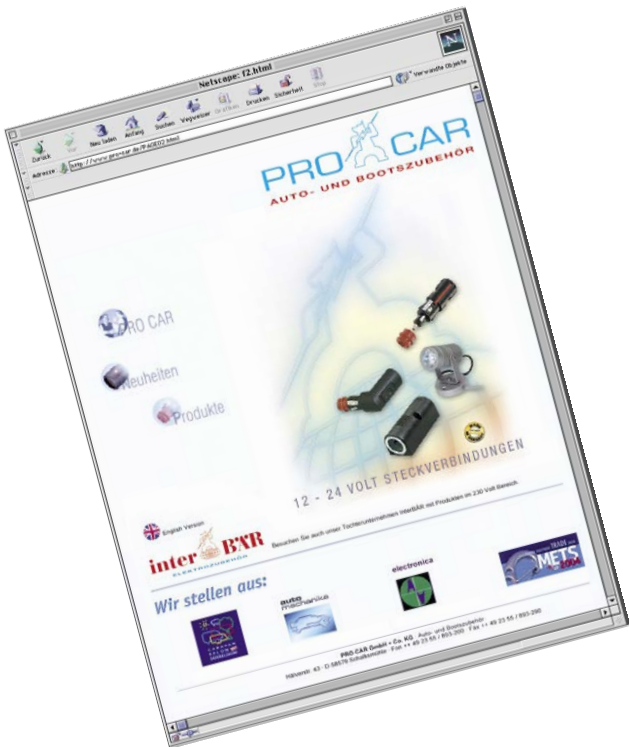

For further information visit our web-site:

www.pro-car.de

All items also available in single packaging (SP).



swing-out puller tool



optionally with LED

or without LED



with maze-like strain relief



or with screwed strain relief

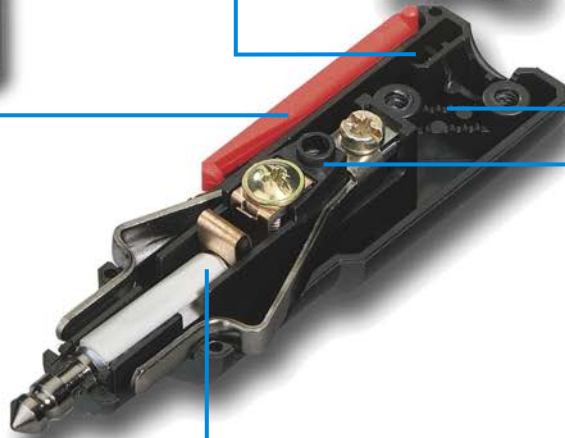

screw terminal for cables up to 2,5 mm²

available as safety universal plug fused up to 16 A

or as unfused universal plug



adaptor can be firmly positioned by a bayonet catch hence offering an excellent contact in the cigarette lighter socket





Universal Plug with screwed strain relief

8 and 16 A, 12-24 V, fitting for cigarette lighter and standard sockets, screw terminals for cables up to 2.5 mm², adaptor that can be firmly positioned by a bayonet catch, swing-out puller tool.

	BP	SP
	SU = 500	SU = 60
8 A	67711000	67721000
16 A TÜV certified	67711010	67721010



Universal Plug with maze-like strain relief

8 and 16 A, 12-24 V, fitting for cigarette lighter and standard sockets, screw terminals for cables up to 2.5 mm², adaptor that can be firmly positioned by a bayonet catch, swing-out puller tool.

	BP	SP
	SU = 500	SU = 60
8 A	67713000	67723000
16 A TÜV certified	67713010	67723010



Safety Universal Plug with screwed strain relief

With integrated, interchangeable fuse from 1-16 A, 12-24 V, fitting for cigarette lighter and standard sockets, screw terminals for cables up to 2.5 mm², adaptor that can be firmly positioned by a bayonet catch, swing-out puller tool.

fused	BP	SP
	SU = 500	SU = 60
1 A	67712001	67722001
2 A	67712002	67722002
5 A	67712005	67722005
8 A	67712000	67722000
16 A TÜV certified	67712010	67722010



Safety Universal Plug with maze-like strain relief

With integrated, interchangeable fuse from 1-16 A, 12-24 V, fitting for cigarette lighter and standard sockets, screw terminals for cables up to 2.5 mm², adaptor that can be firmly positioned by a bayonet catch, swing-out puller tool.

fused	BP	SP
	SU = 500	SU = 60
1 A	67714001	67724001
2 A	67714002	67724002
5 A	67714005	67724005
8 A	67714000	67724000
16 A TÜV certified	67714010	67724010

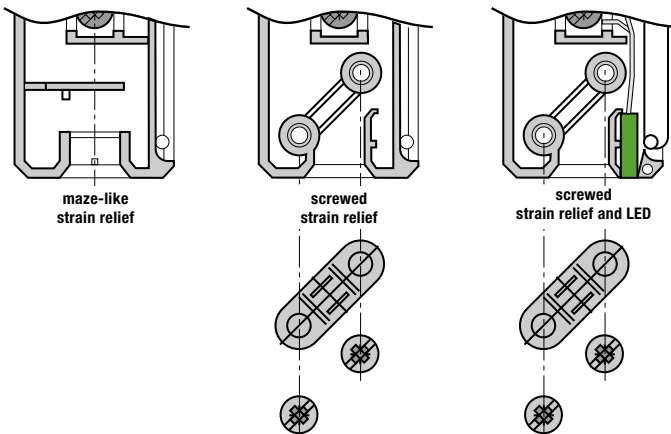



Universal Plug with screwed strain relief and LED

8 and 16 A, 12-24 V, fitting for cigarette lighter and standard sockets, screw terminals for cables up to 2.5 mm², adaptor that can be firmly positioned by a bayonet catch, swing-out puller tool.

	BP	SP
	SU = 500	SU = 60
8 A	67711100	67721100
16 A TÜV certified	67711110	67721110



Buckling Protective Sleeve

for universal plug and safety universal plug, standard internal Ø 4 mm.

BP
80106000

... great contact
and easy
to connect!



Safety Universal Plug with screwed strain relief and LED

With integrated, interchangeable fuse from 1-16 A, 12-24 V, fitting for cigarette lighter and standard sockets, screw terminals for cables up to 2.5 mm², adaptor that can be firmly positioned by a bayonet catch, swing-out puller tool.

	BP	SP
fused	SU = 500	SU = 60
1 A	67712101	67722101
2 A	67712102	67722102
5 A	67712105	67722105
8 A	67712100	67722100
16 A TÜV certified	67712110	67722110



Power Plug 20 A max. / 12-24 V

Assembled with cable 2 x 2.5 mm², length 1.2 m. Fitting for cigarette lighter and power sockets. For connecting coffee makers, kettles, heaters etc.

Special versions on request.

	BP	SP
	SU = 100	SU = 60
max. 20 A	67101284	67101285



Universal Angular Plug

With operational check by diode. 7.5 A / 12-24 V, adaptor that can be firmly positioned by a bayonet catch, screwed strain relief, cable cross-section max. 1.5 mm², Ø 8 mm, fitting for cigarette lighter and standard sockets according to DIN EN ISO 4165.

	BP	SP
	SU = 100	SU = 20
7,5 A	57730000	57730001



Bendable Universal Plug

Bendable up to 180°, with screw terminals, with or without strain relief, adaptor that can be firmly positioned by a bayonet catch, 12-24 V, fitting for cigarette lighter and standard sockets.

	BP	SP
	SU = 100	SU = 60
8 A with screwed strain relief	67741000	67741500
8 A without strain relief	67741100	–

Bendable Safety Universal Plug

Bendable up to 180°, with screw terminals, with or without strain relief, adaptor that can be firmly positioned by a bayonet catch, 12-24 V, fitting for cigarette lighter and standard sockets. With integrated, interchangeable fuse from 1-8 A / 12-24 V.

fused	BP	SP
	SU = 100	SU = 60
1 A with screwed strain relief	67742001	–
2 A with screwed strain relief	67742002	–
8 A with screwed strain relief	67742000	67742500
1 A without strain relief	67742101	–
2 A without strain relief	67742102	–
8 A without strain relief	67742100	–



Example of use

Offering sufficient space for your electronics.

dimensions for pcb:

- with screwed strain relief = 28.5 x 26.5 x 1.5 mm
- strain relief by prommet = 35.5 x 26.5 x 1.5 mm



Bendable Universal Plug with switch

8 A / 12-24 V, with single-pole circuit breaker 8 A, rocker switch imprinted with 0-I. The plug is bendable up to 180°, with screw terminals, adaptor that can be firmly positioned by a bayonet catch, fitting for cigarette lighter and standard sockets.

	BP	SP
	SU = 100	SU = 60
8 A	67746000	67746500

Bendable Safety Universal Plug with switch

8 A / 12-24 V, with single-pole circuit breaker 8 A, rocker switch imprinted with 0-I. The plug is bendable up to 180°, with screw terminals, adaptor that can be firmly positioned by a bayonet catch. With integrated, interchangeable fuse 8 A, fitting for cigarette lighter and standard sockets.

fused	BP	SP
	SU = 100	SU = 60
8 A	67747000	67747500



Bendable Universal Plug with switch

8 A / 12-24 V, with single-pole circuit breaker 8 A, rocker switch imprinted with 0-I, assembled with cable 2 x 0.75 mm², length 2.0 m. The plug is bendable up to 180°, with screw terminals, adaptor that can be firmly positioned by a bayonet catch, fitting for cigarette lighter and standard sockets.

	BP	SP
	SU = 100	SU = 60
8 A	67745000	67745500

Bendable Safety Universal Plug with switch

8 A / 12-24 V, with single-pole circuit breaker 8 A, rocker switch imprinted with 0-I, assembled with cable 2 x 0.75 mm², length 2.0 m. The plug is bendable up to 180°, with screw terminals, adaptor that can be firmly positioned by a bayonet catch. With integrated, interchangeable fuse 8 A, fitting for cigarette lighter and standard sockets.

fused	BP	SP
	SU = 100	SU = 60
8 A	67748000	67748500



Standard Plug 8 A

With soldering contacts and maze-like strain relief, for connecting any type of 8 A accessory, 12-24 V, fitting for all standard sockets according to DIN EN ISO 4165.

	BP	SP
	SU = 500	SU = 60
8 A	67751000	67751500



Standard Plug 15 A

With screw terminals, for connecting any type of 15 A accessory, 12-24 V, easy to assemble, optimal contact, fitting for all standard sockets according to DIN EN ISO 4165.

	BP	BP
	SU = 500	SU = 60
15 A	53005000	53005001

... fits well
great connections!



Standard Plug 12 A

With screw terminals and strain relief. For connecting any type of 12 A accessory, 12-24 V, fitting for all standard sockets according to DIN EN ISO 4165.

	BP	SP
	SU = 500	SU = 60
12 A	58078300	58078301



DIN-Socket-Adaptor 16 A

12-24 V. Adaptor for use of devices with cigarette lighter plug in standard sockets. Straight type, one side internal Ø 21mm fitting for cigarette lighter plugs, other side fitting for standard sockets according to DIN EN ISO 4165.

	BP	SP
	SU = 200	SU = 60
16 A	67872900	67882900



DIN-Standard Built-In Socket

With 6.3 mm flat terminals. Fastening by hexagon nut, fitting for standard and universal plug, 16 A / 12-24 V max., TÜV certified and monitored, with contacts according to DIN EN ISO 4165. Port for installation: 18 mm.

	BP	SP
	SU = 500	SU = 60
16 A	57607000	57607001



DIN-Standard Built-In Socket with Mounting Plate

With 6.3 mm flat terminals. Fastening by hexagon nut, fitting for standard and universal plug, 16 A / 12-24 V max., TÜV certified and monitored, with contacts according to DIN EN ISO 4165. Port for installation: 18 mm.

	BP	SP
	SU = 500	SU = 60
with protective cap	57607032	57607033
without protective cap	57607030	57607031



DIN-Standard Built-In Socket with Protective Cap

Dust and splash-proof version. With 6.3 mm flat terminals. Fastening by hexagon nut, fitting for standard and universal plug, 16 A / 12-24 V max., TÜV certified and monitored, with contacts according to DIN EN ISO 4165. Port for installation: 18 mm.

	BP	SP
	SU = 500	SU = 60
16 A	57607002	57607003



Motorcycle Socket with snap-on lid

12 V / 10 A, for connecting battery chargers, navigation systems, PDA's and other devices. Fitting for universal and safety universal plug, weather and splash-proof, assembled with approx. 50 cm cable, internal Ø 21 mm.

	BP	SP
	SU = 50	SU = 20
12 V / 10 A	57607050	57607550



DIN-Standard Built-In Socket, Metal, with Protective Cap

With 6.3 mm flat terminals, fitting for standard and universal plug, 16 A / 12-24 V max. Port for installation: 18 mm.

	BP	SP
	SU = 100	SU = 60
16 A	53114320	53114321



DIN Built-In Socket, waterproof

12-24 V, waterproof to IP 67, cables are waterproof encapsulated, with screw cap, 16 A, contacts according to DIN EN ISO 4165, ready-made 300 mm cable. Fastening by hexagon nut. Port for installation: 18.4 mm. Temperature resistant: -40°C to 105°C.

	BP	SP
	SU = 50	SU = 20
16 A	52005000	52005001



Surface Mounted Socket

With 6.3 mm flat terminals, fitting for standard and universal plug, 16 A / 12-24 V max., TÜV certified and monitored, with contacts according to DIN EN ISO 4165.

	BP	SP
	SU = 100	SU = 60
16 A	57608000	57608001



Surface Mounted Socket with Protective Cap

Dust-proof and splash-proof version. With 6.3 mm flat terminals, fitting for standard and universal plug, 16 A / 12-24 V max., TÜV certified and monitored, with contacts according to DIN EN ISO 4165.

	BP	SP
	SU = 100	SU = 60
16 A	57608002	57608003



Triple Built-In Socket

Three standard sockets, 12-24 V. Connection with 6.3 mm flat terminals. Overall load up of all three Sockets: 16 A, with contacts according to DIN EN ISO 4165.

	BP	SP
	SU = 100	SU = 60
16 A	57612002	57612003



Power Socket Connector

12-24 V, 20 A max. based on a cable cross section of 2.5 mm², 16 A based on a cable cross section of 1.5 mm², for constructing overhung connection. Internal Ø 21 mm, with 6.3 mm flat terminals, fitting for universal plug.

	BP	SP
	SU = 100	SU = 60
12-24 V / max. 20 A , with base plate	67604500	67614500



Surface Mounted Power Socket

12-24 V. Current-carrying capacity: 20 A based on a cable cross section of 2.5 mm², 16 A based on a cable cross section of 1.5 mm². Internal Ø 21 mm, with 6.3 mm flat terminals, fitting for universal plug.

	BP	SP
	SU = 100	SU = 60
12-24 V / max. 20 A	67604000	67614000



NEW
with **USB**

USB Surface Mounted Socket

12 V DC / 5 V DC 1000 mA, with intergrated power voltage converter, for charging and operating sat navs, mobile phones, smart phones, PDAs, digital cameras and devices that are suitable for charging by 5 Volt USB.

	BP	SP
	SU = 100	SU = 60
12 V	67313000	67313500



Triple Surface Mounted Power Socket

12-24 V, 20 A max. based on a cable cross section of 2.5 mm², 16 A based on a cable cross section of 1.5 mm². Internal Ø 21 mm. Mounting screws included

	BP	SP
	SU = 100	SU = 20
12-24 V	67601000	67611000



NEW
with **USB**

Triple Surface Mounted Socket with USB Socket

Two power sockets max. 20 A based on a cable cross section of 2.5 mm², 16 A based on a cable cross section of 1.5 mm² and one USB Socket 12 V DC / 5 V DC 1000 mA, for charging and operating sat navs, mobile phones, smart phones, PDAs, digital cameras and devices that are suitable for charging by 5 Volt USB.

	BP	SP
	SU = 100	SU = 20
12 V	67314000	67314500



Triple Power Socket

With universal plug 16 A, connection possible to all cigarette lighter sockets and DIN standard sockets, 12-24 V, 16 A max. with three sockets. Internal Ø 21 mm. Cable: 2 x 1.5 mm² flat cable. Length: 2.0 m

	BP	SP
	SU = 50	SU = 20
12-24 V / 16 A	67601500	67611500



NEW
with **USB**

Triple Power Socket with USB Socket

Two power sockets and one USB socket 12 V DC / 5 V DC 1000 mA, for charging and operating sat navs, mobile phones, smart phones, PDAs, digital cameras and devices that are suitable for charging by 5 Volt USB.

	BP	SP
	SU = 50	SU = 20
12 V / 16 A	67315000	67315500



Power Socket with clamp sleeve

Designed to operate electrical devices in cars, boats and caravans. Current-carrying capacity: 20 A based on a cable cross section of 2.5 mm², 16 A based on a cable cross section of 1.5 mm². Internal Ø 21mm, port for installation 27.8 mm. Fastening by clamp sleeve.

	BP	SP
illuminated	SU = 160	SU = 60
12 V, clamp sleeve clear	68040740	68140740
12 V, clamp sleeve red	68040750	68140750
12 V, clamp sleeve green	68040760	68140760
24 V, clamp sleeve clear	68040770	68140770
24 V, clamp sleeve red	68040780	68140780
24 V, clamp sleeve green	68040790	68140790

	BP	SP
without illumination	SU = 160	SU = 60
12-24 V, clamp sleeve green	68040860	68140860

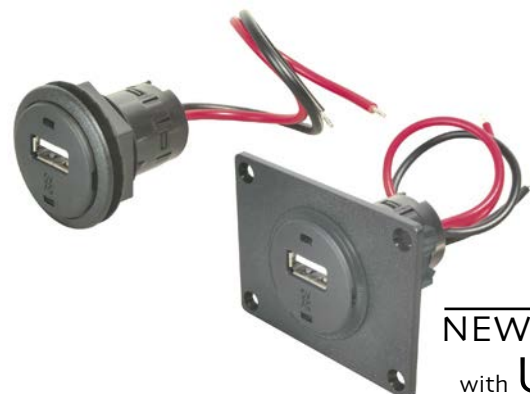

NEW
with **USB**

USB Built-In Socket with and without Mounting Plate

12 V DC / 5 V DC 1000 mA, with intergrated power voltage converter, for charging and operating sat navs, mobile phones, smart phones, PDAs, digital cameras and devices that are suitable for charging by 5 Volt USB. Fastening by plastic screw nut, installation dimensions Ø 27,8 mm

	BP	SP
	SU = 100	SU = 60
12 V, without mounting plate	67311000	67311500
12 V, with mounting plate	67312000	67312500



Power Socket with screw thread

Designed to operate electrical devices in cars, boats and caravans. Current-carrying capacity: 20 A based on a cable cross section of 2.5 mm², 16 A based on a cable cross section of 1.5 mm². Internal Ø 21 mm, port for installation 27.8 mm. Fastening by hexagon nut.

	BP	SP
	SU = 160	SU = 60
12-24 V, screw thread black	68040800	68140800
12-24 V, screw thread red	68040810	68140810
12-24 V, screw thread green	68040820	68140820



Power socket with Mounting Plate

12-24 V with clamp sleeve, without illumination, with mounting plate for front installation in e.g. thick-walled wood panels. Designed to operate electrical devices in cars, boats and mobile homes. Current-carrying capacity: 20 A based on a cable cross section of 2.5 mm², 16 A based on a cable cross section of 1.5 mm². Internal Ø 21 mm, port for installation 32 mm. Fastening by clamp sleeve snapped into the mounting plate: length: 60 mm, width: 45 mm, height: 2.2 mm. Mounting screws included.

	BP	SP
	SU = 160	SU = 60
12-24 V, clamp sleeve green, with mounting plate	68041000	68141000

... mature technology
for original equipment!



Cigarette Lighter with screw thread

12 and 24 V. With 6.3 mm flat terminals. Port for installation 27.8 mm. Fastening by hexagon nut. All versions also available for 24 V.

	BP	SP
	SU = 160	SU = 60
12 V, small knob, screw thread black	68031170	68131170
12 V, small knob, screw thread red	68031180	68131180
12 V, small knob, screw thread green	68031190	68131190
12 V, large knob, screw thread black	68031200	68131200
12 V, large knob, screw thread red	68031210	68131210
12 V, large knob, screw thread green	68031220	68131220



Cigarette Lighter with clamp sleeve, illuminated

12 and 24 V. With 6.3 mm flat terminals. Port for installation 27.8 mm. Fastening by clamp sleeve. All versions also available for 24 V.

	BP	SP
	SU = 160	SU = 60
12 V, small knob, clamp sleeve clear	68031050	68131050
12 V, small knob, clamp sleeve red	68031060	68131060
12 V, small knob, clamp sleeve green	68031070	68131070
12 V, large knob, clamp sleeve clear	68031080	68131080
12 V, large knob, clamp sleeve red	68031090	68131090
12 V, large knob, clamp sleeve green	68031100	68131100



Extension Cable

2 x 0.75 mm² helix cable. Length 0.6 m to 3.0 m.
With 8 A safety universal plug (integrated fuse) and socket connector (internal Ø 21 mm), 12-24 V.

	BP	SP
	SU = 100	SU = 20
8 A	67818100	67828100



Extension Cable

2 x 0.75 mm² flat cable. Length 4.0 m.
With 8 A safety universal plug (integrated fuse) and socket connector (internal Ø 21 mm), 12-24 V.

	BP	SP
	SU = 100	SU = 20
8 A	67814100	67824100



Extension Cable

2 x 0.75 mm² flat cable. Length 4.0 m. With 8 A safety universal plug (integrated fuse) and fracture-proof socket connector with contacts according to DIN EN ISO 4165, fitting for standard and universal plug.

	BP	SP
	SU = 100	SU = 20
8 A	67814000	67824000



Connector

8 A, (internal Ø 21 mm), with 1.0 m feeder and crocodile clips.

	BP	SP
	SU = 150	SU = 60
8 A	67874000	67884000



Helix Cable

2 x 0.75 mm² helix cable. Length 0.6 m to 3.0 m. With 8 A safety universal plug (integrated fuse) or universal plug. Standard version 8 A. Special versions on request.

	BP	SP
	SU = 100	SU = 20
with safety universal plug 8 A	67838000	67848000
with universal plug 8 A	67837000	67847000



Flat Cable

2 x 0.75 mm² flat cable. Length 4.0 m. With 8 A safety universal plug (integrated fuse) or universal plug. Standard version 8 A. Special versions on request.

	BP	SP
	VSU = 100	SU = 60
with safety universal plug 8 A	67834000	67844000
with universal plug 8 A	67833000	67843000



Flat Cable

2 x 0.75 mm² flat cable. Length 1.8 m. With socket connector (internal Ø 21 mm), 12-24 V, 8 A max.

	BP	SP
	SU = 150	SU = 20
8 A	67877000	67887000



Helix Cable

2 x 0.75 mm² helix cable. Length 0.6 m to 3.0 m. With socket connector (internal Ø 21 mm), 12-24 V, 8 A max

	BP	SP
	SU = 100	SU = 20
8 A	67878000	67888000



Adaptor

With standard plug and socket connector (internal Ø 21 mm), 12-24 V, 8 A max., 2 x 0.75 mm² flat cable, length 0.25 m.

	BP	SP
	SU = 200	SU = 60
8 A	67872000	67882000



Adaptor with Power Plug

With socket connector (internal Ø 12 mm) according to DIN EN ISO 4165, 12-24 V, 16 A max. Flat cable 2 x 1.5 mm², length 0.25 m.

	BP	SP
	SU = 200	SU = 60
16 A	67801000	67801500



Socket Connector

To install individual extensions for supplying power to electric accessories and lights, 16 A / 12-24 V max., with contacts according to DIN EN ISO 4165.

	BP	SP
	SU = 100	SU = 60
16 A	57620000	57620001

... manufacturing
and trade!



Twin Socket Connector

With two standard sockets to connect two electric accessories, flexible connection to the board system using the TÜV certified safety universal plug with interchangeable 16 A fuse, with contacts according to DIN EN ISO 4165.

	BP	SP
	SU = 50	SU = 20
16 A	67652000	67662000



PowerTwin Socket Connector

With universal plug 16 A, permits connection in all cigarette lighters sockets and DIN standard sockets, 12-24 V, max. 16 A with two socket-connectors, internal Ø 21mm. Sturdy design.

	BP	SP
	SU = 60	SU = 20
16 A	67654000	67664000



Twin Socket Connector

Connection is possible in all sockets for cigarette lighters, two large sockets (internal Ø 21 mm), 12-24 V, 2 x 8 A max. Integrated interchangeable 16 A fuse. 2 x 0.75 mm² flat cable, length 0.25 m.

	BP	SP
	SU = 100	SU = 20
16 A	67879000	67889000

... to connect
with the best contact!



Appliance Cable 2 A

Safety universal plug 2 A assembled with cable 2 x 0.4 mm², length 2 m and DC connector, angled.

	BP	SP
	SU = 200	SU = 60
DC connector 2.1 x 5.5 mm	67854900	67864900
DC connector 2.5 x 5.5 mm	67854910	67864910



Appliance Cable 8 A

Safety universal plug 8 A assembled with cable 2 x 0.75 mm², length 2 m and DC connector, straight.

	BP	SP
	SU = 200	SU = 60
DC connector 2.1 x 5.5 mm	67854930	67864930
DC connector 2.5 x 5.5 mm	67854920	67864920



e1 035605



Charging Cable with Micro USB Plug

12-24 V, output 5 V, 2000 mA. For charging and operating sat navs, mobile phones, smart phones, PDAs, digital cameras and devices that are suitable for charging by 5 V USB. With high-performance flyback converter and integrated protection against short-circuit, polarity reversal and overload. Fitting for cigarette lighter and standard socket by using an up to 180° bendable universal plug, cable length: appr. 1.80 m.

	BP	SP
	SU = 100	SU = 60
12-24 V	67303000	67303100



e1 035605



Charging Cable with Multi Plug

12-24 V, output 5 V, 2000 mA. Including four adapters for charging and using the most popular sat navs, PDAs, digital cameras and other electronic devices. With high-performance flyback converter and integrated protection against short-circuit, polarity reversal and overload. Fitting for cigarette lighter and standard socket by using an up to 180° bendable universal plug, cable length: appr. 1.50 m. Mini-USB Plug, 5.5 x 2.5 mm plug, 4.0 x 1.70 mm plug, 3.5 x 1.35 mm plug

	BP	SP
	SU = 100	SU = 60
12-24 V	67854850	67864850



e1 035605



Charging Cable with Mini USB Plug

12-24 V, output 5 V, 2000 mA. For charging and operating sat navs, mobile phones, smart phones, PDAs, digital cameras and devices that are suitable for charging by 5 V USB. With high-performance flyback converter and integrated protection against short-circuit, polarity reversal and overload. Fitting for cigarette lighter and standard socket by using an up to 180° bendable universal plug, cable length: appr. 1.80 m.

	BP	SP
	SU = 100	SU = 60
12-24 V	67854800	67864800



Digital Timer

Reliable on and off switching of programmed time sets - for electrical devices like cool-boxes, seat heatings, lamps etc. Board network 12 V DC ± 10%, breaking capacity max. 10 (5) A / 120 W resistive load, 28 storage locations (14 x on / 14 x off), daily and weekly programme.

	BP
	SU = 30
12 V / 8 A	50080000



NEW
with **USB**
CE

USB Extension Cable

With 2 A safety universal plug, input voltage 12 V battery power, output voltage USB 5 V DC 1000 mA. For charging and operating sat navs, mobile phones, smart phones and devices that are suitable for charging by 5 Volt USB.

	BP	SP
	SU = 100	SU = 60
12 V	68302050	68302150



NEW
with **USB**
CE

USB Charger Connector 5 V with protective cover

Input voltage 12 V battery power / output voltage USB 5 V DC 1000 mA. For charging and operating sat navs, mobile phones, smart phones and devices that are suitable for charging by 5 Volt USB.

	BP	SP
	SU = 100	SU = 60
12 V	68302010	68302110

rated voltage	12V
operation current	8A
cut-out voltage	11.5 ± 0.2V
cut-in voltage	12.6 ± 0.2V
natural current consumption = ON/OFF	20 / 5 mA



Battery Control

Protects the battery from excessive discharge caused by electrical appliances such as coolboxes, seat heatings, fans, etc. by automatic cut-out of the power supply. Renewed cut-in with the return of normal voltage conditions. Fitting for cigarette lighter and standard socket, with LED operational check and short circuit protection. 1.0 m feeder with connector (internal Ø 21 mm), bendable and therefore adjustable to various space conditions around the cigarette lighter.

	BP	SP
	SU = 100	SU = 10
12 V / 8 A	67301000	67301100



k.o.-Gasalarm 12-24 Volt

The protection against attacks with narcotic gases in mobile homes, cars and trucks.

Warning by loud signal, long before the gas effects.

- warns for narcotic gases
- with 1.8 m cable and bendable universal plug with switch for multiple use in 12 V sockets for cigarette lighter and standard built-in sockets
- audible and optical signal
- dimensions 130 x 75 x 40 mm
- wall mounting included

	SP
	SU = 50
12-24 V	52002005

k.o.-Gasalarm 12-24 Volt with relay 1 A

Option for connection with other devices e.g. additional alarm systems/sirenes/beacons. The protection against attacks with narcotic gases in mobile homes, cars and trucks.

	SP
	SU = 50
12-24 V	52002007



Dimmer 12 Volt DC and 12/24 Volt DC

Automatic switching between 12 V and 24 V operation. Regulates from 1.5 W up to 140 W 12 V DC and up to 280 W in 24 V DC systems. The dimmer is equipped with a unique output limiter, which maximizes the output to the nominal value for 12 and 24 V lamps and with a constant lighting feature. Short-circuit proof and protected against overloading, overvoltage, overtemperature and faulty connection. Dimensions: 60 x 60 x 35 mm, opening for installation: Ø 46 mm.

	Volt	Watt	SP
			SU = 50
white	12 V	70 W	50021000
brown	12 V	70 W	50021010
black	12 V	70 W	50021020
white	12 / 24 V	max. 140 / 280 W	50022000
brown	12 / 24 V	max. 140 / 280 W	50022010
black	12 / 24 V	max. 140 / 280 W	50022020

Further colours on request.

... electronics
for your safety!



k.o.-Gasalarm 230 Volt

The protection against attacks with narcotic gases in houses, flats, etc., warning by loud signal, long before the gas effects.

- warns for narcotic gases
- audible and optical signal
- dimensions 130 x 75 x 40 mm
- wall mounting included
- on/off-intermediate switch

	SP
	SU = 50
230 V	52002008



Reading Light „Pilot Light“

Ready for use without assembly. Light unit with slide switch, antiglare screen, integrated reflector, flexible arm moveable in all directions and safety universal plug. With integrated 8 A fuse to protect the board system, according to DIN EN ISO 4165. Connection to cigarette lighter and standard sockets without any problems.

	BP	SP
	SU = 100	SU = 60
12 V / 10 W	57406005	57406006



Supplementary Light „Backseat Light“

8 A, best as reading light in the passenger car's backseat, ideal for boats and caravans as well. Easy assembly by use of the enclosed assembly kit. Light unit with slide switch, antiglare screen and integrated reflector. Flexible light arm moveable in all directions.

	BP	SP
	SU = 50	SU = 20
12 V / 10 W	57405002	57405003



Superlux Halogen Hand and Reading Light

All-round light for cars, boats and caravans. Attachment of the multi-purpose ball jointed holder permanent by screw-on fastening.

12 V / 10 W halogen incandescent lamp and computer calculated reflector, optimal antiglare light distribution by prismatic lens, helix cable 0.6 to 3.0 m, safety universal plug, 8 A.

	BP	SP
	SU = 50	SU = 20
with holder 12 V / 10 W	57415002	57415001
without holder 12 V / 10 W	57415000	-



LED Nightlight

12 V / 0.6 W, 5 LED's integrated in bendable universal plug.

	BP	SP
	SU = 100	SU = 20
12 V / 0,6 W	57400600	57400601



Mini LED Spot, waterproof

12 V / 0.6 W, for lighting in wet areas or for permanent illumination and safety light. Dimensions: 14.5 x 30 mm.

	BP	SP
	SU = 100	SU = 20
12 V / 0,6 W	57400500	57400501

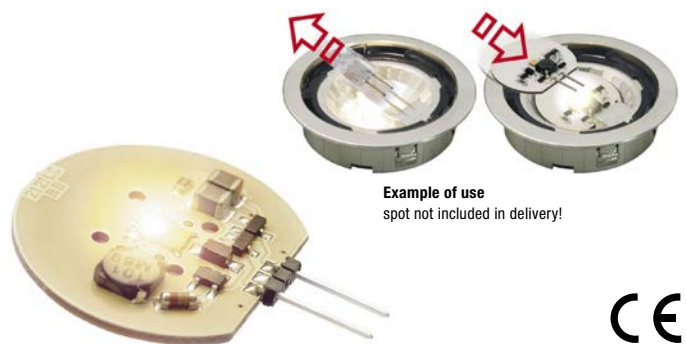

Example of use
spot not included in delivery!



Power LED illuminant

with G4 pin base on the side, 1.5 W. 12-24 V DC / 12 V AC, Ø 30 mm, Light-colour: warm-white 2,700 K. Keeps stable at voltage: 9-28 V DC / 9-20 V AC

	BP	SP
	SU = 100	SU = 60
12-24 V	57429000	57429050



Mini LED Spot

8-30 V battery current / 2.5 W. The ballast is integrated in the lamp base. Can be pivoted and swivelled, high luminance, making it ideal as a reading and spotlight in mobile homes, trucks, boats. When used at home a 230 V power supply unit can be connected. Light colour: warm-white 2,700 K, housing: aluminium-matt

	BP	SP
	SU = 20	SU = 20
without switch-key, 2.5 W	57421010	57421510
with switch-key, 2.5 W	57421111	57421611
Power LED Spot Maxi, with switch-key, 6 W	57421210	-

Surface Mounted / Built-In Power LED

8-30 V battery current / 3 W. All-purpose surface mounted / built-in LED light, with integrated ballast, pleasant warm white light colour, large radiation angle of 160°, extremely slim design, making it ideal for installation in/under cupboards and as an energy-saving light in mobile homes, trucks, boats. When used at home a 230 V power supply unit can be connected. Light colour: warm-white, housing: aluminium-matt

	BP	SP
	SU = 50	SU = 40
without switch-key	57423000	57423500
with switch-key	57423011	57423511

... future
LED technology



All dimensions in mm

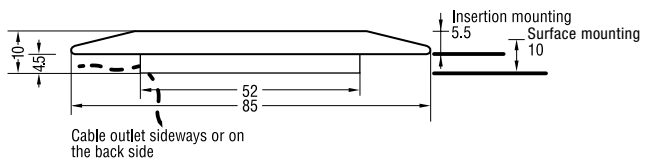

Diameter	85 mm
Height	10 mm
Operating voltage	8 – 30V
Current consumption	0.25A (bei 12V)
Power consumption	3W
LED Power	2.5W
Color temperature	2700 Kelvin
Angle of reflected beam	150°

Surface Mounted Power LED

8-30 V battery current / 3.6 W. Flat, all-purpose LED light with a large radiation angle of 160°, and an extremely slim design, making it ideal for installation in/under cupboards and as an energy-saving light in mobile homes, trucks, and boats. When used at home a 230 V power supply unit can be connected. Mounting via adhesive pads. Light colour: warm-white, 2,700 K, housing: aluminium-matt

	BP	SP
	SU = 20	SU = 20
round	57425000	57425500
square	57426000	57426500



Surface Mounted Power LED Maxi

11-30 V battery current / 6 W. All-purpose surface mounted Power LED light. Its large angle of reflected beam and its high capacity makes it perfect for illuminating rooms. For use in cars, boats, and mobile homes. When used at home a 230 V power supply unit can be connected. Measurements: diameter 120 mm, height: 10.5 mm. Light colour: warm-white, housing: aluminium-matt

	BP	SP
	VSU = 20	SU = 20
6 W	57424000	57424500

... saves up to
80% energy!

PRO CAR Terms of Delivery and Payment

1. General

With the „General Terms of Delivery concerning the Products and Services of the Electrical Industry“ taken as the basis, we are selling under the following terms and conditions unless expressly agreed to the contrary and made out in writing. Our terms of delivery shall prevail even in cases, where buyer expressly excludes the validity of supplier terms and conditions and an expressive objection has not been effected from our side. For any verbal arrangement or subsidiary agreement to be binding, they require to be confirmed by us in writing.

2. Prices

Prices are ex works and within the Federal Republic of Germany with Value Added Tax, as valid at the time. Extra costs for precious metals are detailed in our invoices and calculated on the average market price basis of the preceding month.

3. Delivery time

Delivery time will be given to our best estimate without binding us. With respect to the timing of any delivery buyer shall have no right to claim a delay in performance based on any statement from our side.

4. Terms of delivery

Orders valued above € 770,- free German border (DAF) ; below € 770,- ex works (EXW), including packaging. For orders below € 105,- a processing fee of € 13,- will be charged. For special type orders we reserve the right to over respectively underdeliver up to 10 percent of the quantities ordered respectively confirmed.

5. Terms of payment

Within 10 days from invoice date less 2% discount, within 30 days net. For any acceptance of bills bank charges will be born by the party issuing and require our special consent. We reserve the right to request collateral or payment in advance. In case of non-performance we are entitled to withhold all deliveries. Buyer, however, shall not be released from its obligation to accept the goods.

6. Reservation of ownership

Seller retains the title of ownership to the goods delivered by it and, which shall be disposed of only by way of doing proper business, until full payment from a contract has been received for amounts due inclusive of contingent bills that have been refinanced and acceptor's bills.

By integrating these goods into any other product the title thereto shall not pass on to buyer be it in part or in full; any further processing shall be at no cost to and exclusively in favour of seller. For the event of the title of ownership to the goods ceasing to exist for any reason whatsoever, seller and buyer herewith and hereby agree that the title of ownership to such goods having been processed shall pass on to seller, who herewith confirms to accept such transfer of title. Buyer remains depository thereof at no charge to seller. By integrating any goods with retained title of ownership seller automatically acquires co-ownership to the new products. The extend of co-ownership results from the ratio of amounts invoiced for the goods delivered by seller to the amounts invoiced for the new products.

Buyer herewith transfers all accounts outstanding from such sale of goods under reserved ownership to seller even inasmuch as such goods have been integrated into other products. In case the product, where sellers' goods have been integrated, include goods to which only seller retains the title of ownership, or which have been delivered under the so-called single party reservation of ownership, buyer transfers its entire purchase money claim to seller. In the other case, i.e. a combination of such assignment of claim to several suppliers, seller shall be entitled to only a proportion of such claims in the ratio of the amounts invoiced for its goods to the amounts invoiced for other goods integrated in the product.

Inasmuch as seller's total claims without any doubts are secured by such assignment in excess of 125%, the surplus of such outstanding accounts will then be released to buyer upon buyer's request and at seller's selection.

As long as buyer observes its obligation to make payments to seller it shall be entitled to collect outstanding accounts for its own credit until such right will be revoked. If buyer becomes insolvent, or makes any voluntary arrangement with its creditors or becomes subject to any administrative order, filing a petition to go into or declaring bankruptcy, faces any protest against a cheque or bill or has any property seized, then its right to sell or process any of the goods or to collect outstanding accounts will come to an end. Outstanding and assigned accounts received after such event immediately shall be deposited on a special bank account. A possible repurchase of any of the goods will be effected for security reasons only and shall constitute no withdrawal from the contract notwithstanding any subsequent payments in parts.

7. Warranty

Provided they are substantiated, queries of any kind will be considered within 15 days from the date of receiving the goods only. Any goods so queried at our discretion will be replaced at no cost to buyer, reworked, or taken back against credit for the contracted price. In case of any warranty failing or becoming impossible buyer will be entitled to withdraw from the contract. Claims are limited to the above warranty.

8. Tooling

All tooling supplied for the manufacturing of our products will pass into our ownership even in cases where the cost is shared in by the party ordering.

9. Modifications

We reserve the right to modify or improve any of our products.

10. Diverging and supplementary conditions

The acceptance of any order and delivery of goods by no means shall constitute an acceptance of buyer's terms and conditions. Such acceptance will require our expressive confirmation in writing. In addition to these terms of sale and delivery the „General Terms of Delivery concerning the Products and Services of the Electrical Industry“ shall be in force.

11. Law, place of performance and jurisdiction

These terms and conditions shall be governed by German law. Place of performance for delivery and payment shall be Schalksmühle. Place of jurisdiction shall be Lüdenscheid.

Version 7.10

This catalogue is copyrighted. Duplications or reprints (also in extracts) are only allowed with the written permit of the owner.

© July 2010 PRO CAR GmbH + Co. KG

Print: BDP Holtmann · Design: Ristock Grafik Design

20 Years
INNOVATION
EXPERTISE
PARTNER

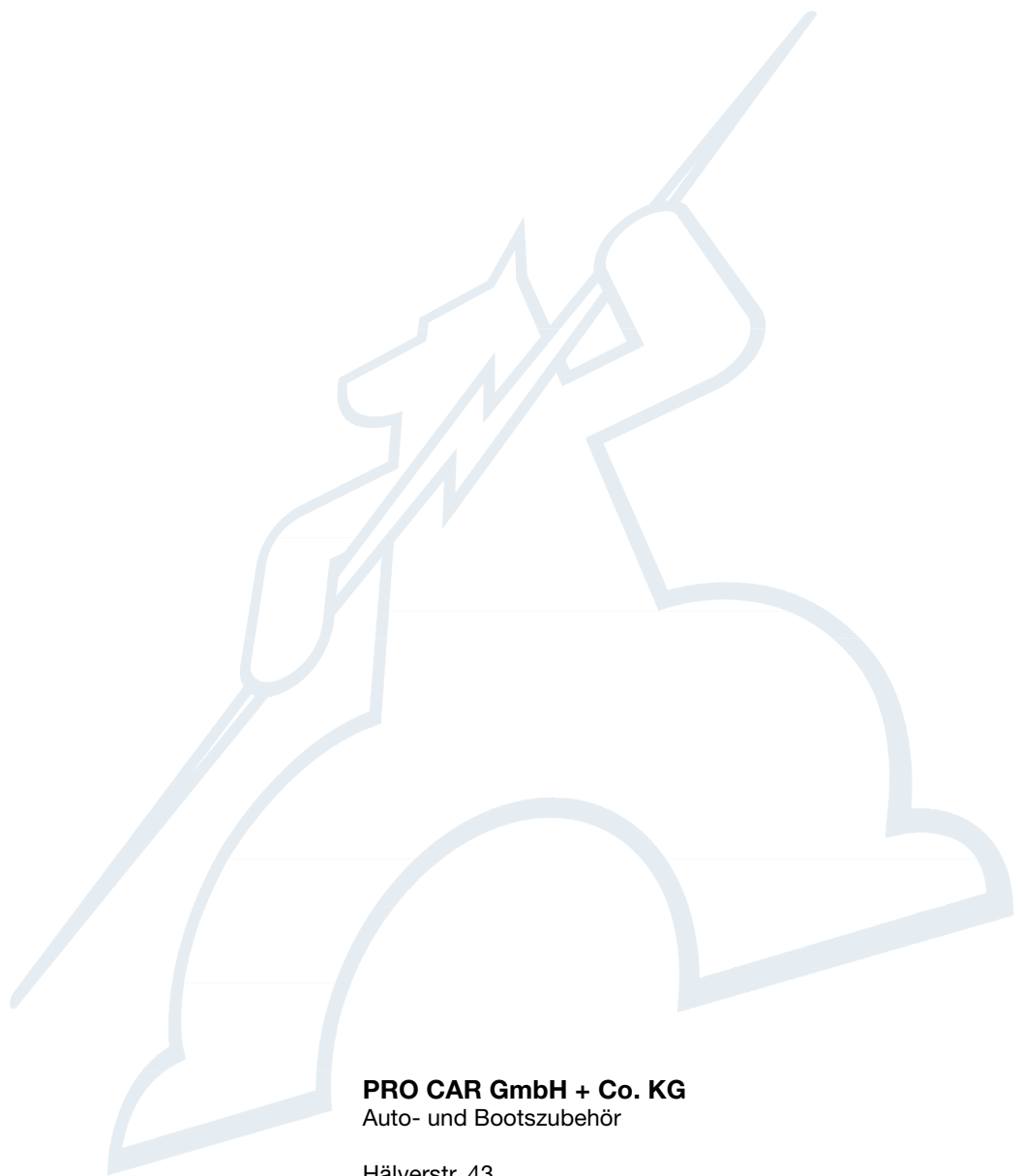

PRO CAR GmbH + Co. KG
Auto- und Bootszubehör

Hälverstr. 43
D-58579 Schalksmühle
Germany
Fon +49 (0) 23 55/893-200
Fax +49 (0) 23 55/893-290
www.pro-car.de
pro-car@pro-car.de