

# PRODUCT SPECIFICATIONS

For Customer: \_\_\_\_\_  : APPROVAL FOR SPECIFICATION

Customer Model No. \_\_\_\_\_  : APPROVAL FOR SAMPLE

Module No.: 4.3" TFT with CTP Date : 2019-11-16

### Table of Contents

No.	Item	Page
1	Cover Sheet(Table of Contents)	
2	Revision Record	
3	General Specifications	
4	Outline Drawing	
5	Absolute Maximum Ratings	
6	Electrical Specifications and Instruction Code	
7	Optical Characteristics	
8	Reliability Test Items and Criteria	
9	Packing Reliability	

### For Customer's Acceptance:

Approved By	Comment

PREPARED	CHECKED	VERIFIED BY QA DEPT	VERIFIED BY R&D DEPT

**2. Revision Record**

Date	Rev.No.	Page	Revision Items	Prepared

### 3. General Specifications

4.3" TFT with Capacitive Touch Screen is composed of a TFT- LCD panel, driver IC, FPC, TP, a back light unit. The 4.3" display area contains 480 x 270pixels and can display up to 16.7M colors. This product accords with RoHS environmental criterion.

Item	Contents	Unit	Note
LCD Type	TFT	-	
Display color	16.7M		
Grey scale inversion	6	O'Clock	
Viewing Direction	12	O'Clock	
Operating temperature	-20~+70	°C	
Storage temperature	-30~+80	°C	
Module size	Refer to outline drawing	mm	
Active Area(W×H)	95.04X53.86	mm	
Number of Dots	480×272	dots	
Controller	ILI6480	-	
Touch controller	FT5216	-	
Power Supply Voltage	3.3	V	
Outline Dimensions	Refer to outline drawing	-	
Backlight	5X2-LEDs (white)	pcs	
Weight	---	g	
Interface	RGB-24BIT	-	

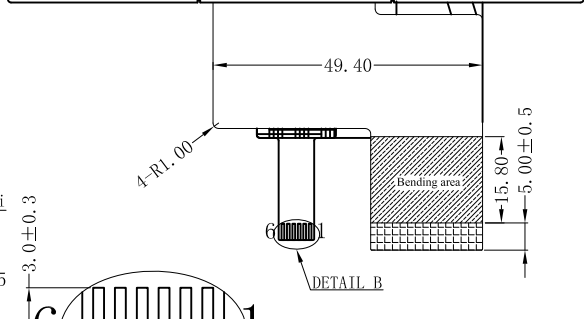
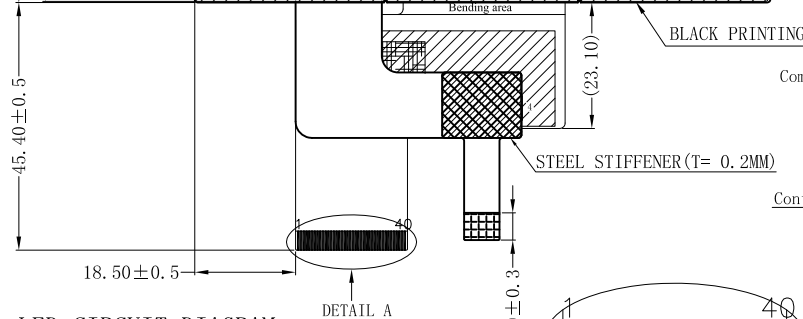
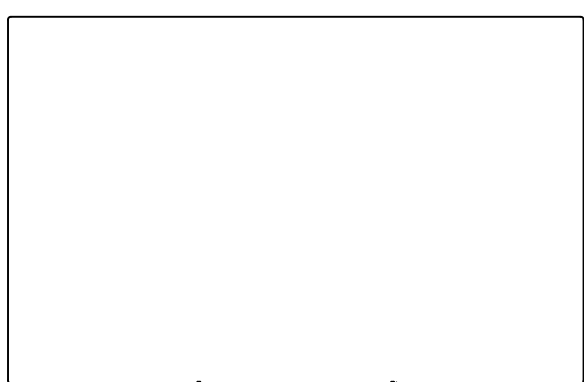
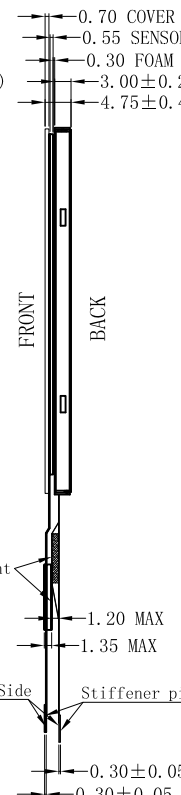
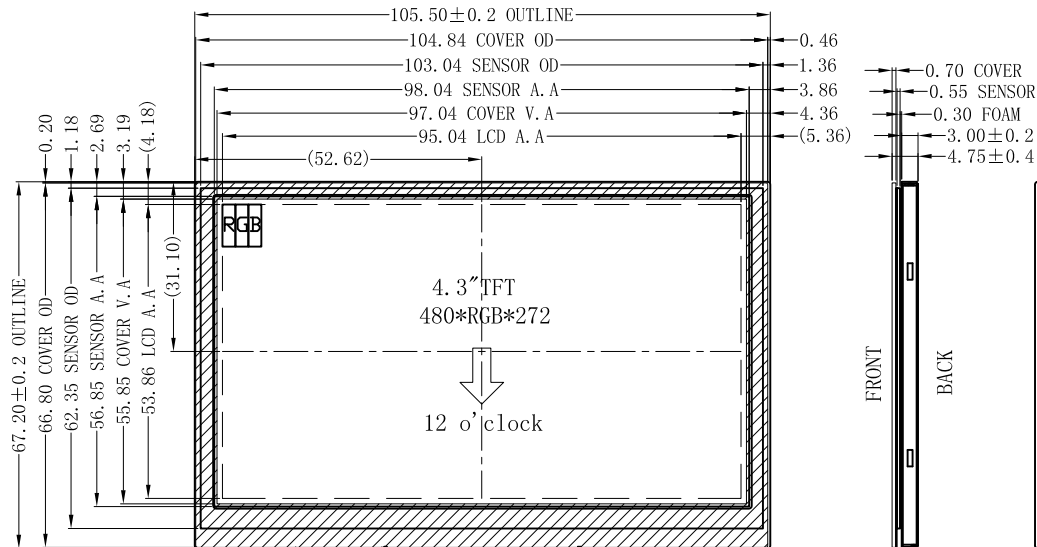

LED CIRCUIT DIAGRAM:

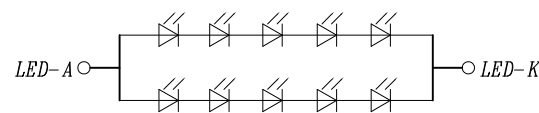

5\*2=10EA If=40mA

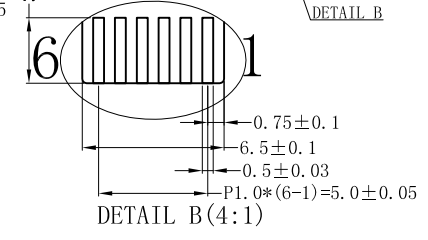
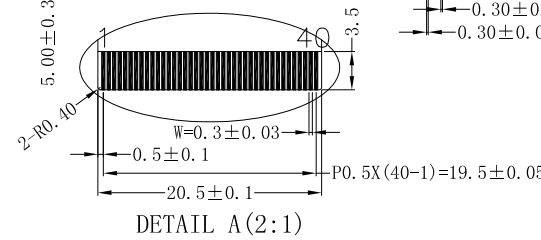

- NOTES:
1. DISPLAY TYPE: 4.3" TFT, TRANSMISSIVE
  2. VIEWING DIRECTION : U/L/D/R 65/65/55/65
  3. Driver IC : ILI6480B
  4. CTP Driver IC : FT5216
  5. Top : -20° C ~ 70° C, Tst : -30° C ~ 80° C
  6. GENERAL TOLERANCE: ±0.2
  7. LCM Luminance: LED/450cd/m<sup>2</sup> (Typical)

PIN FUCTION	
PIN	SYMBOL
1	VLED-
2	VLED+
3	GND
4	VDD
5	R0
6	R1
7	R2
8	R3
9	R4
10	R5
11	R6
12	R7
13	G0
14	G1
15	G2
16	G3
17	G4
18	G5
19	G6
20	G7
21	B0
22	B1
23	B2
24	B3
25	B4
26	B5
27	B6
28	B7
29	GND
30	PCLK
31	DISP
32	HSYNC
33	VS YNC
34	DE
35	NC
36	GND
37	XR
38	YD
39	XL
40	YU

PIN	DEFINE
1	VDD
2	GND
3	SCL
4	SDA
5	INT
6	WAKE

VER	REVISED DESCRIPTION	DATE	NAME	UNIT:mm	Drawn By	Checked By	Approved By
				DESCRIPTION	TFT COG MODULE		
				PART NO.			
				DRAWING NO.	V0		

## 5. Absolute Maximum Ratings(Ta=25°C)

### 5.1 Electrical Absolute Maximum Ratings.(Vss=0V ,Ta=25°C)

Item	Symbol	Min.	Max.	Unit	Note
Power Supply Voltage	V <sub>DD</sub>	-0.3	3.6	V	1, 2
Logic Signal Input /Output Voltage	V <sub>I/OVCC</sub>	-0.3	V <sub>CC</sub> +0.5	V	
Power Supply Voltage for LCD	V <sub>op</sub>	-	-	V	

Notes:

1. If the module is above these absolute maximum ratings. It may become permanently damaged.  
Using the module within the following electrical characteristic conditions are also exceeded, the module will malfunction and cause poor reliability.
2. V<sub>CC</sub> > V<sub>SS</sub> must be maintained.
3. Please be sure users are grounded when handing LCD Module.

### 5.2 Environmental Absolute Maximum Ratings.

Item	Storage		Operating		Note
	MIN.	MAX.	MIN.	MAX.	
Ambient Temperature	-30°C	80°C	-20°C	70°C	1,2
Humidity	-	-	-	-	3

1. The response time will become lower when operated at low temperature.
2. Background color changes slightly depending on ambient temperature.  
The phenomenon is reversible.
3. Ta<=40°C:85%RH MAX.  
Ta>=40°C:Absolute humidity must be lower than the humidity of 85%RH at 40°C.

## 6. Electrical Specifications and Instruction Code

### 6.1 Electrical characteristics(V<sub>SS</sub>=0V ,Ta=25°C)

Parameter	Symbol	Condition	Min	Typ	Max	Unit	Note
Power supply	VDD	Ta=25°C	3.0	3.3	3.6	V	
Input voltage	'H'	V <sub>IH</sub>	V <sub>CC</sub> =3.3V	0.8V <sub>CC</sub>	-	V <sub>CC</sub>	V
	'L'	V <sub>IL</sub>	V <sub>CC</sub> =3.3V	0	-	0.2V <sub>CC</sub>	V
Current Consumption	I <sub>DD1</sub>	Normal mode	-	15	25	mA	
	I <sub>DD2</sub>	Sleep mode	-	0.05	0.1	mA	
Clock Frequency	f <sub>CLK</sub>	-	-	9	15	MHz	

## 6.2 LED backlight specification(VSS=0V ,Ta=25°C)

Item	Symbol	Condition	Min	Typ	Max	Unit	Note
Supply voltage	Vf	If=20mA	-	15	-	V	
Uniformity	Δ Bp	If=20mA	80			%	
Luminance for LCD (W/o CTP)	Lv	If=20mA	-	500		Cd/m2	

Note:

LED power consumption is around 0.06W.

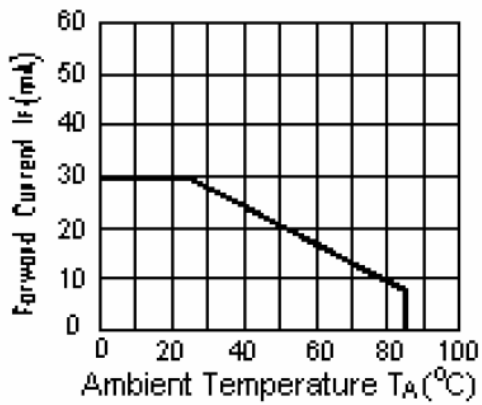

$I_{LED}$  VS TEMP

## 6.3 CTP Electrical characteristics(V<sub>ss</sub>=0V ,T<sub>a</sub>=25°C)

### 6.3.1 Absolute Maximum Ratings

Item	Symbol	Unit	Value	Note
Power Supply Voltage 1	VDDA - VSSA	V	-0.3 ~ +3.6	1, 2
Power Supply Voltage 2	VDD3 – VSS	V	-0.3 ~ +3.6	1, 3
I/O Digital Voltage	IOVCC	V	1.8~3.6	1
Operating Temperature	Topr	°C	-20 ~ +85	1
Storage Temperature	Tstg	°C	-55 ~ +150	1

### 6.3.2 DC Characteristics

Item	Symbol	Unit	Test Condition	Min.	Typ.	Max.	Note
Input high-level voltage	V <sub>IH</sub>	V		0.7IOVCC	--	IOVCC	-
Input low -level voltage	V <sub>IL</sub>	V		-0.3	--	0.3 IOVCC	-
Output high -level voltage	V <sub>OH</sub>	V	I <sub>OH</sub> =-0.1mA	0.7IOVCC	--	--	-
Output low -level voltage	V <sub>OL</sub>	V	I <sub>OH</sub> =0.1mA	--	--	0.3 IOVCC	-
Power Supply voltage	VDDA	VDD3	V	2.8	--	3.6	-



## 6.4 Waveforms

### 6.4.1 Clock and Data Input Waveforms

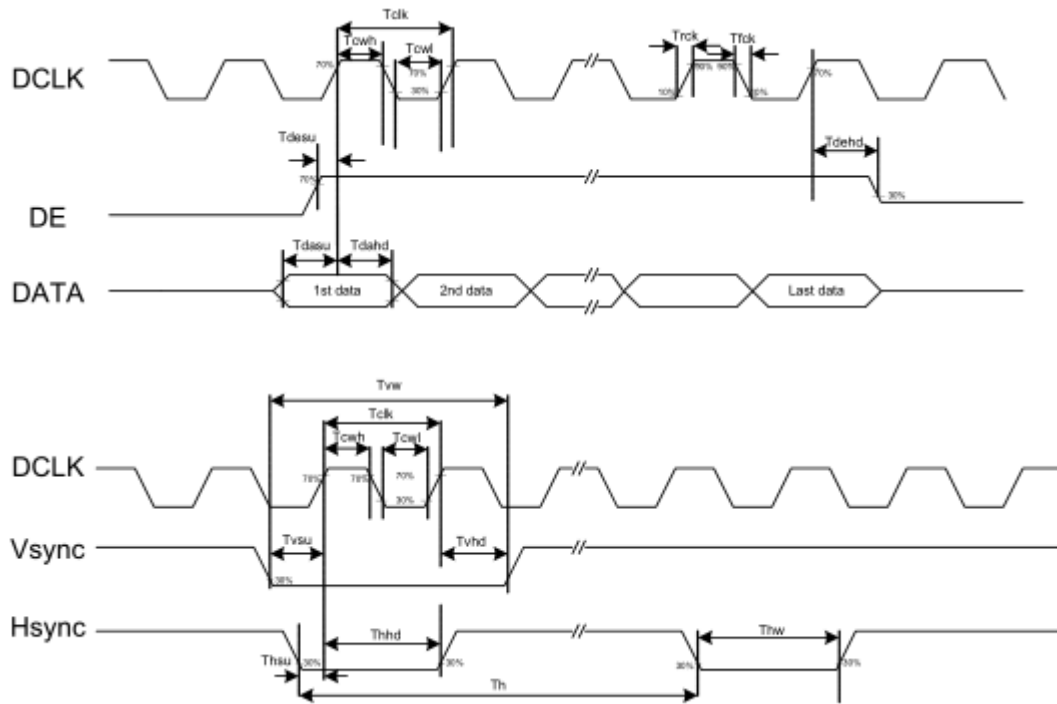

## 6.5 TFT Interface signals

Pin No.	Symbol	I/O	Function
1	VLED-	I	LED back light(Cathode)
2	VLED+	I	LED back light(Anode)
3	GND	P	Ground.
4	VDD	P	Power supply
5-12	R0~R7	I	Red data bus
13-20	G0~G7	I	Green data bus
21-28	B0~B7	I	Blue data bus
29	GND	P	Ground.
30	PCLK	I	Data clock
31	DISP	I	Standby mode select pin
32	HS	I	Line sync signal
33	VS	I	Frame sync signal
34	DE	I	Data enable pin
35	NC	NC	No connection.
36	GND	P	Ground.
37	XR	O	NC
38	YD	O	
39	XL	O	
40	YU	O	

### 6.5.1 CTP Interface signals

Pin No.	Symbol	I/O	Function
1	VDD	P	Power supply
2	GND	P	Ground.
3	SCL	I	serial interface clock
4	SDA	I	serial in/out signal
5	INT	I	Interrupt pin
6	Wake	I	Reset the host

## 7. Optical Characteristics

Item	Symbol	Condition	Min.	Typ.	Max.	Unit	Note	
Brightness (with CTP)	Bp	$\theta=0^\circ$ $\Phi=0^\circ$	-	450	-	Cd/m <sup>2</sup>	1	
Uniformity	$\Delta Bp$		80	-	-	%	1,2	
Viewing Angle	3:00	Cr $\geq$ 10	-	65	-	Deg	3	
	6:00		-	55	-			
	9:00		-	65	-			
	12:00		-	65	-			
Contrast Ratio	Cr	$\theta=0^\circ$ $\Phi=0^\circ$	300	500	-	-	4	
Response Time	T <sub>r</sub>	$\theta=0^\circ$ $\Phi=0^\circ$	-	10	-	ms	5	
	T <sub>f</sub>		-	10	-	ms		
Color of CIE Coordinate	W	x		0.28		-	1,6	
		y		0.33		-		
	R	x		0.51		-		
		y		0.34		-		
	G	x	$\theta=0^\circ$ $\Phi=0^\circ$		0.31			-
		y			0.56			-
	B	x			0.15			-
		y			0.14			-
NTSC Ratio	S		50	60	-	%		

Note: The parameter is slightly changed by temperature, driving voltage and material

Note 1: The data are measured after LEDs are turned on for 5 minutes. LCM displays full white. The brightness is the average value of 9 measured spots. Measurement equipment PR-705 ( $\Phi$ 8mm)

Measuring condition:

- Measuring surroundings: Dark room.
- Measuring temperature: Ta=25°C.
- Adjust operating voltage to get optimum contrast at the center of the display.

Measured value at the center point of LCD panel after more than 5 minutes while backlight turning on.

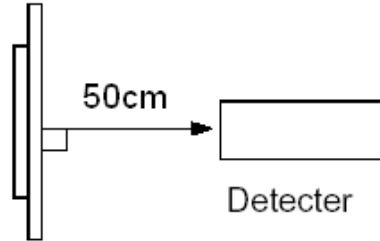

Note 2: The luminance uniformity is calculated by using following formula.

$$\Delta Bp = Bp (\text{Min.}) / Bp (\text{Max.}) \times 100 (\%)$$

$Bp (\text{Max.})$  = Maximum brightness in 9 measured spots

$Bp (\text{Min.})$  = Minimum brightness in 9 measured spots.

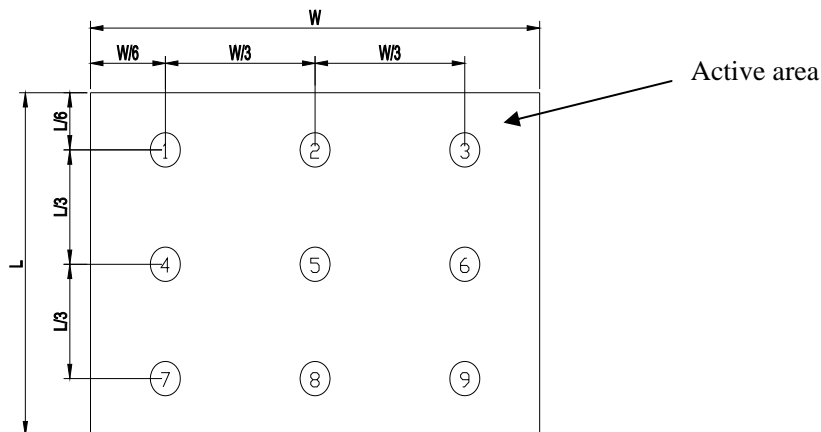

Note 3: The definition of viewing angle:

Refer to the graph below marked by  $\theta$  and  $\phi$

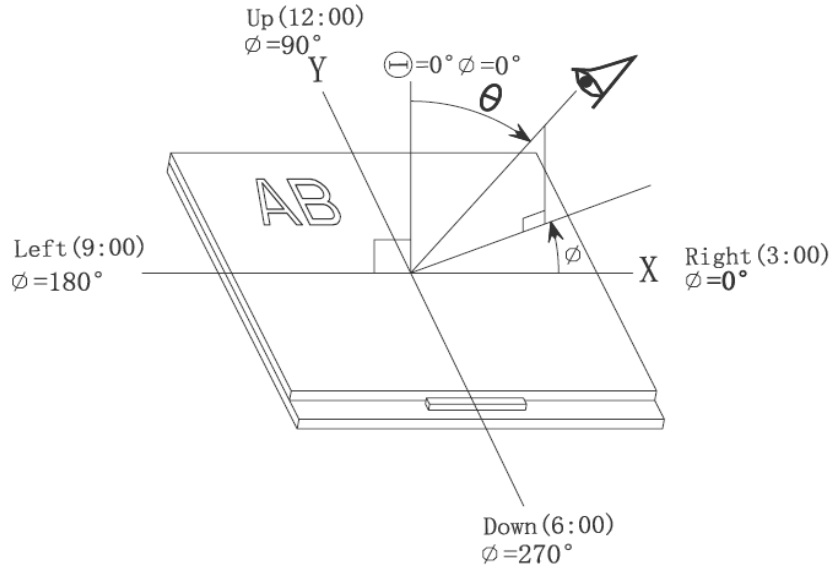

Note 4: Definition of contrast ratio.( Test LCD using DMS501)

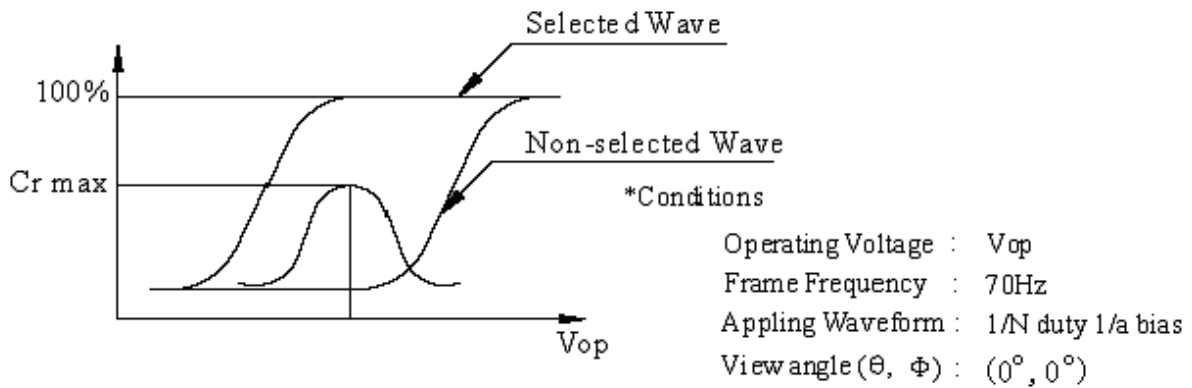

$$\text{Contrast ratio}(Cr) = \frac{\text{Brightness of selected dots}}{\text{Brightness of non-selected dots}}$$

Note 5: Definition of Response time. (Test LCD using DMS501):

The output signals of photo detector are measured when the input signals are changed from “black” to “white”(falling time) and from “white” to “black”(rising time), respectively. The response time is defined as the time interval between the 10% and 90% of amplitudes. Refer to figure as below.

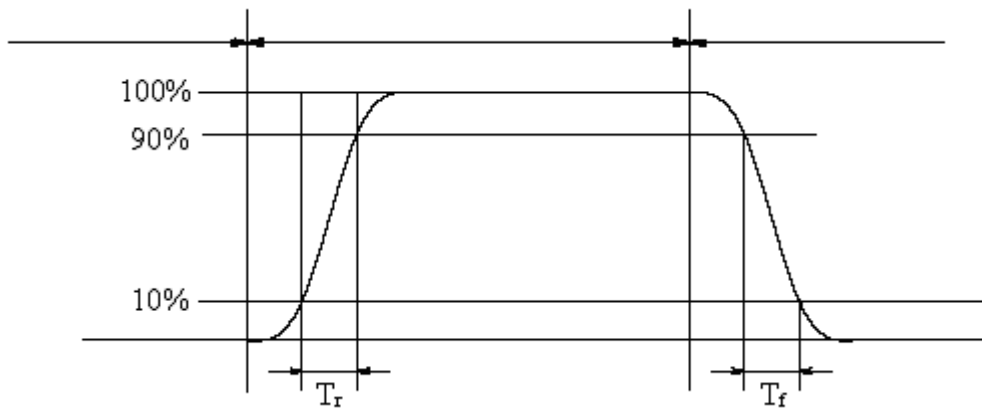

The definition of response time

Note 6: Definition of Color of CIE Coordinate and NTSC Ratio.

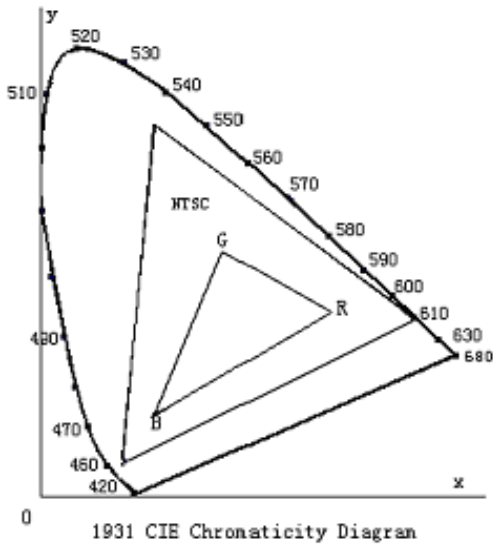

Color gamut:

$$S = \frac{\text{area of RGB triangle}}{\text{area of NTSC triangle}} \times 100\%$$

Note 7: Definition of cross talk.

$$\text{Cross talk ratio(\%)} = \frac{|\text{pattern A Brightness} - \text{pattern B Brightness}|}{\text{pattern A Brightness}} \times 100$$

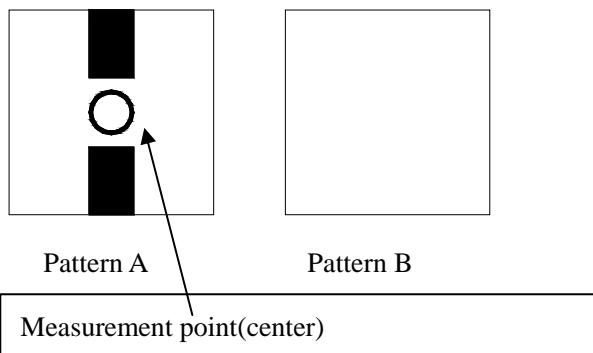

Electric volume value=3F+/-3Hex

## 8. Reliability Test Items and Criteria

No	Test Item	Test condition	Criterion
1	High Temperature Storage	80°C±2°C 96H Restore 2H at 25°C Power off	1. After testing, cosmetic and electrical defects should not happen. 2. Total current consumption should not be more than twice of initial value.
2	Low Temperature Storage	-30°C±2°C 96H Restore 2H at 25°C Power off	
3	High Temperature Operation	70°C±2°C 96H Restore 2H at 25°C Power on	
4	Low Temperature Operation	-20°C±2°C 96H Restore 4H at 25°C Power on	
5	High Temperature/Humidity Operation	60°C±2°C 90%RH 96H Power on	
6	Temperature Cycle	-30°C → 80°C 30min 5min 30min after 5 cycle, Restore 2H at 25°C Power off	
7	Vibration Test	10Hz~150Hz, 100m/s <sup>2</sup> , 120min	Not allowed cosmetic and electrical defects.
8	Shock Test	Half- sine wave, 300m/s <sup>2</sup> , 11ms	

Note: Operation: Supply 2.8V for logic system.

The inspection terms after reliability test, as below

ITEM	Inspection
Contrast	CR>50%
IDD	IDD<200%
Brightness	Brightness>60%
Color Tone	Color Tone+/-0,05

## 9. Precautions for Use of LCD Modules

### 9.1 Handling Precautions

9.1.1 The display panel is made of glass. Do not subject it to a mechanical shock by dropping it from a high place, etc.

9.1.2 If the display panel is damaged and the liquid crystal substance inside it leaks out, be sure not to get any in your mouth, if the substance comes into contact with your skin or clothes, promptly wash it off using soap and water.

9.1.3 Do not apply excessive force to the display surface or the adjoining areas since this may cause the color tone to vary.

9.1.4 The polarizer covering the display surface of the LCD module is soft and easily scratched. Handle this polarizer carefully.

9.1.5 If the display surface is contaminated, breathe on the surface and gently wipe it with a soft dry cloth. If still not completely clear, moisten cloth with one of the following solvents:

- Isopropyl alcohol
- Ethyl alcohol

Solvents other than those mentioned above may damage the polarizer.

Especially, do not use the following:

- Water
- Ketone
- Aromatic solvents

9.1.6 Do not attempt to disassemble the LCD Module.

9.1.7 If the logic circuit power is off, do not apply the input signals.

9.1.8 To prevent destruction of the elements by static electricity, be careful to maintain an optimum work environment.

- a. Be sure to ground the body when handling the LCD Modules.
- b. Tools required for assembly, such as soldering irons, must be properly ground.
- c. To reduce the amount of static electricity generated, do not conduct



assembly and other work under dry conditions.

- d. The LCD Module is coated with a film to protect the display surface. Be care when peeling off this protective film since static electricity may be generated.

## **9.2 Storage precautions**

9.2.1 When storing the LCD modules, avoid exposure to direct sunlight or to the light of fluorescent lamps.

9.2.2 The LCD modules should be stored under the storage temperature range. If the LCD modules will be stored for a long time, the recommend condition is:

Temperature :         $0^{\circ}\text{C} \sim 40^{\circ}\text{C}$

Relatively humidity:  $\leq 80\%$

9.2.3 The LCD modules should be stored in the room without acid, alkali and harmful gas.

**9.3 The LCD modules should be no falling and violent shocking during transportation, and also should avoid excessive press, water, damp and sunshine.**