

Specification	
Part Number:	MCT043LCA0TW480272LML
Version:	1
Date:	13/04/2016
Revision	
0/00000 2016/04/13/0000	First issue

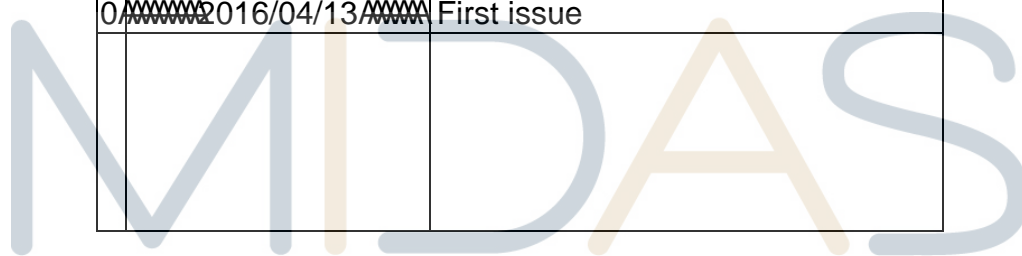

Contents

1.Module Classification Information

2.Summary

3.General Specification

4.Interface

5.Contour Drawing

6.Block Diagram

7.Absolute Maximum Ratings

8.Electrical Characteristics

9.DC Characteristics

10.Interface Timing Characteristics

11.Optical Characteristics

12.Reliability

13.Touch Panel Information

14.Package Specification

15.Initial Code For Reference

16.Other

MIDAS

design • manufacture • supply



Midas Active Matrix Display Part Number System

MC T 057 A 6 * W 320240 L M L * *
1 2 3 4 5 6 7 8 9 10 11 12 13

- 1 = **MC:** Midas Components
- 2 = **T:** TFTA: Active Matrix OLED
- 3 = **Size**
- 4 = **Series**
- 5 = **Viewing Angle:** 6: 6 O'clock 12: 12 O'clock O: All Round Viewing Angle
- 6 = **Blank:** No Touch **T:** Resistive Touchscreen **C:** Capacitive Touchscreen
- 7 = **Operating Temp Range:** **S:** 0+50Deg C **B:** -20+60Deg C
W: -20+70Deg C **E:** -30+85Deg C
X: -30+80Deg C
- 8 = **No of Pixels**
- 9 = **Orientation:** **P:** Portrait **L:** Landscape
- 10 = **Mode:** **R:** Reflective **M:** Transmissive **T:** Transflective
S: Sunlight Readable (Transmissive) **W:** White on Black (Monochrome)
- 11 = **Backlight:** **Blank:** None **L:** LED **C:** CCFL
- 12 = **Blank:** No Module/board **C:** Controller board module (E-Tech)
- 13 = **Blank:** None **OB:** Optically Bonded **IPS:** In-plane switching



2.Summary

This technical specification applies to 4.3' color TFT-LCD panel. The 4.3' color TFT-LCD panel is designed for camcorder, digital camera application and other electronic products which require high quality flat panel displays. This module follows RoHS.



3. General Specifications

- Size: 4.3 inch
- Dot Matrix: 480 x RGBx272(TFT) dots
- Module dimension: 106.7 x 83.98 x 8.5 mm
- Active area: 95.04 x 53.856 mm
- Dot pitch: 0.066 x 0.198 mm
- LCD type: TFT, Normally White, Transmissive
- View Direction: 12 o'clock
- Gray Scale Inversion Direction: 6 o'clock
- Backlight Type: LED, Normally White
- Controller IC: SSD1963
- Interface: Digital 8080 family MPU 8bit/16bit
- With /Without TP: With RTP
- Surface: Anti-Glare

*Color tone slight changed by temperature and driving voltage.



4.Interface

4.1. LCM PIN Definition (CON3)

Pin	Symbol	Function	Remark
1	GND	System round pin of the IC. Connect to system ground.	
2	VDD	Power Supply : +3.3V	
3	BL_E	Backlight control signal , H: On \ L: Off	
4	D/C	Data/Command select	
5	WR	Write strobe signal	
6	RD	Read strobe signal	
7	DB0	Data bus	
8	DB1	Data bus	
9	DB2	Data bus	
10	DB3	Data bus	
11	DB4	Data bus	
12	DB5	Data bus	
13	DB6	Data bus	
14	DB7	Data bus	
15	DB8	Data bus (When select 8bits Mode, this pin is NC)	Note1
16	DB9	Data bus (When select 8bits Mode, this pin is NC)	Note1
17	DB10	Data bus (When select 8bits Mode, this pin is NC)	Note1
18	DB11	Data bus (When select 8bits Mode, this pin is NC)	Note1
19	DB12	Data bus (When select 8bits Mode, this pin is NC)	Note1
20	DB13	Data bus (When select 8bits Mode, this pin is NC)	Note1
21	DB14	Data bus ((When select 8bits Mode, this pin is NC)	Note1
22	DB15	Data bus (When select 8bits Mode, this pin is NC)	Note1
23	NC	No connection	
24	NC	No connection	
25	CS	Chip select	
26	RESET	Hardware reset	
27	DIP ON	Display control H: On \ L:Off	
28	NC	No connection	
29	XL	Left electrode	
30	YU	Top electrode	
31	XR	Right electrode	
32	YD	Bottom electrode	
33	VLED-	VLED- for B/L LED inverter (GND)	
34	VLED-	VLED- for B/L LED inverter (GND)	
35	VLED+	VLED+ for B/L LED inverter (+3.3V)	
36	VLED+	VLED+ for B/L LED inverter (+3.3V)	

Note1: When select 8bit mode, DB0~DB7 be used, DB8~DB15 no connect
When select 16bit mode, DB0~DB15 be used

MIDAS

design • manufacture • supply



5. Contour Drawing

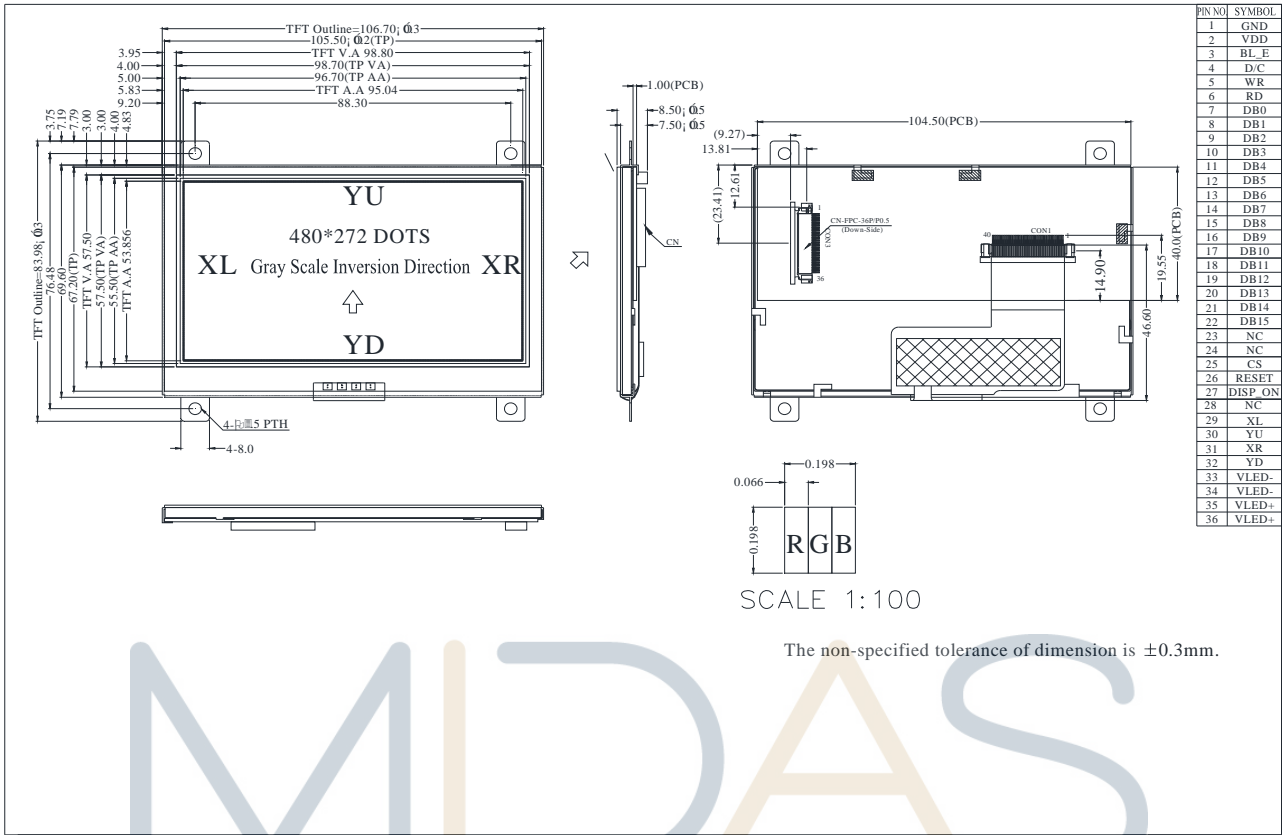

MIDAS

design • manufacture • supply



6. Block Diagram

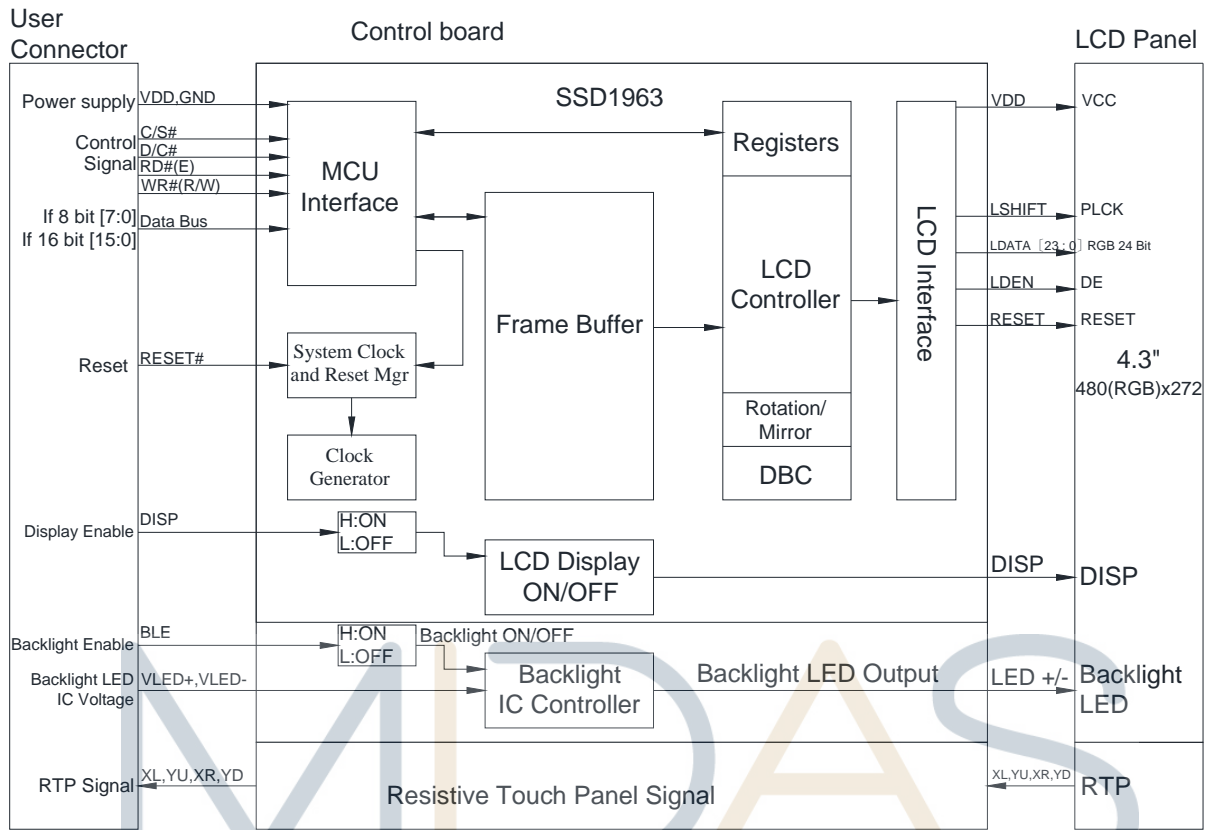

design • manufacture • supply



7. Absolute Maximum Ratings

Item	Symbol	Min	Typ	Max	Unit
Operating Temperature	TOP	-20	—	+70	
Storage Temperature	TST	-30	—	+80	

Note: Device is subject to be damaged permanently if stresses beyond those absolute maximum ratings listed above

- Temp. $\leq 60^{\circ}\text{C}$, 90% RH MAX. Temp. > 60 , Absolute humidity shall be less than 90% RH at 60

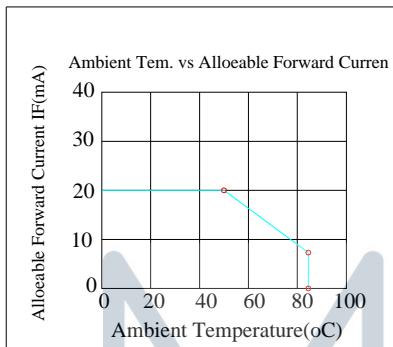

MIDAS

design • manufacture • supply



8. Electrical Characteristics

8.1. Operating conditions: (CON3.Pin1=GND, Pin2=VDD)

Item	Symbol	Condition	Min	Typ	Max	Unit	Remark
Supply Voltage For LCM	VDD	—	3.0	3.1	3.3	V	-
Supply Current For LCM	IDD	—	—	200	300	mA	Note1

Note 1 : This value is test for VDD=3.3V , Ta=25 only

8.2. Backlight driving conditions (CON3.Pin33,34=VLED-, Pin35,36=VLED+)

Parameter	Symbol	Min.	Typ.	Max.	Unit	Remark
Operation Current For LED Driver	VLED+=3.3V	270	-	405	mA	Note 1,2
Power Consumption	VLED+=3.3V	891	-	1337	mW	Note 1,2
Supply Voltage For LED Driver	VLED+	3.3	-	5	V	Note 1,2
LED Life Time		-	50,000	-	Hr	Note 2,3,4

Note 1 : Base on VLED= 3.3V for the back light driver IC specification

Note 2 : Ta = 25

Note 3 : Brightness to be decreased to 50% of the initial value

Note 4 : The single LED lamp case

MIDAS

design • manufacture • supply



9.DC CHARATERISTICS

Parameter	Symbol	Rating			Unit	Condition
		Min	Typ	Max		
Low level input voltage	V_{IL}	0	-	0.3VDD	V	
High level input voltage	V_{IH}	0.7VDD	-	VDD	V	

MIDAS
design • manufacture • supply



10. Interface timing

10.1. 8080 Mode 8bit/16bit

The 8080 mode MCU interface consist of CS#, D/C#, RD#, WR#, Data Bus signals. This interface use WR# to define a write cycle and RD# for read cycle. If the WR# goes low when the CS# signal is low, the data or command will be latched into the system at the rising edge of WR#. Similarly, the read cycle will start when RD# goes low and end at the rising edge of RD#.

10.2. 8080 Mode Write Cycle

Symbol	Parameter	Min	Typ	Max	Unit
fMCLK	System Clock Frequency	1	-	110	MHz
tMCLK	System Clock Period	1/ fMCLK	-	-	ns
tPWCSH	Control Pulse High Width Write Read	13 30	1.5* tMCLK 3.5* tMCLK	-	ns
tPWCSL	Control Pulse Low Width Write (next write cycle) Write (next read cycle) Read	13 80 80	1.5* tMCLK 9* tMCLK 9* tMCLK	-	ns
tAS	Address Setup Time	1	-	-	ns
tAH	Address Hold Time	2	-	-	ns
tDSW	Write Data Setup Time	4	-	-	ns
tDHW	Write Data Hold Time	1	-	-	ns
tPWLW	Write Low Time	12	-	-	ns
tDHR	Read Data Hold Time	1	-	-	ns
tACC	Access Time	32	-	-	ns
tPWLR	Read Low Time	36	-	-	ns
tR	Rise Time	-	-	0.5	ns
tF	Fall Time	-	-	0.5	ns
tCS	Chip select setup time	2	-	-	ns
tCSH	Chip select hold time to read signal	3	-	-	ns

10.3. Parallel 8080-series Interface Timing Diagram(Write Cycle)

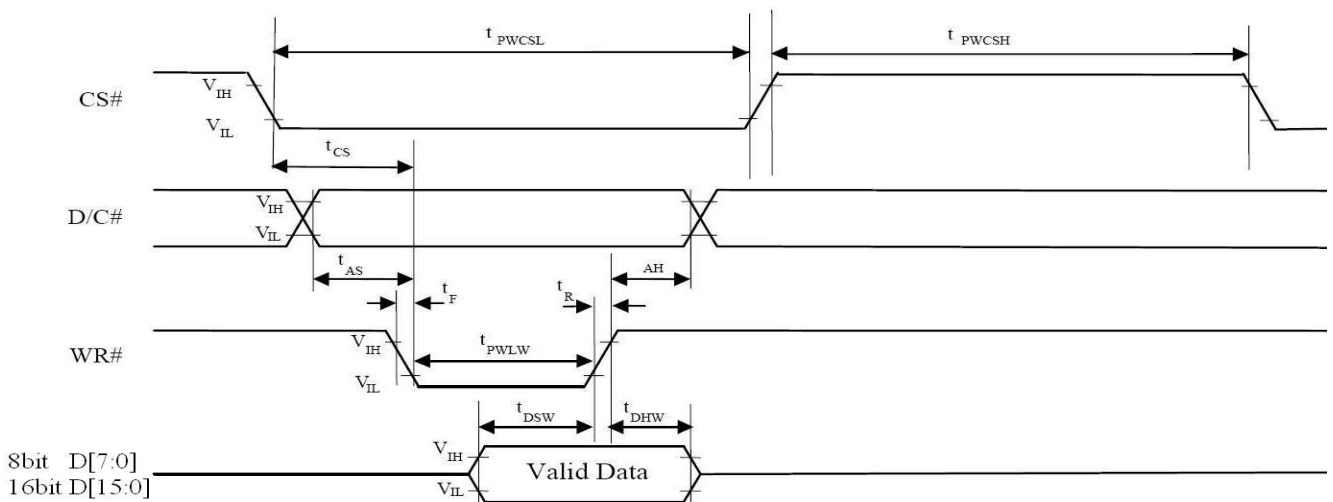

10.4. Parallel 8080-series Interface Timing Diagram(Read Cycle)

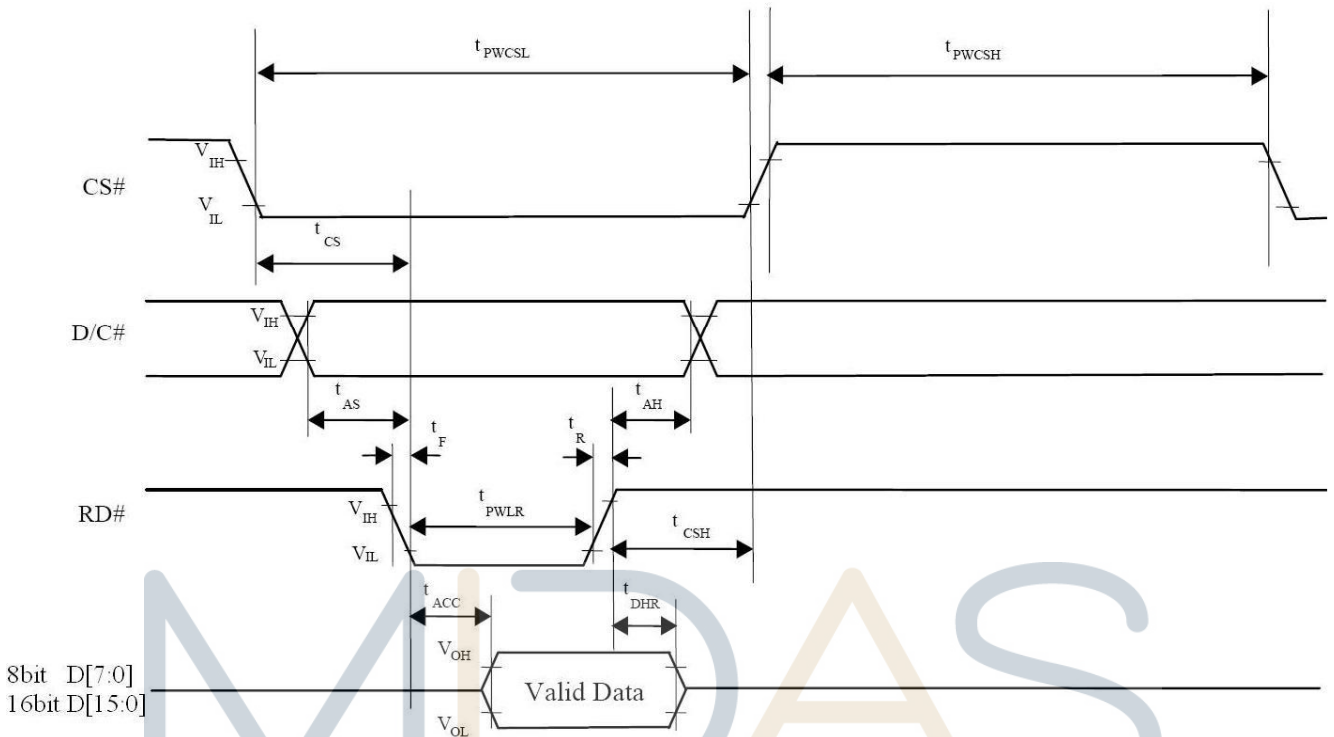

10.5. Pixel Data Format

Interface	Cycle	D[15]	D[14]	D[13]	D[12]	D[11]	D[10]	D[9]	D[8]	D[7]	D[6]	D[5]	D[4]	D[3]	D[2]	D[1]	D[0]
16 bits (565 format)	1 st	R5	R4	R3	R2	R1	G5	G4	G3	G2	G1	G0	B5	B4	B3	B2	B1
16 bits	1 st	R7	R6	R5	R4	R3	R2	R1	R0	G7	G6	G5	G4	G3	G2	G1	G0
	2 nd	B7	B6	B5	B4	B3	B2	B1	B0	R7	R6	R5	R4	R3	R2	R1	R0
	3 rd	G7	G6	G5	G4	G3	G2	G1	G0	B7	B6	B5	B4	B3	B2	B1	B0
8 bits	1 st									R7	R6	R5	R4	R3	R2	R1	R0
	2 nd									G7	G6	G5	G4	G3	G2	G1	G0
	3 rd									B7	B6	B5	B4	B3	B2	B1	B0

11. Optical Characteristics

Item	Symbol	Condition.	Min	Typ.	Max.	Unit	Remark	
Response time	Tr+ Tf	$\theta=0^\circ$ 、 $\Phi=0^\circ$	-	30	45	.ms	Note 3,5	
Contrast ratio	CR	At optimized viewing angle	250	350	-	-	Note 4,5	
Color Chromaticity	White	Wx	$\theta=0^\circ$ 、 $\Phi=0$	0.28	0.30	0.33		Note 2,6,7
		Wy		0.31	0.33	0.36		
Viewing angle (Gray Scale Inversion Direction)	Hor.	Θ_R	CR ≥ 10	-	75	-	Deg.	Note 1
		Θ_L		-	75	-		
	Ver.	Φ_T		-	75	-		
		Φ_B		-	75	-		
Brightness	-	-	200	280	-	cd/m ²	Center of display	

Ta=25±2°C

Note 1: Definition of viewing angle range

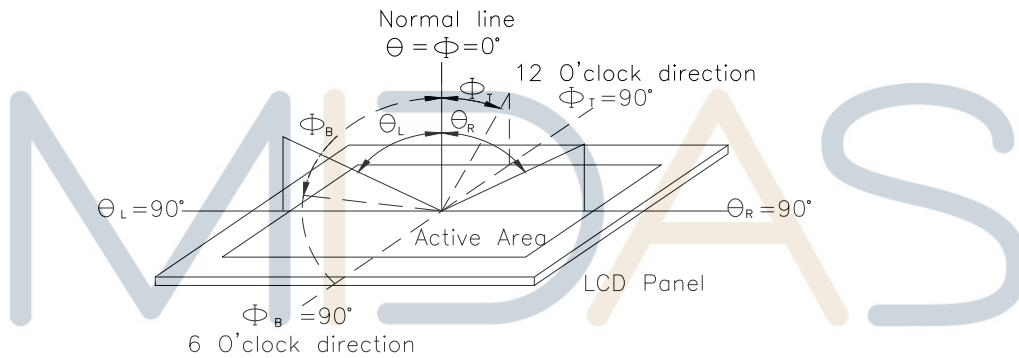

Fig. 11.1. Definition of viewing angle

Note 2: Test equipment setup:

After stabilizing and leaving the panel alone at a driven temperature for 10 minutes, the measurement should be executed. Measurement should be executed in a stable, windless, and dark room. Optical specifications are measured by Topcon BM-7orBM-5 luminance meter 1.0° field of view at a distance of 50cm and normal direction.

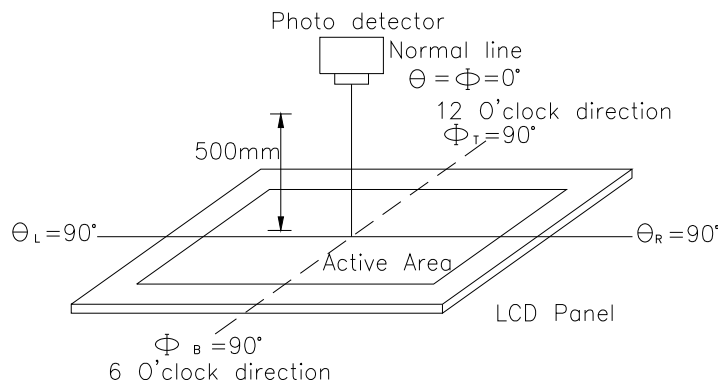
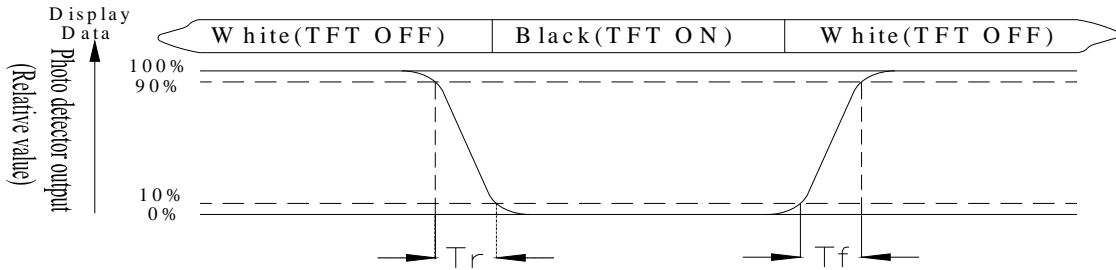

Fig. 11.2. Optical measurement system setup

Note 3: Definition of Response time:

The response time is defined as the LCD optical switching time interval between "White" state and "Black" state. Rise time, T_r , is the time between photo detector output intensity changed from 90% to 10%. And fall time, T_f , is the time between photo detector output intensity changed from 10% to 90%



Note 4: Definition of contrast ratio:

The contrast ratio is defined as the following expression.

$$\text{Contrast ratio (CR)} = \frac{\text{Luminance measured when LCD on the "White" state}}{\text{Luminance measured when LCD on the "Black" state}}$$

Note 5: White $V_i = V_{i50} \pm 1.5V$

Black $V_i = V_{i50} \pm 2.0V$

"±" means that the analog input signal swings in phase with VCOM signal.

"±" means that the analog input signal swings out of phase with VCOM signal.

The 100% transmission is defined as the transmission of LCD panel when all the input terminals of module are electrically opened.

Note 6: Definition of color chromaticity (CIE 1931)

Color coordinates measured at the center point of LCD

Note 7: Measured at the center area of the panel when all the input terminals of LCD panel are electrically opened.

$$\text{Note 8: Uniformity (U)} = \frac{\text{Brightness (min)}}{\text{Brightness (max)}} \times 100\%$$

12. Reliability

Content of Reliability Test (Wide temperature, -20 ~70)

Environmental Test			
Test Item	Content of Test	Test Condition	Note
High Temperature storage	Endurance test applying the high storage temperature for a long time.	80 200hrs	2
Low Temperature storage	Endurance test applying the low storage temperature for a long time.	-30 200hrs	1,2
High Temperature Operation	Endurance test applying the electric stress (Voltage & Current) and the thermal stress to the element for a long time.	70 200hrs	—
Low Temperature Operation	Endurance test applying the electric stress under low temperature for a long time.	-20 200hrs	1
High Temperature/ Humidity Operation	The module should be allowed to stand at 60 ,90%RH max	60 ,90%RH 96hrs	1,2
Thermal shock resistance	The sample should be allowed stand the following 10 cycles of operation <div style="text-align: center;"> <p>-20 25 70</p> <p>30min 5min 30min</p> <p>1 cycle</p> </div>	-20 /70 10 cycles	—
Vibration test	Endurance test applying the vibration during transportation and using.	Total fixed amplitude : 3 15mm Vibration Frequency : 10~55Hz One cycle 60 seconds to 3 directions of X,Y,Z for Each 15 minutes	3
Static electricity test	Endurance test applying the electric stress to the terminal.	VS=±600V(contact) ,±800v(air), RS=330Ω CS=150pF 10 times	—

Note1: No dew condensation to be observed.

Note2: The function test shall be conducted after 4 hours storage at the normal Temperature and humidity after remove from the test chamber.

Note3: The packing have to including into the vibration testing.

13.Touch Panel Information

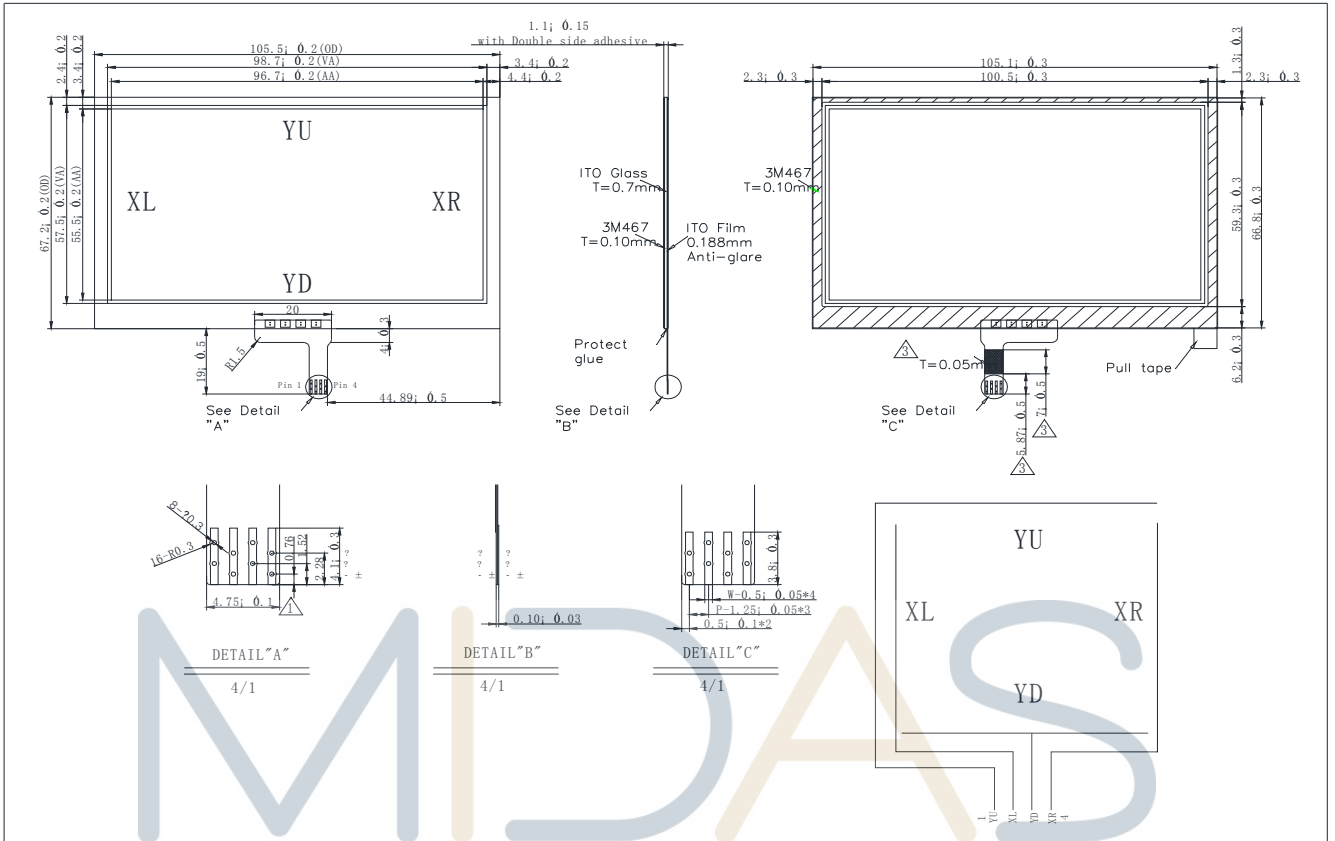

design • manufacture • supply



13.1. Resistance Touch Panel General Specifications

Item	Description
Driving condition	DC5V
Operating force	60~150g
Linearity max	$\leq \pm 1.5\%$
Insulating resistance	$> 20M\Omega$, 25V(DC)
Light transparence	70%
Structure type	ITO Film/ITO Glass(F/G)
Surface Hardness	3H typ
Pen Hitting Durability (with the silicon rubber)	$> 1000,000$ times
X resistance	200~1200 Ω
Y resistance	200~900 Ω

MIDAS

design • manufacture • supply



14.PACKAGE SPECIFICATION

<table border="1" style="width: 100%; border-collapse: collapse;"> <tr> <td style="width: 50%;">LCM Model</td> <td>A7H\$(' @ 5\$HK</td> </tr> <tr> <td>Drawing NO.</td> <td></td> </tr> </table>	LCM Model	A7H\$(' @ 5\$HK	Drawing NO.		<h2 style="margin: 0;">LCM 包裝規格書</h2> <h3 style="margin: 0;">LCM Packaging Specifications</h3>	<table border="1" style="width: 100%; border-collapse: collapse;"> <tr> <td style="width: 33%;">Approve</td> <td style="width: 33%;">Check</td> <td style="width: 33%;">Contact</td> </tr> <tr> <td> </td> <td> </td> <td> </td> </tr> <tr> <td>DATE</td> <td>初版</td> <td>版次 Ver</td> </tr> <tr> <td>14'02/11</td> <td>13'7/12</td> <td>A</td> </tr> </table>	Approve	Check	Contact				DATE	初版	版次 Ver	14'02/11	13'7/12	A
LCM Model	A7H\$(' @ 5\$HK																	
Drawing NO.																		
Approve	Check	Contact																
DATE	初版	版次 Ver																
14'02/11	13'7/12	A																
1.包裝材料規格表 (Packaging Material) :(per carton)																		
NO.	Item	Model	Dimensions	Quantity														
1	成品 (LCM) ****	A7H\$(' @ 5\$HK (, \$&+&@A @		216														
2	TRAY 盤 (2)	PKCA1XXXXXXXXXXXX0350	315mm*265mm	36														
3	BP01 內盒(3)Product Box	PK3Y1XXXXXXXXXXXX0001	332*280*100mm	6														
4	泡棉(4)Foam	-----		6														
5	外紙箱(5)Carton	PK4X1XXXXXXXXXXXX0000	565*340*320mm	1														
6																		
7																		
8																		
9																		
2.單箱數量規格表(Packaging Specifications and Quantity) :																		
(1)LCM quantity per box : no per tray 6 x no of tray 6 = 36																		
(2)Total LCM quantity in carton : quantity per box 36 x no of boxes 6 = 216																		
特 記 事 項 (REMARK)																		
1. Label Specifications :																		
MOOEL: LOT NO : QUANTITY: CHECK:																		



Use empty tray
空盤

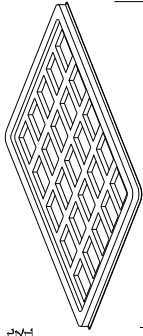

+

Put products into the tray

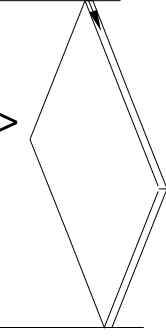
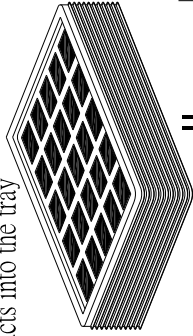

Tray stacking

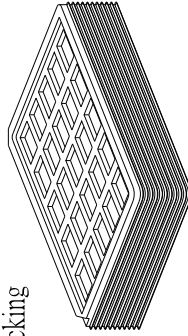

(1) POF

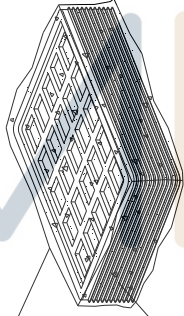

(2) Tray



(4) 泡棉Foam



(3) Product Box

(5) Carton

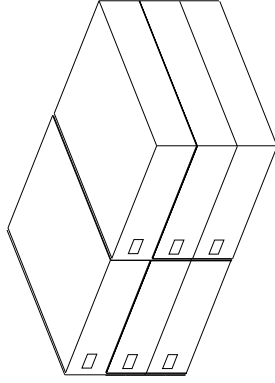
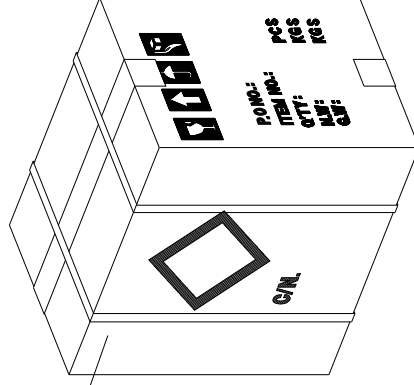

design • manufacture • supply



15.Initial Code For Reference

```
void Initial_code()
{
    Write_Command(0x01);
    Delay_ms(10);
    Write_Command(0xe0);
    Write_Parameter(0x01);
    Delay_ms(50);
    Write_Command(0xe0);
    Write_Parameter(0x03);
    Delay_ms(5);

    Write_Command(0xb0);
    Write_Parameter(0x08);
    Write_Parameter(0x80);
    Write_Parameter(0x01);
    Write_Parameter(0xdf);
    Write_Parameter(0x01);
    Write_Parameter(0x0f);
    Write_Parameter(0x00);

    Write_Command(0xf0);
    Write_Parameter(0x03); //0x03 is 16bit(565 format);0x00 is for 8-bit,pixel data format

    //Set the MN of PLL
    Write_Command(0xe2);
    Write_Parameter(0x1d);
    Write_Parameter(0x02);
    Write_Parameter(0x54);

    Write_Command(0xe6);
    Write_Parameter(0x01);
    Write_Parameter(0x99);
    Write_Parameter(0x9a);

    //Set front porch and back porch
    Write_Command(0xb4);
    Write_Parameter(0x02);
    Write_Parameter(0x0d);
    Write_Parameter(0x00);
    Write_Parameter(0x14);
    Write_Parameter(0x05);
    Write_Parameter(0x00);
    Write_Parameter(0x00);
    Write_Parameter(0x00);

    Write_Command(0xb6);
```



```
Write_Parameter(0x01);  
Write_Parameter(0x24);  
Write_Parameter(0x00);  
Write_Parameter(0x0a);  
Write_Parameter(0x05);  
Write_Parameter(0x00);  
Write_Parameter(0x00);
```

```
Write_Command(0x2a);  
Write_Parameter(0x00);  
Write_Parameter(0x00);  
Write_Parameter(0x01);  
Write_Parameter(0xdf);
```

```
Write_Command(0x2b);  
Write_Parameter(0x00);  
Write_Parameter(0x00);  
Write_Parameter(0x01);  
Write_Parameter(0x0f);
```

```
Write_Command(0x29);  
Write_Command(0x2c);
```

}

MIDAS

design • manufacture • supply

