



Riverdi

our pixels behave

RVT50UQFNWC0x

LCD TFT Datasheet

Rev.1.4

2016-10-17

ITEM	CONTENTS	UNIT
LCD Type	TFT/Transmissive/Normally white	/
Size	5.0	Inch
Viewing Direction	12:00 (without image inversion)	O' Clock
Gray Scale Inversion Direction	6:00	O' Clock
LCM (W × H × D)	136.00×92.80× 9.20	mm ³
Active Area (W × H)	108.00 × 64.80	mm ²
Dot Pitch (W × H)	0.045×0.135	mm ²
Number Of Dots	800 (RGB) × 480	/
Driver IC	FT813	/
Backlight Type	12 LEDs	/
Surface Luminance	510	cd/m ²
Interface Type	SPI/QSPI	/
Color Depth	16.7M	/
Pixel Arrangement	RGB Vertical Stripe	/
Surface Treatment	Clear	/
Input Voltage	3.3	V
With/Without TSP	Projected Capacitive Touch Panel	/
Weight	106.45	g

Note 1: RoHS compliant

Note 2: LCM weight tolerance: ± 5%.



REVISION RECORD

REVNO.	REVDATE	CONTENTS	REMARKS
1.0	2015-11-19	Initial Release	
1.2	2016-02-15	Update LED Backlight Current and Input Voltage for LED Inverter, LCD Timing Characteristics information	
1.3	2016-06-06	Update Interface description (pin 4 and pin 5)	
1.4	2016-10-17	Added Inspection Standards	

CONTENTS

REVISION RECORD.....	2
CONTENTS	2
1 MODULE CLASSIFICATION INFORMATION	3
2 MODULE DRAWING	4
3 ABSOLUTE MAXIMUM RATINGS.....	5
4 ELECTRICAL CHARACTERISTICS.....	5
5 BACKLIGHT CHARACTERISTICS	5
6 ELECTRO-OPTICAL CHARACTERISTICS	5
7 INTERFACE DESCRIPTION	7
8 FT813 CONTROLLER SPECIFICATIONS	8
8.1 Serial host interface.....	8
8.2 Block Diagram.....	9
8.3 Host interface SPI mode 0	9
8.4 Backlight driver block diagram	9
9 LCD TIMING CHARACTERISTICS	10
9.1 Clock and data input time diagram	10
9.2 Parallel RGB timing table.....	10
10 CAPACITIVE TOUCH SCREEN PANEL SPECIFICATIONS	11
10.1 Mechanical characteristics	11
10.2 Electrical characteristics	11
11 ORDERING INFORMATION	12
12 CUSTOMIZATION LEVEL.....	13
13 INSPECTION	14
13.1 Inspection condition.....	14
13.2 Inspection standard.....	15
14 RELIABILITY TEST.....	18
15 INFORMATION.....	19

1 MODULE CLASSIFICATION INFORMATION

RV	T	5Ø	U	Q	F	N	W	C	Øx
1.	2.	3.	4.	5.	6.	7.	8.	9.	10.

1.	BRAND	RV – Riverdi
2.	PRODUCT TYPE	T – TFT Standard F – TFT Custom
3.	DISPLAY SIZE	35 – 3.5” 43 – 4.3” 50 – 5.0” 70 – 7.0”
4.	MODEL SERIAL NO.	U (A-Z)
5.	RESOLUTION	Q– 800x480 px
6.	INTERFACE	T – TFT LCD, RGB L – TFT LCD, LVDS S – TFT + Controller SSD1963 F – TFT+ Controller FT813
7.	FRAME	N – No Frame F – Mounting Frame
8.	BACKLIGHT TYPE	W – LED White
9.	TOUCH PANEL	N – No Touch Panel R – Resistive Touch Panel C – Capacitive Touch Panel
10.	VERSION	0x (00-99)

TFT PINOUT	
PIN	DESC
1	VDD
2	GND
3	SPI_SCLK
4	MISO/IO1
5	MOSI/IO0
6	CS
7	INT
8	PD
9	NC
10	AUDIO_O UT
11	GPIO0/IO 2
12	GPIO1/IO 3
13	GPIO2
14	GPIO3
15	NC
16	NC
17	BLVDD
18	BLVDD
19	BLGND
20	BLGND

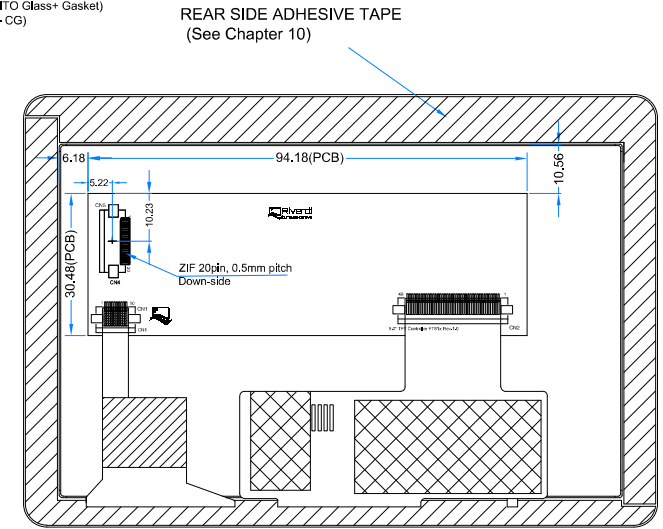
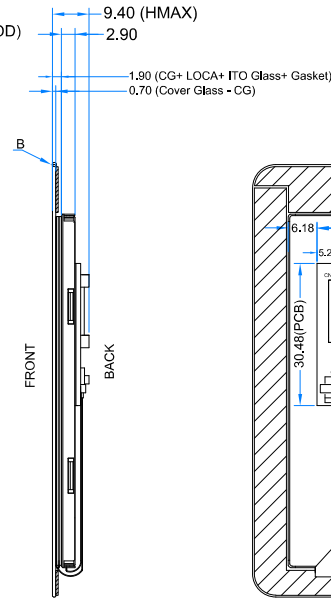
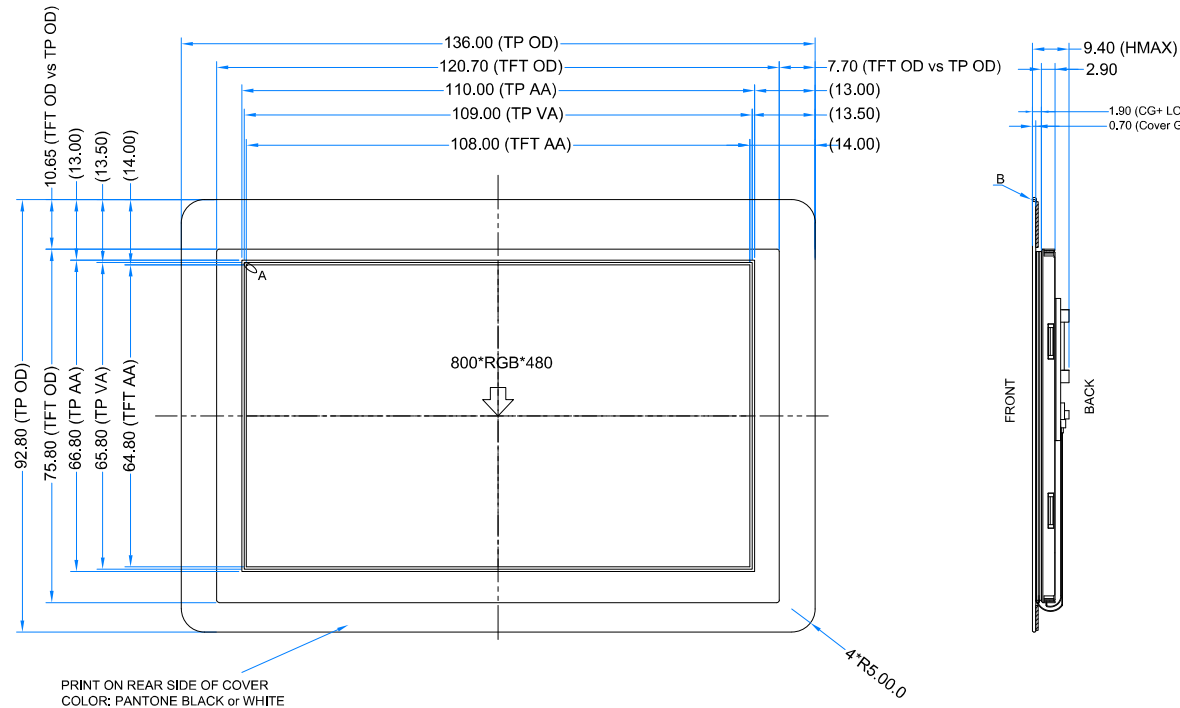

CTP PINOUT	
PIN	DESC
1	VSS
2	VDD
3	SCL
4	NC
5	SDA
6	NC
7	RST
8	WAKE
9	INT
10	VSS

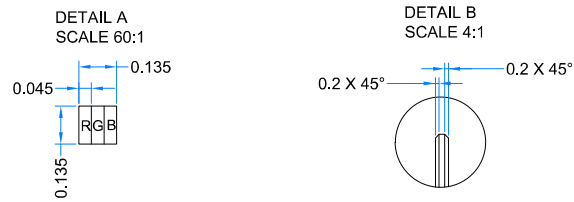
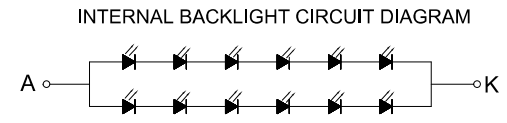

- NOTES:
1. DISPLAY TYPE: TFT, TRANSMISSIVE, NORMALLY WHITE
 2. OPERATING VOLTAGE: VDD=3.3V
 3. VIEWING DIRECTION: 12 O'CLOCK
 4. IC DRIVER: FT813
 5. IC DRIVER CTP : FT5306 (SMT).
 6. OPERATING TEMP: -20°C ~ 70°C
 7. STORAGE TEMP: -30°C ~ 80°C
 8. LED BACKLIGHT: 12 WHITE LED
 9. LCM SURFACE LUMINANCE: 510cd/m²
 10. GENERAL TOLERANCE: ±0.3
 11. RoHS COMPLIANT

Ver.	DESCRIPTION	DATE
1.1	Update pin description	2016.06.06
1.0	Initial case	2015.11.19

CUSTOMER		TITLE	
DRAWN	SCALE 1:1	RVT50UQFNWC0x	
DFTG CHK	UNIT mm	MODEL	
ENGR CHK	APPROVAL	DWG NO	
APPROVAL		PAGE	
		Rev. 1.1	1/1

3 ABSOLUTE MAXIMUM RATINGS

PARAMETER	SYMBOL	MIN	MAX	UNIT
Supply Voltage For Logic	VDD	-0.3	4.0	V
Input Voltage For Logic	VIN	VSS-0.5	VDD+0.3	V
LED forward current (each LED)	IF	-	60	mA
Operating Temperature	T _{OP}	-20	70	°C
Storage Temperature	T _{ST}	-30	80	°C
Humidity	RH	-	90% (Max 60°C)	RH

4 ELECTRICAL CHARACTERISTICS

PARAMETER	SYMBOL	MIN	TYP	MAX	UNIT	NOTES
Supply Voltage For Module	VDD	3.0	3.3	3.6	V	
Input Leakage Current	I _{LKG}	-	-	-	μA	
Input Voltage for LED Inverter	BLVDD	2.8	3.3	5.5	V	
LED Backlight Current	IDD _{backlight}	-	290	363	mA	BLVDD=3.3V
LED Backlight Current	IDD _{backlight}	-	180	225	mA	BLVDD=5V
Input Voltage 'H' level	V _{IH}	0.8VDD	-	VDD	V	
Input Voltage 'L' level	V _{IL}	-0.3	-	0.2VDD	V	

5 BACKLIGHT CHARACTERISTICS

ITEM	SYMBOL	MIN	TYP	MAX	UNIT
Voltage for LED backlight	V _I	17.4	18.3	19.6	V
Current for LED backlight	I _I	30	40	50	mA
Power consumption	W _{BL}	522	732	980	mW
LED Life Time	-	30000	50000	-	Hrs

Note: The LED life time is defined as the module brightness decrease to 50% original brightness at Ta=25°C.

6 ELECTRO-OPTICAL CHARACTERISTICS

ITEM	SYMBOL	CONDITION	MIN	TYP	MAX	UNIT	REMARK	NOTE
Response Time	Tr+Tf		-	20	-	ms	Figure 1	4
Contrast Ratio	Cr	θ=0°	-	500	-	---	Figure 2	1
Luminance Uniformity	δ WHITE	φ=0° Ta=25	75	80	-	%	Figure 2	3
Surface Luminance	Lv		467	510	-	cd/m ²	Figure 2	2
Viewing Angle Range	θ	φ = 90°	40	50	-	deg	Figure 3	6
		φ = 270°	60	70	-	deg	Figure 3	
		φ = 0°	60	70	-	deg	Figure 3	
		φ = 180°	60	70	-	deg	Figure 3	
CIE (x, y) Chromaticity	Red	x	0.540	0.590	0.640	Figure 2	5	
		y	0.300	0.350	0.400			
	Green	x	0.298	0.348	0.398			
		y	0.520	0.570	0.620			
	Blue	x	0.095	0.145	0.195			
		y	0.060	0.110	0.160			
	White	x	0.270	0.320	0.370			
		y	0.310	0.360	0.410			

Note 1. Contrast Ratio(CR) is defined mathematically as below, for more information see Figure 1.

$$\text{Contrast Ratio} = \frac{\text{Average Surface Luminance with all white pixels (P1, P2, P3, P4, P5)}}{\text{Average Surface Luminance with all black pixels (P1, P2, P3, P4, P5)}}$$

Note 2. Surface luminance is the LCD surface from the surface with all pixels displaying white. For more information see Figure 2.

L_v = Average Surface Luminance with all white pixels (P1, P2, P3, P4, P5)

Note 3. The uniformity in surface luminance δ WHITE is determined by measuring luminance at each test position 1 through 5, and then dividing the maximum luminance of 5 points luminance by minimum luminance of 5 points luminance. For more information see Figure 2.

$$\delta \text{ WHITE} = \frac{\text{Minimum Surface Luminance with all white pixels (P1, P2, P3, P4, P5)}}{\text{Maximum Surface Luminance with all white pixels (P1, P2, P3, P4, P5)}}$$

Note 4. Response time is the time required for the display to transition from white to black (Rise Time, T_r) and from black to white (Decay Time, T_f). For additional information see FIG 1. The test equipment is Autronic-Melchers's ConoScope series.

Note 5. CIE (x, y) chromaticity, the x, y value is determined by measuring luminance at each test position 1 through 5, and then make average value.

Note 6. Viewing angle is the angle at which the contrast ratio is greater than 2. For TFT module the contrast ratio is greater than 10. The angles are determined for the horizontal or x axis and the vertical or y axis with respect to the z axis which is normal to the LCD surface. For more information see Figure 3.

Note 7. For viewing angle and response time testing, the testing data is based on Autronic-Melchers's ConoScope series. Instruments for Contrast Ratio, Surface Luminance, Luminance Uniformity, CIE the test data is based on TOPCON's BM-5 photo detector.

Note 8. For TFT module, Gray scale reverse occurs in the direction of panel viewing angle.

Figure 1. The definition of response time

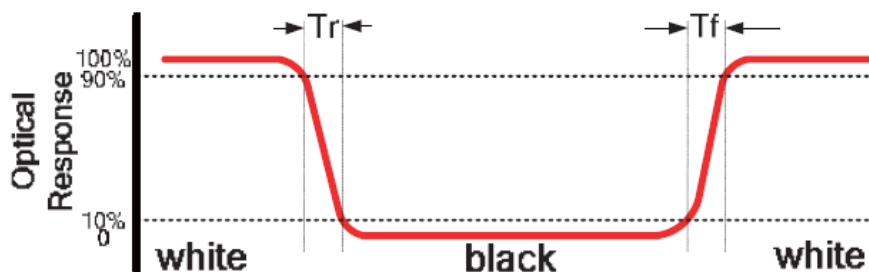

Figure 2. Measuring method for Contrast ratio, surface luminance, Luminance uniformity, CIE (x, y) chromaticity

A : 5 mm
 B : 5 mm
 H, V : Active Area
 Light spot size $\varnothing=5\text{mm}$, 500mm distance from the LCD surface to detector lens
 measurement instrument is TOPCON's luminance meter BM-5

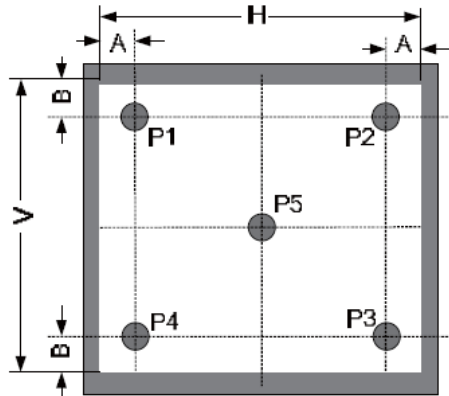
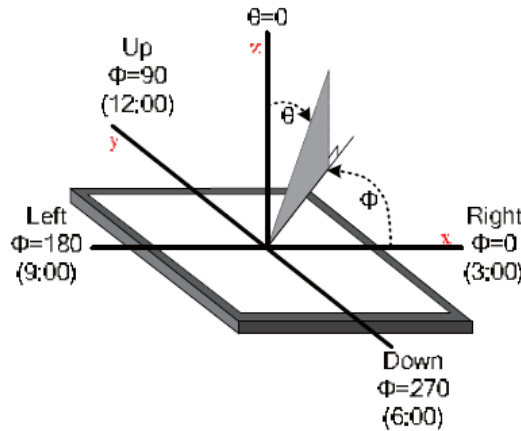

Figure 3. The definition of viewing angle



7 INTERFACE DESCRIPTION

PIN NO.	SYMBOL	DESCRIPTION
1	VDD	Power Supply
2	GND	Ground
3	SPI_SCLK	SPI SCK Signal, Internally 47k Pull UP
4	MISO/ IO1	SPI MISO Signal / SPI Quad mode: SPI data line 1
5	MOSI/ IO0	SPI MOSI Signal / SPI Quad mode: SPI data line 0
6	CS	SPI Chip Select Signal , Internally 47k Pull UP
7	INT	Interrupt Signal, Active Low, Internally 47k Pull UP
8	PD	Power Down Signal, Active Low, Internally 47k Pull UP
9	NC	Not Connected
10	AUDIO_OUT	Audio Out Signal
11	GPIO0/IO2	SPI Single mode: General purpose IO0/ SPI Quad mode: SPI data line 2
12	GPIO1/IO3	SPI Single mode: General purpose IO1/ SPI Quad mode: SPI data line 3
13	GPIO2	General purpose IO2
14	GPIO3	General purpose IO3 or analog input for ADC
15	NC	Not Connected
16	NC	Not Connected
17	BLVDD	Backlight Power Supply, Can Be Connected to VDD
18	BLVDD	Backlight Power Supply, Can Be Connected to VDD
19	BLGND	Backlight Ground, Internally connected to GND
20	BLGND	Backlight Ground, Internally connected to GND

8 FT813 CONTROLLER SPECIFICATIONS

FT813 or EVE (Embedded Video Engine) simplifies the system architecture for advanced human machine interfaces (HMIs) by providing functionality for display, audio, and touch as well as an object oriented architecture approach that extends from display creation to the rendering of the graphics.

8.1 Serial host interface

Figure 4. SPI interface connection

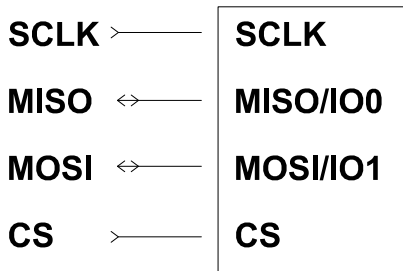
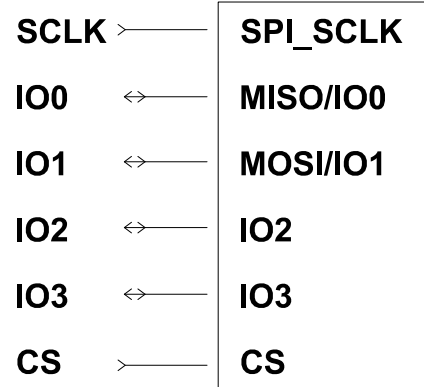

Figure 5. QSPI interface connection



SPI Interface – the SPI slave interface operates up to 30MHz.

Only SPI mode 0 is supported. The SPI interface is selected by default (MODE pin is internally pulled low by 47k resistor).

QSPI Interface – the QSPI slave interface operates up to 30MHz. Only SPI mode 0 is supported. The QSPI can be configured as a SPI slave in SINGLE, DUAL or QUAD data bus modes.

By default the SPI slave operates in the SINGLE channel mode with MOSI as input from the master and MISO as output to the master. DUAL and QUAD channel modes can be configured through the SPI slave itself. To change the channel modes, write to register REG_SPI_WIDTH.

8.2 Block Diagram

Figure 6. FT813 Block diagram

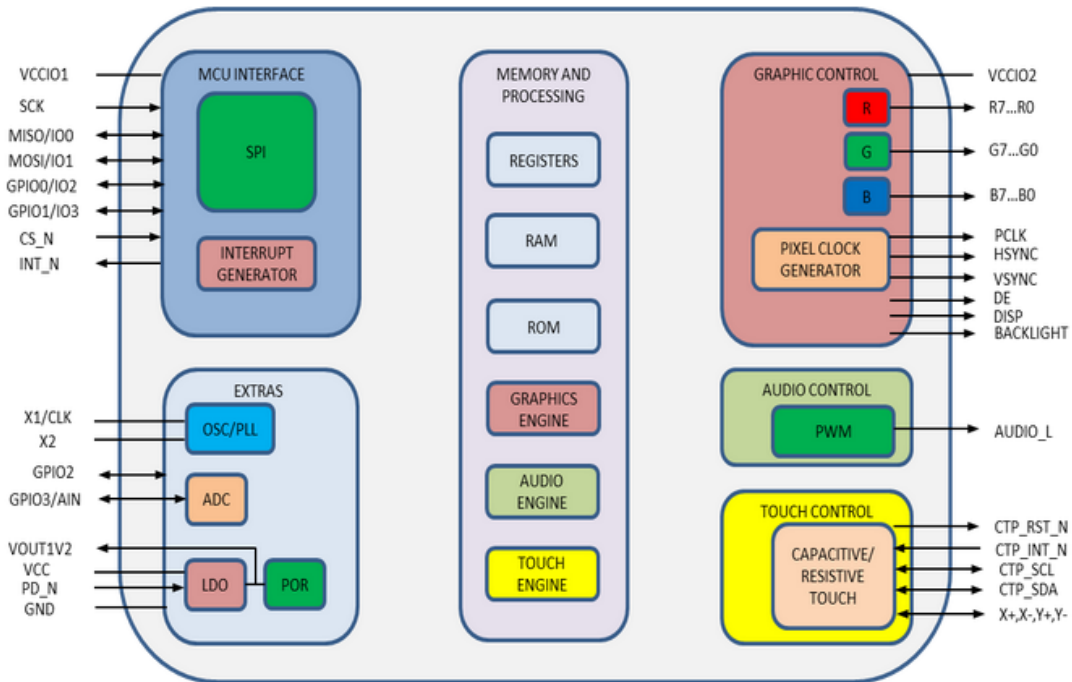

8.3 Host interface SPI mode 0

Figure 7. SPI timing diagram

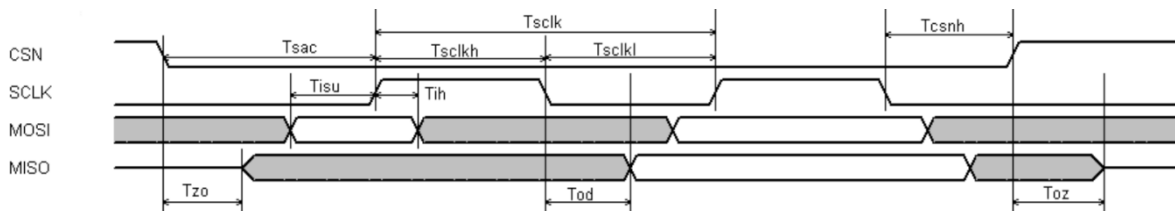

For more information about FT813 controller please go to official FT81x website <http://www.ftdichip.com/Products/ICs/FT81X.html>

8.4 Backlight driver block diagram

Backlight enable signal is internally connected to FT813 Backlight control pin. This pin is controlled by two FT813's registers. One of them specifies the PWM output frequency, second one specifies the duty cycle. Refer to FT813 datasheet for more information.

Figure 8. Backlight driver block diagram

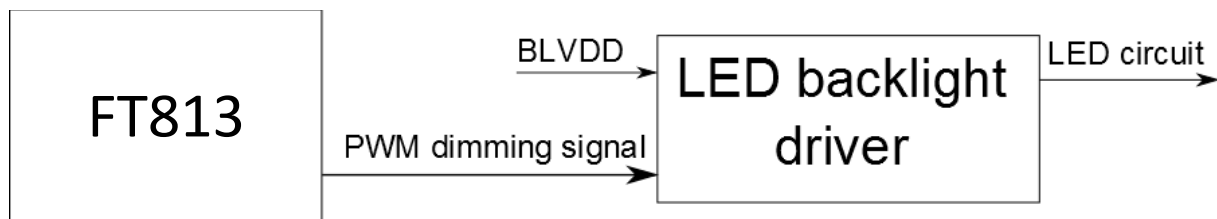

9 LCD TIMING CHARACTERISTICS

9.1 Clock and data input time diagram

Figure 9. Horizontal input timing diagram

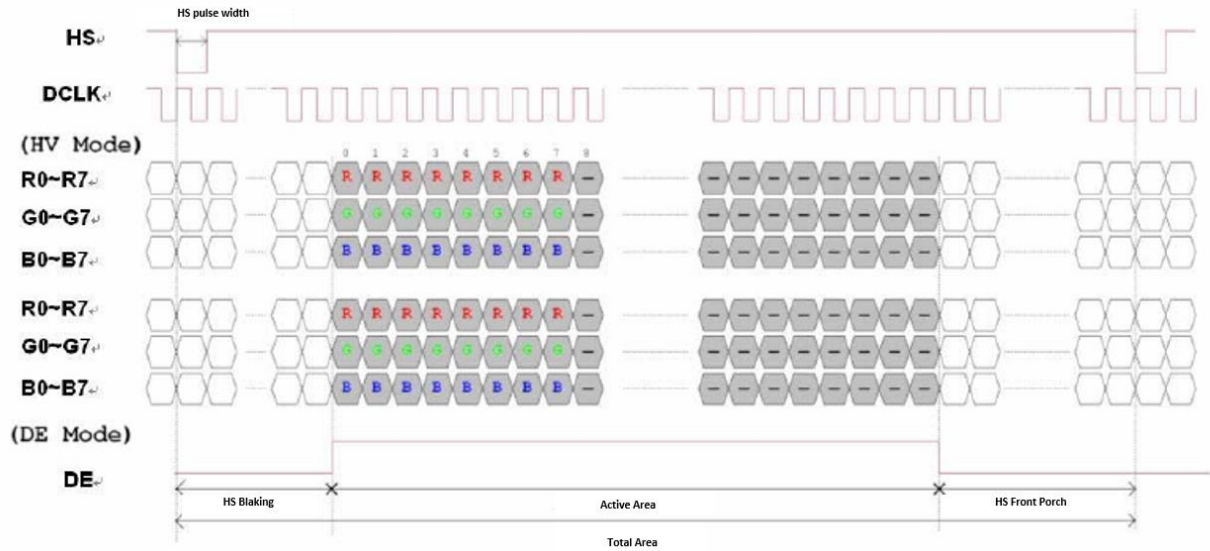
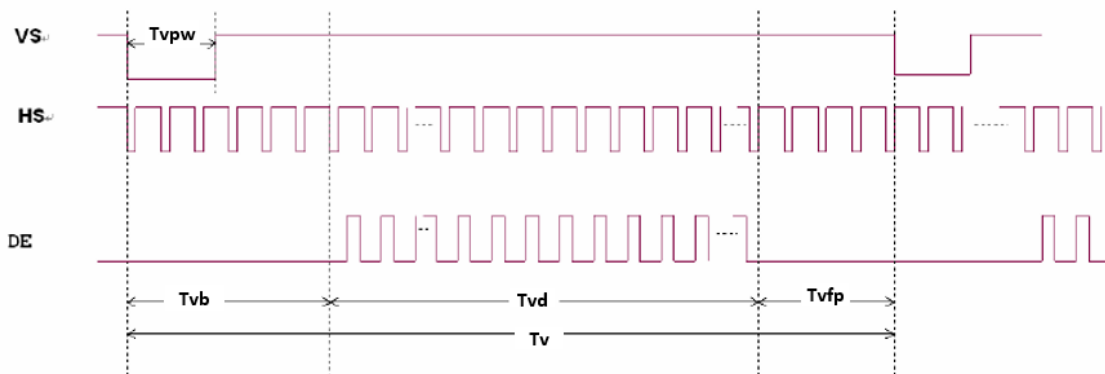

Figure 10. Vertical input timing diagram



9.2 Parallel RGB timing table

PARAMETER	SYMBOL	MIN	TYP	MAX	UNIT
Horizontal Display Area	Thd	-	800	-	DCLK
DCLK Frequency	Fclk	-	30	50	MHz
One Horizontal Line	Th	889	928	1143	DCLK
HS pulse width	Thpw	1	48	255	DCLK
HS Blanking	Thb	-	88	-	DCLK
HS Front Porch	Thfp	1	40	255	DCLK
Vertical Display Area	Tvd	-	480	-	TH
VS period time	Tv	513	525	767	TH
VS pulse width	Tvpw	3	3	255	TH
VS Blanking	Tvfb	-	32	-	TH
VS Front Porch	Tvfp	1	13	255	TH

10 CAPACITIVE TOUCH SCREEN PANEL SPECIFICATIONS

The Capacitive Touch Panel is directly connected to FT813 module. Therefore communication with Capacitive Touch Panel is simplified to read registers of FT813.

Figure 11. Capacitive Touch Panel Connection

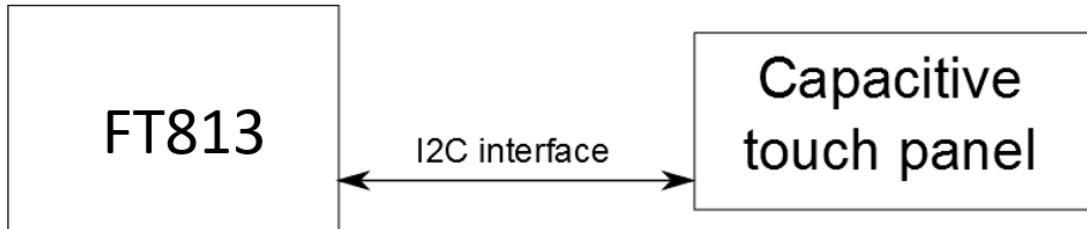

10.1 Mechanical characteristics

DESCRIPTION	INL SPECIFICATION	REMARK
Touch Panel Size	5.0 inch	
Outline Dimension (OD)	136.0mm x 92.8mm	Cover Lens Outline
Product Thickness	1.9mm	
Glass Thickness	0.7mm	
Ink View Area	109.00mm x 65.80mm	
Sensor Active Area	110.0mm x 66.8mm	
Input Method	5 Finger	
Activation Force	Touch	
Surface Hardness	≥7H	

10.2 Electrical characteristics

DESCRIPTION	SPECIFICATION	
Operating Voltage	DC 2.8~3.3V	
Power Consumption (IDD)	Active Mode	TBD mA
	Sleep Mode	TBD μA
Interface	I ² C	
Controller	FT5306	
I2C address	0x38 (7 bit address)	
Resolution	800*480	

11 ORDERING INFORMATION

Three options of rear side adhesive tape are available: double side adhesive tape 0.2 mm with 3M 467MP glue, foam double side adhesive tape 0.5 mm with 3M 467MP glue or without any tape. There are also two versions of glass color: black and white.

Rear side adhesive tape options:



Cover glass color options:

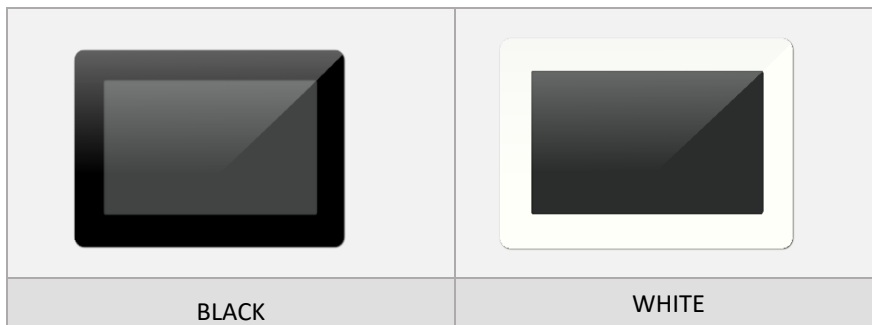

Product options:

PN	DESCRIPTION
RVT50UQFNWC00	<ul style="list-style-type: none"> • Double side adhesive tape with 3M 9495LE glue (total thickness 0.2mm) • Cover glass color- black
RVT50UQFNWC01	<ul style="list-style-type: none"> • Foam double side adhesive tape with 3M 9495LE glue (total thickness 0.5mm) • Cover glass - black
RVT50UQFNWC02	<ul style="list-style-type: none"> • Without tape • Cover glass color- black
RVT50UQFNWC03	<ul style="list-style-type: none"> • Double side adhesive tape with 3M 9495LE glue (total thickness 0.2mm) • Cover glass color- white
RVT50UQFNWC04	<ul style="list-style-type: none"> • Foam double side adhesive tape with 3M 9495LE glue (total thickness 0.5mm) • Cover glass color- white
RVT50UQFNWC05	<ul style="list-style-type: none"> • Without tape • Cover glass color- white

12 CUSTOMIZATION LEVEL

Beside standard product (**BASIC LEVEL**), there are two levels of product customization available:

1. **ADVANCED LEVEL**
2. **PROFESSIONAL LEVEL**

Basic level - standard version of product with black or white cover glass color.

Advanced level- product with modified cover glass color, company logo or with special transparent spots for diodes.



Professional level- product with changed panel parameters including glass dimension and shapes.



For more information go to <http://riverdi.com/uxtouch/>.

13 INSPECTION

Standard acceptance/rejection criteria for TFT module.

13.1 Inspection condition

Ambient conditions:

- Temperature: $25\pm^{\circ}\text{C}$
- Humidity: $(60\pm 10)\% \text{RH}$
- Illumination: Single fluorescent lamp non-directive (300 to 700 lux)

Viewing distance:

$35\pm 5\text{cm}$ between inspector bare eye and LCD.

Viewing Angle:

U/D: $45^{\circ}/45^{\circ}$, L/R $45^{\circ}/45^{\circ}$

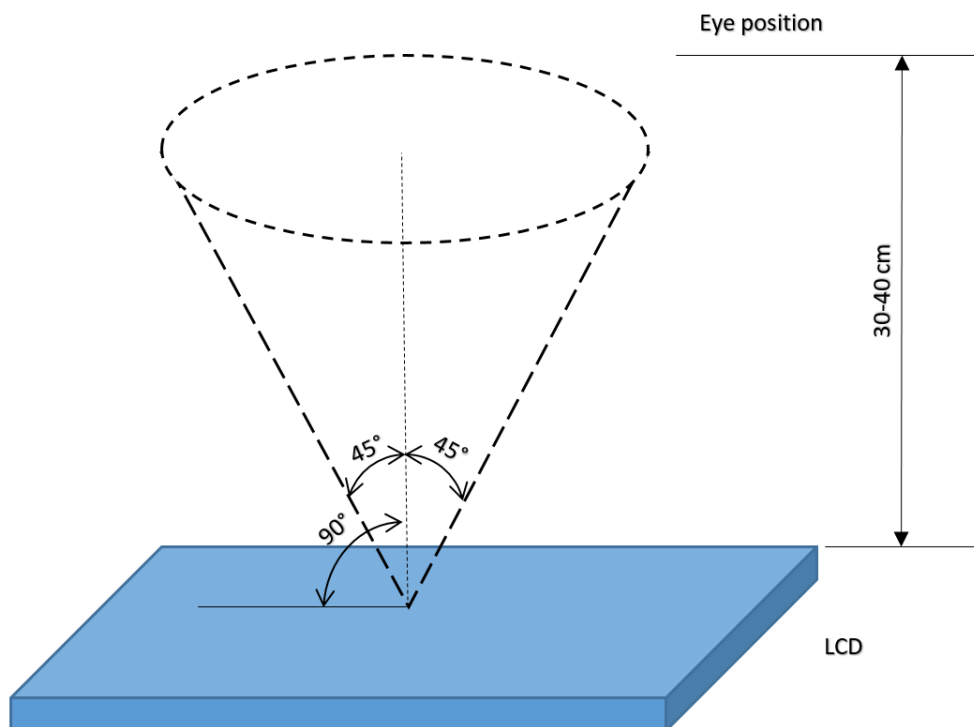

13.2 Inspection standard

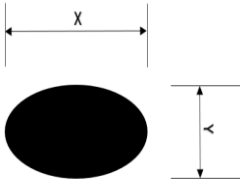
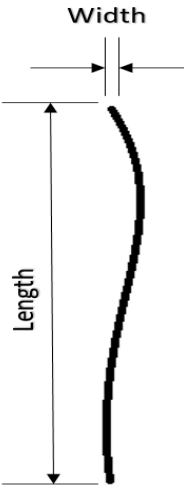
Item	Criterion																																		
<p>Black spots, white spots, light leakage, Foreign Particle (round Type)</p>	<div style="display: flex; align-items: center; justify-content: center;">  <table border="1" style="margin-left: 20px;"> <thead> <tr> <th colspan="2" style="background-color: #cccccc;">Size < 5"</th> </tr> <tr> <th>Average Diameter</th> <th>Qualified Qty</th> </tr> </thead> <tbody> <tr> <td>D < 0.2 mm</td> <td>Ignored</td> </tr> <tr> <td>0.2 mm < D < 0.3 mm</td> <td>3</td> </tr> <tr> <td>0.3 mm < D < 0.5 mm</td> <td>2</td> </tr> <tr> <td>0.5 mm < D</td> <td>0</td> </tr> </tbody> </table> </div> <div style="text-align: center; margin: 10px 0;"> $D = \frac{(x + y)}{2}$ </div> <p>*Spots density: 10 mm</p>	Size < 5"		Average Diameter	Qualified Qty	D < 0.2 mm	Ignored	0.2 mm < D < 0.3 mm	3	0.3 mm < D < 0.5 mm	2	0.5 mm < D	0																						
Size < 5"																																			
Average Diameter	Qualified Qty																																		
D < 0.2 mm	Ignored																																		
0.2 mm < D < 0.3 mm	3																																		
0.3 mm < D < 0.5 mm	2																																		
0.5 mm < D	0																																		
<p>LCD black spots, white spots, light leakage (line Type)</p>	<div style="display: flex; align-items: center; justify-content: center;">  <table border="1" style="margin-left: 20px;"> <thead> <tr> <th colspan="3" style="background-color: #cccccc;">Size < 5"</th> </tr> <tr> <th>Length</th> <th>Width</th> <th>Qualified Qty</th> </tr> </thead> <tbody> <tr> <td>-</td> <td>W < 0.02</td> <td>Ignored</td> </tr> <tr> <td>L < 3.0</td> <td>0.02 < W < 0.05</td> <td rowspan="2">2</td> </tr> <tr> <td>L < 2.5</td> <td>0.05 < W < 0.08</td> </tr> <tr> <td>-</td> <td>0.08 < W</td> <td>0</td> </tr> </tbody> </table> </div> <div style="margin: 10px 0;"> <table border="1" style="width: 100%;"> <thead> <tr> <th colspan="3" style="background-color: #cccccc;">Size >= 5"</th> </tr> <tr> <th>Length</th> <th>Width</th> <th>Qualified Qty</th> </tr> </thead> <tbody> <tr> <td>-</td> <td>W < 0.02</td> <td>Ignored</td> </tr> <tr> <td>L < 3.0</td> <td>0.02 < W < 0.05</td> <td rowspan="2">4</td> </tr> <tr> <td>L < 2.5</td> <td>0.05 < W < 0.08</td> </tr> <tr> <td>-</td> <td>0.08 < W</td> <td>0</td> </tr> </tbody> </table> </div> <p>*Spots density: 10 mm</p>	Size < 5"			Length	Width	Qualified Qty	-	W < 0.02	Ignored	L < 3.0	0.02 < W < 0.05	2	L < 2.5	0.05 < W < 0.08	-	0.08 < W	0	Size >= 5"			Length	Width	Qualified Qty	-	W < 0.02	Ignored	L < 3.0	0.02 < W < 0.05	4	L < 2.5	0.05 < W < 0.08	-	0.08 < W	0
Size < 5"																																			
Length	Width	Qualified Qty																																	
-	W < 0.02	Ignored																																	
L < 3.0	0.02 < W < 0.05	2																																	
L < 2.5	0.05 < W < 0.08																																		
-	0.08 < W	0																																	
Size >= 5"																																			
Length	Width	Qualified Qty																																	
-	W < 0.02	Ignored																																	
L < 3.0	0.02 < W < 0.05	4																																	
L < 2.5	0.05 < W < 0.08																																		
-	0.08 < W	0																																	

Item	Criterion	
Clear spots	Size < 5"	
	Average Diameter	Qualified Qty
	D < 0.2 mm	Ignored
	0.2 mm < D < 0.3 mm	3
	0.3 mm < D < 0.5 mm	2
	0.5 mm < D	0
	Size >= 5"	
	Average Diameter	Qualified Qty
	D<0.2 mm	Ignored
	0.2 mm < D < 0.3 mm	4
	0.3 mm < D < 0.5 mm	2
	0.5 mm < D	0
	*Spots density: 10 mm	
	Polarizer bubbles	Size < 5"
Average Diameter		Qualified Qty
D < 0.2 mm		Ignored
0.2 mm < D < 0.5 mm		3
0.5 mm < D < 1 mm		2
1 mm < D		0
Total Q'ty		3
Size >= 5"		
Average Diameter		Qualified Qty
D<0.25 mm		Ignored
0.25 mm < D < 0.5 mm		3
0.5 mm < D		0
Electrical Dot Defect		Size < 5"
		item
	Black do defect	4
	Bright dot defect	2
	Total Dot	5
	Size >= 5"	
	item	Qualified Qty
	Black do defect	5
	Bright dot defect	2
	Total Dot	5

Item	Criterion			
Touch panel spot	Size < 5"			
	Average Diameter	Qualified Qty		
	D < 0.2 mm	Ignored		
	0.2 mm < D < 0.4 mm	5		
	0.4 mm < D < 0.5 mm	2		
	0.5 mm < D	0		
	Size >= 5"			
	Average Diameter	Qualified Qty		
	D<0.25 mm	Ignored		
	0.25 mm < D < 0.5 mm	4		
	0.5 mm < D	0		
	Touch panel White Line Scratch	Size < 5"		
		Length	Width	Qualified Qty
		-	W< 0.02	Ignored
L < 3.0		0.02 < W <0.05	2	
L < 2.5		0.05 < W <0.08		
-		0.08 < W	0	
Size >= 5"				
Length		Width	Qualified Qty	
-		W< 0.03	Ignored	
L < 5.0		0.03 < W <0.05	2	
-		0.05 < W	0	

14 RELIABILITY TEST

NO.	TEST ITEM	TEST CONDITION
1	High Temperature Storage	80±2°C/240hours
2	Low Temperature Storage	-30±2°C/240hours
3	High Temperature Operating	70±2°C/240hours
4	Low Temperature Operating	-20±2°C/240hours
5	Temperature Cycle	-30±2°C~25~80±2°C × 20 cycles (30min.) (5min.) (30min.)
6	Damp Proof Test	60°C ±5°C × 90%RH/240hours
7	Vibration Test	Frequency 10Hz~55Hz Amplitude of vibration: 1.5mm Sweep: 10Hz~55Hz~10Hz X, Y, Z 2 hours for each direction.
8	Package Drop Test	Height:60 cm 1 corner, 3 edges, 6 surfaces
9	ESD Test	Air: ±4KV 150pF/330Ω 5 times Contact: ±2KV 150pF/330Ω 5 time

15 INFORMATION

Riverdi makes no warranty, either expressed or implied with respect to any product, and specifically disclaims all other warranties, including, without limitation, warranties for merchantability, non-infringement and fitness for any particular purpose. Information about device are the property of Riverdi and may be the subject of patents pending or granted. It is not allowed to copy or disclosed this document without prior written permission.

Riverdi endeavors to ensure that the all contained information in this document are correct but does not accept liability for any error or omission. Riverdi products are in developing process and published information may be not up to date. Riverdi reserves the right to update and makes changes to Specifications or written material without prior notice at any time. It is important to check the current position with Riverdi.

Images and graphics used in this document are only for illustrative the purpose. All images and graphics are possible to be displayed on the range products of Riverdi, however the quality may vary. Riverdi is no liable to the buyer or to any third part for any indirect, incidental, special, consequential, punitive or exemplary damages (including without limitation lost profits, lost savings, or loss of business opportunity) relating to any product, service provided or to be provided by Riverdi, or the use or inability to use the same, even if Riverdi has been advised of the possibility of such damages.

Riverdi products are not fault tolerant nor designed, manufactured or intended for use or resale as on line control equipment in hazardous environments requiring fail – safe performance, such as in the operation of nuclear facilities, aircraft navigation or communication systems, air traffic control, direct life support machines or weapons systems in which the failure of the product could lead directly to death, personal injury or severe physical or environmental damage ('High Risk Activities'). Riverdi and its suppliers specifically disclaim any expressed or implied warranty of fitness for High Risk Activities. Using Riverdi products and devices in 'High Risk Activities' and in any other application is entirely at the buyer's risk, and the buyer agrees to defend, indemnify and hold harmless Riverdi from any and all damages, claims or expenses resulting from such use. No licenses are conveyed, implicitly or otherwise, under any Riverdi intellectual property rights.

