

Specifications for LCD module

Customer	
Customer part no.	
Ampire part no.	AM-1024600DTZQW-TH0H
Approved by	
Date	

- Preliminary Specification**
 Approved Specification

Approved by	Checked by	Organized by

RECORD OF REVISION

Revision Date	Page	Contents	Editor
2017/10/06	-	New release	Simon

Intelligent Display Solutions, Unit 2, Berkshire Business Centre, Berkshire Drive, Thatcham, Berkshire, RG19 4EW
Telephone : +44 (0)1635 294600 Fax : +44 (0)1635 869200 Email: info@i-lcd.com
www.i-lcd.com A division of Intelligent Group Solutions Ltd

1. Features

It's a 7 inches Amorphous-TFT-LCD (Thin Film Transistor Liquid Crystal Display) module. This module is composed of a 7" TFT-LCD panel, LED backlight.

1. 7" TFT Liquid Crystal Display module
 - Construction: 7" a-Si TFT active matrix, White LED Backlight.
 - Resolution (pixel): 1024 RGB (H) x 600 (V)
 - Number of the Colors : 16.7M colors (R , G , B 8 bit digital each)
 - LCD type : Normally Black
2. HDMI to LCD interface board
 - Single Power input: 12V / 2A power input. (Connector: PJ2).
 - HDMI Digital input : (Connector: HDMI1)
 - ◆ HDMI 1.4a Compliant
 - ◆ Single-link (Type A HDMI) on-chip TMDS receiver up to 225MHz.
Support long cable.
 - ◆ Do not support HDCP.
 - Support input video format :

2. PHYSICAL SPECIFICATIONS

Item	Specifications	unit
LCD size	7 inch (Diagonal)	
Resolution	1024 x (RGB) x 600	dot
Pixel pitch	0.1506(W) x 0.1432(H)	mm
Active area	154.2144(W) x 85.92(H)	mm
Module size	184.0(W) x 128.0(H) x 23.75 (D)	mm
Color arrangement	RGB-stripe	

3. ABSOLUTE MAX. RATINGS

ITEM	SYMBOL	VALUES		UNIT	REMARK
		MIN	MAX		
Power Voltage	V _{IN}	-0.3	13	V	GND=0V, TA=25°C
Operation Temperature	T _{op}	-20	70	°C	
Storage Temperature	T _{st}	-30	80	°C	

Note 1: The absolute maximum rating values of this product are not allowed to be exceeded at any times. Should a module be used with any of the absolute maximum ratings exceeded, the characteristics of the module may not be recovered, or in an extreme case, the module may be permanently destroyed.

4. ELECTRICAL SPECIFICATIONS

4.1 Typical Operation Conditions (HDMI Interface Board)

Item	Symbol	Min	Typ	Max	Unit	Note
HDMI Interface Board Power Supply voltage	V_{IN}	11.5	12.0	12.5	V	
Power Consumption	I_{VIN}		T.B.D	1A		

4.2 Typical Operation Conditions (TFT LCD Module)

For Design reference only. These supply voltage and signals do not need to input by end user.

Item	Symbol	Min.	Typ.	Max.	Unit	Condition
Digital Power Supply Voltage	VDD	3.0	3.3	3.6	V	
Digital Power Supply Current	IDD		105		mA	
Differential Input High Threshold	VTH	--	--	100	mV	VCM=1.2V
Differential Input Low Threshold	VTL	-100	--	--	mV	
Input current	IIN	-10	--	+10	uA	
Differential input Voltage	VID	0.2	--	0.6	V	
Common Mode Voltage Offset	VCM	$\frac{ VID }{2}$	1.25	$2.4 \cdot \frac{ VID }{2}$	V	

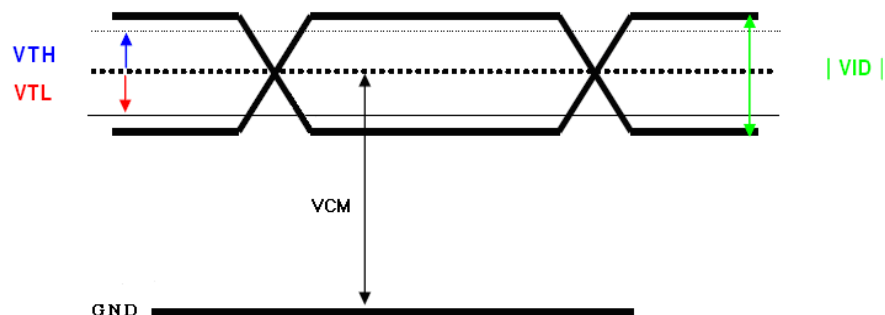

4.2.1 24-BIT LVDS Input Data Format

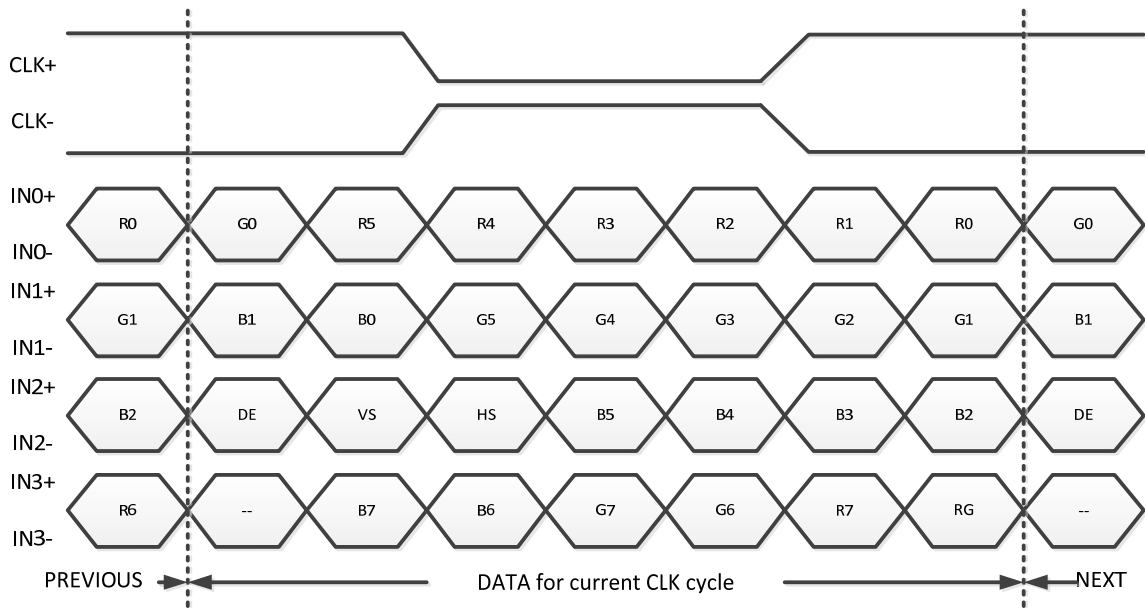

Note: R/G/B data 7: MSB, R/G/B data 0: LSB

Signal Name	Description	Remark
R7 R6 R5 R4 R3 R2 R1 R0	Red Data 7 (MSB) Red Data 6 Red Data 5 Red Data 4 Red Data 3 Red Data 2 Red Data 1 Red Data 0 (LSB)	Red-pixel Data Each red pixel's brightness data consists of these 8 bits pixel data.
G7 G6 G5 G4 G3 G2 G1 G0	Green Date 7 (MSB) Green Date 6 Green Date 5 Green Date 4 Green Date 3 Green Date 2 Green Date 1 Green Date 0 (LSB)	
B7 B6 B5 B4 B3 B2 B1 B0	Blue Data 7 (MSB) Blue Data 6 Blue Data 5 Blue Data 4 Blue Data 3 Blue Data 2 Blue Data 1 Blue Data 0 (LSB)	
CLK+ CLK-	LVDS Clock Input	
DE	Display Enable	
VS	Vertical Sync Signal	
HS	Horizontal Sync Signal	

4.2.2 Timing Table

LCD Interface Timing (DE mode)

Parameter	Symbol	Value			Unit
		Min.	Typ.	Max.	
DCLK frequency @Frame rate=60hz	fclk	40.8	51.2	67.2	Mhz
Horizontal display area	thd	1024			DCLK
HSYNC period time	th	1114	1344	1400	DCLK
HSYNC blanking	thb+thfp	90	320	376	DCLK
Vertical display area	tvd	600			H
VSYNC period time	tv	610	635	800	H
VSYNC blanking	tvb+tvfp	10	35	200	H

4. Backlight Driving Conditions

For Design reference only. These supply voltage and signals do not need to input by end user.

LED Driver Power Voltage	VLED	--	12	19	V	
LED Driver Power Current	ILED(VLED=12V)	--	289	--	mA	Ta=25°C
PWM Dimming DC active level	VDIMH	1.5	--	6	V	
	VDIML	--	--	0.6	V	
PWM Dimming Freq.	FDIM	0.2		20	kHz	
BLEN Pin High Voltage	VBLENH	1.4		--	V	
BLEN Pin Low Voltage	VBLENL	--		0.8	V	
LED voltage	VAK	--	23.1	--	V	Note 1
LED current	IF	--	120	--	mA	Note 1
LED life time	--	--	30	--	kHrs	Note 2

Note (1) The LED Supply Voltage is defined by the number of LED at Ta=25°C and IF=120 mA.

Note (2) The "LED life time" is defined as the module brightness decrease to 50% original brightness at Ta=25°C and IF=120mA. The LED lifetime could be decreased if operating IF is larger than 120mA.

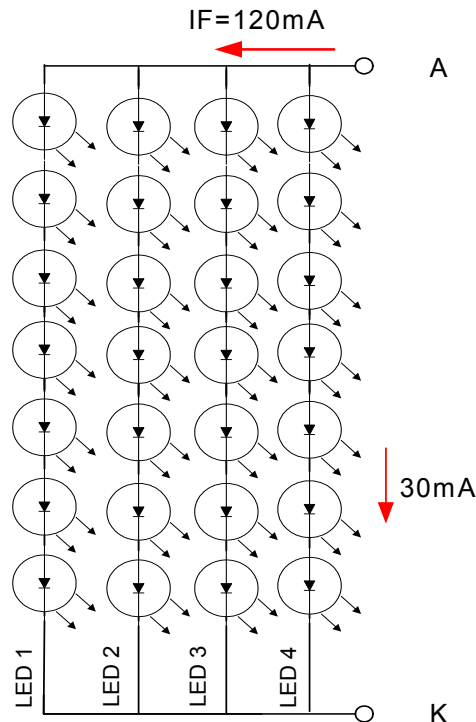

Note (3) When LCM is operated over 40°C ambient temperature, the IF should be follow :

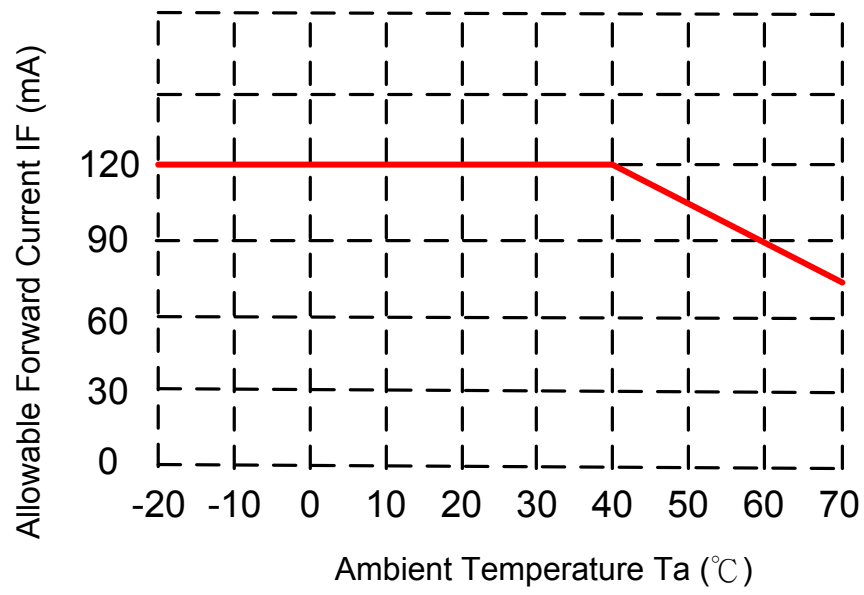

5. INTERFACE

5.1 INTERFACE (HDMI Interface Board)

- **PJ2 Power Supply Power Jack:**

Inner terminal is positive. Outer terminal is GND

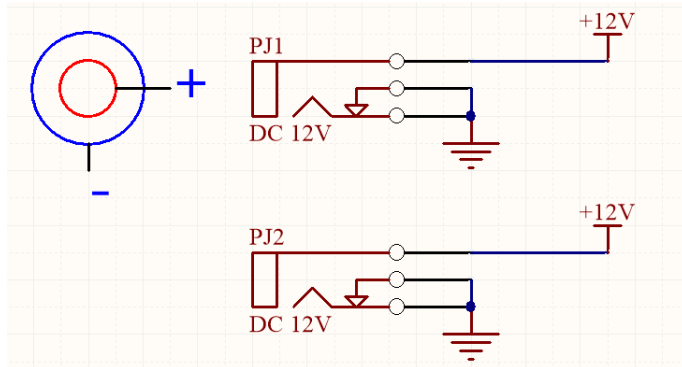

- **HDMI1: HDMI Type A Connector**

HDMI			
PIN	SIGNAL	PIN	SIGNAL
1	TMDS Data2+	11	TMDS Clock Shield (Ground)
2	TMDS Data2 Shield (Ground)	12	TMDS Clock-
3	TMDS Data2-	13	CEC (not used)
4	TMDS Data1+	14	Reserved (No Connection)
5	TMDS Data1 Shield (Ground)	15	SCL
6	TMDS Data1-	16	SDA
7	TMDS Data0+	17	DDC/CED (Ground)
8	TMDS Data0 Shield (Ground)	18	+5V input
9	TMDS Data0-	19	Hot Plug Detect
10	TMDS Clock+		

6. Optical Specifications

Item	Symbol	Condition	Values			Unit	Note
			Min.	Typ.	Max.		
Viewing angle (CR \geq 10)	θ L	$\Phi = 180^\circ$ (9 o'clock)	80	85	--	degree	Note1
	θ R	$\Phi = 0^\circ$ (3 o'clock)	80	85	--		
	θ T	$\Phi = 90^\circ$ (12 o'clock)	80	85	--		
	θ B	$\Phi = 270^\circ$ (6 o'clock)	80	85	--		
Response time	TON	Normal $\theta = \Phi = 0^\circ$	--	13	20	msec	Note3
	TOFF		--	15	25	msec	
Contrast ratio	CR		600	800	--	--	Note4
Color chromaticity	WX		0.26	0.31	0.36	--	Note5 Note6
	WY		0.31	0.36	0.41	--	
	RX		0.56	0.61	0.66		
	RY		0.29	0.34	0.39		
	GX		0.31	0.36	0.41		
	GY		0.52	0.57	0.62		
	BX		0.05	0.10	0.15		
	BY	0.03	0.08	0.13			
Luminance (central point)	L	340	425	--	cd/m ²	Note6	
Luminance uniformity	YU	70	75	--	%	Note6	

Test Conditions:

VDD = 3.3V, IF = 132 mA (Backlight current), the ambient temperature is 25°C.

The test systems refer to Note 2.

Note (1) Definition of viewing angle range

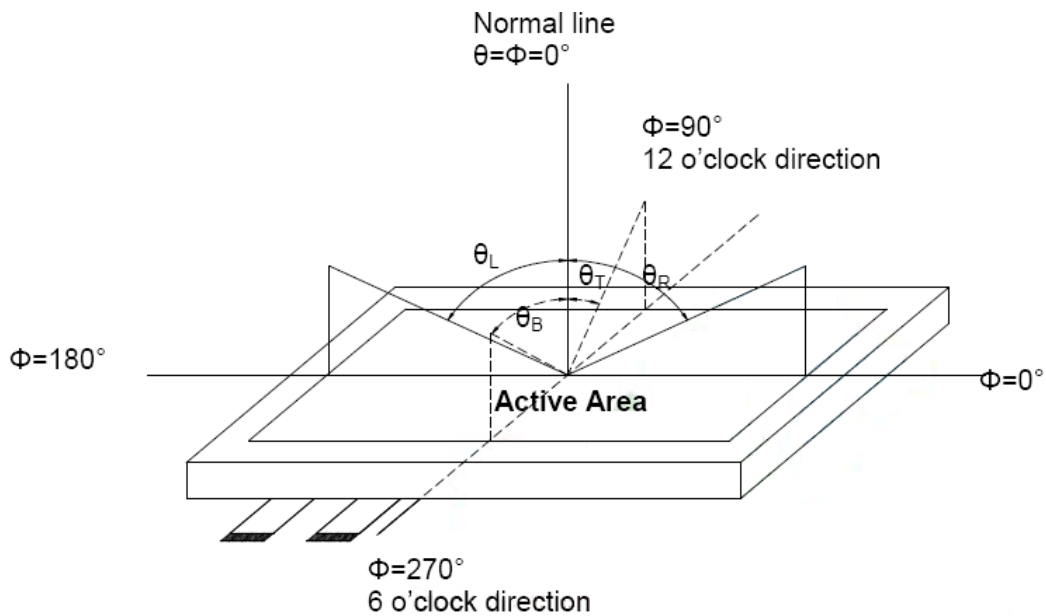

Note (2) Definition of optical measurement system

The optical characteristics should be measured in dark room. After 30 minutes operation, the optical properties are measured at the center point of the LCD screen. (Response time is measured by Photo detector TOPCON BM-7, other items are measured by BM-5A/Field of view: 1° / Height: 500mm.)

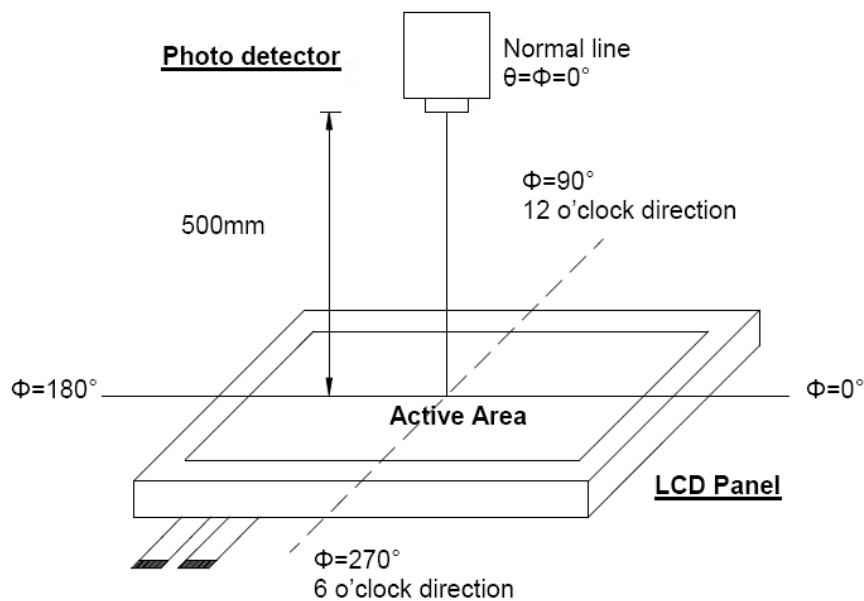

Note (3) Definition of Response time

The response time is defined as the LCD optical switching time interval between “White” state and “Black” state. Rise time (TON) is the time between photo detector output intensity changed from 90% to 10%. And fall time (TOFF) is the time between photo detector output intensity changed from 10% to 90%.

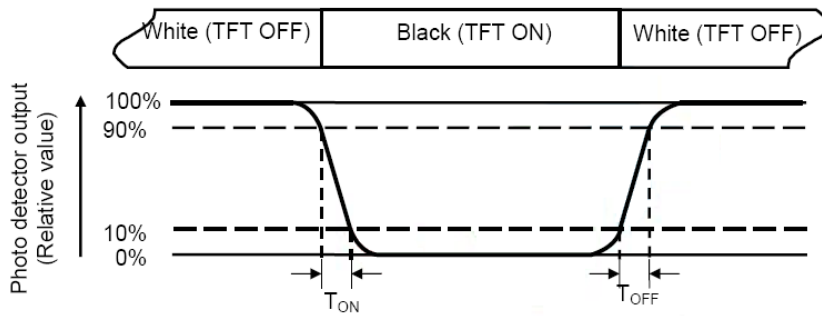

Note (4) Definition of contrast ratio

$$\text{Contrast ratio (CR)} = \frac{\text{Luminance measured when LCD on the "White" state}}{\text{Luminance measured when LCD on the "Black" state}}$$

Note (5) Definition of color chromaticity (CIE1931)

Color coordinated measured at center point of LCD.

All input terminals LCD panel must be ground when measuring the center area of the panel.

Note (6) Definition of Luminance Uniformity

Active area is divided into 9 measuring areas (Refer to bellow figure).

Every measuring point is placed at the center of each measuring area.

$$\text{Luminance Uniformity (Yu)} = \frac{B_{\min}}{B_{\max}}$$

L ----- Active area length W ----- Active area width

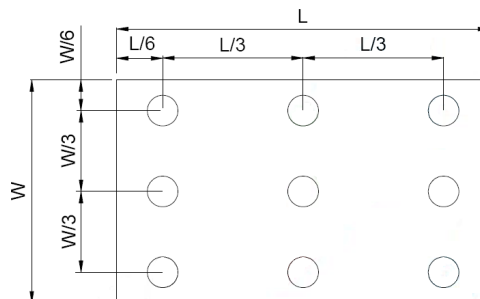

Bmax : The measured maximum luminance of all measurement position.

Bmin : The measured minimum luminance of all measurement position.

Note (7) Pixel format

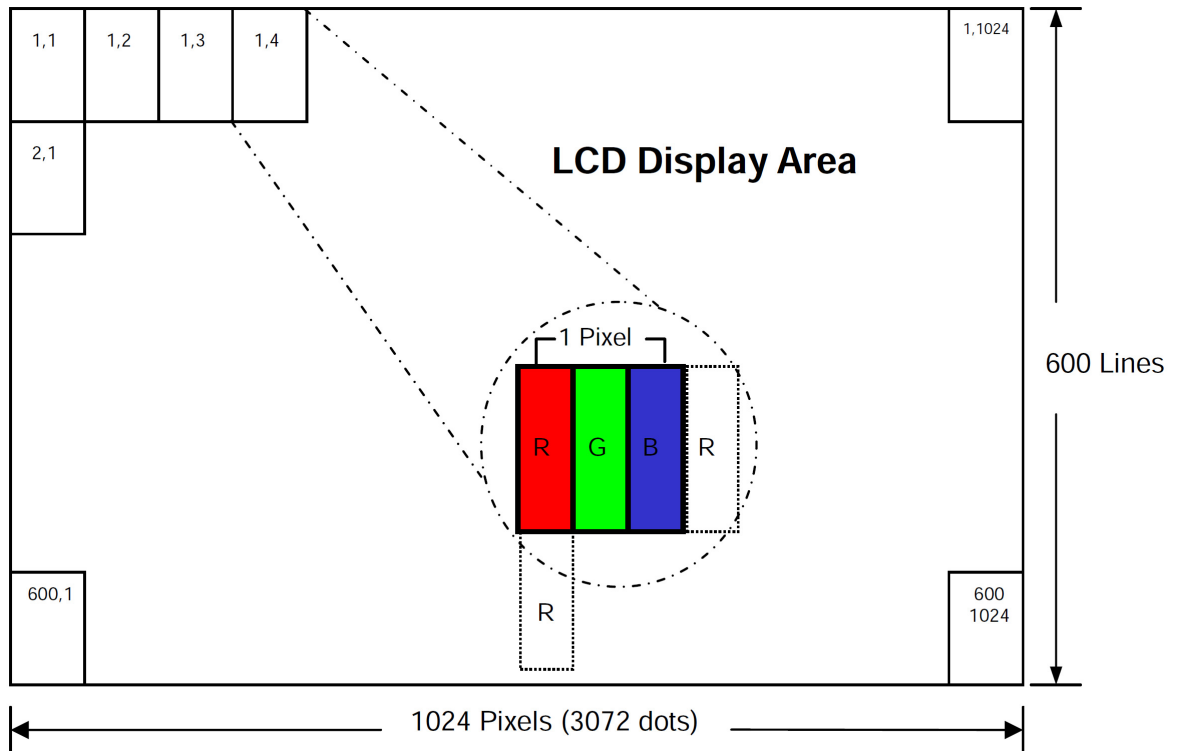

7. Projected capacitive-type TOUCH PANEL ELECTRICAL SPECIFICATION

ITEM	SPECIFICATION
Type	Projective Capacitive Touch Panel
Activation	Two-fingers or Single-finger
X/Y Position Reporting	Absolute Position
Touch Force	No contact pressure required
Calibration	No need for calibration
Report Rate	Approx 100 points/sec
Interface	USB
Control IC	EETI3132

ITEM	Symbol	MIN	TYP	MAX	UNIT
Touch panel power supply	V _{IN}	4.75	5	5.25	V
Touch panel power supply current at Normal operation mode	I _{VIN}	--	45(Reference)	--	mA
Touch panel power supply current at USB suspend mode	I _{VIN}	--	TBD	--	μA

Interface

Pin No.	Symbol	Function
1	GND	GND
2	DA-	USB Data-
3	DA+	USB Data+
4	VIN	USB POWER 5V
5	NA	No connection
6	NA	No connection

8. RELIABILITY TEST CONDITIONS

Test Item	Test Conditions	Note
High Temperature Operation	70±3°C , t=240 hrs	
Low Temperature Operation	-20±3°C , t=240 hrs	
High Temperature Storage	80±3°C , t=240 hrs	1,2
Low Temperature Storage	-30±3°C , t=240 hrs	1,2
Storage at High Temperature and Humidity	60°C, 90% RH , 240 hrs	1,2

Note (1) Condensation of water is not permitted on the module.

Note (2) The module should be inspected after 1 hour storage in normal conditions (15-35°C, 45-65%RH).

9. General Precautions

9.1 Safety

- (1) Liquid crystal is poisonous. Do not put it your month. If the liquid crystal touches you skin or clothes, you need to wash it off immediately with the soap and water.

9.2 Handling

- (1) The LCD panel is plate glass. Do not subject the panel to mechanical shock or excessive force on its surface.
- (2) The polarizer which attached to the display is easily damaged. Please handle it carefully to avoid scratch or other damages.
- (3) To avoid contamination on the display surface, do not touch the module surface with bare hands.
- (4) Keep a space so that the LCD panels do not touch other components.
- (5) Put on cover board such as acrylic board, which covers on the surface of LCD panel to protect panel from damages.
- (6) Transparent electrodes may be disconnected if you use the LCD panel under environmental conditions where the condensation of dew occurs.
- (7) Do not leave module in direct sunlight to avoid malfunction of the ICs.

9.3 Mechanism

- (1) Please mount LCD module by using mounting holes arranged in four corners tightly.
- (2) The square adhesive tape which is between the touch panel and display can't provide well supporting in the long term and high ambient temperature condition. Whether upright or horizontal position the support holder which is in the back side of the display is needed. Do not let the display floating.

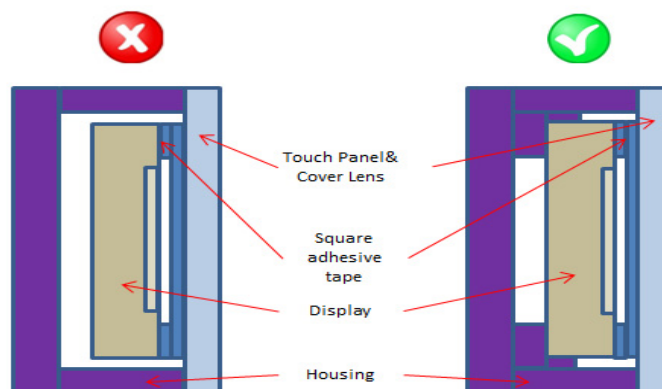
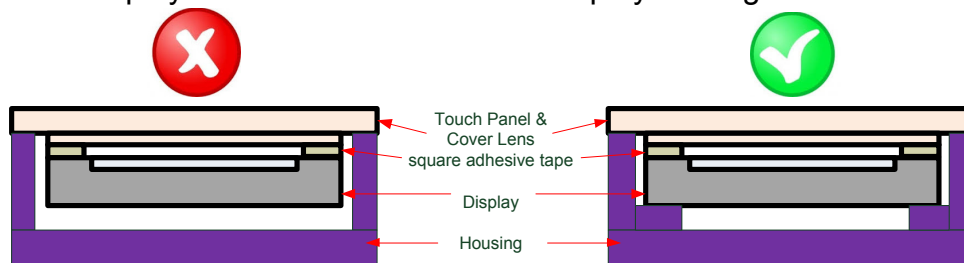

9.4 Static Electricity

- (1) Be sure to ground module before you turn on power or operation module.
- (2) Do not apply voltage which exceeds the absolute maximum rating value.

9.5 Storage

- (1) Store the module in a dark room where it must keep at $+25\pm 10^{\circ}\text{C}$ and 65%RH or less.
- (2) Do not store the module in surroundings which are containing organic solvent or corrosive gas.
- (3) Store the module in an anti-electrostatic container or bag.

9.6 Cleaning

- (1) Do not wipe the polarizer with dry cloth. It might cause scratch.
- (2) Only use a soft sloth with IPA to wipe the polarizer, other chemicals might permanent damage to the polarizer.

9.7 Others

- (1) AMIPRE will provide one year warrantee for all products and three months warrantee for all repairing products.
- (2) Do not apply fixed pattern data signal to the LCD module as you are using the product.

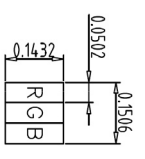

A Block

HDMI

1	Data2+
2	Data2 Shield (Ground)
3	Data2-
4	Data1+
5	Data1 Shield (Ground)
6	Data1-
7	Data0+
8	Data0 Shield (Ground)
9	Data0-
10	Clock+
11	Clock Shield (Ground)
12	Clock-
13	CEC (not used)
14	Reserver (no connection)
15	Data1 Shield (Ground)
16	SCL
17	SDA
18	+5V input
19	Hot Plug Detect

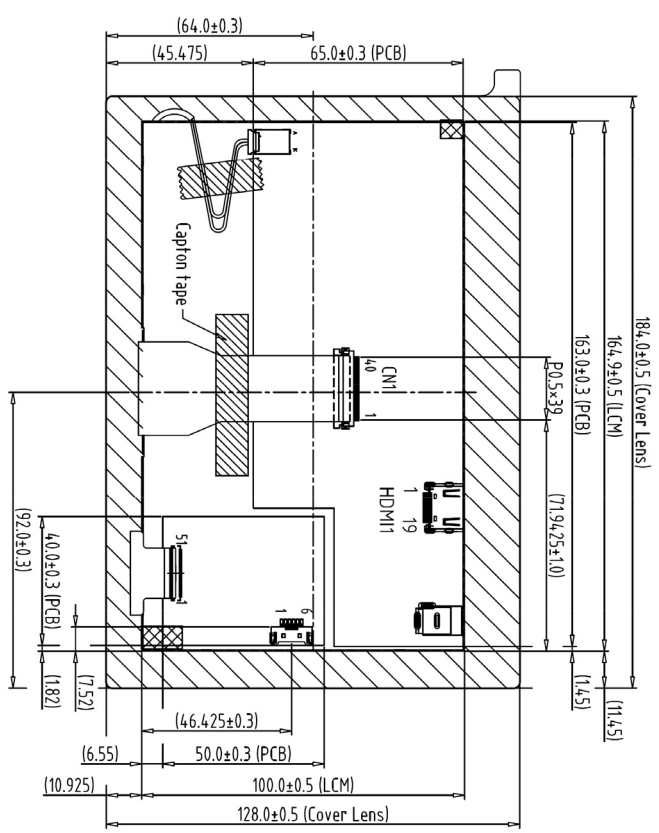

Back View

Note:

1. Unless indicated, Tolerance "±0.3"
2. UV Glue For OLB Protection.
3. HDMI A TYPE: P0.5 19Pin/HDFP1L-1N51 or Equivalent
4. CN1: P0.5 40PIN H2.0/089H40-000000-G2-R or Equivalent.
5. DC Jack: DC-0005-20-20Z2S-Y or Equivalent.
6. T/P Controller board: ENTERY 3808K-F06N-03L or Equivalent
7. LCD 1024X3(R,G,B)x600 => 7.0" Digital TFT LCD

USB interface:

1	GND
2	DA-
3	DA+
4	VIN
5	NA
6	NA

1	1024600D-TA0 LCM	7		TOLERANCE GRAD(F)	A	B	DIM. MM	DWN. EMILY	DATE 10-02-17	TITLE 1024600D-TH0
2	New PCB (HDMI/4Layers)	8								DWG. NO. *171002MA
3		9						CHEK.	DATE	SHEET 1 OF 1
4		10								
5		11								
6		12								