



Connectors > Power Connectors > Circular Power > Circular Power Connectors



Connector Product Type: **Housing**

Operating Voltage: **600 VDC**

Connector System: **Wire-to-Wire**

Number of Positions: **37**

Sealable: **No**

Features

Product Type Features

Connector Product Type	Housing
Connector System	Wire-to-Wire
Sealable	No
Connector & Contact Terminates To	Wire & Cable
Connector & Housing Type	Receptacle
Circular Connector Shell Type	All Plastic

Configuration Features

Reverse Numbering	Without
Number of Positions	37
Number of Power Positions	0
Keying	A
Number of Signal Positions	37

Electrical Characteristics

Operating Voltage	600 VAC
-------------------	---------



Contact Features

Reverse Gender	Yes
Contact Type	Socket
Contact Protection	With

Mechanical Attachment

Panel Mount Feature Type	Flange with Threaded Inserts
Screw & Hole Thread Size	1-3/8 - 18 UNEF-2A
Connector Mounting Type	Panel Mount
Mating Alignment	With
Mating Retention	With
Panel Mount Feature	With
Mating Alignment Type	Keyed
Mating Retention Type	Threaded Coupling

Housing Features

Body Orientation	Straight
Housing Color	Black
Housing Material	Nylon - GF
Circular Connector Shell Size	23

Usage Conditions

Operating Temperature Range	-55 – 105 °C[-67 – 221 °F]
Fluid Resistance	None

Operation/Application

Circuit Application	Power & Signal
Shielded	No

Industry Standards

UL Flammability Rating	UL 94V-0
VDE Tested	No

Packaging Features

Packaging Method	Standard
Packaging Quantity	100

Other

Comment	5 Locating Key Arrangement.
---------	-----------------------------



Product Compliance

[For compliance documentation, visit the product page on TE.com>](#)

EU RoHS Directive 2011/65/EU	Compliant with Exemptions
EU ELV Directive 2000/53/EC	Compliant with Exemptions
China RoHS 2 Directive MIIT Order No 32, 2016	Restricted Materials Above Threshold
EU REACH Regulation (EC) No. 1907/2006	<p>Current ECHA Candidate List: JUNE 2022 (224)</p> <p>Candidate List Declared Against: JUNE 2022 (224)</p> <p>SVHC > Threshold:</p> <p>Pb (3.7% in Component Part)</p> <p>Article Safe Usage Statements: Do not eat, drink or smoke when using this product. Wash thoroughly after handling. Recycle if possible and dispose of the article by following all applicable governmental regulations relevant to your geographic location.</p>
Halogen Content	BFR/CFR/PVC Free, but Br/Cl >900 ppm in other sources.
Solder Process Capability	Not applicable for solder process capability

Product Compliance Disclaimer

This information is provided based on reasonable inquiry of our suppliers and represents our current actual knowledge based on the information they provided. This information is subject to change. The part numbers that TE has identified as EU RoHS compliant have a maximum concentration of 0.1% by weight in homogenous materials for lead, hexavalent chromium, mercury, PBB, PBDE, DBP, BBP, DEHP, DIBP, and 0.01% for cadmium, or qualify for an exemption to these limits as defined in the Annexes of Directive 2011/65/EU (RoHS2). Finished electrical and electronic equipment products will be CE marked as required by Directive 2011/65/EU. Components may not be CE marked. Additionally, the part numbers that TE has identified as EU ELV compliant have a maximum concentration of 0.1% by weight in homogenous materials for lead, hexavalent chromium, and mercury, and 0.01% for cadmium, or qualify for an exemption to these limits as defined in the Annexes of Directive 2000/53/EC (ELV). Regarding the REACH Regulation, the information TE provides on SVHC in articles for this part number is based on the latest European Chemicals Agency (ECHA) 'Guidance on requirements for substances in articles' posted at this URL: <https://echa.europa.eu/guidance-documents/guidance-on-reach>

Compatible Parts

 <p>TE Part # 206305-1 CPC PLUG ASSEMBLY SIZE 23-37</p>	 <p>TE Part # 207299-4 FLANGE PLUG</p>	 <p>TE Part # CAT-AM71-C83998B CPC Cable Clamps</p>	 <p>TE Part # 206305-4 CPC PLUG ASSEMBLY SIZE 23-37</p>
--	--	--	--



Also in the Series | AMP CPC

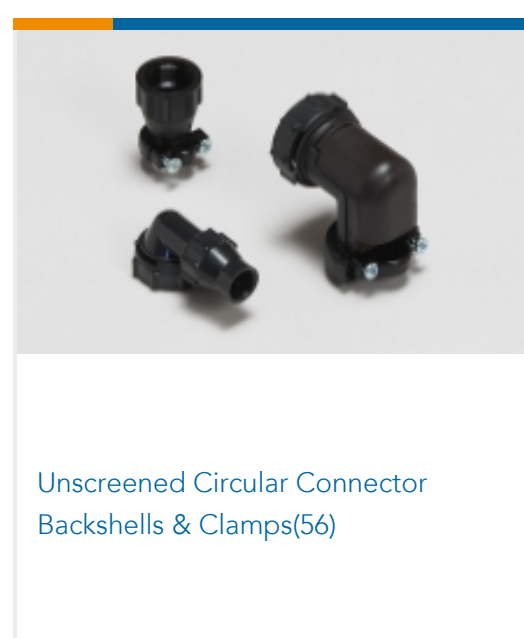
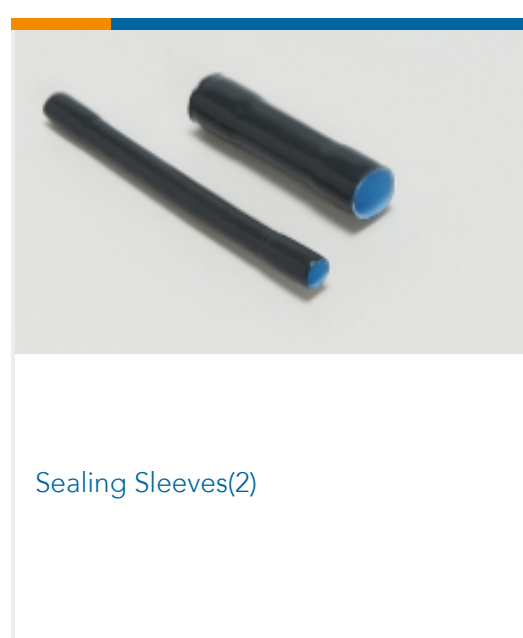
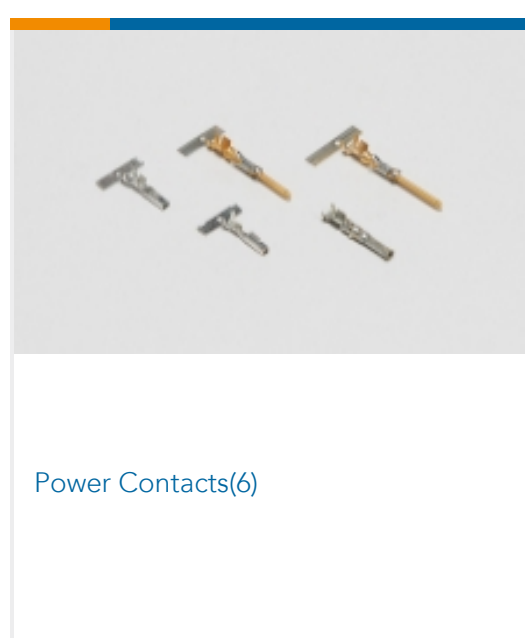
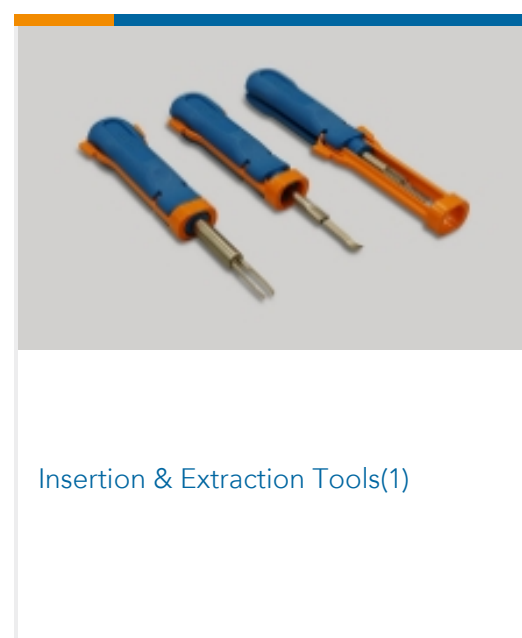
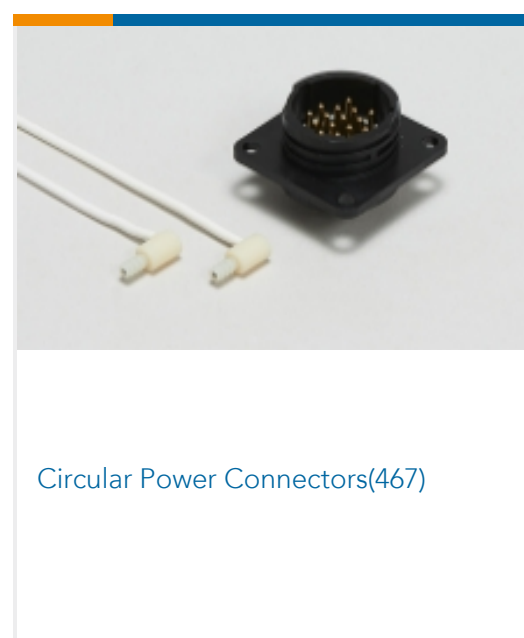
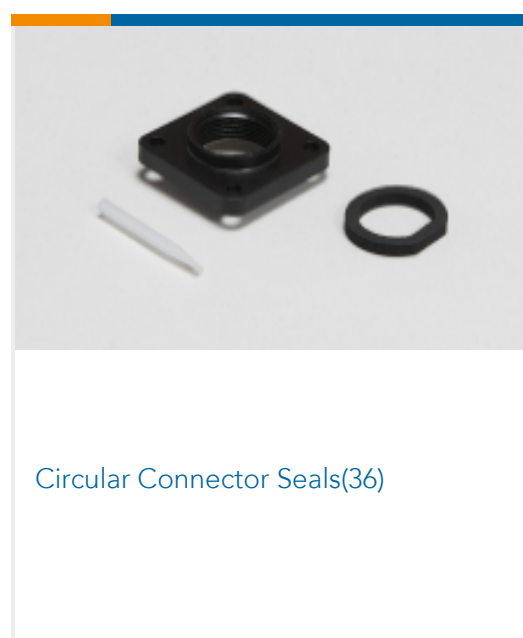
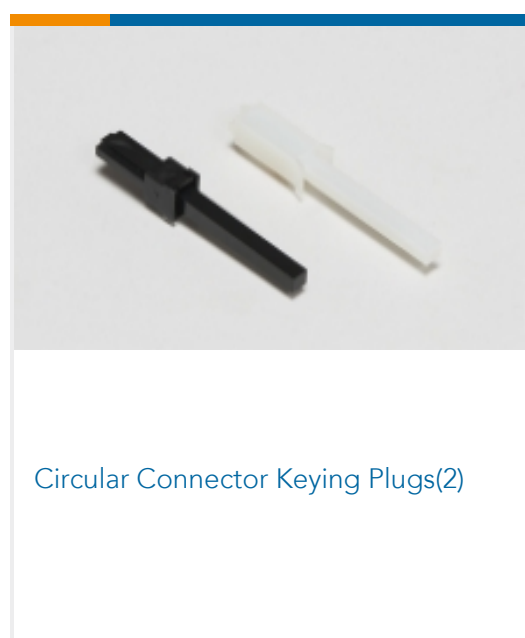
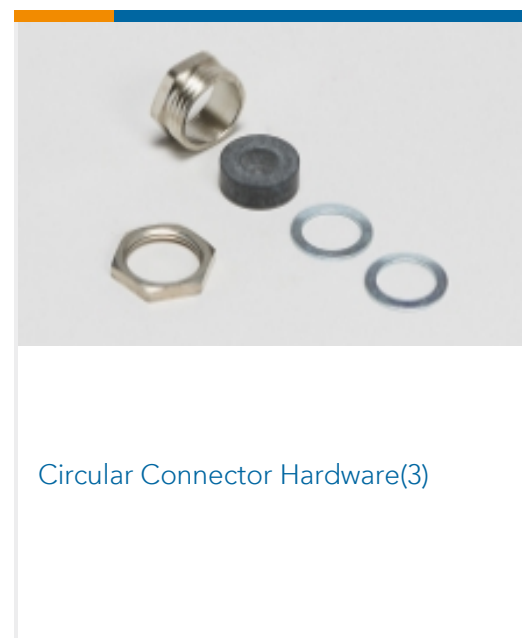
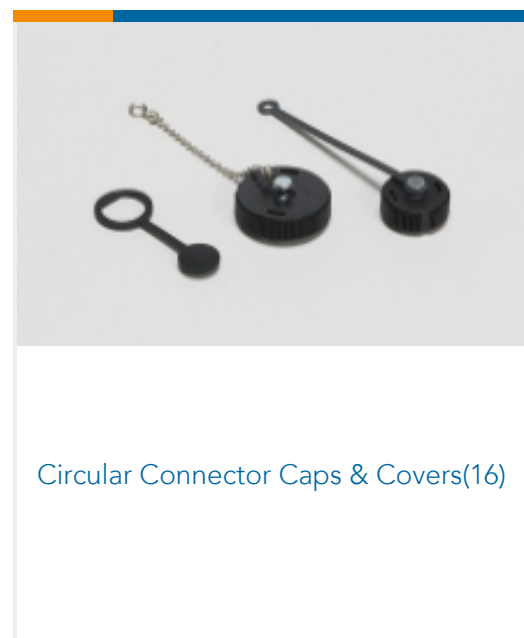
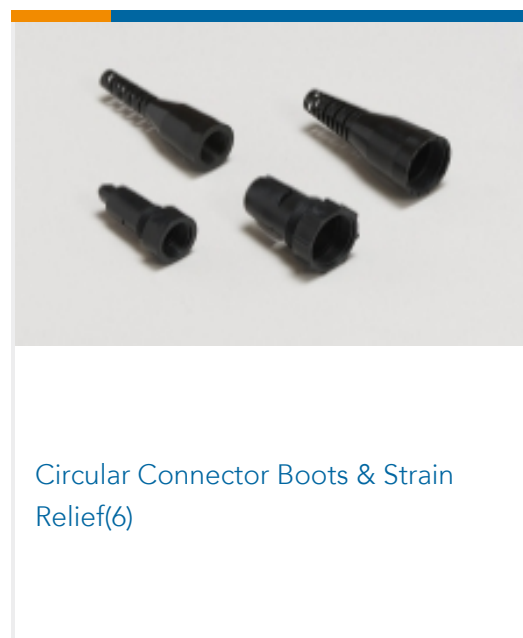
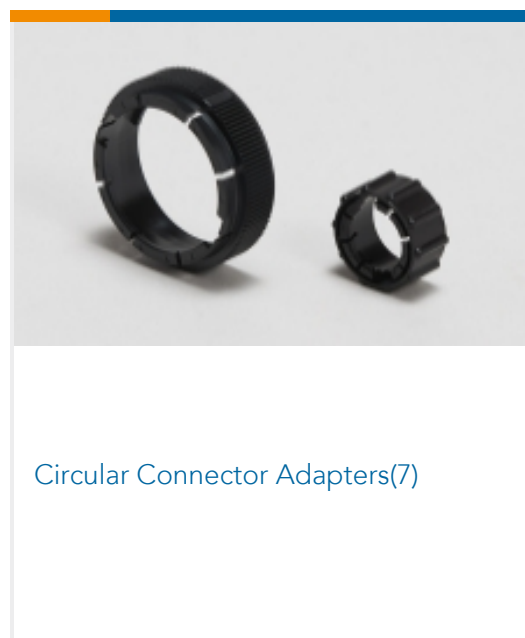

Customers Also Bought

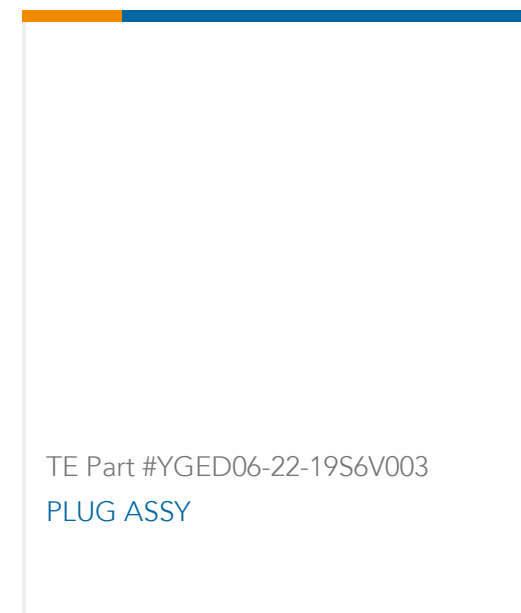
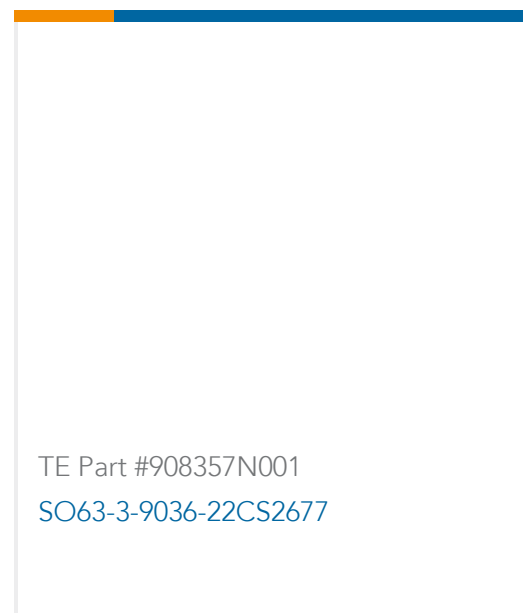
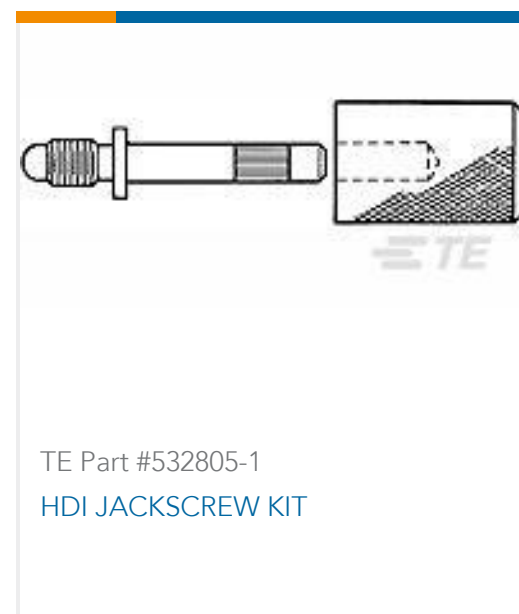

Documents

Product Drawings

[CPC RECEPT ASSEMBLY SIZE 23-37](#)

English

CAD Files

[3D PDF](#)

3D

Customer View Model

[ENG_CVM_CVM_206306-5_AL.2d_dxf.zip](#)

English

Customer View Model

[ENG_CVM_CVM_206306-5_AL.3d_igs.zip](#)

English

Customer View Model

[ENG_CVM_CVM_206306-5_AL.3d_stp.zip](#)

English

By downloading the CAD file I accept and agree to the [Terms and Conditions](#) of use.

Datasheets & Catalog Pages



AMP Circular Connectors for Commercial Signal & Power Applications

English

Product Specifications

Application Specification

English

Product Environmental Compliance

Product Compliance

English

Product Compliance

English

Agency Approvals

UL Report

English