



<b>Title</b>	<b><i>Reference Design Report for 1.44 W Non-Isolated Buck Converter Using 900 V LinkSwitch™-TN2 LNK3294G/P</i></b>
<b>Specification</b>	85 VAC – 440 VAC Input; 12 V, 120 mA Output
<b>Application</b>	Small Appliance / Metering Application
<b>Author</b>	Applications Engineering Department
<b>Document Number</b>	RDR-737
<b>Date</b>	June 9, 2020
<b>Revision</b>	1.1

#### **Summary and Features**

- 900 V maximum drain voltage
- Highly integrated solution
- Lowest possible component count
- No optocoupler required for regulation
- Thermal overload protection with automatic recovery
- <30 mW no-load consumption
- >73% efficiency at full load
- <±5% load regulation

#### **PATENT INFORMATION**

The products and applications illustrated herein (including transformer construction and circuits external to the products) may be covered by one or more U.S. and foreign patents, or potentially by pending U.S. and foreign patent applications assigned to Power Integrations. A complete list of Power Integrations' patents may be found at [www.power.com](http://www.power.com). Power Integrations grants its customers a license under certain patent rights as set forth at <https://www.power.com/company/intellectual-property-licensing/>.

---

#### **Power Integrations**

5245 Hellyer Avenue, San Jose, CA 95138 USA.  
Tel: +1 408 414 9200 Fax: +1 408 414 9201  
[www.power.com](http://www.power.com)

## Table of Contents

1	Introduction .....	4
2	Power Supply Specification .....	5
3	Schematic .....	6
4	Circuit Description .....	7
4.1	Input EMI Filtering .....	7
4.2	900 V LinkSwitch-TN2 .....	7
4.3	Output Rectification .....	8
4.4	Output Feedback .....	8
4.5	Optional Components .....	8
5	Bill of Materials .....	10
6	Design Spreadsheet .....	11
7	Performance Data .....	13
7.1	Efficiency vs. Line .....	13
7.2	Efficiency vs. Load .....	14
7.3	Average Efficiency .....	15
7.3.1	85 VAC / 60 Hz .....	15
7.3.2	115 VAC / 60 Hz .....	15
7.3.3	230 VAC / 50 Hz .....	15
7.3.4	265 VAC / 50 Hz .....	15
7.3.5	440 VAC / 50 Hz .....	15
7.4	Standby Mode Efficiency .....	16
7.4.1	0.2 W Input Power .....	17
7.4.2	0.3 W Input Power .....	17
7.4.3	0.5 W Input Power .....	17
7.4.4	1.0 W Input Power .....	17
7.5	No-Load Input Power .....	18
7.6	Load Regulation .....	19
7.7	Line Regulation at Full Load .....	20
8	Open Case Thermal Performance .....	21
9	Waveforms .....	22
9.1	Switching Waveforms .....	22
9.1.1	LNK3294P Waveforms .....	22
9.1.2	LNK3294P Drain Voltage and Current Waveforms During Start-Up .....	23
9.1.3	Drain Current and Output Waveform During Output Short .....	23
9.1.4	Freewheeling Diode Waveforms .....	24
9.1.5	Output Voltage and Current Waveforms During Start-Up (CC mode) .....	25
9.2	Output Ripple Measurements .....	26
9.2.1	Ripple Measurement Technique .....	26
9.2.2	Measurement Results .....	27
9.2.3	Ripple Voltage Waveforms .....	28
9.2.4	Ripple Voltage Waveforms Using 100 $\mu$ F Output Capacitor .....	29
10	Conductive EMI .....	30
10.1	120 mA Resistive Load, Floating Output (QPK / AV) .....	30



---

10.1.1	Line, 230 VAC.....	30
10.1.2	Line, 115 VAC.....	31
10.1.3	Neutral, 230 VAC .....	32
10.1.4	Neutral, 115 VAC .....	33
11	Lighting Surge .....	34
11.1	Differential Mode Test.....	34
11.1.1	1000 V 90° Differential Mode Surge .....	34
11.1.2	-1000 V 270° Differential Mode Surge .....	35
12	Revision History .....	36

**Important Note:**

Although this board is designed to satisfy safety isolation requirements, the engineering prototype has not been agency approved. Therefore, all testing should be performed using an isolation transformer to provide the AC input to the prototype board.



# 1 Introduction

This document is an engineering prototype report describing a non-isolated 12 V, 120 mA power supply utilizing a LNK3294G/P from Power Integrations. The document contains the power supply specification, schematic, bill-of-materials, printed circuit layout, and performance data.

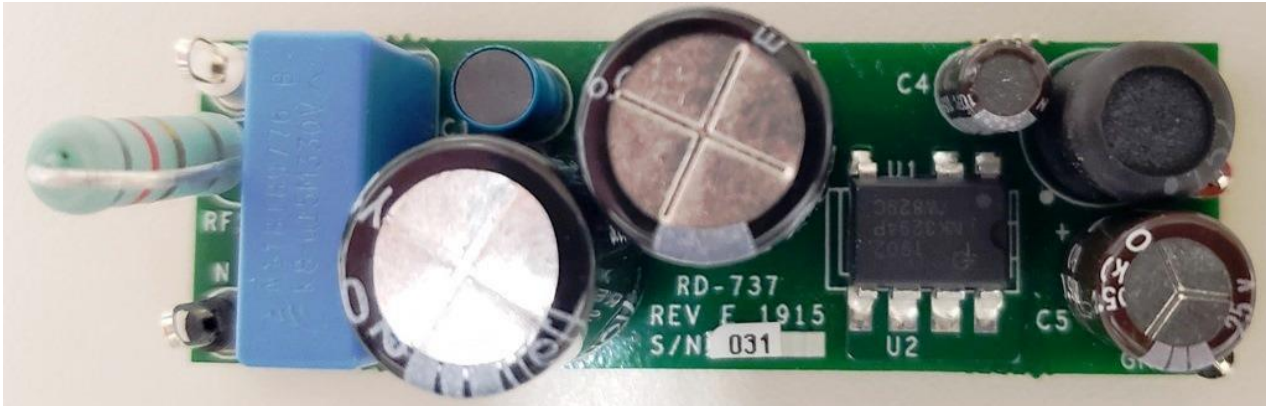


Figure 1– Populated Circuit Board Photograph, Top.



Figure 2 – Populated Circuit Board Photograph, Bottom.

## 2 Power Supply Specification

The table below represents the minimum acceptable performance of the design. Actual performance is listed in the results section.

Description	Symbol	Min	Typ	Max	Units	Comment	
<b>Input</b>							
Voltage	$V_{IN}$	85		440	VAC	2 Wire – no P.E.	
Frequency	$f_{LINE}$	47	50/60	64	Hz		
No-load Input Power (230 VAC)				<30	mW		
<b>Output</b>							
Output Voltage	$V_{OUT}$		12		V	±5%. 20 MHz Bandwidth.	
Output Ripple Voltage	$V_{RIPPLE}$			150	mV		
Output Current	$I_{OUT}$		0.12		A		
<b>Total Output Power</b>							
Continuous Output Power	$P_{OUT}$		1.44		W		
Peak Output Power	$P_{OUT PEAK}$				W		
<b>Efficiency</b>							
Full Load (440Vac)	$\eta$	73			%	Measured at the End of PCB. 25 °C.	
<b>Environmental</b>							
Conducted EMI		Meets CISPR22B / EN55022B					
Line Surge Differential Mode (L1-L2)			1		kV	1.2/50 $\mu$ s surge, IEC 61000-4-5, Series Impedance: Differential Mode: 2 $\Omega$ .	
Ambient Temperature	$T_{AMB}$	0		40	°C	Free Convection, Sea Level.	

### 3 Schematic

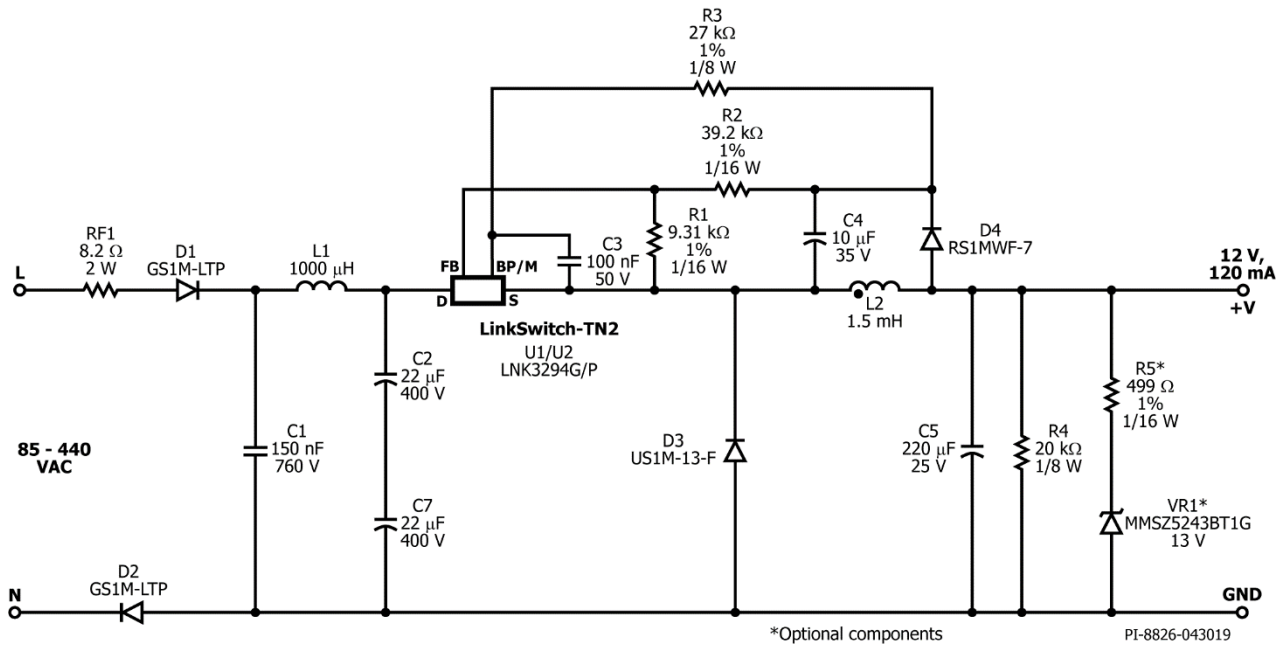


Figure 3 – Schematic.

Note:

1. U1 can be implemented as LNK3294G or U2 for LNK3294P.
2. \*VR1 and \*R5 are optional components. Please see circuit description.

## 4 Circuit Description

The schematic in Figure 3 shows a buck converter using LNK3294G/P. The circuit provides a non-isolated 12 V, 120 mA continuous output. In metering applications this is used to supply the control circuits and micro controller. The 900 V LinkSwitch-TN2 integrates a 900 V MOSFET and control circuitry into a single low cost IC. Regulation is achieved using a low cost resistor divider feedback network. The switching frequency jitter feature of the LinkSwitch-TN2 family and the 66 kHz switching frequency of operation helps reduce EMI.

### 4.1 *Input EMI Filtering*

The input stage is comprised of fusible resistor RF1, diode D1 and D2, capacitors C1, C2 and C7, and inductor L1. Resistor RF1 is a flameproof, fusible, wire-wound resistor. It accomplishes several functions: (a) limits inrush current to safe levels for rectifiers D1, D2 (b) provides differential mode noise attenuation and (c) acts as an input fuse in the event any other component fails short-circuit. As this component is used as a fuse, it should fail safely open-circuit without emitting smoke, fire or incandescent material to meet typical safety requirements. To withstand the instantaneous inrush power dissipation, wire wound types are recommended. Metal film resistors are not recommended in place of RF1.

### 4.2 *900 V LinkSwitch-TN2*

The 900 V LinkSwitch-TN2 integrates a 900 V power MOSFET and control circuitry into a single low cost IC. The device is self-starting from the DRAIN (D) pin with local supply decoupling provided by a small 100 nF capacitor C3 connected to the BYPASS (BP/M) pin when AC is first applied. During normal operation the device is powered from output via a current limiting resistor R3. Here, the device LNK3294P is used in a buck converter. The supply is designed to operate in mostly discontinuous conduction mode (MDCM), with the peak L2 inductor current set by the LNK3294P internal current limit. The control scheme used is similar to the ON/OFF control used in TinySwitch™. The on-time for each switching cycle is set by the inductance value of L2, 900 V LinkSwitch-TN2 current limit and the high-voltage DC input bus across C2 and C7. Output regulation is accomplished by skipping switching cycles in response to an ON/OFF feedback signal applied to the FEEDBACK (FB) pin. This differs significantly from traditional PWM schemes that control the duty factor (duty cycle) of each switching cycle. Unlike TinySwitch, the logic of the FB pin has been inverted in LinkSwitch-TN. This allows a very simple feedback scheme to be used when the device is used in the buck converter configuration. Current into the FB pin greater than 49  $\mu$ A will inhibit the switching of the internal MOSFET, while current below this allows switching cycles to occur.

### 4.3 **Output Rectification**

During the ON time of U1, current ramps in L2 and is simultaneously delivered to the load. During the OFF time the inductor current ramps down via free-wheeling diode D3 into C5 and is delivered to the load. Diode D3 should be selected as an ultrafast diode ( $t_{RR}$  of 35 ns or better is recommended). Capacitor C5 should be selected to have an adequate ripple current rating (low ESR type). Please see the spreadsheet output capacitor section.

### 4.4 **Output Feedback**

The voltage across L2 is rectified and smoothed by D4 and C4 during the off-time of U1. To provide a feedback signal, the voltage developed across C4 is divided by R1 and R2 and connected to U1's FB pin. The values of R1 and R2 are selected such that at the nominal output voltage, the voltage on the FB pin is 2 V. R1 and R2 can be optimized for better output voltage regulation and efficiency. This voltage is specified for U1 at an FB pin current of 49  $\mu$ A with a tolerance of  $\pm 1.3\%$  over a temperature range of -40 to 125  $^{\circ}$ C. This allows this simple feedback to meet the required overall output tolerance of  $\pm 5\%$  at rated output current.

### 4.5 **Optional Components**

Zener diode VR1 and R5 are optional components. VR1 and R5 are used to limit the desired output voltage during brown in.



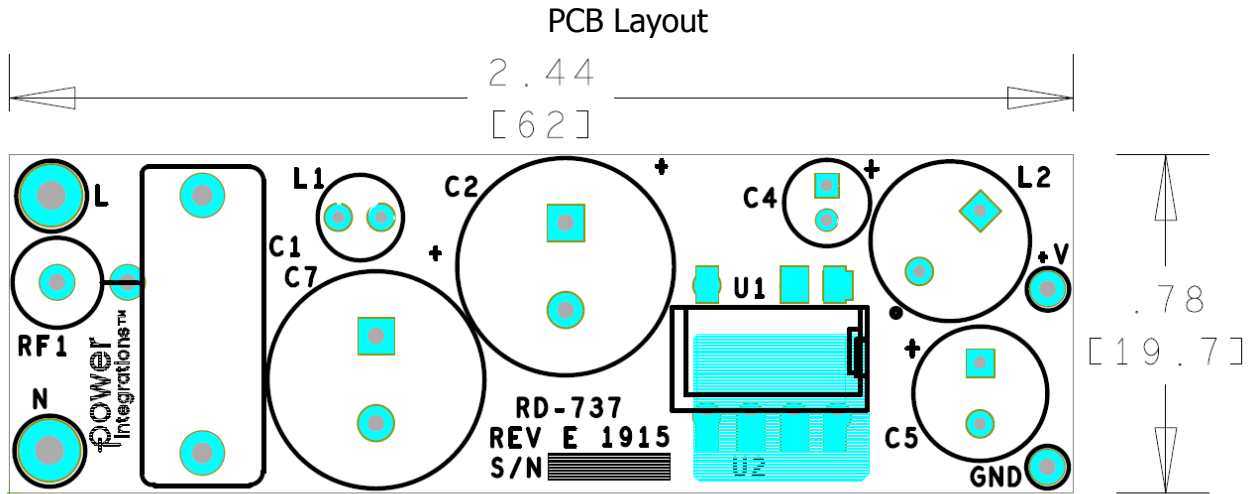


Figure 4 – Printed Circuit Layout, Top (2.44" [62 mm] L x .78" [19.7 mm] W).

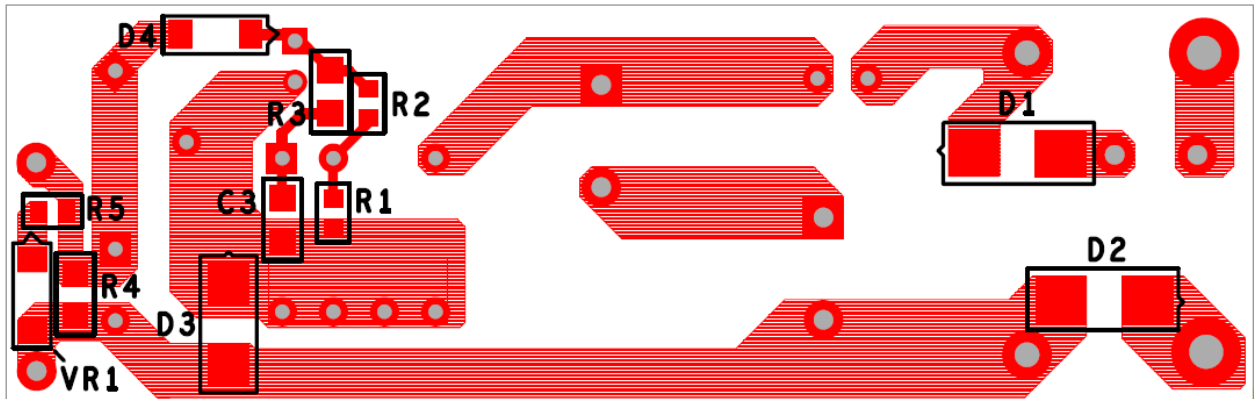


Figure 5 – Printed Circuit Layout, Bottom.

## 5 Bill of Materials

Item	Qty	Ref Des	Description	Mfg Part Number	Mfg
1	2	C2 C7	22 $\mu$ F, 400 V, Electrolytic, (12.5 x 16)	TYB2GM220J160	Ltec
2	1	C1	150 nF, 760 V, Polypropylene Film	B32912B3154M	Epcos
3	1	C3	100 nF, 50 V, Ceramic, X7R, 0805	CC0805KRX7R9BB104	Yageo
4	1	C4	10 $\mu$ F, 35 V, Electrolytic, Gen Purpose, (5 x 7)	UPW1V100MDD6	Nichicon
5	1	C5	220 $\mu$ F, 25 V, Electrolytic, Very Low ESR, 72 m $\Omega$ , (8 x 11.5)	EKZE250ELL221MHB5D	Nippon Chemi-Con
6	2	D1 D2	1000 V, 1 A, DO-214AC	GS1M-LTP	Micro Commercial
7	1	D3	1000 V, 1 A, Ultrafast Recovery, GPP, DO-214AC SMA	US1M-13-F	Diode Inc.
8	1	D4	1000 V, 1 A, General Purpose, Fast Recovery = < 500 ns, trr = 500 ns, SOD123F	RS1MWF-7	Diodes, Inc.
9	1	L1	1000 $\mu$ H, 0.21 A, 5.5 x 10.5 mm	SBC1-102-211	Tokin
10	1	L2	INDUCTOR, FIXED, 1.5 mH, 430 mA, 3.8 $\Omega$ , TH	RLB9012-152KL	Bourns
11	1	R1	RES, 9.31 k, 1%, 1/16 W, Thick Film, 0603	ERJ-3EKF9311V	Panasonic
12	1	R2	RES, 39.2 k $\Omega$ , 1%, 1/16 W, Thick Film, 0603	ERJ-3EKF3922V	Panasonic
13	1	R3	RES, 27 k $\Omega$ , 1%, 1/8 W, 0805 (2012 Metric), Moisture Resistant, Thick Film	RC0805FR-0727KL	Yageo
14	1	R4	RES, 20 k, 5%, 1/8 W, Thick Film, 0805	ERJ-6GEYJ203V	Panasonic
15	1	R5	RES, 499 $\Omega$ , 1%, 1/16 W, Thick Film, 0603	ERJ-3EKF4990V	Panasonic
16	1	RF1	RES, 8.2 $\Omega$ , 2 W, Fusible/Flame Proof Wire Wound	603-FKN200JR-73-8R2	Yageo
17	1	VR1	13 V, 5%, 500 mW, SOD-123	MMSZ5243BT1G	ON Semi
18	1	U1/U2	900 V LinkSwitch-TN2 IC	LNK3294G/P	Power Integrations

### Miscellaneous Parts

Item	Qty	Ref Des	Description	Mfg Part Number	Mfg
1	1	L	Test Point, WHT, THRU-HOLE MOUNT	5012	Keystone
2	1	N	Test Point, BLK, THRU-HOLE MOUNT	5011	Keystone
3	1	+V	Test Point, RED, Miniature THRU-HOLE MOUNT	5000	Keystone
4	1	GND	Test Point, BLK, Miniature THRU-HOLE MOUNT	5001	Keystone



## 6 Design Spreadsheet

ACDC_LinkSwitchTN2_900V_Buck_011919; Rev.1.1; Copyright Power Integrations 2019	INPUT	INFO	OUTPUT	UNIT	ACDC LinkSwitchTN2 900V Buck
<b>APPLICATION VARIABLES</b>					
LINE VOLTAGE RANGE			Custom		AC line voltage range
VACMIN	85.00		85.00	V	Minimum AC line voltage
VACTYP			115.00	V	Typical AC line voltage
VACMAX	440.00		440.00	V	Maximum AC line voltage
fL	50.00		50.00	Hz	AC mains frequency
LINE RECTIFICATION TYPE	H		H		Select 'F'ull wave rectification or 'H'alf wave rectification
VOUT			12.00	V	Output voltage
IOUT	0.120		0.120	A	Average output current
EFFICIENCY_ESTIMATED			0.80		Efficiency estimate at output terminals
EFFICIENCY_CALCULATED			0.74		Calculated efficiency based on real components and operating point
POUT			1.44	W	Continuous Output Power
CIN	11.00		11.00	uF	Input capacitor
VMIN			93.4	V	Valley of the rectified input voltage
VMAX			622.3	V	Peak of the rectified maximum input AC voltage
T_AMBIENT			50	degC	Operating ambient temperature in degrees celcius
INPUT STAGE RESISTANCE			10	Ohms	Input stage resistance (includes fuse, thermistor, filtering components)
PLOSS_INPUTSTAGE			0.004	W	Input stage losses estimate
<b>CONTROLLER SELECTION</b>					
OPERATION MODE			MDCM		Mostly discontinuous mode of operation
CURRENT LIMIT MODE	STD		STD		Choose 'RED' for reduced current limit or 'STD' for standard current limit
PACKAGE	PDIP-8C		PDIP-8C		Select the device package
DEVICE SERIES	Auto		LNK3294		Generic device selection
DEVICE CODE			LNK3294P		Device code
ILIMITMIN			0.240	A	Minimum current limit of the device
ILIMITTYP			0.257	A	Typical current limit of the device
ILIMITMAX			0.275	A	Maximum current limit of the device
RDSON			31.00	ohms	Switch on-time drain to source resistance at 100degC
FSMIN			62000	Hz	Minimum switching frequency
FSTYP			68000	Hz	Typical switching frequency
FSMAX			72000	Hz	Maximum switching frequency
BVDSS			900	V	Primary switch breakdown voltage
<b>SWITCH PARAMETERS</b>					
VDSON			2.00	V	Switch on-time drain to source voltage estimate
DUTY			0.25		Maximum duty cycle
TIME_ON			4.081	us	Switch conduction time at the minimum line voltage
TIME_ON_MIN			0.628	us	Switch conduction time at the maximum line voltage
KP_TRANSIENT			0.153		KP under conditions of a transient
IRMS_MOSFET			0.070	A	Switch RMS current
PLOSS_MOSFET			0.185	W	Primary switch loss estimate
<b>BUCK INDUCTOR PARAMETERS</b>					
INDUCTANCE_MIN			1350	uH	Minimum design inductance required for power delivery
INDUCTANCE_TYP	1500		1500	uH	Typical design inductance required for power delivery
INDUCTANCE_MAX			1650	uH	Maximum design inductance required for power delivery
TOLERANCE_INDUCTANCE			10	%	Tolerance of the design inductance
DC RESISTANCE OF INDUCTOR			2.0	ohms	DC resistance of the buck inductor
FACTOR_LOSS			0.900		Factor that accounts for "off-state" power loss to be supplied by inductor
IRMS_INDUCTOR			0.188	A	Inductor RMS current
PLOSS_INDUCTOR			0.070	W	Inductor losses

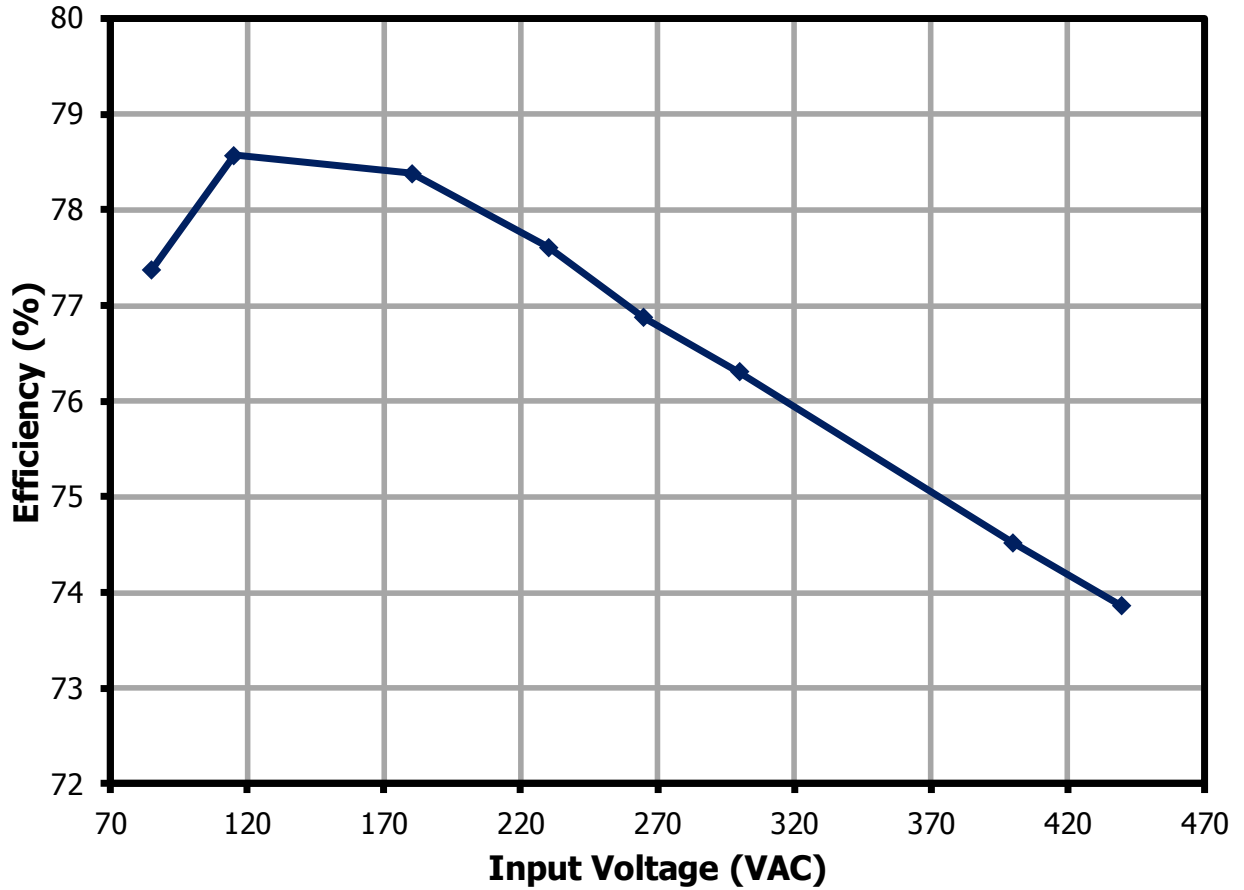
<b>FREEWHEELING DIODE PARAMETERS</b>					
VF_FREEWHEELING	1.7		1.7	V	Forward voltage drop of the freewheeling diode
PIV_CALCULATED			778	V	Peak inverse voltage of the freewheeling diode
IRMS_DIODE			0.168	A	Diode RMS current
TRR			75	ns	Reverse recovery time of the recommended diode
PLOSS_DIODE			0.299	W	Freewheeling diode(s) total losses
RECOMMENDED DIODE			UF4007		Recommended freewheeling diode
<b>BIAS/FEEDBACK PARAMETERS</b>					
VF_BIAS			0.70	V	Forward voltage drop of the bias diode
RBIAS			2490	Ohms	Bias resistor
RBP			0.1	uF	BP pin capacitor
RFB			13000	Ohms	Feedback resistor (Trim this value to meet specific application)
CFB			10	uF	Feedback capacitor
C_SOFTSTART			1-10	uF	If the output voltage is greater than 12 V or total output and system capacitance is greater than 100 uF, a soft start capacitor between 1uF and 10 uF is recommended
PLOSS_FEEDBACK			0.009	W	Feedback section losses
<b>OUTPUT CAPACITOR</b>					
OUTPUT VOLTAGE RIPPLE			0.240	V	Desired output voltage ripple
IRIPPLE_COUT			0.240	A	Output capacitor ripple current
ESR_COUT			1.000	Ohms	Maximum ESR of the output capacitor



## 7 Performance Data

All measurements performed at room temperature.

### 7.1 Efficiency vs. Line



**Figure 6** – Full Load (120 mA) Efficiency vs. Line Voltage, Room Temperature.



7.2 **Efficiency vs. Load**

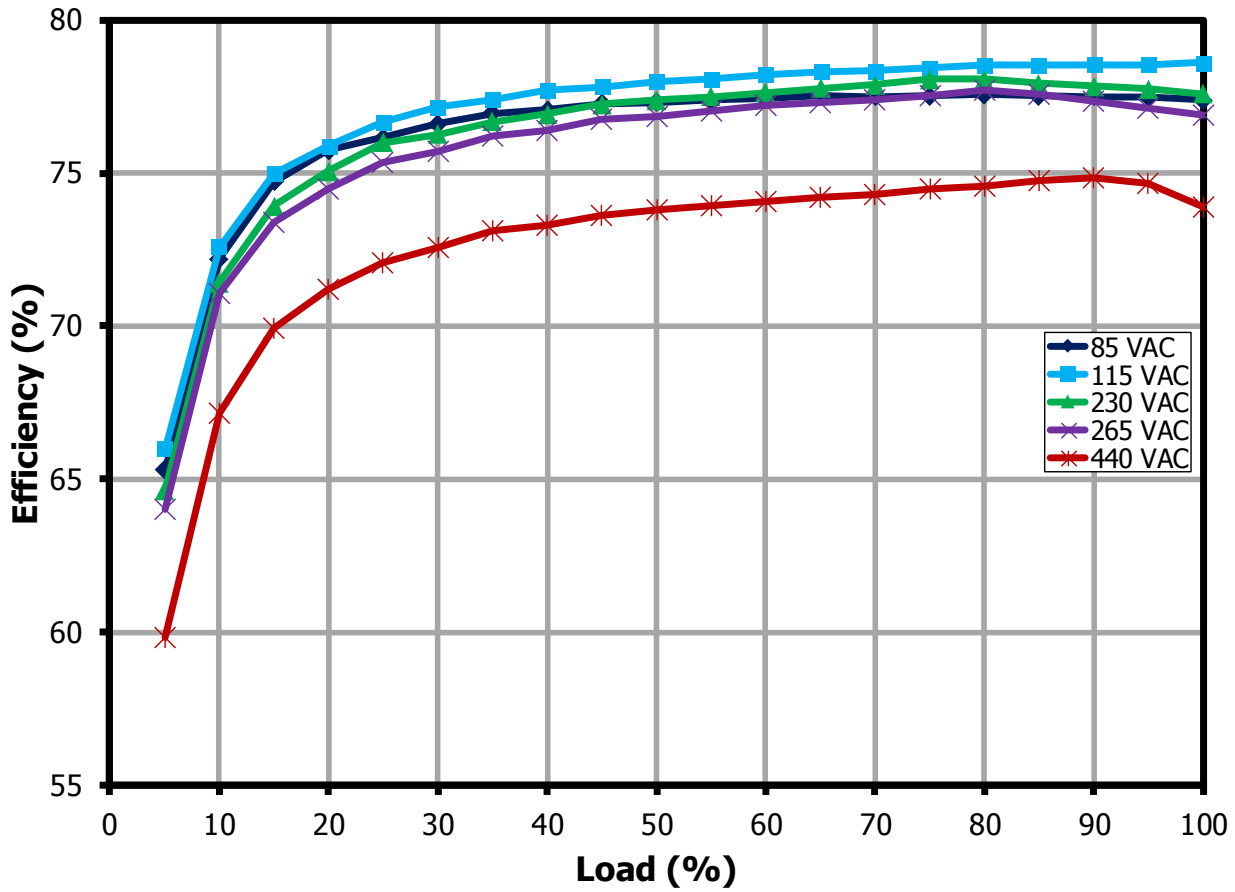


Figure 7 – Efficiency vs. Load, Room Temperature.

### 7.3 Average Efficiency

#### 7.3.1 85 VAC / 60 Hz

Load (A)	V <sub>IN</sub> (V <sub>RMS</sub> )	I <sub>IN</sub> (A <sub>RMS</sub> )	P <sub>IN</sub> (W)	V <sub>OUT</sub> at PCB (V <sub>DC</sub> )	I <sub>OUT</sub> (A <sub>DC</sub> )	P <sub>OUT</sub> (W)	Efficiency at PCB (%)
100%	85	51.6	1.82	11.80	119.4	1.409	77.4
75%	85	39.5	1.36	11.82	89.3	1.055	77.5
50%	85	27.4	0.91	11.85	59.3	0.702	77.3
25%	85	14.8	0.46	11.89	29.3	0.348	76.2
						<b>Average</b>	<b>77.1</b>

#### 7.3.2 115 VAC / 60 Hz

Load (A)	V <sub>IN</sub> (V <sub>RMS</sub> )	I <sub>IN</sub> (A <sub>RMS</sub> )	P <sub>IN</sub> (W)	V <sub>OUT</sub> at PCB (V <sub>DC</sub> )	I <sub>OUT</sub> (A <sub>DC</sub> )	P <sub>OUT</sub> (W)	Efficiency at PCB (%)
100%	115	39.7	1.79	11.80	119.3	1.408	78.6
75%	115	30.7	1.34	11.81	89.3	1.054	78.4
50%	115	21.5	0.9	11.84	59.3	0.702	78.0
25%	115	11.7	0.45	11.89	29.3	0.348	76.7
						<b>Average</b>	<b>77.9</b>

#### 7.3.3 230 VAC / 50 Hz

Load (A)	V <sub>IN</sub> (V <sub>RMS</sub> )	I <sub>IN</sub> (A <sub>RMS</sub> )	P <sub>IN</sub> (W)	V <sub>OUT</sub> at PCB (V <sub>DC</sub> )	I <sub>OUT</sub> (A <sub>DC</sub> )	P <sub>OUT</sub> (W)	Efficiency at PCB (%)
100%	230	24.0	1.81	11.78	119.3	1.406	77.6
75%	230	18.5	1.35	11.80	89.3	1.054	78.1
50%	230	13.0	0.91	11.83	59.3	0.701	77.4
25%	230	7.1	0.46	11.88	29.3	0.348	76.0
						<b>Average</b>	<b>77.3</b>

#### 7.3.4 265 VAC / 50 Hz

Load (A)	V <sub>IN</sub> (V <sub>RMS</sub> )	I <sub>IN</sub> (A <sub>RMS</sub> )	P <sub>IN</sub> (W)	V <sub>OUT</sub> at PCB (V <sub>DC</sub> )	I <sub>OUT</sub> (A <sub>DC</sub> )	P <sub>OUT</sub> (W)	Efficiency at PCB (%)
100%	265	21.7	1.83	11.78	119.3	1.405	76.9
75%	265	16.7	1.36	11.80	89.3	1.053	77.5
50%	265	11.7	0.91	11.83	59.3	0.701	76.9
25%	265	6.4	0.46	11.87	29.3	0.348	75.3
						<b>Average</b>	<b>76.7</b>

#### 7.3.5 440 VAC / 50 Hz

Load (A)	V <sub>IN</sub> (V <sub>RMS</sub> )	I <sub>IN</sub> (A <sub>RMS</sub> )	P <sub>IN</sub> (W)	V <sub>OUT</sub> at PCB (V <sub>DC</sub> )	I <sub>OUT</sub> (A <sub>DC</sub> )	P <sub>OUT</sub> (W)	Efficiency at PCB (%)
100%	440	15.3	1.90	11.77	119.3	1.405	73.9
75%	440	11.8	1.41	11.80	89.3	1.053	74.5
50%	440	8.3	0.95	11.82	59.3	0.701	73.8
25%	440	4.6	0.48	11.87	29.3	0.348	72.0
						<b>Average</b>	<b>73.5</b>

### 7.4 Standby Mode Efficiency

Test Condition: Soak at full load for 5 minutes and decrease load to standby mode for 5 minutes for each line step.

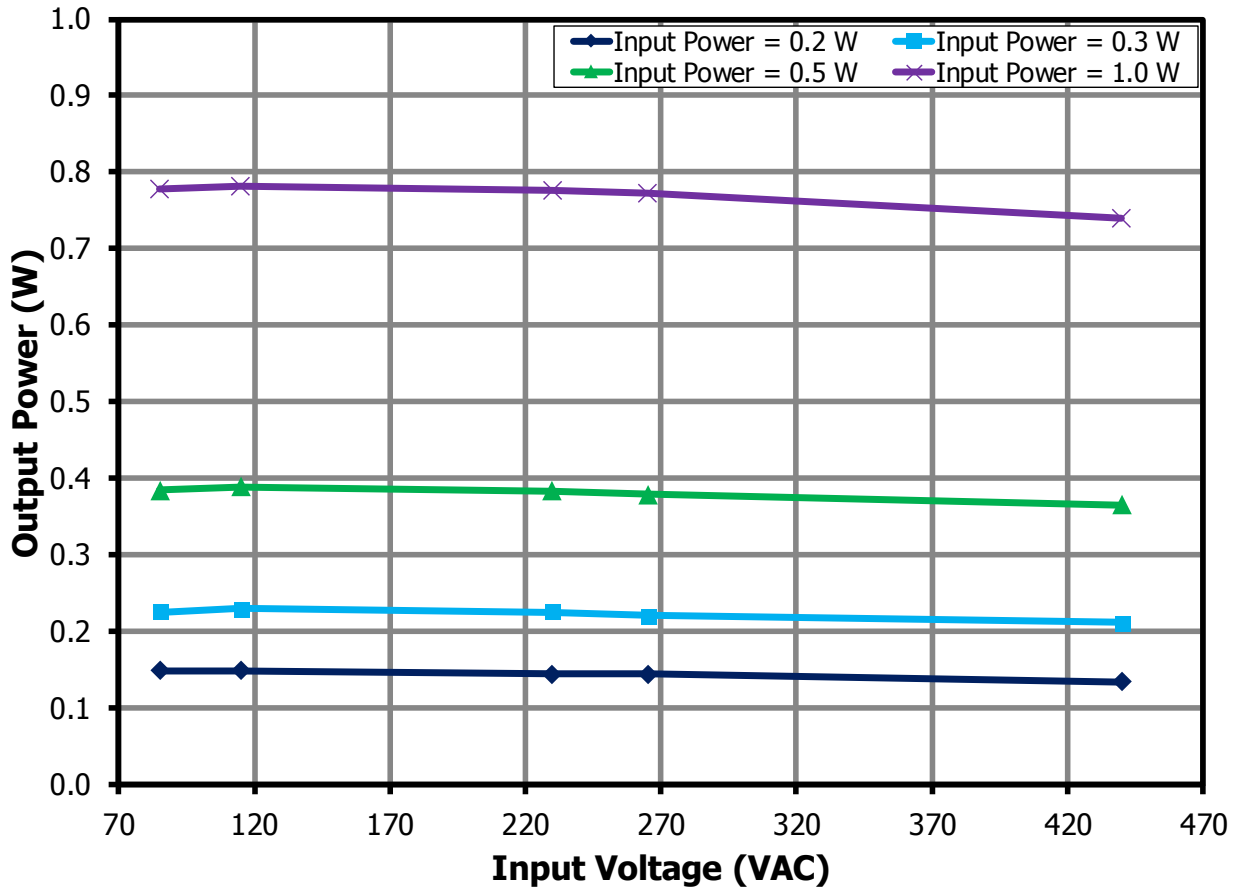


Figure 8 – Available Output Power per Input Power.



## 7.4.1 0.2 W Input Power

Input Measurement			Output 1 Measurement			Efficiency (%)
V <sub>IN</sub> (RMS)	I <sub>IN</sub> (mA)	P <sub>IN</sub> (W)	V <sub>OUT</sub> (V)	I <sub>OUT</sub> (mA)	P <sub>OUT</sub> (W)	
85	7.2	0.20	11.96	12.4	0.148	73.0
115	5.7	0.20	11.95	12.4	0.148	73.2
230	3.4	0.20	11.94	12.0	0.144	71.8
265	3.0	0.20	11.94	12.0	0.144	71.3
440	2.1	0.20	11.94	11.2	0.134	67.0

## 7.4.2 0.3 W Input Power

Input Measurement			Output 1 Measurement			Efficiency (%)
V <sub>IN</sub> (RMS)	I <sub>IN</sub> (mA)	P <sub>IN</sub> (W)	V <sub>OUT</sub> (V)	I <sub>OUT</sub> (mA)	P <sub>OUT</sub> (W)	
85	10.2	0.30	11.92	18.9	0.225	75.0
115	8.2	0.30	11.92	19.3	0.230	75.4
230	4.9	0.30	11.90	18.9	0.225	74.3
265	4.4	0.30	11.91	18.5	0.220	73.7
440	3.0	0.30	11.90	17.7	0.211	69.9

## 7.4.3 0.5 W Input Power

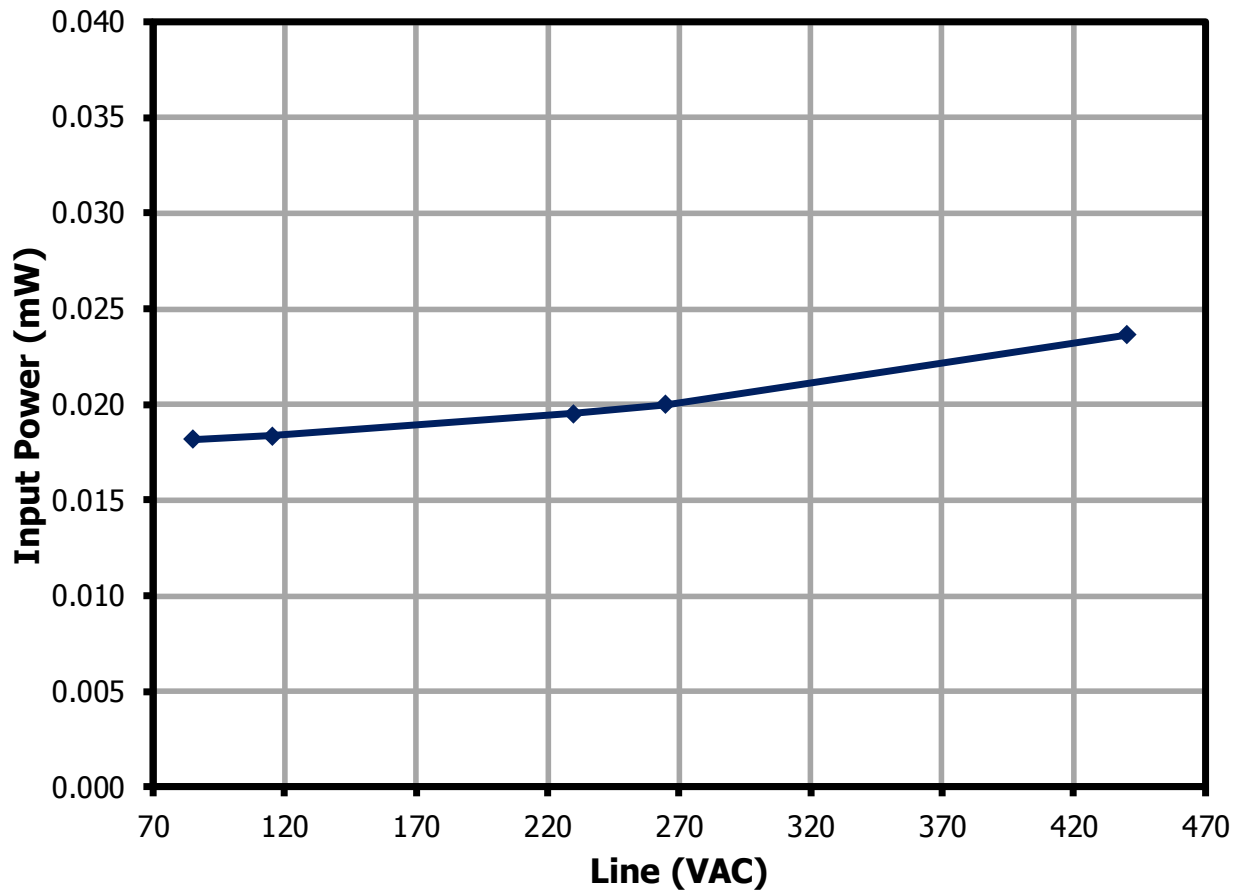
Input Measurement			Output 1 Measurement			Efficiency (%)
V <sub>IN</sub> (RMS)	I <sub>IN</sub> (mA)	P <sub>IN</sub> (W)	V <sub>OUT</sub> (V)	I <sub>OUT</sub> (mA)	P <sub>OUT</sub> (W)	
85	16.1	0.50	11.89	32.3	0.384	76.6
115	12.8	0.50	11.88	32.7	0.389	77.1
230	7.7	0.50	11.87	32.3	0.384	76.2
265	6.9	0.50	11.87	31.9	0.379	75.7
440	4.8	0.50	11.87	30.8	0.365	72.3

## 7.4.4 1.0 W Input Power

Input Measurement			Output 1 Measurement			Efficiency (%)
V <sub>IN</sub> (RMS)	I <sub>IN</sub> (mA)	P <sub>IN</sub> (W)	V <sub>OUT</sub> (V)	I <sub>OUT</sub> (mA)	P <sub>OUT</sub> (W)	
85	29.9	1.00	11.84	65.7	0.778	77.5
115	23.5	1.00	11.84	66.1	0.782	78.2
230	14.2	1.00	11.83	65.7	0.777	77.5
265	12.7	1.00	11.82	65.3	0.772	77.0
440	8.7	1.00	11.82	62.6	0.740	73.8



### 7.5 *No-Load Input Power*



**Figure 9** – No-Load Input Power vs. Input Line Voltage, Room Temperature.

### 7.6 Load Regulation

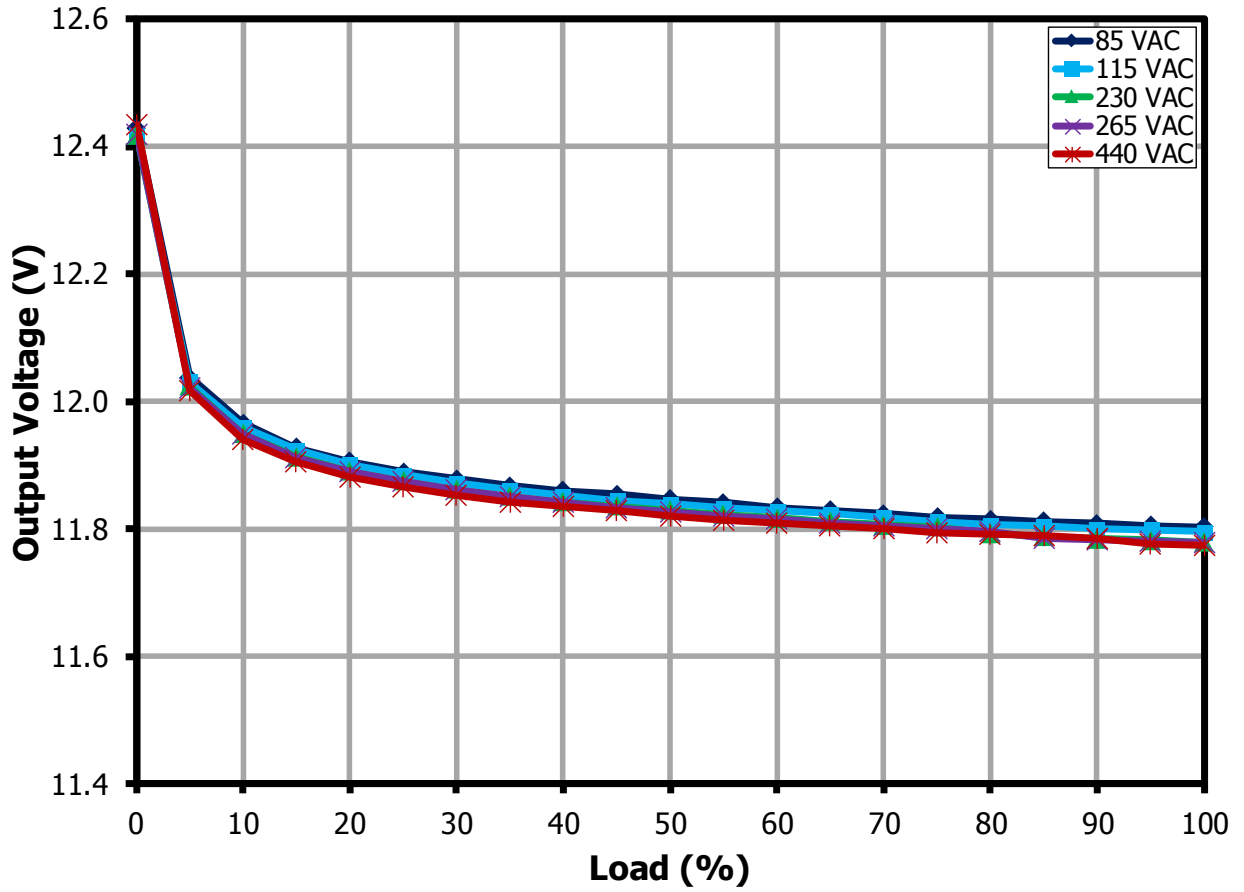
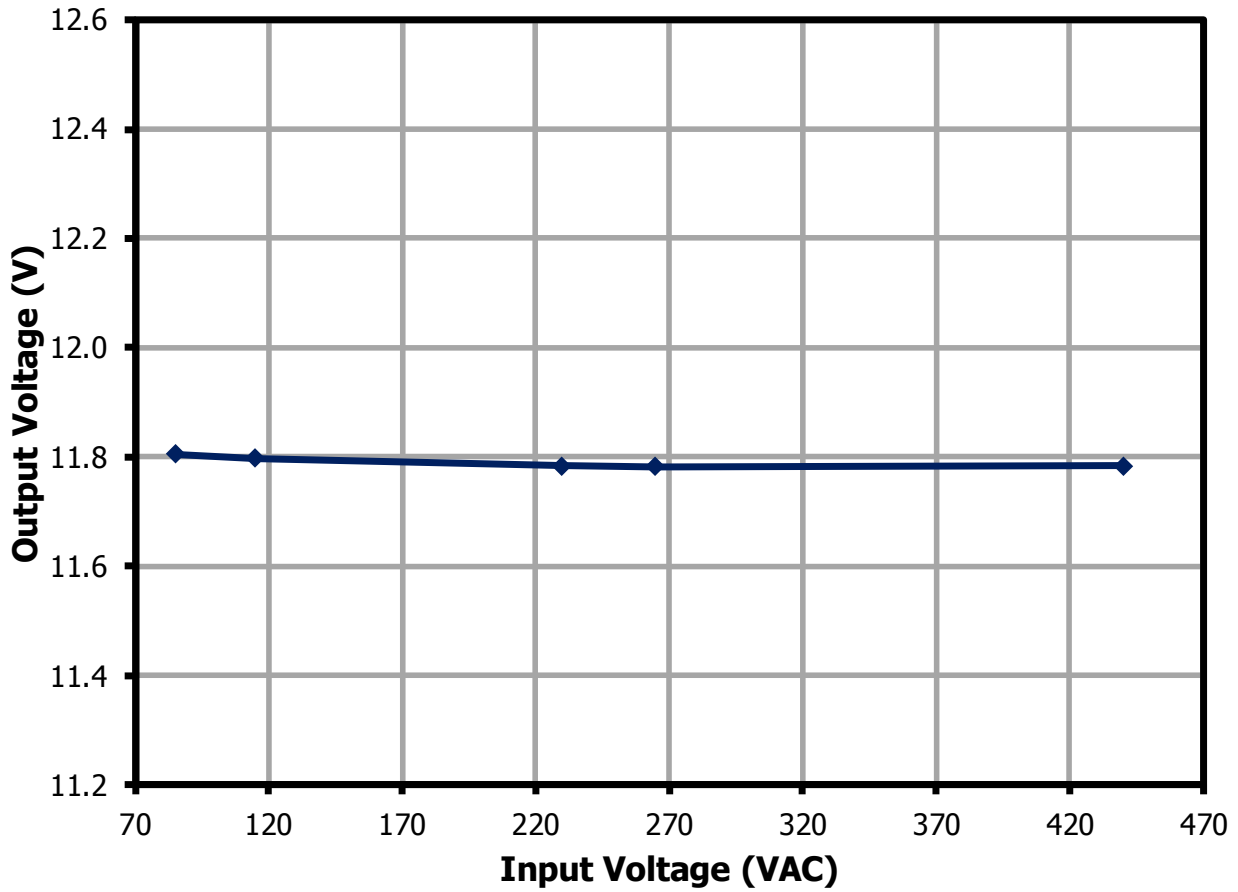


Figure 10 – Output Voltage vs. Output Current, Room Temperature.

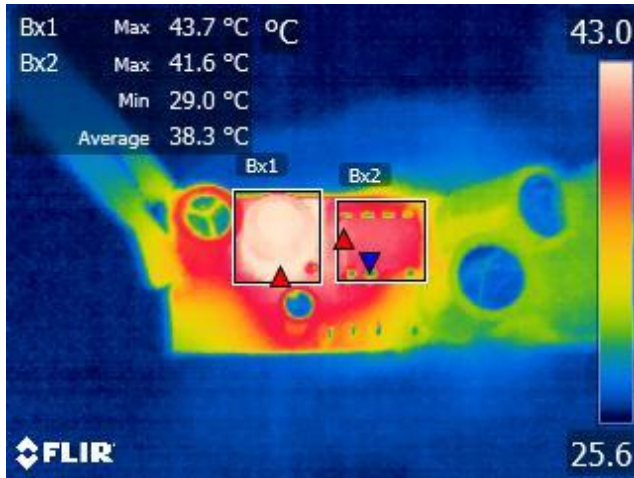


7.7 **Line Regulation at Full Load**

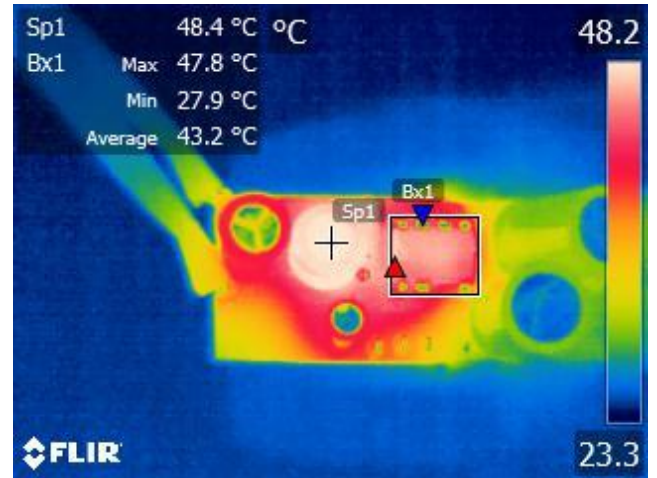


**Figure 11** – Output Voltage vs. Input Voltage, Room Temperature.

## 8 Open Case Thermal Performance



**Figure 12** – LNK3294P Maximum 41.6 °C.  
85 VAC, 120 mA Load.  
Ambient = 27 °C.



**Figure 13** – LNK3294P Maximum 47.8 °C.  
440 VAC, 120 mA Load.  
Ambient = 27.4 °C.

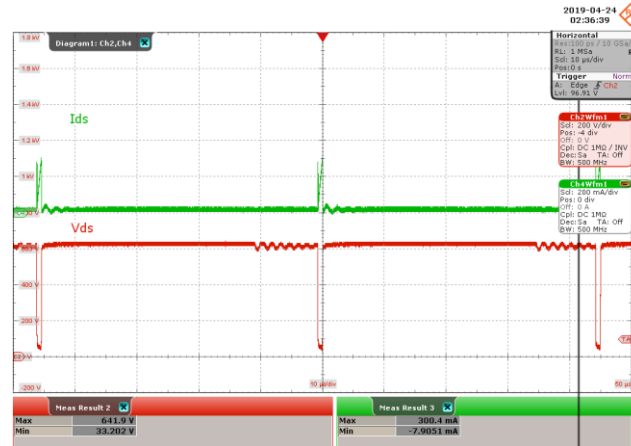
## 9 Waveforms

### 9.1 Switching Waveforms

#### 9.1.1 LNK3294P Waveforms

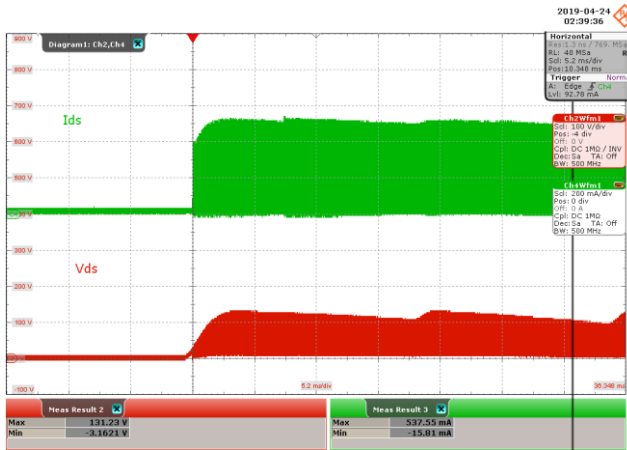


**Figure 14** – Drain Voltage and Current Waveforms.  
 85 VAC, 120 mA Output.  
 Upper:  $I_{DRAIN}$ , 100 mA / div.  
 Lower:  $V_{DRAIN}$ , 40 V, 10  $\mu$ s / div.  
 $I_{MAX} = 276.7$  mA,  $V_{MAX} = 118.9$  V.



**Figure 15** – Drain Voltage and Current Waveforms.  
 440 VAC, 120 mA Output.  
 Upper:  $I_{DRAIN}$ , 200 mA / div.  
 Lower:  $V_{DRAIN}$ , 200 V, 10  $\mu$ s / div.  
 $I_{MAX} = 300.4$  mA,  $V_{MAX} = 641.9$  V.

9.1.2 LNK3294P Drain Voltage and Current Waveforms During Start-Up



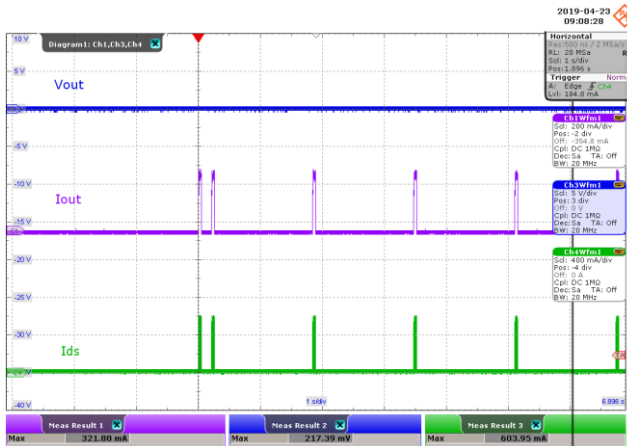
**Figure 16** – Drain Voltage and Current Waveforms.  
 85 VAC, 120 mA Output.  
 Upper:  $I_{DRAIN}$ , 200 mA / div.  
 Lower:  $V_{DRAIN}$ , 100 V, 5.2 ms / div.  
 $I_{MAX} = 537.55 \text{ mA}$ ,  $V_{MAX} = 131.23 \text{ V}$



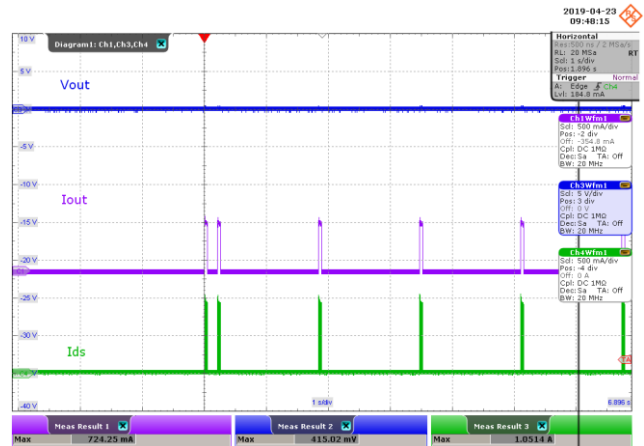
**Figure 17** – Drain Voltage and Current Waveforms.  
 440 VAC, 120 mA Output.  
 Upper:  $I_{DRAIN}$ , 400 mA / div.  
 Lower:  $V_{DRAIN}$ , 200 V, 5.2 ms / div.  
 $I_{MAX} = 1.0593 \text{ A}$ ,  $V_{MAX} = 689.3 \text{ V}$

Note: The peaks are within the SOA limits.

9.1.3 Drain Current and Output Waveform During Output Short



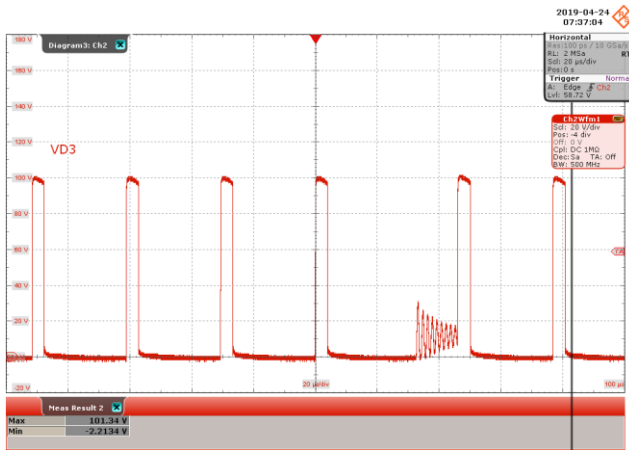
**Figure 18** – Drain Current and Output Waveforms.  
 85 VAC Input.  
 Upper:  $V_{OUT}$ , 5 V, 1 s / div.  
 Middle:  $I_{OUT}$ , 200 mA / div.  
 Lower:  $I_{DRAIN}$ , 400 mA / div.



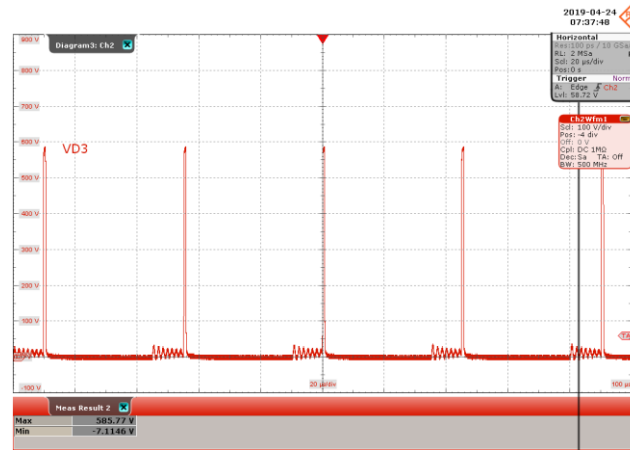
**Figure 19** – Drain Voltage and Output Waveforms.  
 440 VAC Input.  
 Upper:  $V_{OUT}$ , 5 V, 1 s / div.  
 Middle:  $I_{OUT}$ , 500 mA / div.  
 Lower:  $I_{DRAIN}$ , 500 mA / div.



9.1.4 Freewheeling Diode Waveforms



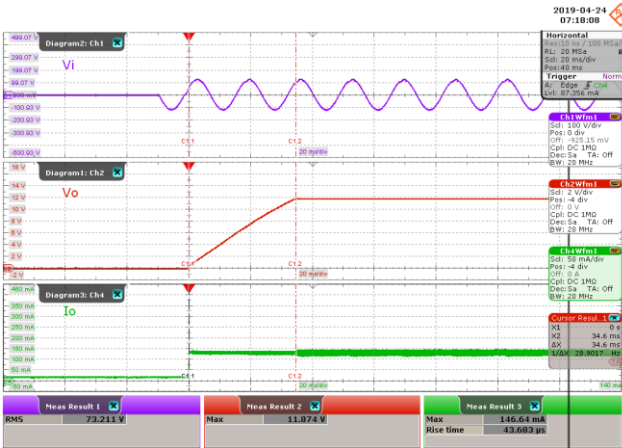
**Figure 20** – Freewheeling Diode Voltage Waveforms.  
 85 VAC, 120 mA Output.  
 20 V, 20 μs / div.  
 $V_{MAX}$ : 101.34 V.



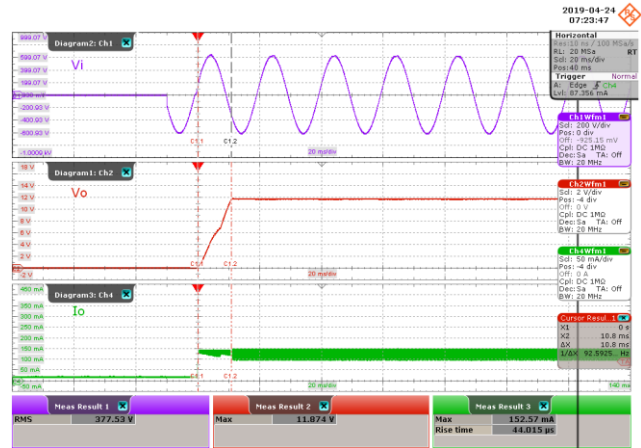
**Figure 21** – Freewheeling Diode Voltage Waveforms.  
 440 VAC, 120 mA Output.  
 100 V, 20 μs / div.  
 $V_{MAX}$ : 585.77 V.



9.1.5 Output Voltage and Current Waveforms During Start-Up (CC mode)



**Figure 22** – Output Voltage and Current Waveforms.  
 85 VAC, 120 mA Output.  
 Upper:  $V_{IN}$ , 100 V, 20 ms / div.  
 Middle:  $V_{OUT}$ , 2 V / div.  
 Lower:  $I_{OUT}$ , 50 mA / div.  
 Rise Time = 34.6 ms.



**Figure 23** – Output Voltage and Current Waveforms.  
 440 VAC, 120 mA Output.  
 Upper:  $V_{IN}$ , 200 V, 20 ms / div.  
 Middle:  $V_{OUT}$ , 2 V / div.  
 Lower:  $I_{OUT}$ , 50 mA / div.  
 Rise Time = 10.8 ms.

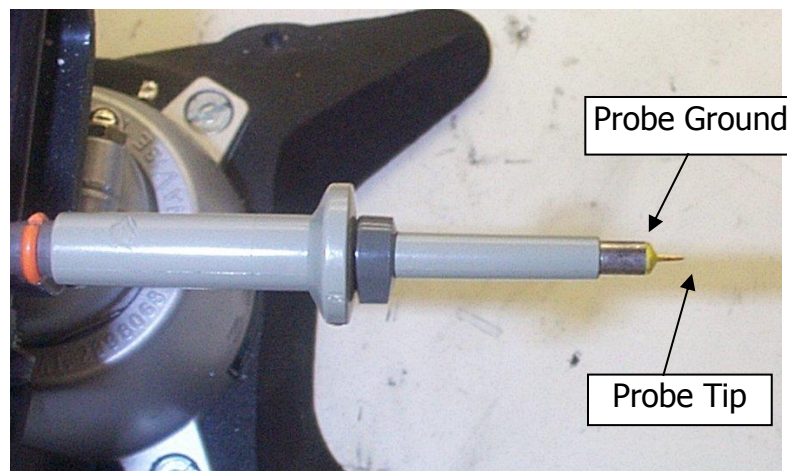


## 9.2 **Output Ripple Measurements**

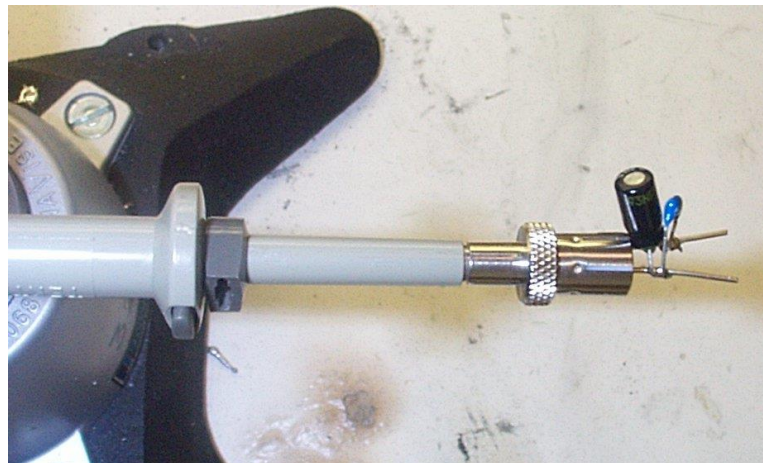
### 9.2.1 Ripple Measurement Technique

For DC output ripple measurements, a modified oscilloscope test probe must be utilized in order to reduce spurious signals due to pick-up. Details of the probe modification are provided in the Figures below.

The 4987BA probe adapter is affixed with two capacitors tied in parallel across the probe tip. The capacitors include one (1) 0.1  $\mu\text{F}$ /50 V ceramic type and one (1) 1  $\mu\text{F}$ /50 V aluminum electrolytic. The aluminum electrolytic type capacitor is polarized, so proper polarity across DC outputs must be maintained (see below).



**Figure 24** – Oscilloscope Probe Prepared for Ripple Measurement. (End Cap and Ground Lead Removed.)



**Figure 25** – Oscilloscope Probe with Probe Master ([www.probemaster.com](http://www.probemaster.com)) 4987A BNC Adapter. (Modified with wires for ripple measurement, and two parallel decoupling capacitors added.)

9.2.2 Measurement Results

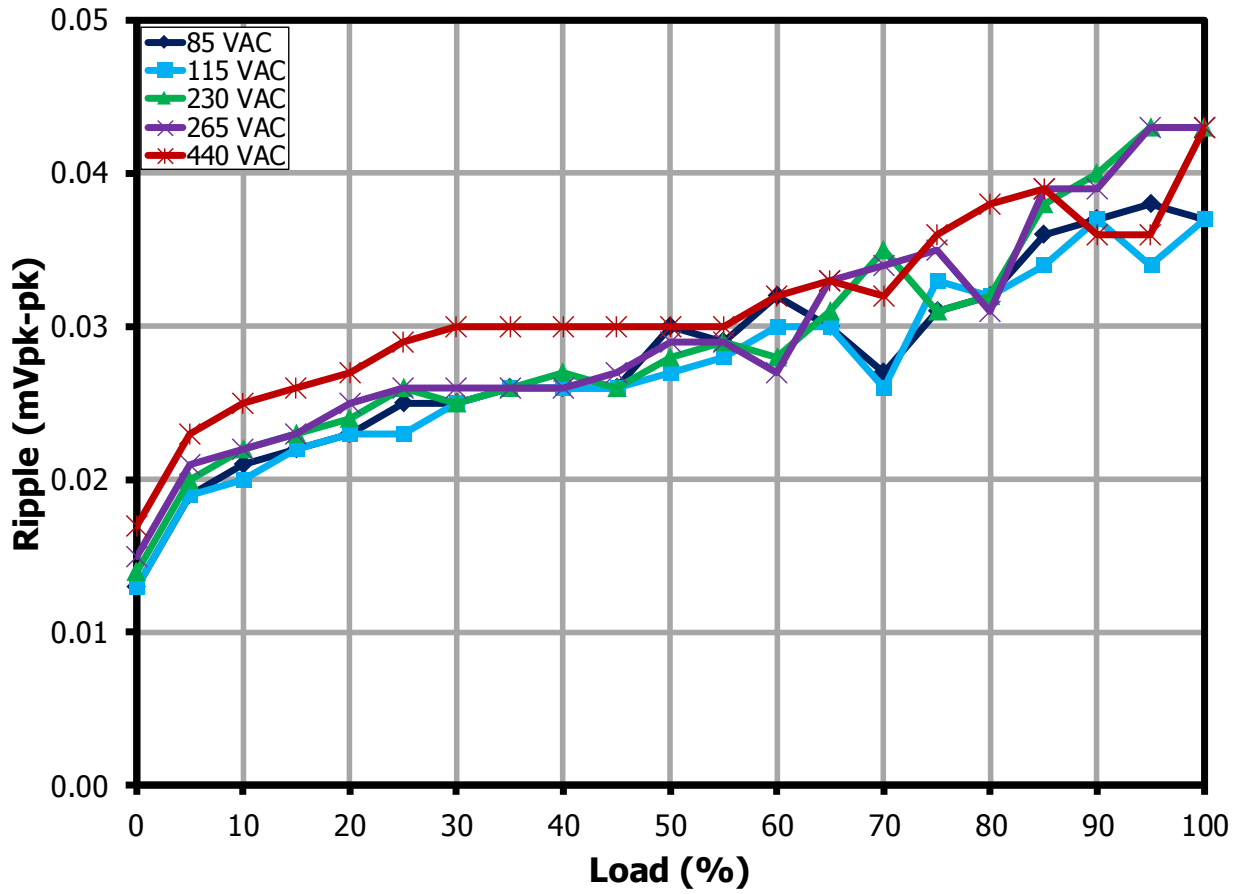
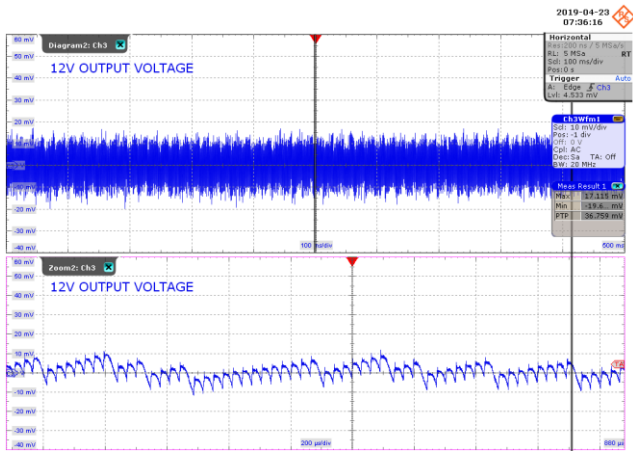


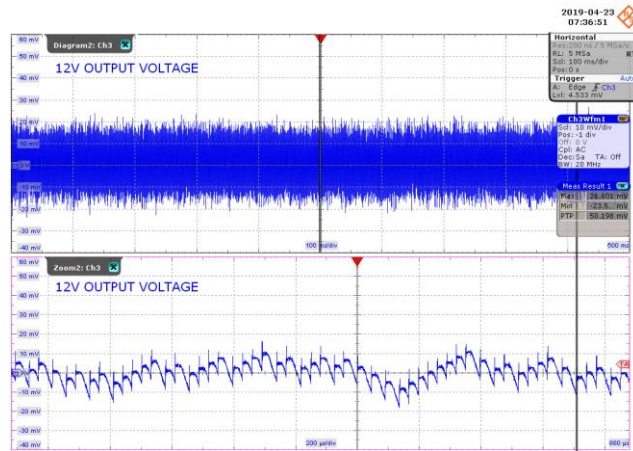
Figure 26 – Output Ripple Voltage.



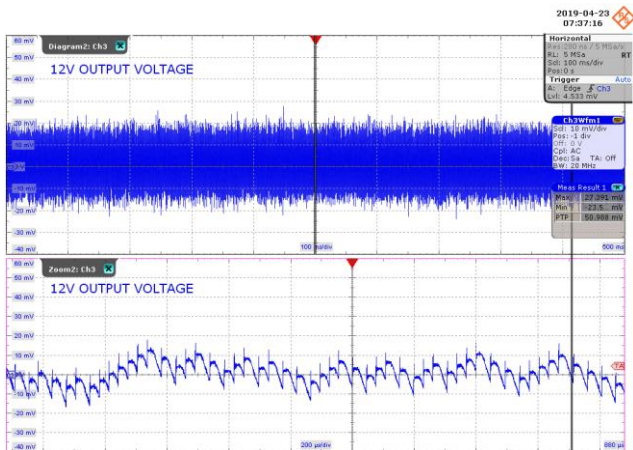
9.2.3 Ripple Voltage Waveforms



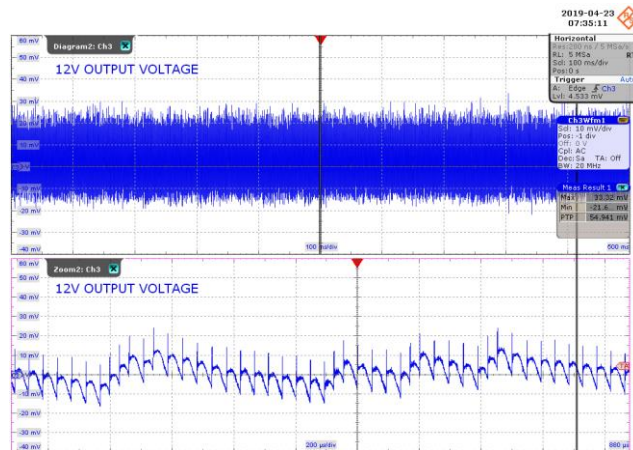
**Figure 27** – Output Voltage Ripple Waveforms.  
 85 VAC, 120 mA Output.  
 10 mV, 100 ms / div.; 200 µs / div.  
 $V_{PK-PK}$ : 36.76 mV.



**Figure 28** – Output Voltage Ripple Waveforms.  
 230VAC, 120 mA Output.  
 10 mV, 100 ms / div.; 200 µs / div.  
 $V_{PK-PK}$ : 50.198 mV.



**Figure 29** – Output Voltage Ripple Waveforms.  
 265 VAC, 120 mA Output.  
 10 mV, 100 ms / div.; 200 µs / div.  
 $V_{PK-PK}$ : 50.988 mV.

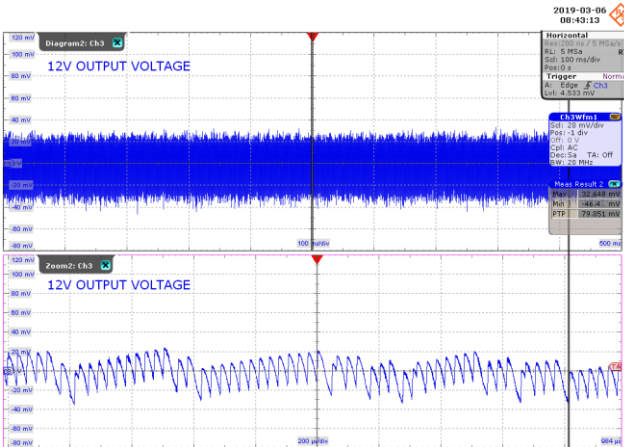


**Figure 30** – Output Voltage Ripple Waveforms.  
 440VAC, 120 mA Output.  
 10 mV, 100 ms / div.; 200 µs / div.  
 $V_{PK-PK}$ : 54.941 mV.

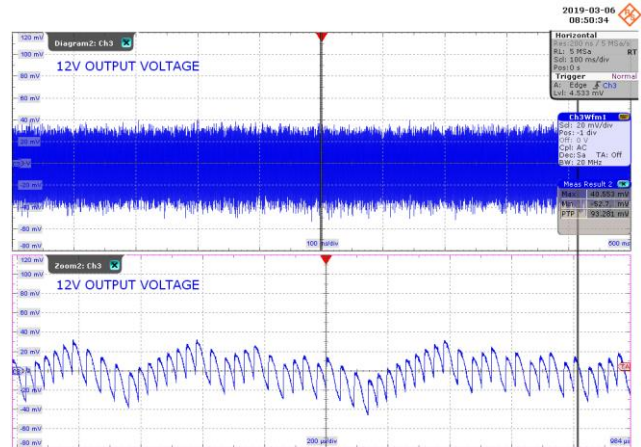


9.2.4 Ripple Voltage Waveforms Using 100  $\mu$ F Output Capacitor

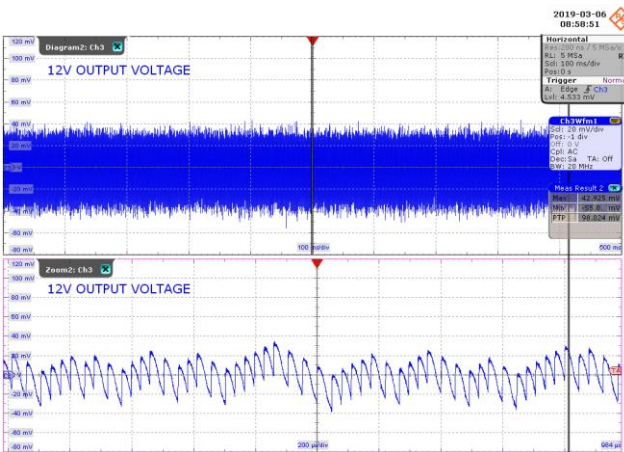
For cost reduction, the output capacitor can be reduced to 100  $\mu$ F Low ESR.



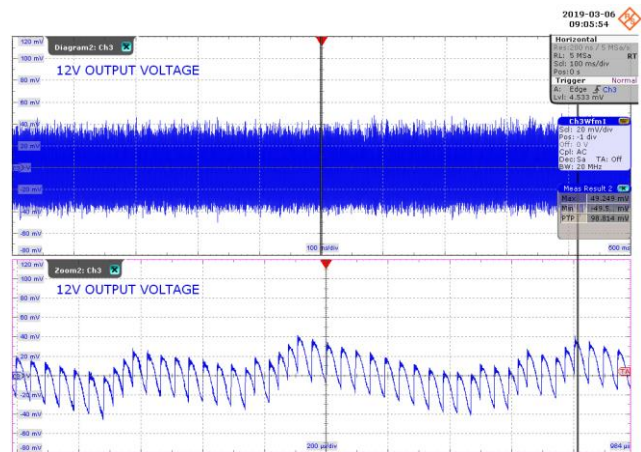
**Figure 31** – Output Voltage Ripple Waveforms.  
 85 VAC, 120 mA Output.  
 20 mV, 100 ms / div.; 200  $\mu$ s / div.  
 $V_{PK-PK}$ : 79.051 mV.



**Figure 32** – Output Voltage Ripple Waveforms.  
 230VAC, 120 mA Output.  
 20 mV, 100 ms / div.; 200  $\mu$ s / div.  
 $V_{PK-PK}$ : 93.281 mV.



**Figure 33** – Output Voltage Ripple Waveforms.  
 265 VAC, 120 mA Output.  
 20 mV, 100 ms / div.; 200  $\mu$ s / div.  
 $V_{PK-PK}$ : 98.024 mV.



**Figure 34** – Output Voltage Ripple Waveforms.  
 440VAC, 120 mA Output.  
 20 mV, 100 ms / div.; 200  $\mu$ s / div.  
 $V_{PK-PK}$ : 98.814 mV.



## 10 Conductive EMI

### 10.1 120 mA Resistive Load, Floating Output (QPK / AV)

After running for 5 minutes.

#### 10.1.1 Line, 230 VAC

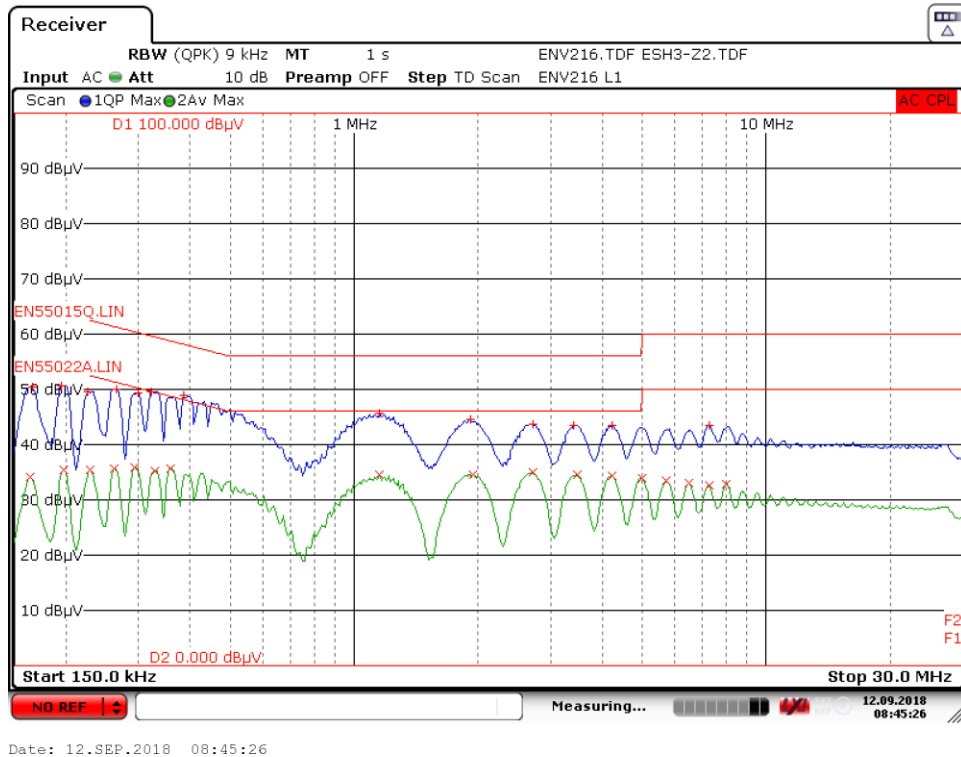


Figure 35 – Floating Ground EMI at 230 VAC.

10.1.2 Line, 115 VAC

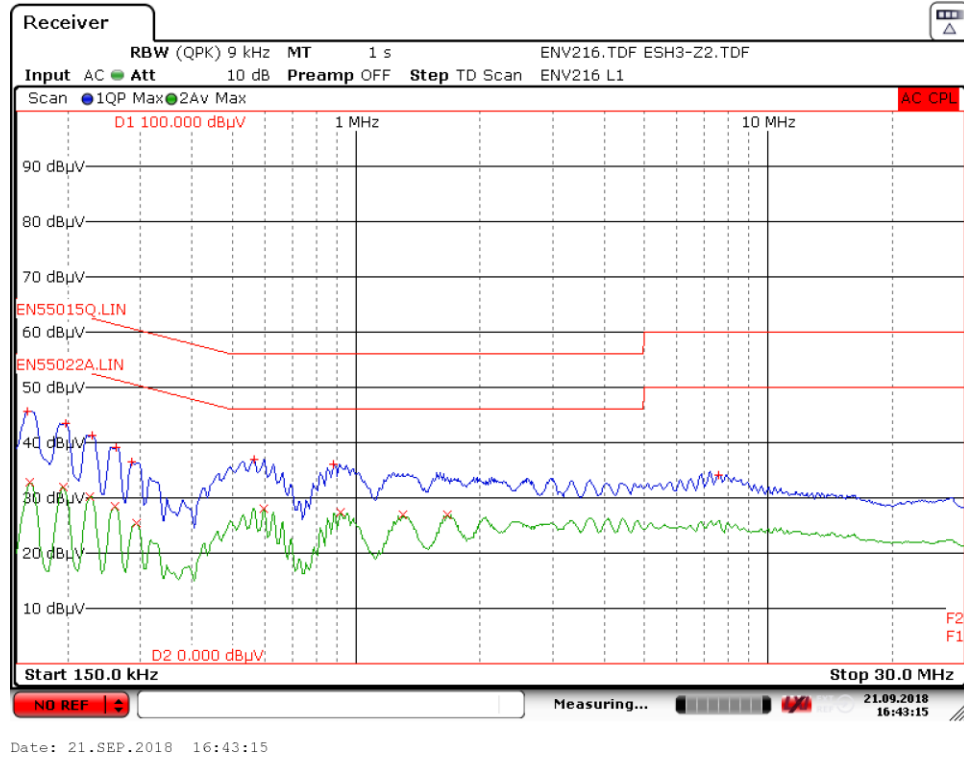


Figure 36 – Floating Ground at 115 VAC.



10.1.3 Neutral, 230 VAC

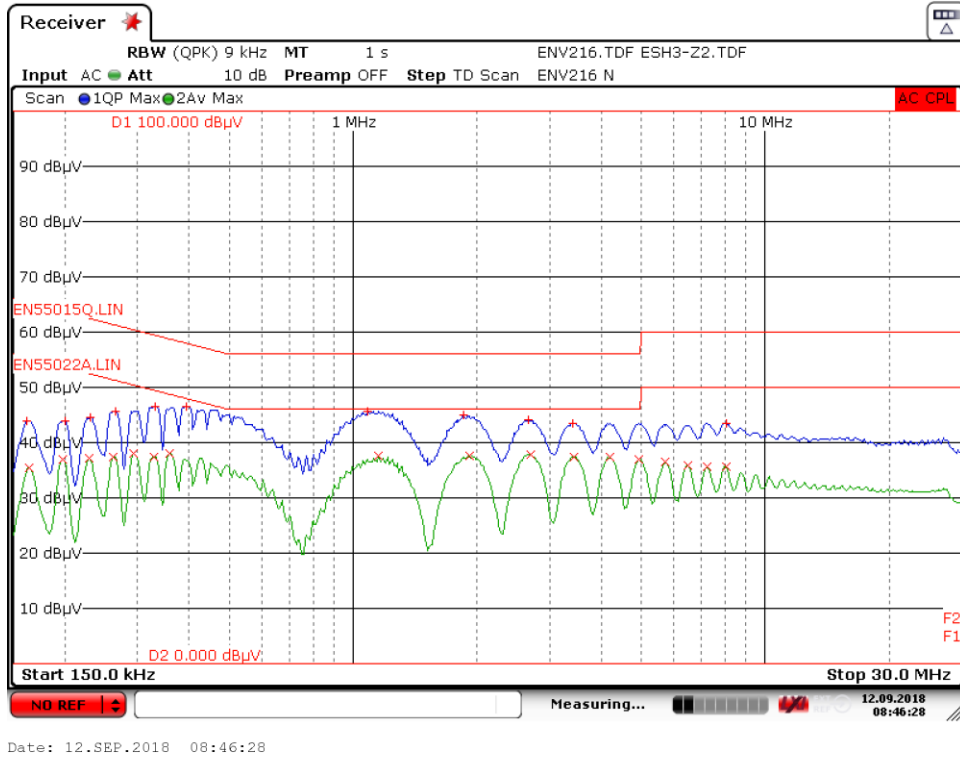


Figure 37 – Floating Ground at 230 VAC.



### 10.1.4 Neutral, 115 VAC

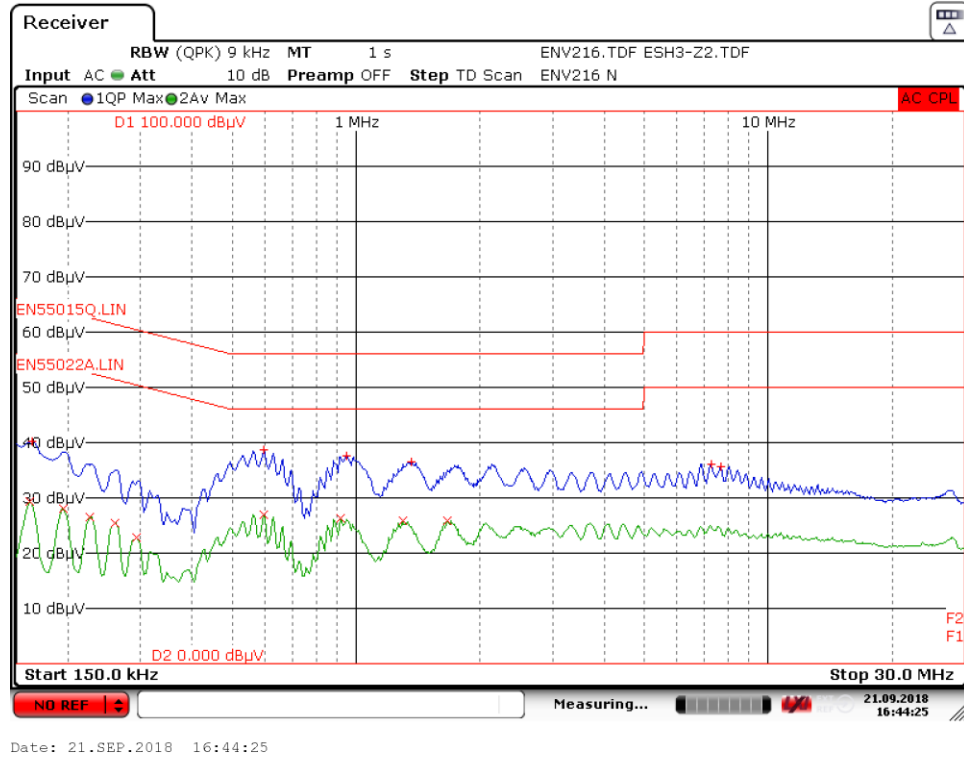


Figure 38 – Floating Ground at 115 VAC.



## 11 Lighting Surge

### 11.1 Differential Mode Test

Passed ±1 kV surge test.

Surge Voltage (kV)	Phase Angle	IEC Coupling	Generator Impedance (Ω)	Number Strikes	Result	Remarks
+1	0	L1/L2	2	10	PASS	No Auto-restart
-1	0	L1/L2	2	10	PASS	No Auto-restart
+1	90	L1/L2	2	10	PASS	No Auto-restart
-1	90	L1/L2	2	10	PASS	No Auto-restart
+1	180	L1/L2	2	10	PASS	No Auto-restart
-1	180	L1/L2	2	10	PASS	No Auto-restart
+1	270	L1/L2	2	10	PASS	No Auto-restart
-1	270	L1/L2	2	10	PASS	No Auto-restart

#### 11.1.1 1000 V 90° Differential Mode Surge

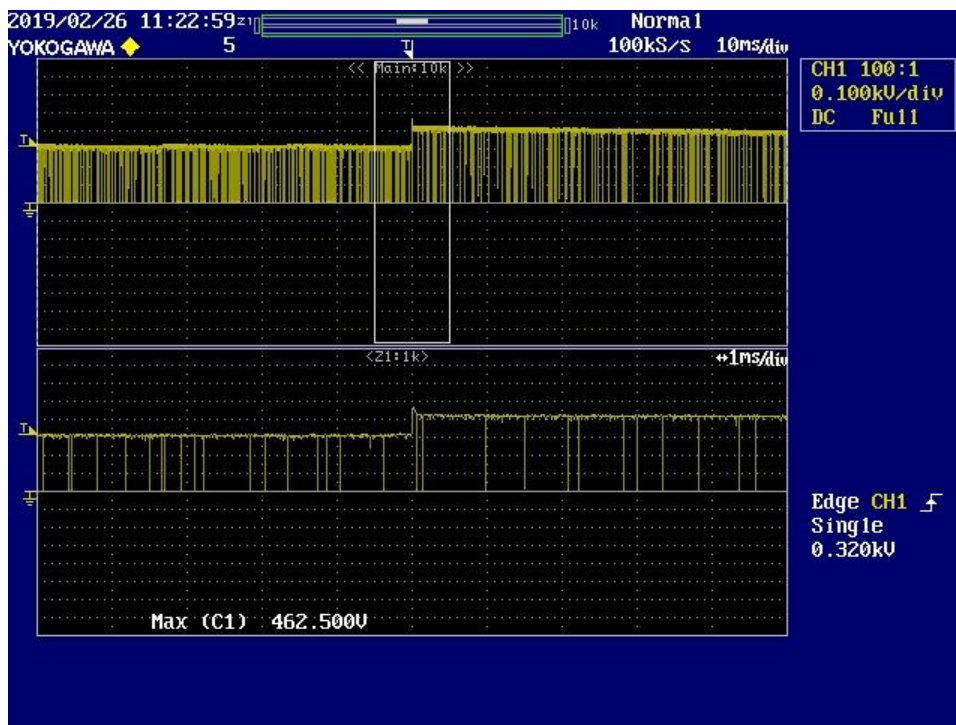


Figure 39 – Drain Voltage, 230 VAC, Full Load.

11.1.2 -1000 V 270° Differential Mode Surge



Figure 40 – Drain Voltage, 230 VAC, Full Load.



## 12 Revision History

Date	Author	Revision	Description & Changes	Reviewed
29-Apr-19	MAGM	1.0	Initial Release	Apps & Mktg
09-Jun-20	KM	1.1	Converted to RDR	Apps & Mktg



## For the latest updates, visit our website: [www.power.com](http://www.power.com)

Reference Designs are technical proposals concerning how to use Power Integrations' gate drivers in particular applications and/or with certain power modules. These proposals are "as is" and are not subject to any qualification process. The suitability, implementation and qualification are the sole responsibility of the end user. The statements, technical information and recommendations contained herein are believed to be accurate as of the date hereof. All parameters, numbers, values and other technical data included in the technical information were calculated and determined to our best knowledge in accordance with the relevant technical norms (if any). They may base on assumptions or operational conditions that do not necessarily apply in general. We exclude any representation or warranty, express or implied, in relation to the accuracy or completeness of the statements, technical information and recommendations contained herein. No responsibility is accepted for the accuracy or sufficiency of any of the statements, technical information, recommendations or opinions communicated and any liability for any direct, indirect or consequential loss or damage suffered by any person arising therefrom is expressly disclaimed.

Power Integrations reserves the right to make changes to its products at any time to improve reliability or manufacturability. Power Integrations does not assume any liability arising from the use of any device or circuit described herein. POWER INTEGRATIONS MAKES NO WARRANTY HEREIN AND SPECIFICALLY DISCLAIMS ALL WARRANTIES INCLUDING, WITHOUT LIMITATION, THE IMPLIED WARRANTIES OF MERCHANTABILITY, FITNESS FOR A PARTICULAR PURPOSE, AND NON-INFRINGEMENT OF THIRD PARTY RIGHTS.

### Patent Information

The products and applications illustrated herein (including transformer construction and circuits' external to the products) may be covered by one or more U.S. and foreign patents, or potentially by pending U.S. and foreign patent applications assigned to Power Integrations. A complete list of Power Integrations' patents may be found at [www.power.com](http://www.power.com). Power Integrations grants its customers a license under certain patent rights as set forth at <http://www.power.com/ip.htm>.

Power Integrations, the Power Integrations logo, CAPZero, ChiPhy, CHY, DPA-Switch, EcoSmart, E-Shield, eSIP, eSOP, HiperPLC, HiperPFS, HiperTFS, InnoSwitch, Innovation in Power Conversion, InSOP, LinkSwitch, LinkZero, LYTSwitch, SENZero, TinySwitch, TOPSwitch, PI, PI Expert, SCALE, SCALE-1, SCALE-2, SCALE-3 and SCALE-iDriver, are trademarks of Power Integrations, Inc. Other trademarks are property of their respective companies. ©2019, Power Integrations, Inc.

## Power Integrations Worldwide Sales Support Locations

### WORLD HEADQUARTERS

5245 Hellyer Avenue  
San Jose, CA 95138, USA.  
Main: +1-408-414-9200  
Customer Service:  
Worldwide: +1-65-635-64480  
Americas: +1-408-414-9621  
e-mail: [usasales@power.com](mailto:usasales@power.com)

### CHINA (SHANGHAI)

Rm 2410, Charity Plaza, No. 88,  
North Caoxi Road,  
Shanghai, PRC 200030  
Phone: +86-21-6354-6323  
e-mail: [chinasales@power.com](mailto:chinasales@power.com)

### CHINA (SHENZHEN)

17/F, Hivac Building, No. 2, Keji  
Nan 8th Road, Nanshan District,  
Shenzhen, China, 518057  
Phone: +86-755-8672-8689  
e-mail: [chinasales@power.com](mailto:chinasales@power.com)

### GERMANY (AC-DC/LED Sales)

Einsteinring 24  
85609 Dornach/Aschheim  
Germany  
Tel: +49-89-5527-39100  
e-mail: [eurosales@power.com](mailto:eurosales@power.com)

### GERMANY (Gate Driver Sales)

HellwegForum 1  
59469 Ense  
Germany  
Tel: +49-2938-64-39990  
e-mail: [igbt-driver.sales@power.com](mailto:igbt-driver.sales@power.com)

### INDIA

#1, 14<sup>th</sup> Main Road  
Vasanthanagar  
Bangalore-560052  
India  
Phone: +91-80-4113-8020  
e-mail: [indiasales@power.com](mailto:indiasales@power.com)

### ITALY

Via Milanese 20, 3<sup>rd</sup>. Fl.  
20099 Sesto San Giovanni (MI) Italy  
Phone: +39-024-550-8701  
e-mail: [eurosales@power.com](mailto:eurosales@power.com)

### JAPAN

Yusen Shin-Yokohama 1-chome Bldg.  
1-7-9, Shin-Yokohama, Kohoku-ku  
Yokohama-shi,  
Kanagawa 222-0033 Japan  
Phone: +81-45-471-1021  
e-mail: [japansales@power.com](mailto:japansales@power.com)

### KOREA

RM 602, 6FL  
Korea City Air Terminal B/D,  
159-6  
Samsung-Dong, Kangnam-Gu,  
Seoul, 135-728 Korea  
Phone: +82-2-2016-6610  
e-mail: [koreasales@power.com](mailto:koreasales@power.com)

### SINGAPORE

51 Newton Road,  
#19-01/05 Goldhill Plaza  
Singapore, 308900  
Phone: +65-6358-2160  
e-mail: [singaporesales@power.com](mailto:singaporesales@power.com)

### TAIWAN

5F, No. 318, Nei Hu Rd.,  
Sec. 1  
Nei Hu District  
Taipei 11493, Taiwan R.O.C.  
Phone: +886-2-2659-4570  
e-mail: [taiwansales@power.com](mailto:taiwansales@power.com)

### UK

Building 5, Suite 21  
The Westbrook Centre  
Milton Road  
Cambridge  
CB4 1YG  
Phone: +44 (0) 7823-557484  
e-mail: [eurosales@power.com](mailto:eurosales@power.com)

