

EM24



Energy analyzer for three-phase systems



Benefits

- **Time saving set-up**, by frontal joystick and selector.
- **Error-proof installation**, by self-power supply and phase sequence detection.
- **Easy variable scrolling**, by means of the front joystick.
- **Wide interfacing capability**, choosing among 2 pulse outputs, the RS485, the M-Bus, Dupline or the Ethernet communication port.
- **Extended energy measurements**, using total/partial or total/multi-tariff metering.
- **Flexible installation**, by means of the direct connection up to 65 A or the connection of 5 A current transformers.
- **Extended alarm control** on any available variable by means of up to two digital outputs.
- **Legal metrology**, guaranteed by the MID approval

Description

Three-phase energy analyzer for DIN-rail mounting with configuration joystick, frontal selector and LCD display. Direct connection up to 65A or via current and voltage transformers. It can be equipped with 2 digital outputs (pulse transmission or alarm function). In alternative the Modbus RTU or Dupline communication port and 3 digital inputs, the M-Bus communication, or the Modbus TCP/IP Ethernet ports are available.

Applications

EM24 is perfect solution in any application, specially in building and industrial automation, for cost allocation, and for energy efficiency monitoring, legal submetering in commercial and residential installations, and wherever energy and main electrical variables monitoring is required.

EM24 is particularly suited for:

- energy efficiency monitoring
- cost allocation
- fiscal/legal sub-billing

Main functions

- Measurement of energy consumption and main electrical variables of single-phase, two-phase or three-phase loads.
- Display of single phase measurements and total measurements.
- Transmission of data via serial communication (Modbus RTU, M-Bus or Dupline) or Ethernet (Modbus TCP/IP).
- Transmission of power consumption via pulse output (optional).
- Easy connection function

Main features

- Energy measurements: total and partial kWh and kvarh or based on 4 different tariffs; single phase measurements
- Gas, cold water, hot water, kWh remote heating measurements
- TRMS measurements of distorted sine waves (voltages/currents)

Structure

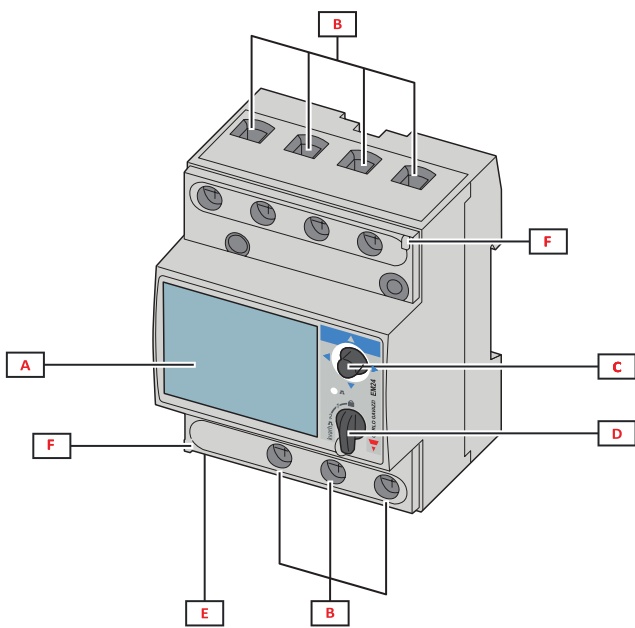

Fig. 1 Direct connection

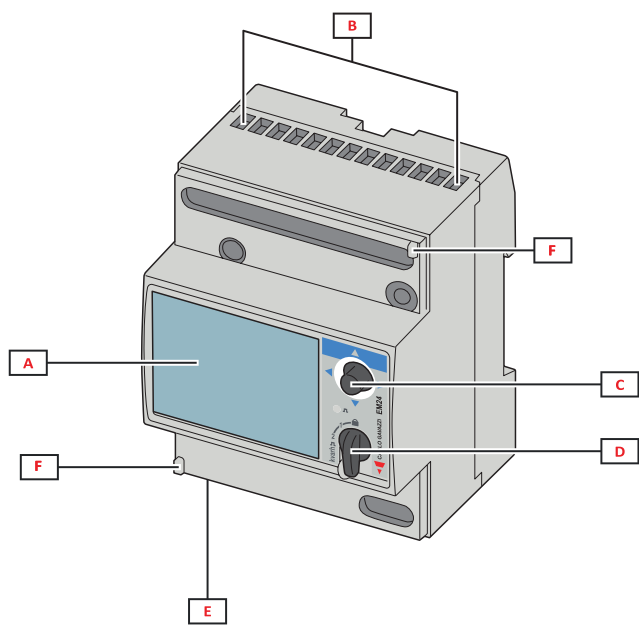

Fig. 2 CT connection

Area	Description
A	LCD display
B	Voltage/current connections
C	Joystick
D	Selector with pin for MID seal (programming block)
E	Inputs/outputs or communication port
F	Pins for MID seal (protection covers included)

Features

General

Protection degree	Front: IP50. Terminals: IP20
Terminals	Screw terminals AV2, AV9: Max.: 16 mm ² , min.: 2.5 mm ² (by cable lug) AV5, AV6: Max.: 1.5 mm ²
Overvoltage category	Cat. III
Pollution degree	2
Noise rejection (CMRR)	100 dB, from 42 to 62 Hz
Mounting	DIN rail
Weight	400 g (packaging included)

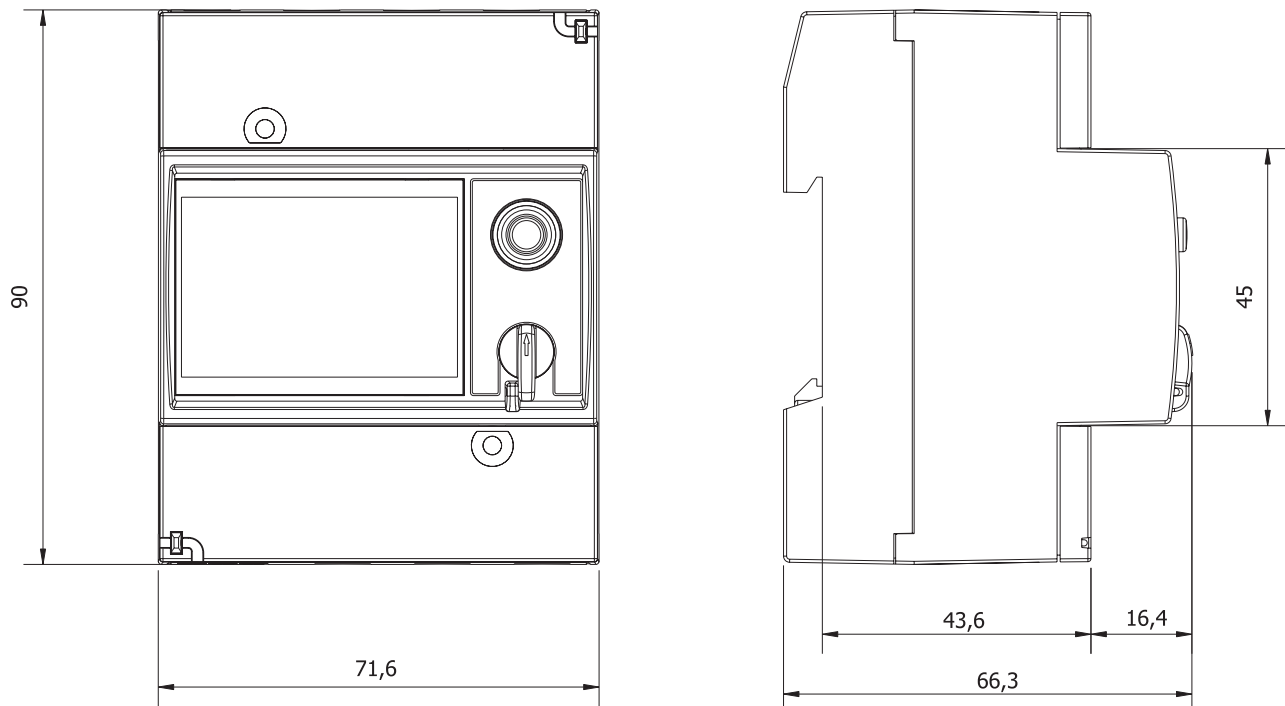

Environmental specifications



Operating temperature	From -25 to +55 °C/from -13 to +131 °F
Storage temperature	From -30 to +70 °C/from -22 to +158 °F

NOTE: R.H. < 90 % non-condensing @ 40 °C / 104 °F.

Input and output insulation

Type	Measuring inputs	Relay outputs	Open collector outputs	Communication port and digital inputs	Dupline	Ethernet port	Self power supply	Auxiliary power supply
Measuring inputs	-	4 kV	4 kV	4 kV	4 kV	4 kV	0 kV	4 kV
Relay outputs	4 kV	-	-	-	-	-	4 kV	4 kV
Open collector outputs	4 kV	-	-	-	-	-	4 kV	4 kV
Communication port and digital inputs	4 kV	-	-	-	-	-	4 kV	4 kV
Dupline	4 kV	-	-	-	-	-	4 kV	4 kV
Ethernet port	4 kV	-	-	-	-	-	4 kV	-
Self power supply	0 kV	4 kV	4 kV	4 kV	4 kV	4 kV	-	-
Auxiliary power supply	4 kV	4 kV	4 kV	4 kV	4 kV	-	-	-

Compatibility and conformity

Directives	2011/65/EU (RoHs)
Standards	Electromagnetic compatibility (EMC) - emissions and immunity: EN 62052-11 Electrical safety: EN 61010-1, EN 50470-1 (MID) Accuracy: EN 62053-21, EN 62053-23, EN 50470-3 (MID) Pulse outputs: IEC 62053-31, DIN 43864
Approvals	  (AV5, AV6 only, except M2) MID (PF only)

Electrical specifications

Voltage - MID models				
Voltage inputs	AV2	AV9	AV5	AV6
Voltage connection	Direct			
Rated voltage L-N (from Un min to Un max)	133 to 230 V	230 V	230 V	57.7 to 120 V
Rated voltage L-L (from Un min to Un max)	230 to 400 V	400 V	400 V	100 to 208 V
Voltage tolerance (*)	-20%, +15%			
Overload (**)	Continuous: 1.15 Un max			
Input impedance	Refer to "Power supply"			
Frequency	50 Hz			

Voltage - Non MID models (according to IEC 62052-11)					
Voltage inputs		AV2	AV9	AV5	AV6
Voltage connection		Direct			Direct or via VT
Rated voltage L-N (from Un min to Un max)	All models except E1:	133 to 230 V	230 V	230 V	57.7 to 120V
	E1 model:	120 to 277 V	/	120 to 277 V	/
Rated voltage L-L (from Un min to Un max)	All models except E1:	230 to 400 V	400 V	400 V	100 to 208 V
	E1 model:	208 to 480 V	/	208 to 480 V	/
Voltage tolerance (*)		-20%, +15%			
Overload (**)		Continuous: 1.15 (Un max)		Continuous: 1.2 (Un max)	
Input impedance		Refer to "Power supply"		>1600 kΩ	
Frequency		50/60 Hz			

Voltage - Non MID models (according to UL 508)					
Voltage inputs		AV2	AV9	AV5	AV6
Voltage connection		Direct			Direct or via VT
Rated voltage L-N (from Un min to Un max) All models except E1, M2		/	/	230 to 346 V	57.7 to 144 V
Rated voltage L-L (from Un min to Un max) All models except E1, M2		/	/	400 to 600 V	100 to 250 V
Voltage tolerance (*)		-20%, +15%			
Overload (**)		Continuous: 1.15 (Un max)			
Input impedance		Refer to "Power supply"		>1600 kΩ	
Frequency		50/60 Hz			

(*) reference range for stated accuracy

(**) max reference for no instrument damage

Current					
Current inputs		AV2	AV9	AV5	AV6
Current connection		Direct		Via CT	
Rated current (In)		-		5 A	
Base current (Ib)		10 A		-	
Minimum current (Imin)		0.5 A		0.05 A	
Maximum current (Imax)		65 A		10 A	
Start-up current (Ist)		0.04 A		0.01 A	
Overload		Continuous: 65 A @50 Hz For 10 ms: 1950 A @ 50 Hz		Continuous: 10 A @50 Hz For 500 ms: 200 A @ 50 Hz	
Input impedance		< 1.7 VA		< 0.7 VA	
Crest factor		4 (Imax peak 92 A)		3 (Imax peak 15 A)	

Maximum CTxVT ratio					
Current inputs		AV2	AV9	AV5	AV6
Non-MID models except E1		-	-	4629	14529
Non-MID E1 model		-	-	6975	-
MID models		-	-	3150	-

Power supply

Non MID models				
	AV2	AV9	AV5	AV6
Type	Self power supply		D: 115/230 V ac, +/-15%, 50/60Hz L: 24 to 48 V ac/dc; ac: +/-15%, 50/60Hz, dc: +/-20% X (E1 only): Self power supply	
Consumption	IS and DP: < 12VA/2W E1: 4.7VA/< 2.9W Others: < 20VA/1W		D: < 2.5VA/1.5W L: < 2.5VA/1W	

MID models				
	AV2	AV9	AV5	AV6
Type	Self power supply			
Consumption	IS and DP: < 12VA/2W E1: < 4.7VA/2.9 W Others: < 20VA/1W		<4.5VA/2.9W E1: < 4.7VA/2.9 W	

Measurements

Method	TRMS measurements of distorted waveforms
Sampling	1600 samples/s @50 Hz 1900 samples/s @60 Hz

Available measurements

Active energy	Unit	System	Phase	Note
Imported (+) Total	kWh+	●	●	
Imported (+) partial	kWh+	●	-	
Exported (-) Total	kWh-	●	-	
Imported (+) by tariff	kWh+	●	-	T1, T2, T3, T4

Reactive energy	Unit	System	Phase
Imported (+) Total	kvarh+	●	-
Imported (+) partial	kvarh+	●	-
Exported (-) Total	kvarh-	●	-
Imported (+) by tariff	kvarh+	●	-

Electrical variable	Unit	System	Phase
Voltage L-N	V	•	•
Voltage L-L	V	•	•
Current	A	-	•
DMD MAX	A	•	-
Active power	kW	•	•
DMD	kW	•	-
DMD MAX	kW	•	-
Apparent power	kVA	•	•
DMD	kVA	•	-
DMD MAX	kVA	•	-
Reactive power	kvar	•	•
Power factor	PF	•	•
Frequency	Hz	•	-
Run hour meter	h	•	-

Measurement accuracy

Current	AV2	AV9	AV5	AV6
From 0.5 A to 2 A	±(0.5% rdg + 3dgt)		-	-
From 2 A to 65 A	±(0.5% rdg + 1dgt)		-	-
From 0.05 A to 1 A	-	-	±(0.5% rdg + 3dgt)	
From 1 A to 10 A	-	-	±(0.5% rdg + 1dgt)	

Phase-phase voltage	AV2	AV9	AV5	AV6
In the range U_n	±(1% rdg + 1dgt)			

Phase-neutral voltage	AV2	AV9	AV5	AV6
In the range U_n	±(0.5% rdg + 1dgt)			

Active and apparent power	AV2	AV9	AV5	AV6
From 1.0 A to 65.0 A (PF=0.5L, 1, 0.8C)	±(1% rdg + 1dgt)		-	
From 0.5 A to 1.0 A (PF=1)	±(1.5% rdg + 1dgt)		-	
From 0.25 A to 10 A (PF=0.5L, 1, 0.8C)	-		±(1% rdg + 1dgt)	
From 0.05 A to 0.25 A (PF=1)	-		±(1.5% rdg + 1dgt)	

Reactive power	AV2	AV9	AV5	AV6
From 1.0 A to 2.0 A ($\sin\phi=0.5L$, 0.5C)	±(2.5% rdg + 1 dgt)		-	
From 0.5 A to 1.0 A ($\sin\phi=1$)				
From 2.0 A to 65.0 A ($\sin\phi=0.5L$, 0.5C)	±(2% rdg + 1 dgt)		-	
From 1.0 A to 65.0 A ($\sin\phi=1$)				
From 0.25 A to 0.5 A ($\sin\phi=0.5L$, 0.5C)	-		±(2.5% rdg + 1 dgt)	
From 0.1 A to 0.25 A ($\sin\phi=1$)				
From 0.5 A to 10 A ($\sin\phi=0.5L$, 0.5C)	-		±(2% rdg + 1 dgt)	
From 0.25 A to 10 A ($\sin\phi=1$)				
Active energy	Class 1 (EN62053-21) Class B (EN50470-3) (MID)			
Reactive energy	Class 2 (EN62053-23)			

Frequency	
From 45 to 65 Hz	±0.1 Hz

Display

Type	LCD
Refresh time	< 750 ms
Description	3 rows: 1 st : 8 digits (7 mm) 2 nd : 4 digits (7 mm) 3 rd : 4 digits (7 mm)
Variable readout	Instantaneous: 4 digits, min: 0.000, max: 9999 Energy: 8 digits (imported), 7 digits (exported), min: 0.00, max: 99 999 999

LED

Model	CT*VT	Weight (kWh per pulse)
AV5/AV6	≤ 7	0.001
	> 7 ≤ 70.0	0.01
	> 70 ≤ 700.0	0.1
	> 700	1
AV2/AV9	N/A	0.001

Digital outputs/inputs

Digital outputs: static output (O2)

Connection type	Screw terminals
Maximum number of outputs	2
Type	Open collector
Function	Pulse output or alarm output
Features	V _{ON} 1.2 V dc, max. 100 mA V _{OFF} 30 V dc max
Configuration parameters	Output function (pulse/alarm) Output normal status Pulse weight (0.001 to 10 kWh/pulse or kvarh/pulse) Pulse duration (30 or 100 ms) Linked variable Alarm delay
Configuration mode	Via keypad

Digital outputs: relay output (R2)

Connection type	Screw terminals
Maximum number of outputs	2
Type	relay (SPST)
Function	Pulse output or alarm output
Features	AC-1: 5 A@250 V ac DC-12: 5 A@24 V dc AC-15: 1.5 A @ 250 V ac DC-13: 1.5 A @ 24 V dc
Configuration parameters	Output function (pulse/alarm) Output normal status Pulse weight (0.001 to 10 kWh/pulse or kvarh/pulse) Pulse duration (30 or 100 ms) Linked variable Alarm delay
Configuration mode	Via keypad

Digital inputs (IS, DP)

Number of inputs	3
Functions	Remote status DMD synchronization Pulse counting Tariff management
Frequency	20Hz max, duty cycle 50%
Pulse weight	From 0.001 to 999.9 m3 or kWh per pulse
Contact measuring voltage	5 V dc +/- 5%
Contact measuring current	10 mA max
Input impedance	680Ω
Open contact resistance	≥500 kΩ
Closed contact voltage	≤100 Ω
Configuration parameters	Input function Pulse weight
Configuration mode	Via joystick or UCS software (IS)

Communication ports

RS485 port (IS)

Protocol	Modbus RTU
Devices on the same bus	Max 160 (1/5 unit load)
Communication type	Multidrop, bidirectional
Connection type	2 wires
Configuration parameters	Modbus address (from 1 to 247) Baud rate (4.6/9.6 kbps) 1 stop bit, no parity
Refresh time	< 750 ms
Configuration mode	Via keypad or UCS software

M-Bus (M1, M2)

Protocol	M1: M-Bus according to EN13757-3:2005 M2: M-Bus according to EN13757-3:2013
Driver input capability	1 unit load
Communication type	One-drop, directional
Connection type	2 wires
Configuration parameters	Primary address (1 to 247) Baud rate (0.3/ 2.4 / 9.6 kbps)
Configuration mode	Via keypad

Ethernet port (E1)

Protocols	Modbus TCP/IP
Client connections	Maximum 5 simultaneously
Connection type	RJ45 connector (10 Base-T, 100 Base-TX), maximum distance 100 m
Configuration parameters	IP address Subnet mask Gateway TCP/IP port DHCP enabling
Configuration mode	Via keypad or UCS software

Dupline port (DP)

Protocol	Dupline
Connection type	2 wires
Dupline data format	3 1/2 dgt BCD
Full scale value	selectable from 1.999 to 1999 M
Used channels	depending on the number of variables
Multiplexer	A1 to A4 G1 to H8 (1st group of 16 variables) I1 to J8 (2nd group of 16 variables) K1 to L8 (3th group of 16 variables) M1 to N8 (4th group of 16 variables) O1 to P8 (5th group of 16 variables)
Available variables	all, except for the "max" variables
Configuration parameters	Dupline inputs Dupline counters Dupline analogue variables Dupline output
Configuration mode	Via keypad

Counters	
Function	Multiplexer for counter values
Number of counters	6 per instrument, 128 per network
Counter range	0... 99 999 999
Used channels	B to F
Multiplexer	B2 to B8
Reset	B1
Value	C1 to F8
Counter reset	enable/disable function for all the counters
Available counters	kWh tot, -kWh tot, kvarh tot, -kvarh tot, kWh t1, kWh t2, kWh L1, kWh L2, kWh L3, counter dig. in. 1, counter dig. in. 2, counter dig. in. 3, Run hour meter

Input (synchro/tariff)	
Function	Monostable (push-button), realtime
Used channels	A5
Working mode	selectable: <ul style="list-style-type: none"> • none • Wdmd synchronization • total and partial energy meter (kWh, kvarh) managed by time periods (t1-t2).

Outputs (alarms)	
Function	monostable (push-button)
Used channels	selectable (A1 to P8). No control that the selected channels are not used for counters or analog variables
Number of alarms	2 per instrument
Alarm modes	up alarm, down alarm
Set-point adjustment	from 0 to 100% of the display scale
Hysteresis	from 0 to full scale
On-time delay	0 to 255 s
Output status	normally energised
Available variables	all, except for the "max" variables

Analogue variables	
Function	Multiplexer for analogue values
Number of variables	8 per instrument, 80 per network

Connection Diagrams

Three-phase with neutral (4-wire)

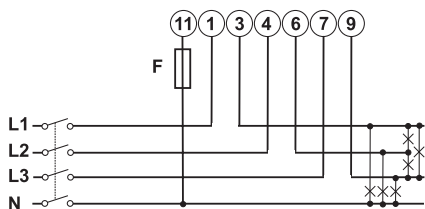

Fig. 3 AV2, AV9

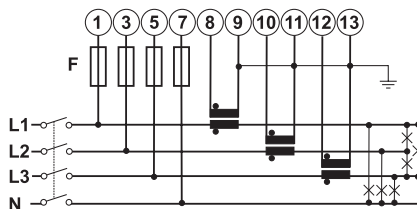

Fig. 4 AV5, AV6

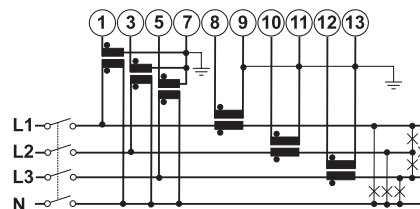

Fig. 5 AV6

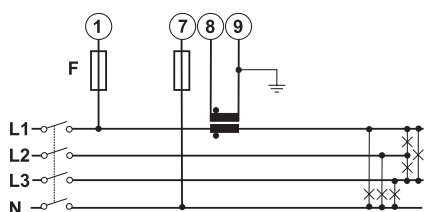

Fig. 6 AV5, AV6 balanced load

Three-phase without neutral (3-wire)

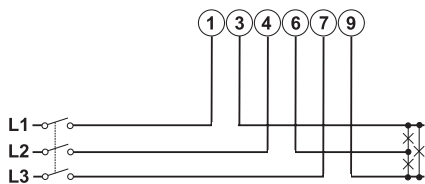

Fig. 7 AV2, AV9 (except IS, R2)

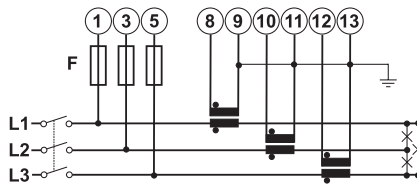

Fig. 8 AV5, AV6

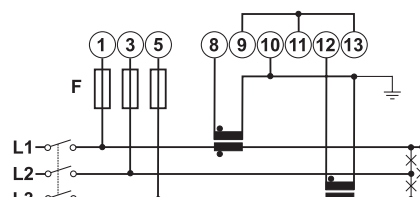

Fig. 9 AV5, AV6

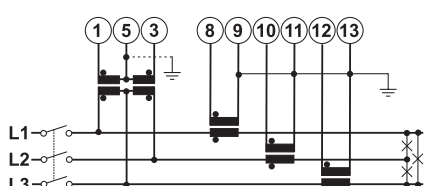

Fig. 10 AV6

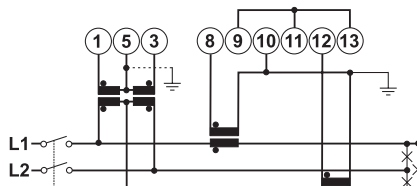

Fig. 11 AV6

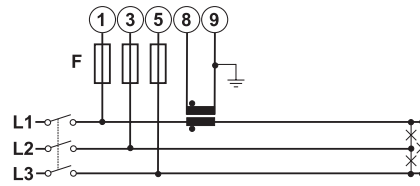

Fig. 12 AV5, AV6 balanced load

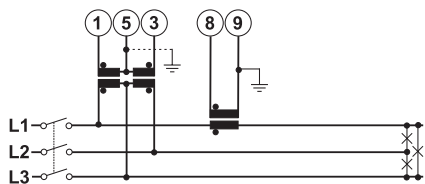

Fig. 13 AV6 balanced load



Two-phase system with neutral (3-wire)

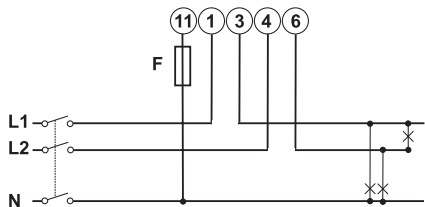

Fig. 14 AV2, AV9

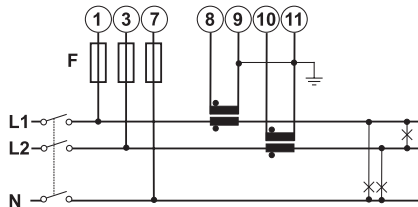

Fig. 15 AV5, AV6

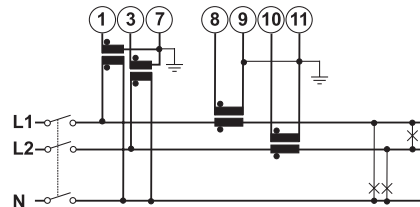

Fig. 16 AV6

Single-phase (2-wire)

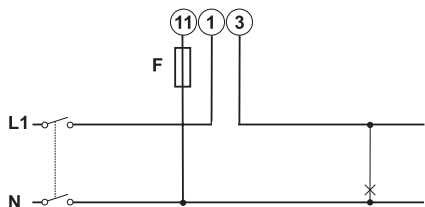

Fig. 17 AV2, AV9 (except IS, R2)

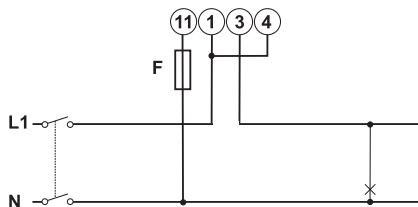

Fig. 18 AV2, AV9 (IS, R2)

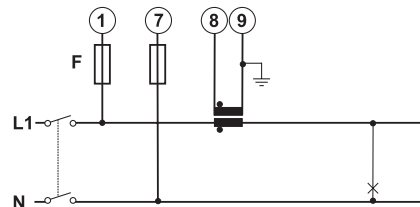

Fig. 19 AV5, AV6

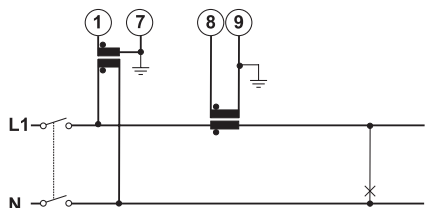

Fig. 20 AV6

Power supply

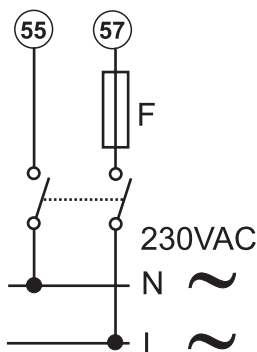

Fig. 21 D option. F = 250 V, 50 mA

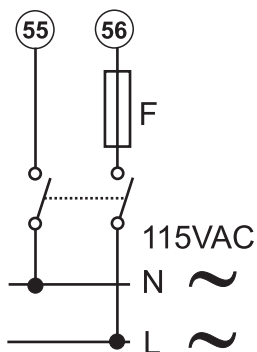

Fig. 22 D option. F = 250 V, 100 mA

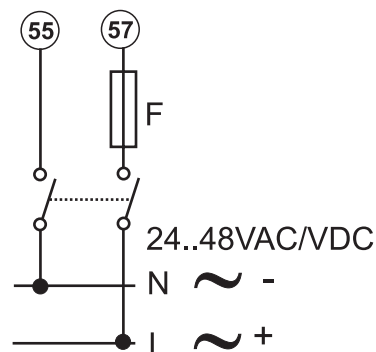

Fig. 23 L option. F = 250 V, 200 mA

Static outputs and relay outputs

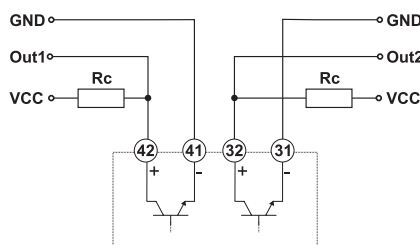

Fig. 24 Static outputs, GND reference

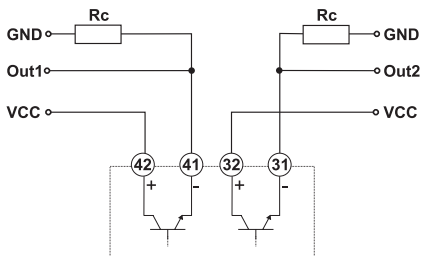

Fig. 25 Static outputs, VCC reference

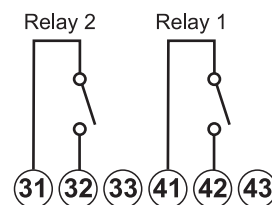

Fig. 26 Relay outputs

Digital inputs, RS485 and Dupline ports

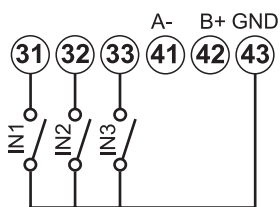

Fig. 27 Digital inputs

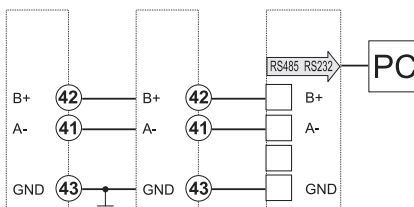

Fig. 28 RS485 port

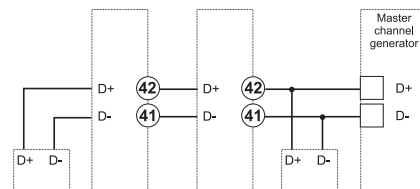
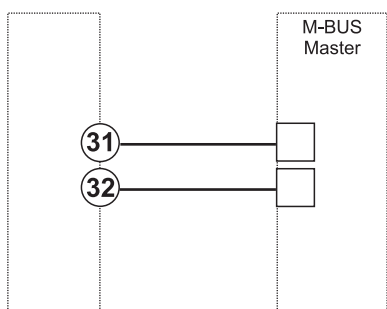

Fig. 29 Dupline port

M-Bus



MID connection diagrams

Three-phase with neutral (4-wire)

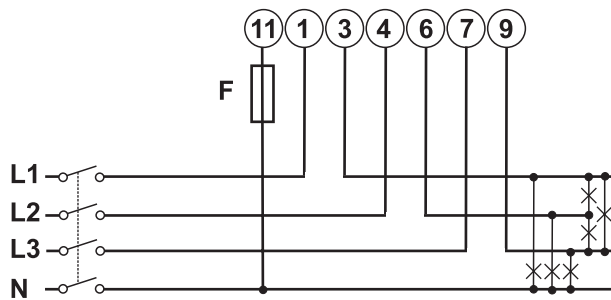

Fig. 30 AV2, AV9

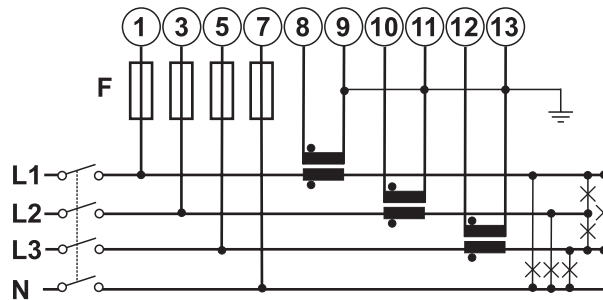

Fig. 31 AV5, AV6

References

Order code

Non MID models

Component name/part number	I/O communication	Voltage inputs	Current inputs	Power supply
EM24DIN AV5 3D XX X	none	230V L-N 400V L-L	5(10) A via CT	115/230 V ac
EM24DIN AV9 3X XX X	none	230V L-N 400V L-L	10 (65) A	Self power supply

Component name/part number	I/O communication	Voltage inputs	Current inputs	Power supply
EM24DIN AV5 3D R2 X	2 relay outputs	230V L-N 400V L-L	5(10) A via CT	115/230 V ac
EM24DIN AV9 3X R2 X	2 relay outputs	230V L-N 400V L-L	10 (65) A	Self power supply

Component name/part number	I/O communication	Voltage inputs	Current inputs	Power supply
EM24DIN AV5 3D O2 X	2 static outputs	230V L-N 400V L-L	5(10) A via CT	115/230 V ac
EM24DIN AV5 3L O2 X	2 static outputs	230V L-N 400V L-L	10 (65) A	From 24 to 48 V ac/dc
EM24DIN AV6 3D O2 X	2 static outputs	From 57.7 to 120 V L-N From 100 to 208 V L-L	5(10) A via CT	115/230 V ac
EM24DIN AV6 3L O2 X	2 static outputs	From 57.7 to 120 V L-N From 100 to 208 V L-L	5(10) A via CT	From 24 to 48 V ac/dc
EM24DIN AV2 3X O2 X	2 static outputs	From 133 to 230 V L-N From 230 to 400 V L-L	10 (65) A	Self power supply
EM24DIN AV9 3X O2 X	2 static outputs	230V L-N 400V L-L	10 (65) A	Self power supply



Component name/part number	I/O communication	Voltage inputs	Current inputs	Power supply
EM24DIN AV5 3D DP X	3 digital inputs + Dupline	230V L-N 400V L-L	5(10) A via CT	115/230 V ac
EM24DIN AV5 3L DP X	3 digital inputs + Dupline	230V L-N 400V L-L	5(10) A via CT	From 24 to 48 V ac/dc
EM24DIN AV6 3D DP X	3 digital inputs + Dupline	From 57.7 to 120 V L-N From 100 to 208 V L-L	5(10) A via CT	115/230 V ac
EM24DIN AV6 3L DP X	3 digital inputs + Dupline	From 57.7 to 120 V L-N From 100 to 208 V L-L	5(10) A via CT	From 24 to 48 V ac/dc
EM24DIN AV2 3X DP X	3 digital inputs + Dupline	From 133 to 230 V L-N From 230 to 400 V L-L	10 (65) A	Self power supply
EM24DIN AV9 3X DP X	3 digital inputs + Dupline	230V L-N 400V L-L	10 (65) A	Self power supply

Component name/part number	I/O communication	Voltage inputs	Current inputs	Power supply
EM24DIN AV5 3D IS X	3 digital inputs + RS485 Modbus RTU	230V L-N 400V L-L	5(10) A via CT	115/230 V ac
EM24DIN AV5 3L IS X	3 digital inputs + RS485 Modbus RTU	230V L-N 400V L-L	5(10) A via CT	From 24 to 48 V ac/dc
EM24DIN AV6 3D IS X	3 digital inputs + RS485 Modbus RTU	From 57.7 to 120 V L-N From 100 to 208 V L-L	5(10) A via CT	115/230 V ac
EM24DIN AV6 3L IS X	3 digital inputs + RS485 Modbus RTU	From 57.7 to 120 V L-N From 100 to 208 V L-L	5(10) A via CT	From 24 to 48 V ac/dc
EM24DIN AV2 3X IS X	3 digital inputs + RS485 Modbus RTU	From 133 to 230 V L-N From 230 to 400 V L-L	10 (65) A	Self power supply
EM24DIN AV9 3X IS X	3 digital inputs + RS485 Modbus RTU	230V L-N 400V L-L	10 (65) A	Self power supply

Component name/part number	I/O communication	Voltage inputs	Current inputs	Power supply
EM24DIN AV5 3X E1 X	Ethernet Modbus TCP/IP	From 120 to 277 V L-N From 208 to 480 V L-L	5(10) A via CT	Self power supply
EM24DIN AV2 3X E1 X	Ethernet Modbus TCP/IP	From 120 to 277 V L-N From 208 to 480 V L-L	10 (65) A	Self power supply



Component name/part number	I/O communication	Voltage inputs	Current inputs	Power supply
EM24DIN AV5 3D M1 X	M-Bus according to EN 13757-3 (2005)	230V L-N 400V L-L	5(10) A via CT	115/230 V ac
EM24DIN AV5 3L M1 X	M-Bus according to EN 13757-3 (2005)	230V L-N 400V L-L	5(10) A via CT	From 24 to 48 V ac/dc
EM24DIN AV6 3D M1 X	M-Bus according to EN 13757-3 (2005)	From 57.7 to 120 V L-N From 100 to 208 V L-L	5(10) A via CT	115/230 V ac
EM24DIN AV6 3L M1 X	M-Bus according to EN 13757-3 (2005)	From 57.7 to 120 V L-N From 100 to 208 V L-L	5(10) A via CT	From 24 to 48 V ac/dc
EM24DIN AV2 3X M1 X	M-Bus according to EN 13757-3 (2005)	From 133 to 230 V L-N From 230 to 400 V L-L	10 (65) A	Self power supply
EM24DIN AV9 3X M1 X	M-Bus according to EN 13757-3 (2005)	230V L-N 400V L-L	10 (65) A	Self power supply

Component name/part number	I/O communication	Voltage inputs	Current inputs	Power supply
EM24DIN AV5 3D M2 X	M-Bus according to EN 13757-3 (2013)	230V L-N 400V L-L	5(10) A via CT	115/230 V ac
EM24DIN AV5 3L M2 X	M-Bus according to EN 13757-3 (2013)	230V L-N 400V L-L	5(10) A via CT	From 24 to 48 V ac/dc
EM24DIN AV6 3D M2 X	M-Bus according to EN 13757-3 (2013)	From 57.7 to 120 V L-N From 100 to 208 V L-L	5(10) A via CT	115/230 V ac
EM24DIN AV6 3L M2 X	M-Bus according to EN 13757-3 (2013)	From 57.7 to 120 V L-N From 100 to 208 V L-L	5(10) A via CT	From 24 to 48 V ac/dc
EM24DIN AV2 3X M2 X	M-Bus according to EN 13757-3 (2013)	From 133 to 230 V L-N From 230 to 400 V L-L	10 (65) A	Self power supply
EM24DIN AV2 3X M2 X	M-Bus according to EN 13757-3 (2013)	230V L-N 400V L-L	10 (65) A	Self power supply

MID models

Component name/part number	I/O communication	Voltage inputs	Current inputs	Power supply
EM24DIN AV5 3X XX PFA EM24DIN AV5 3X XX PFB	none	230V L-N 400V L-L	5(10) A via CT	Self power supply
EM24DIN AV2 3X XX PFA EM24DIN AV2 3X XX PFB	none	230V L-N 400V L-L	10 (65) A	Self power supply
EM24DIN AV9 3X XX PFA EM24DIN AV9 3X XX PFB	none	230V L-N 400V L-L	10 (65) A	Self power supply

Component name/part number	I/O communication	Voltage inputs	Current inputs	Power supply
EM24DIN AV5 3X O2 PFA EM24DIN AV5 3X O2 PFB	2 static outputs	230V L-N 400V L-L	5(10) A via CT	Self power supply
EM24DIN AV2 3X O2 PFA EM24DIN AV2 3X O2 PFB	2 static outputs	230V L-N 400V L-L	10 (65) A	Self power supply
EM24DIN AV9 3X O2 PFA EM24DIN AV9 3X O2 PFB	2 static outputs	230V L-N 400V L-L	10 (65) A	Self power supply

Component name/part number	I/O communication	Voltage inputs	Current inputs	Power supply
EM24DIN AV5 3X DP PFA EM24DIN AV5 3X DP PFB	3 digital inputs + Dupline	230V L-N 400V L-L	5(10) A via CT	Self power supply
EM24DIN AV2 3X DP PFA EM24DIN AV2 3X DP PFB	3 digital inputs + Dupline	230V L-N 400V L-L	10 (65) A	Self power supply

Component name/part number	I/O communication	Voltage inputs	Current inputs	Power supply
EM24DIN AV5 3X IS PFA EM24DIN AV5 3X IS PFB	3 digital inputs + RS485 Modbus RTU	230V L-N 400V L-L	5(10) A via CT	Self power supply
EM24DIN AV2 3X IS PFA EM24DIN AV2 3X IS PFB	3 digital inputs + RS485 Modbus RTU	230V L-N 400V L-L	10 (65) A	Self power supply
EM24DIN AV9 3X IS PFA EM24DIN AV9 3X IS PFB	3 digital inputs + RS485 Modbus RTU	230V L-N 400V L-L	10 (65) A	Self power supply

Component name/part number	I/O communication	Voltage inputs	Current inputs	Power supply
EM24DIN AV5 3X E1 PFA EM24DIN AV5 3X E1 PFB	Ethernet Modbus TCP/IP	230V L-N 400V L-L	5(10) A via CT	Self power supply
EM24DIN AV2 3X E1 PFA EM24DIN AV2 3X E1 PFB	Ethernet Modbus TCP/IP	230V L-N 400V L-L	10(65) A	Self power supply

Component name/part number	I/O communication	Voltage inputs	Current inputs	Power supply
EM24DIN AV5 3X M1 PFA EM24DIN AV5 3X M1 PFB	M-Bus according to EN 13757-3 (2005)	230V L-N 400V L-L	5(10) A via CT	Self power supply
EM24DIN AV2 3X M1 PFA EM24DIN AV2 3X M1 PFB	M-Bus according to EN 13757-3 (2005)	230V L-N 400V L-L	10(65) A	Self power supply

Further reading

Information	Where to find it
User manual - E1	www.productselection.net/MANUALS/UK/em24_E1_im_use.pdf
Installation instruction - E1	www.productselection.net/MANUALS/UK/em24_E1_im_inst.pdf
Instruction manual - M2	www.productselection.net/MANUALS/UK/em24M2_im.pdf
Instruction manual - other versions	www.productselection.net/MANUALS/UK/em24_im.pdf
Instruction manual - other versions MID	www.productselection.net/MANUALS/UK/em24_mid_im.pdf

CARLO GAVAZZI compatible components

Purpose	Component name/part number	Notes
Monitor data from several analyzers	VMU-C	See relevant datasheet

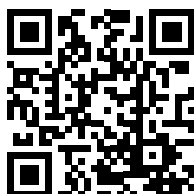

COPYRIGHT ©2018
Content subject to change. Download the PDF: www.productselection.net