



Product designation	Modular switching power supplies		
Product type designation	PSL1M		
Input characteristics			
Input type	Single-phase		
Rated supply voltage AC	VAC	Multivoltage 100...240	
Operating range			
AC	min	VAC	90
	Max	VAC	264
DC	min	VDC	120
	Max	VDC	375
Rated frequency		Hz	50/60
Operational frequency	min	Hz	47
	max	Hz	63
Current consumption Max		mA	900
PFC	No		
Insulation voltage Input/Output	AC	VAC	3000
	DC	VAC	4242
Internal fuse (250VAC)	T2A 250VAC		
Output characteristics			
Rated output voltage DC		VDC	12
Voltage trimming (potentiometer) DC	min	VDC	12
	Max	VDC	14
Rated output current		A	2.75
Rated output power		W	33
Temperature coefficient		%/°C	±0.03
Line adjustment		%	±1
Load adjustment		%	±1
Efficiency		%	83
Overload protection	110...150%		
Short-circuit protection	Fold forward		
Ripple & noise		mV	50
Parallel connection		Nr.	No
Indications			
LED indicator for power on	Yes		
LED indicator for low voltage	Yes		
Connections			
Terminals type	Screw		
Ambient conditions			

Temperature

Operating temperature

min	°C	-40
max	°C	+71

Storage temperature

min	°C	-40
max	°C	+85

Derating

%/°C	2.5%/°C above 56°C
------	--------------------

Housing

Execution (n° of modules)

3

Material

Plastic

IEC degree of protection

IP20

Dimensions (W x H x D)

mm 53 x 96 x 56.2

Weight

g 248

Installations

Mounting

On 35mm DIN rail

Dimensions

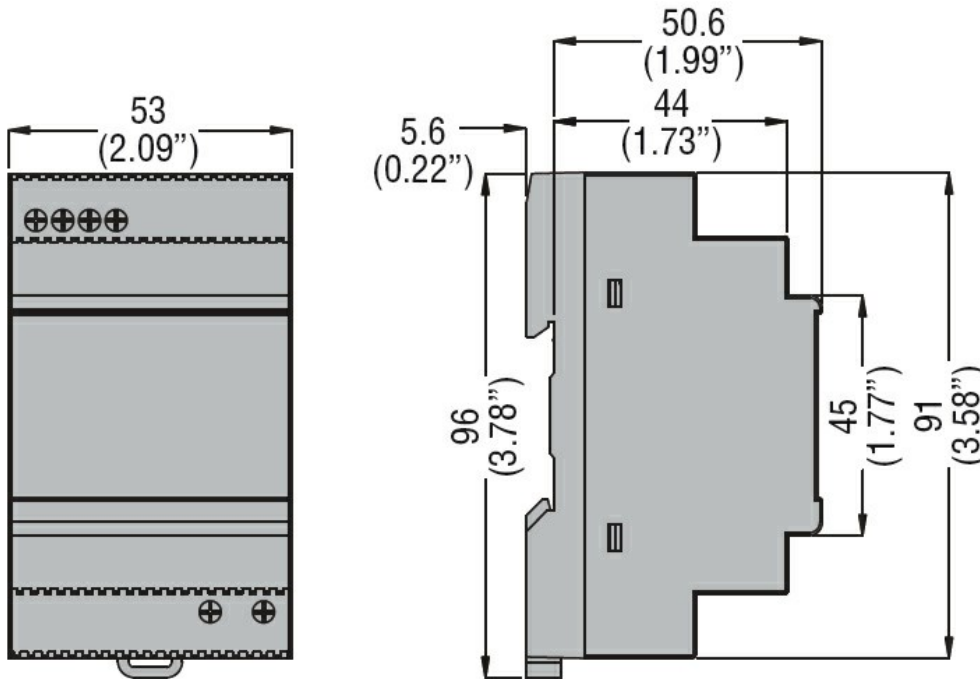

Wiring diagrams

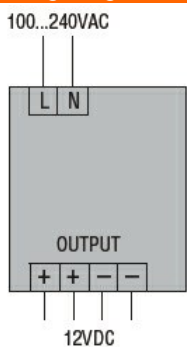

Certifications and compliance

Compliance

CSA C22.2 n°14

IEC/EN/BS 61000-6-2

IEC/EN/BS 61000-6-3

IEC/EN/BS 62368-1

UL 508

Certificates

cULus

EAC

RCM

ETIM classification

ETIM 8.0

EC002540 - DC-
power supply