



■ Features

- Buffering with electrolytic capacitors instead of lead acid batteries
- Type buffering time of 350ms @22Vdc/20A
- Buffer mode selectable by switch:
 - Fixed mode at 22Vdc
 - Dynamic mode for $V_{in}-1Vdc$
- LED indicator for signal status
- Supports parallel connection to extend buffering time
- Cooling by free air convection
- $-25\sim+75^{\circ}C$ wide operating temperature
- 3 years warranty

■ Applications

- Industrial control system
- Semiconductor fabrication equipment
- Factory automation
- Electro-mechanical apparatus

■ Description

The DBUF20-24 buffer module is a supplementary device for regulated DC 24V power supplies. The buffer module utilizes maintenance-free electrolytic capacitors to store energy, thus eliminates the need of periodic replacement as compared to costlier batteries which also have shorter functional life span. The DBUF20-24 comes with comprehensive protection features like over voltage, over current and short circuit protections. Buffer modules can be connected in parallel to increase the output ampacity or the hold-up time.

■ Model Encoding

DBUF 20 - 24

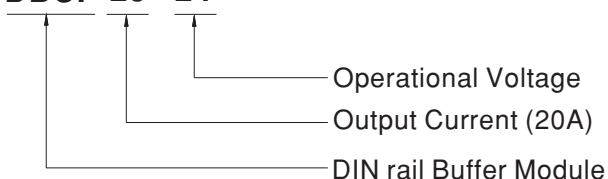



SPECIFICATION

MODEL	DBUF20-24				
CHARGING MODE	DC NORMAL OPERATING VOLTAGE	24Vdc			
	CHARGING VOLTAGE	23~30Vdc			
	CHARGING CURRENT	900mA Max.			
	CURRENT CONSUMPTION AT STANDBY	100mA Max.			
	CHARGING TIME	15s Typ. 25s Max.			
BUFFER MODE	DC NORMAL OPERATING VOLTAGE	22Vdc/Vin-1Vdc			
	DC OPERATING VOLTAGE RANGE	22-29Vdc			
	OUTPUT CURRENT(max.)	20A			
	BUFFER TIME (Refer to Buffering Curve at 22Vdc)	Output current	20A	10A	0.1A
		Typ.	350ms	700ms	45s
		Min.	250ms	500ms	30s
RIPPLE & NOISE (max.)	Note.2	200mVp-p			
PROTECTION	OVER VOLTAGE	31~37.5V only, shut down o/p voltage			
	OVER LOAD	105%~125% rated output power at buffer mode Protection type: Shut down o/p voltage , re-power on to recover			
	SHORT CIRCUIT	Protection type: Shut down o/p voltage , re-power on to recover			
	TVS FOR SIGNALS (max.)	35V			
	REVERSE POLARITY PROTECTION	By internal MOSFET, no damage , recovers automatically after fault condition removed			
FUNCTION	SELECTABLE BY SWITCH	Fix 22Vdc(Default)	Buffering starts if terminal voltage falls below 22Vdc		
		Vin-1Vdc	Buffering starts if terminal voltage is decreased by > 1Vdc		
	CONTROL	Inhibit (I)	+Vs - V(I) < 6Vdc: Buffer module ON; +Vs - V(I) > 10Vdc: Buffer module OFF		
			35Vdc /4mA Max.		
	SIGNALS	Ready(R)	Charged ready: V(R)>+Vs - 2Vdc; Unready: V(R)<1Vdc		
			35Vdc /10mA Max.		
		Buffering (B)	Buffering: V(B)>+Vs - 2Vdc; Other mode: V(B)<1Vdc		
			35Vdc /10mA Max.		
	Supply Voltage(+Vs)	10~35Vdc /10mA(Connected to +V or external voltage)			
	LED STATUS DISPLAY	ON		Ready	
OFF		Discharged			
Flashing		1Hz	Charging		
		10Hz	Buffering		
PARALLEL CONNECTION	Refer to Typical Application Notes(Page 6)				



ENVIRONMENT	WORKING TEMP.	-25~+75°C(Refer to"Derating Curve")		
	WORKING HUMIDITY	5 ~ 95% RH non-condensing		
	STORAGE TEMP.	-25~+80°C		
	SHOCK TEST	IEC60068-2-27,30G (300m/S ²) for a duration of 18ms,1 time per direction,2 times in total		
	TEMP. COEFFICIENT	±0.03%/°C (0 ~ 75°C)		
	VIBRATION	Component: 10 ~ 500Hz, 2G 10min./1cycle, 60min. each along X, Y, Z axes; Mounting clip: Compliance to IEC60068-2-6		
	OPERATING ALTITUDE Note.3	5000 meters /OVC II		
SAFETY & EMC (Note.4)	SAFETY STANDARDS	IEC62368-1,UL62368-1 approved		
	WITHSTAND VOLTAGE	IP/OP-FG:2.2KVdc; Signals-FG:2.2KVdc		
	ISOLATION RESISTANCE	IP/OP-FG, Signals-FG: >100M Ohms / 500Vdc / 25°C / 70% RH		
	EMC EMISSION	Parameter	Standard	Test Level / Note
		Conducted	EN55032	Class B
		Radiated	EN55032	Class B
		Voltage Flicker	-----	-----
		Harmonic Current	-----	-----
	EMC IMMUNITY	EN55035, EN61000-6-2		
		Parameter	Standard	Test Level / Note
		ESD	EN61000-4-2	Level 4, 15KV air ; Level 3, 8KV contact; criteria A
		Radiated	EN61000-4-3	Level 3, 10V/m ; criteria A
		EFT / Burst	EN61000-4-4	Level 3, 2KV ; criteria A
Surge		EN61000-4-5	Level 3, 1KV/Line-Line ;Level 3, 2KV/Line-Line-FG ;criteria A	
Conducted		EN61000-4-6	Level 3, 10V ; criteria A	
Magnetic Field		EN61000-4-8	Level 4, 30A/m ; criteria A	
OTHERS	MTBF	164.84K hrs min. MIL-HDBK-217F (25°C) ; 513.46K hrs min. Telcordia TR/SR-332 (Bellcore) (25°C) 107.97K hrs min. MIL-HDBK-217F (40°C) ; 255.89K hrs min. Telcordia TR/SR-332 (Bellcore) (40°C)		
	DIMENSION	63*125.2*114.9mm (W*H*D)		
	PACKING	1.062Kg; 12pcs/12.8Kg/0.74CUFT		
NOTE	<p>1. All parameters NOT specially mentioned are measured at normal input, rated load and 25°C of ambient temperature.</p> <p>2. Ripple & noise are measured at 20MHz of bandwidth by using a 12" twisted pair-wire terminated with a 0.1 μf & 47 μf parallel capacitor.</p> <p>3. The ambient temperature derating of 3.5°C/1000m with fanless models and of 5°C/1000m with fan models for operating altitude higher than 2000m(6500ft).</p> <p>4. The power supply is considered as an independent unit, but the final equipment still need to re-confirm that the whole system complies with the EMC directives. For guidance on how to perform these EMC tests, please refer to "EMI testing of component power supplies." (as available on http://www.meanwell.com)</p>			

Block Diagram

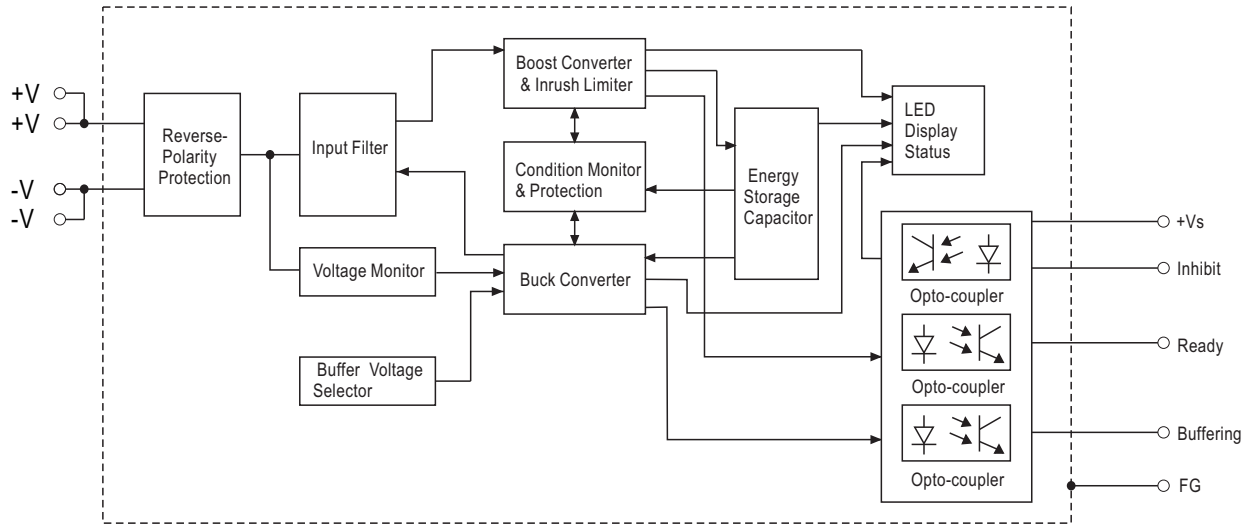

Derating Curve

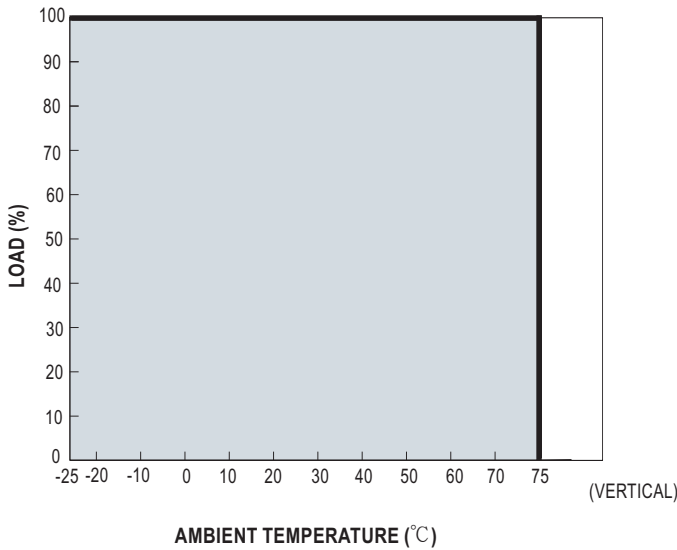

Buffering Curve

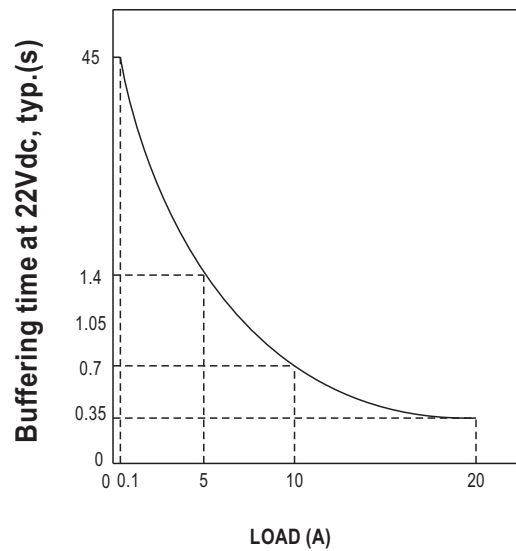

Function Manual

1. User Elements

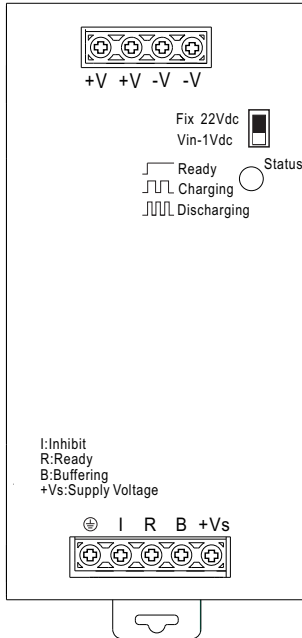

Back-up Threshold Voltage Selectable by Switch:

Option 1: Fixed mode (Switch in Fix 22Vdc)

The unit switches to buffer mode as soon as the voltage falls below 22Vdc.

Option 2: Dynamic mode (Switch in Vin-1Vdc)

Unit switches to buffer mode when input voltage decreases by 1Vdc.

Note: Factory setting is fixed mode.

LED Indicator Status:

LED OFF: Capacitors are discharged.

LED ON: Capacitors are fully charged.

LED Flashing slowly (1Hz): Capacitors are getting charged.

LED Flashing quickly (10Hz): Capacitors are getting discharged.

Signal Connector:

- Inhibit, +Vs - V(I) < 6Vdc: Buffer module ON; +Vs - V(I) > 10Vdc: Buffer module OFF.

- Ready, Charged ready: V(R) > +Vs - 2Vdc; Unready: V(R) < 1Vdc.

- Buffering, Buffering: V(B) > +Vs - 2Vdc; Other mode: V(B) < 1Vdc.

2. Operating Diagram

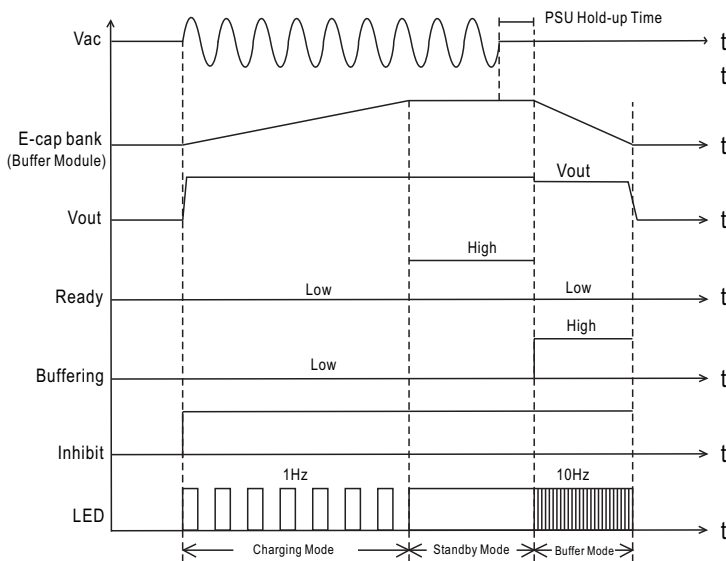

3. Signal Schematics

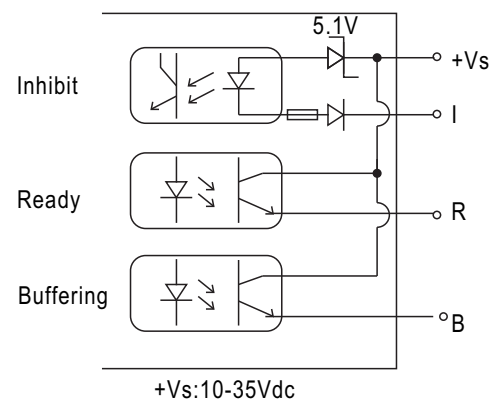

(+Vs can be connected to DBUF20 "+V" or external voltage source, Please refer to "Typical Application Notes")

Typical Application Notes

1. General wiring diagram

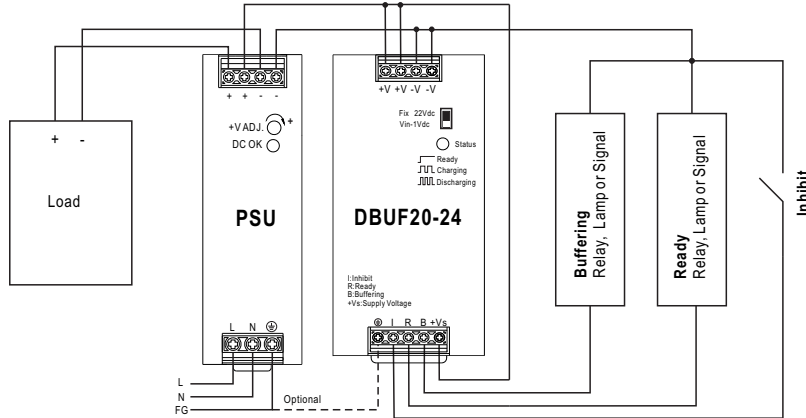

2. Signals supplied from an external voltage

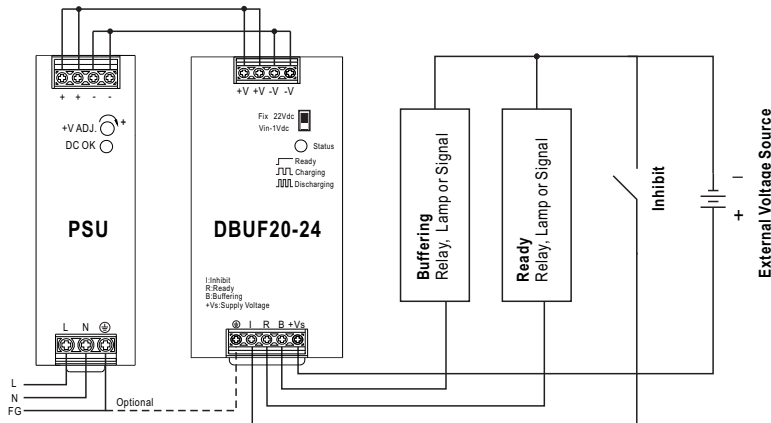

3. Paralleling of buffer units

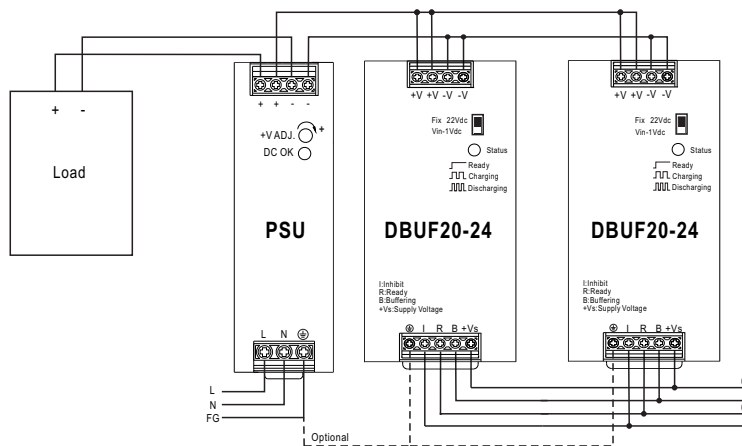

Mechanical Specification

Case No. 979E Unit:mm

Terminal Pin No. Assignment (TB1)

Pin No.	Assignment
1,2	DC +V
3,4	DC -V

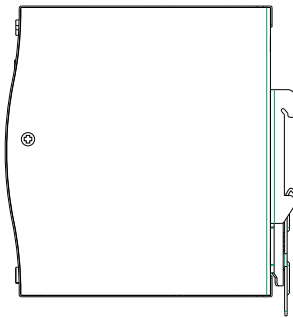
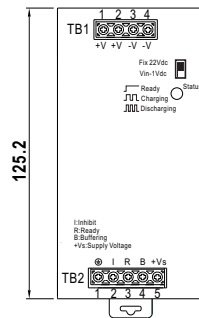
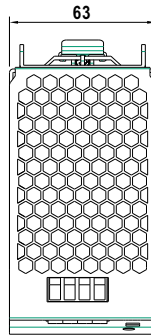
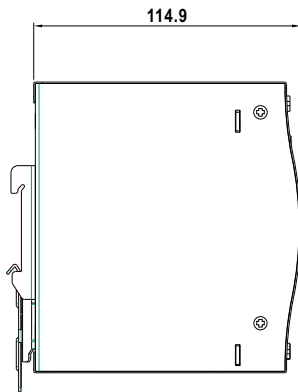

Terminal Pin No. Assignment (TB2)

Pin No.	Assignment
1	FG ⊕
2	Inhibit (I)
3	Ready (R)
4	Buffering (B)
5	Supply Voltage (+Vs)

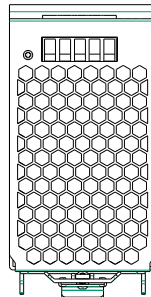

Installation Instruction

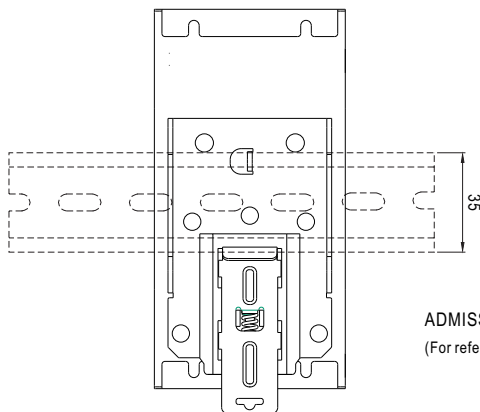

This series fits DIN rail TS35/7.5 or TS35/15.
For installation details, please refer to the Instruction manual.

ADMISSIBLE DIN-RAIL: TS35/7.5 or TS35/15
(For reference only. Not included with unit.)

Installation Manual

Please refer to : <http://www.meanwell.com/manual.html>