



INSTALLATION AND OPERATION MANUAL

Software Version 3.0x

Code 81503D / Edition 06 - 12/2010 ENG

GENERAL INDEX

	Page		
	2	4	Standard configuration menu 9
1	Preliminary instructions 2	5	Configuration and programming 10
	General description 2	6	Alarms 13
	Electrical interface 2	7	Control actions 13
	Preliminary warnings 3	8	Tecnica di Tune Manuale 14
2	Installation and connection 4	9	Software ON/OFF switching function 14
	Electrical power supply 4	10	Auto-tuning 14
	Notes concerning electrical safety and Electromagnetic compatibility 4	11	Self-tuning 15
	Advice for correct installation for EMC 5	12	Controls 15
	Instrument power supply 5	13	Technical specifications 16
	Inputs and outputs connection 5	14	Accessories 17
	Dimensions and cut-out 6		
	Installation with panel mounting 6		
	Warnings and instructions for mounting to the panel 6		
	Nominal ambient conditions 6		
	Electrical connections 7		
3	Functions 8		

The contents of each section are summarized immediately following the section heading

Graphic symbols used

To distinguish between the type and importance of the information provided in these instructions for use, graphic symbols have been used as a reference to make interpreting the information clearer.

 Indicates the contents of the various manual sections, the general warnings, notes, and other points to which the reader's attention should be drawn.

 Indicates a particularly delicate situation that could affect the safety and correct working operation of the controller, or a rule that must be strictly observed to avoid dangerous situations

 Indicates a condition of risk for the safety of the user, due to the presence of dangerous voltages at the points shown

 Indicates a suggestion based on the experience of the GEFTRAN Technical Staff, which could prove especially useful under given circumstances

 Indicates a reference to Detailed Technical Documents available on the GEFTRAN web site www.gefran.com

1 • PRELIMINARY INSTRUCTIONS

 *This section contains information and warnings of a general nature which should be read before proceeding with controller installation, configuration and use.*

General Description

Microprocessor controller, format 48x48 (1/16 DIN) manufactured using SMT.

The instruments provides a complete operator interface, protected by a Lexan® membrane that ensures level IP65 faceplate protection.

They have 4 keys, 4 digits display, 2 indicating LED's for 400 model, 3 indicating LED's for 401 model and a further 3 LED's bar-graph.

The main input for the process variable is universal and provides the possibility to connect many types of input sensor:

- Thermocouple type J, K, R, S, T, B, E, N
- Resistance thermometer PT100 3-wires
- Thermistor PTC
- Linear inputs 0...60mV, 12...60mV, 0...20mA, 4...20mA, 0...10V, 2...10V

The type of input is selected from the faceplate keys and no external shunts or adapter are required.

Model 401 can have an auxiliary input for a 50mAac current transformer to monitor the load current.

It is also possible to set an alarm point related to the current transformer input in order to check eventual load malfunction.

The instruments have 2 (3 for 401 model) relay (5A/250Vac, $\cos\phi=1$) or static (10Vdc/30mA) outputs with Heat, Cool or Heat/Cool and/or alarm function. All the programming procedures of the instruments are facilitated by the grouping of the parameters in function blocks (CFG for the control parameters, Inp for the inputs, Out for the outputs, etc.) and by the possibility of selecting a simplified menu for entering the most frequently used parameters.

To simplify the configuration even further, a programming kit is available for PC, which includes a menu driven configuration program for Windows and the necessary cable to connect the instrument (see technical data code WINSTRUM).

A configurable personal software protection code (password protection) can be used to restrict the levels of editing and displaying the configuration parameters.

Electrical Interface

All connection terminals (power supply, inputs, outputs, options) are grouped together on the back of the instrument.

For technical specifications and performance details refer to Section 13 "Technical Specifications".

Preliminary Warnings



The following preliminary warnings should be read before installing and using the series 400/401 controller.

This will allow the controller to be put into service more quickly and will avoid certain problems which may mistakenly be interpreted as malfunctions or limitations of the controller.

- Immediately after unpacking the controller, make a note of the order code and the other identification data given on the label affixed to the outside of the container and copy them to the table below. These details must always be kept close at hand and referred to the personnel involved in the event of help from Gefran Customer Service Assistance.

SN:	(Serial n°)
CODE:	(Finished product code)
TYPE:	(Order Code)
SUPPLY:	(Type of electrical power supply)
VERS:	(Software version)

- Check also that the instrument is complete and has not been damaged at all during transit, and that the package contains not only the controller and these Instructions for Use, but also the kit for fixing to the panel and the dust protection seal - see: Installation with Panel Fixing in Section 2. Any inconsistencies, omissions or evident signs of damage should be reported immediately to your Gefran sales agent.
- Check that the order code corresponds with the configuration requested for the application the instrument is needed for.
 - N°. and Type of Inputs/Outputs available
 - Presence of the necessary options and accessories
 - Mains voltage supply

Example: 400 – R – R – R – 0
Model 400
3 relay outputs
Power supply 11...27Vac/dc
- Before installing the instrument serie 400/401 on the control panel of the machine or host system, refer to the paragraph “Dimensions and Cut-out” in Section 2 “Installation and Connection”.
- Where configuration by PC is provided for, make sure the interface RS232 cable is available and the CD-ROM containing the WINSTRUM software. For the order code refer to Section 14 “Accessories”.



Users and/or system integrators who wish to know more about the concepts of serial communication between standard PC and or Gefran Industrial PC and Gefran Programmable Instruments, can access the various technical reference Documents in Adobe Acrobat format available in the Download section of the Gefran Web Site **www.gefran.com** including:

- Serial Communication
- MODBus Protocol

In the same Download section of the Gefran Web Site **www.gefran.com** the instrument serie 400/401 reference manual is available in Adobe Acrobat format, containing a detailed description of all the adjustable parameters and procedures.

In the event of presumed instrument malfunction, before contacting Gefran Technical Service Assistance, refer to the F.A.Q. Section (Frequently Asked Questions) on the Gefran Web Site **www.gefran.com**

2 • INSTALLATION AND CONNECTION



This section contains the instructions necessary for correct installation of the instrument series 400/401 into the machine control panel or the host system and for correct connection of the controller power supply, inputs, outputs and interfaces.



Before proceeding with installation read the following warnings carefully!

Remember that lack of observation of these warnings could lead to problems of electrical safety and electromagnetic compatibility, as well as invalidating the warranty.

Electrical power supply

- the instrument is NOT equipped with an On/Off switch: the user must provide a two-phase disconnecting switch that conforms to the required safety standards (CE marking), to cut off the power supply upstream of the instrument.
The switch must be located in the immediate vicinity of the instrument and must be within easy reach of the operator.
One switch may control more than one controller.
- if the instrument is connected to NOT isolated electrical equipment (e.g. thermocouples), the earth connection must be made with a specific conductor to prevent the connection itself from coming directly through the machine structure.

- if the instrument is used in applications with risk of damage to persons, machinery or materials, it is essential to connect it up to auxiliary alarm equipment. It is advisable to make sure that alarm signals are also triggered during normal operation. The instrument must NOT be installed in flammable or explosive environments; it may be connected to equipment operating in such atmospheres only by means of appropriate and adequate types of interface, conforming to the applicable safety standards.

Notes Concerning Electrical Safety and Electromagnetic Compatibility:

CE MARKING:

The instrument conforms to the European Directives 2004/108/CE and 2006/95/CE with reference to the generic standards: **EN 61000-6-2** (immunity in industrial environment) **EN 61000-6-3** (emission in residential environment) **EN 61010-1** (safety).

The instrument series 400/401 are mainly designed to operate in industrial environments, installed on the switchboards or control panels of productive €process machines or plants.

As regards electromagnetic compatibility, the strictest generic standards have been adopted, as indicated in the table below.

EMC conformity has been tested with the following connections.

Function	Cable type	Length
Power supply cable	1mm ²	1m
Relay output cables	1mm ²	3,5m
Thermocouple input	0,8mm ² compensated	5m
Linears input, "PT100" temperature resistance	1mm ²	3m
Digital Inputs / Outputs	1mm ²	3,5m

EMC Emission		
Generic standards, emission standard for residential commercial and light industrial environments	EN 61000-6-3	
Emission enclosure	EN 61000-6-3	
Emission AC mains	EN 61000-6-3	Group1 Class B
Radiated emission	EN 61326 CISPR 16-2	Class B
EMC Immunity		
Generic standards, immunity standard for industrial environments	EN 61000-6-2	
Immunity ESD	EN 61000-4-2	4 kV contact discharge level 2 8 kV air discharge level 3
Immunity RF interference	EN 61000-4-3 /A1	10 V/m amplitude modulated 80 MHz-1 GHz 10 V/m amplitude modulated 1.4 GHz-2 GHz
Immunity conducted disturbance	EN 61000-4-6	10 V/m amplitude modulated 0.15 MHz-80 MHz (level 3)
Immunity burst	EN 61000-4-4	2 kV power line (level 3) 2 kV I/O signal line (level 4)
Immunity pulse	EN 61000-4-5	Power line-line 1 kV (level 2) Power line-earth 2 kV (level 3) Signal line-earth 1 kV (level 2)
Immunity Magnetic fields	EN 61000-4-8	100 A/m (level 5)
Voltage dips, short interruptions and voltage immunity tests	EN 61000-4-11	100%U, 70%U, 40%U,
LVD Safety		
Safety requirements for electrical equipment for measurement, control and laboratory use	EN 61010-1	



Advice for Correct Installation for EMC

Instrument power supply

- The power supply to the electronic equipment on the switchboards must always come directly from an isolation device with a fuse for the instrument part.
- The electronic instruments and electromechanical power devices such as relays, contactors, solenoid valves, etc., must always be powered by separate lines.
- When the electronic instrument power supply is strongly disturbed by the commutation of transistor or power units or motors, an isolation transformer should be used for the controllers only, earthing the screen.
- It is essential that the plant has a good earth connection:
 - the voltage between neutral and earth must not be >1V
 - the Ohmic resistance must be < 6Ω;
- If the mains voltage fluctuates strongly, use a voltage stabilizer.
- In the proximity of high frequency generators or arc welders, use adequate mains filters.
- The power supply lines must be separate from the instrument input and output ones.

Inputs and outputs connection

- The externally connected circuits must be doubly isolated.
- To connect the analogue inputs and analog outputs the following is necessary:
 - physically separate the input cables from those of the power supply, the outputs and the power connections.
 - use woven and screened cables, with the screen earthed in one point only.
- To connect the relay outputs (contactors, solenoid valves, motors, fans, etc.), fit RC groups (resistance and condensers in series) in parallel to the inductive loads that operate in Alternating Current.

(Note: all the condensers must conform to VDE (class X2) standards and withstand a voltage of at least 220V AC. The resistances must be at least 2W).
- Fit a 1N4007 diode in parallel with the coil of the inductive loads that operate in Direct Current.



GEFRAN S.p.A. declines all responsibility for any damage to persons or property caused by tampering, neglect, improper use or any which does not conform to the characteristics of the controller and to the indications given in these instructions for Use.

Dimensions and cut-out

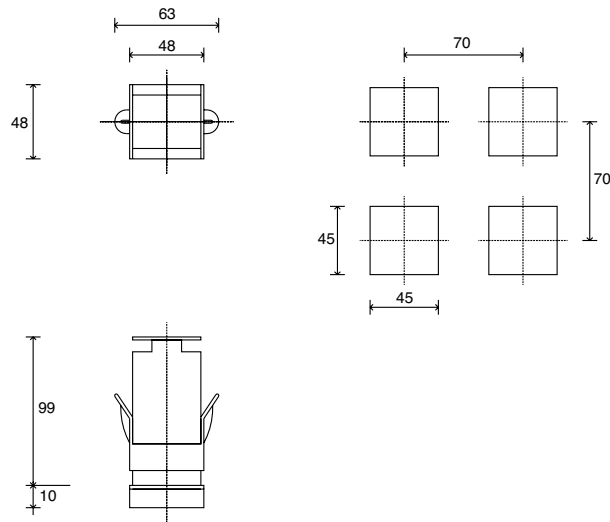

Installation with panel mounting

As well as the actual instrument and these instructions for use, the controller package also contains:

- panel fixing kit (A)
- 1 protective seal against dust and water spray (B)

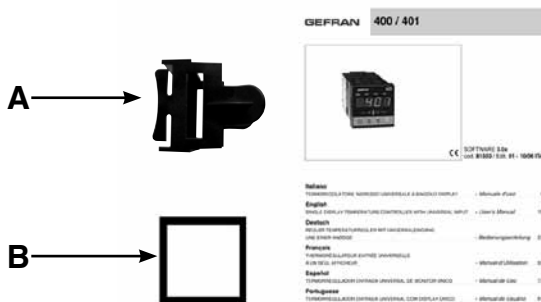

Fit the instrument to the panel as shown in the figure.

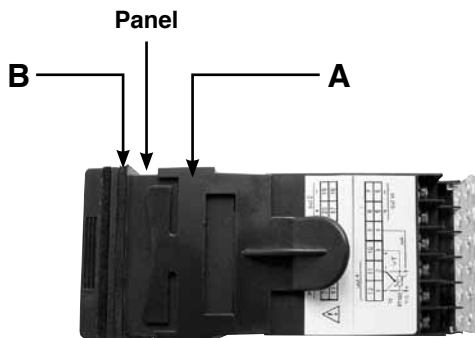

Warnings and instructions for mounting to the panel



Instructions for installation category II, pollution level 2, double isolation.

The equipment is intended for permanent indoor installations within their own enclosure or panel mounted enclosing the rear housing and exposed terminals on the back

- only for models with 11...27Vac/dc power supply: supply from Class 2 or low voltage limited energy source
- the power supply lines must be separate from the controller input and output ones
- group the instruments together keeping them separate from the powered part of the relay
- do not install high-power remote switches, contactors, relays, thyristor power units (especially the "phase angle" type), motors, etc. in the same switchboard
- avoid dust, humidity, corrosive gasses and heat sources
- do not block the ventilation holes: the working temperature must be between 0...50°C
- surrounding air: 50°C
- use 60/75°C copper (Cu) conductor only, wire size range 2x N. 22 - 14AWG, Solid/Stranded
- use terminal tightening torque 0.5Nm

Altitude	Up to 2000m
Working/storage temperature	0..50°C/-20...70°C
Non condensing relative humidity	20...85%

Nominal ambient conditions



Before supplying the Indicator with power, make sure that the mains voltage is the same as that shown in the last number of the order code.

Example:

400 - x - x - x - 0 = 11...27Vac/dc

400 - x - x - x - 1 = 100...240Vac

Electrical Connections

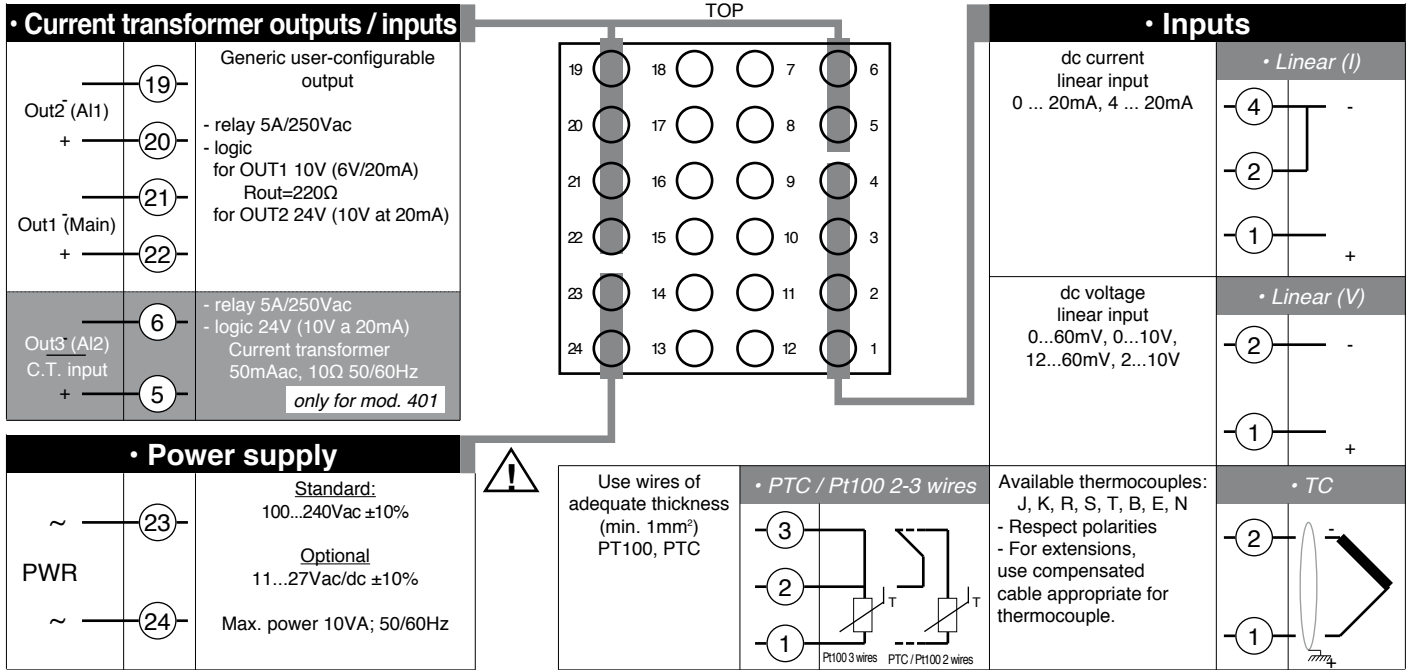

Device structure: identification of boards

CPU BOARD (Sealing Side)
 S6 = ON Enable Calibration

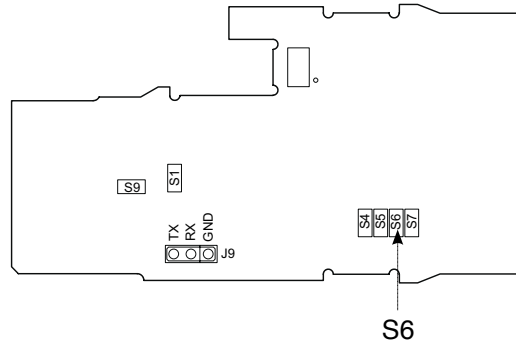

for inverse OUT1: S2 = ON, remove R20
 for inverse OUT2: S1 = ON, remove R5

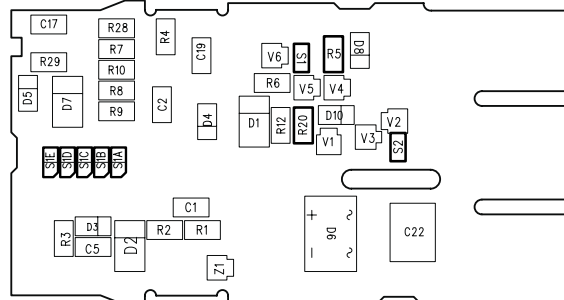

power HV RR sealing side (HV RD)

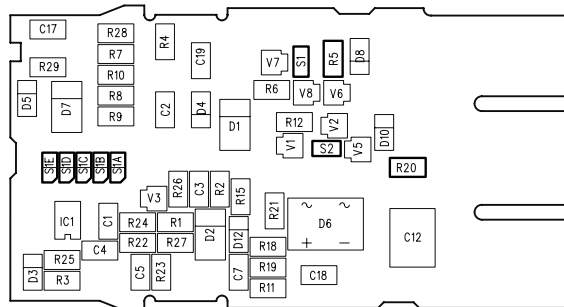

power LV RR sealing side (LV RD)

3 • FUNCTIONS



This section describes the use and functions of the displays, lighted indicators and buttons making up the controller operator interface.

It therefore contains essential information for correct programming and configuration of the controllers.

Operator interface

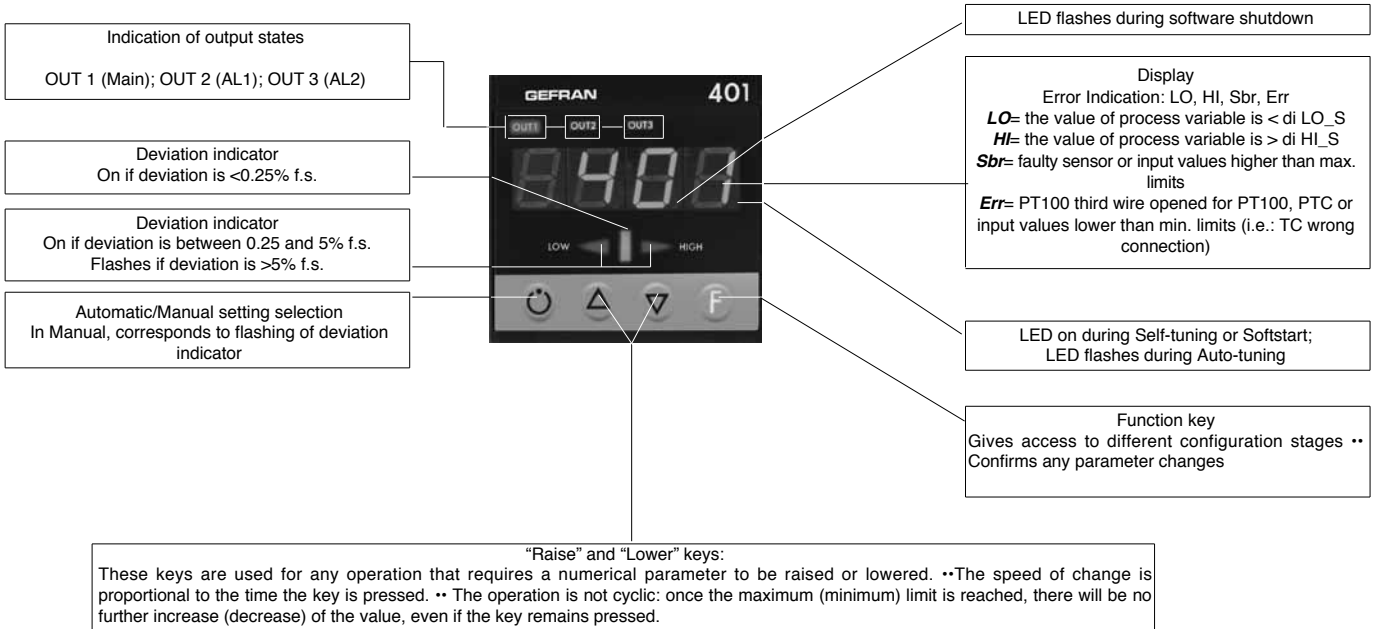

4 · STANDARD CONFIGURATION MENU

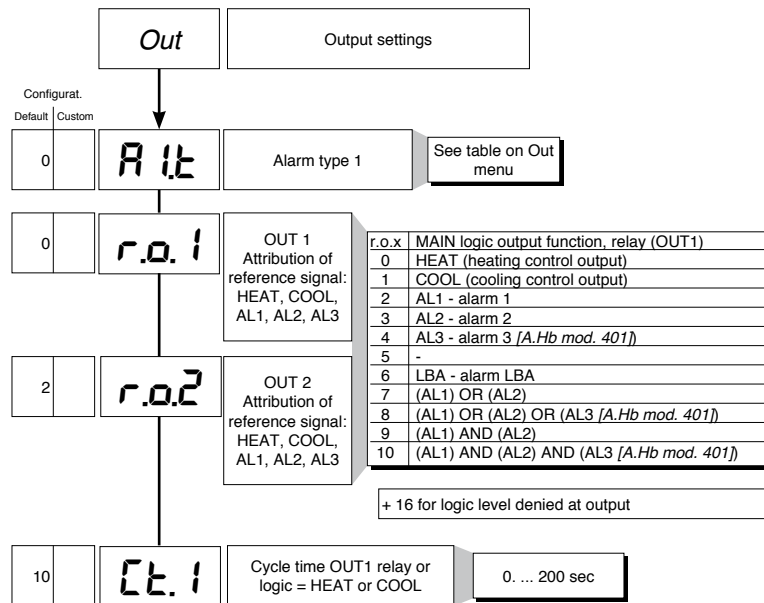
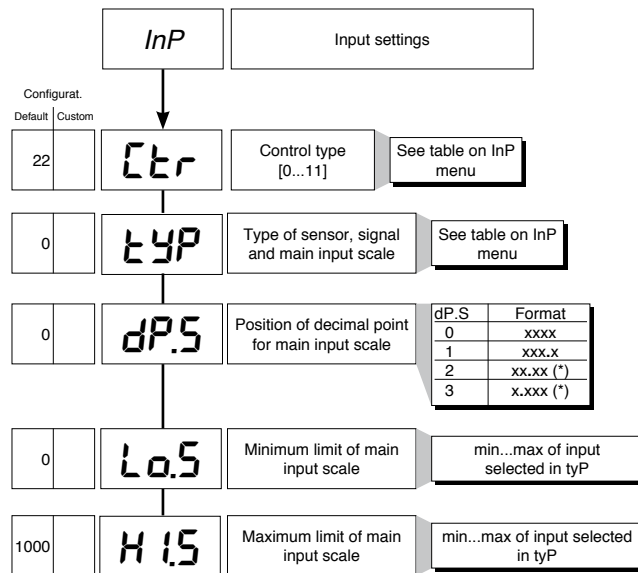
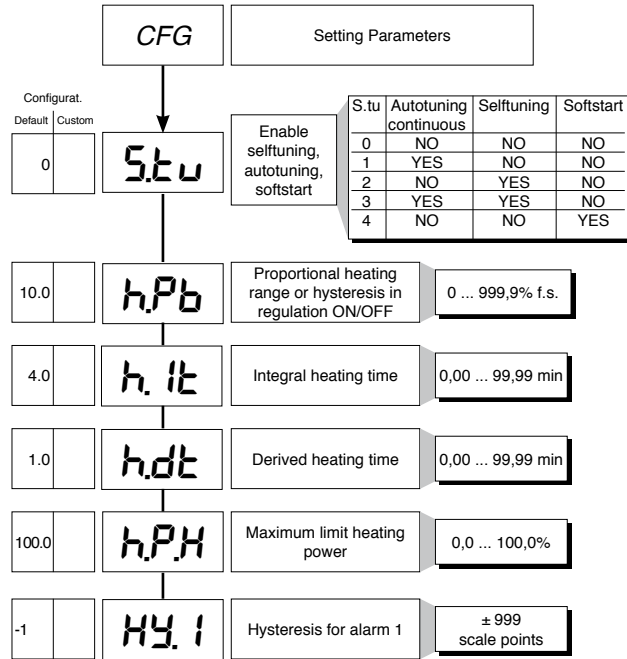

5 • PROGRAMMING and CONFIGURATION

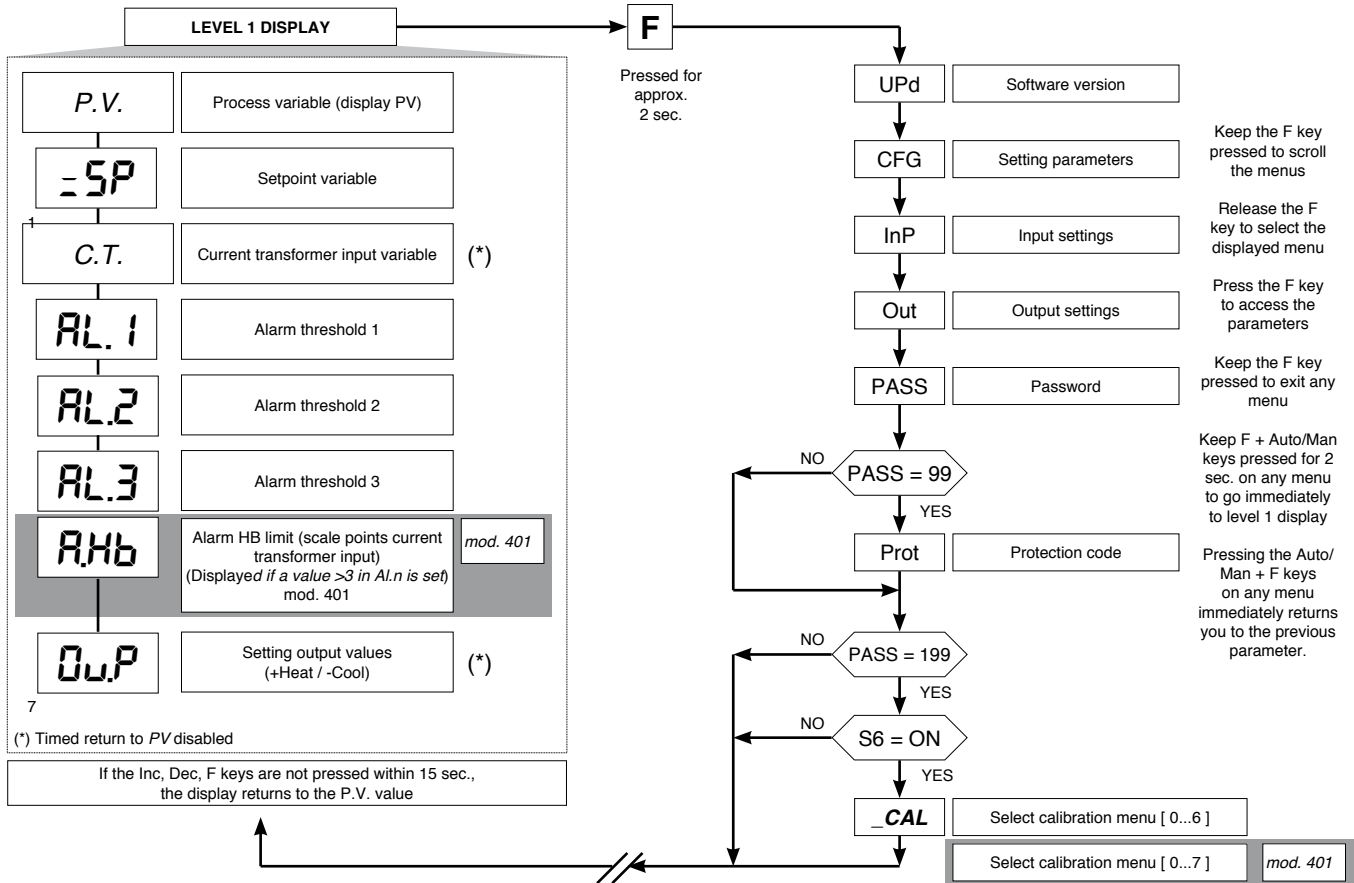

NB: Parameters not required for a particular configuration are not displayed

• CFG

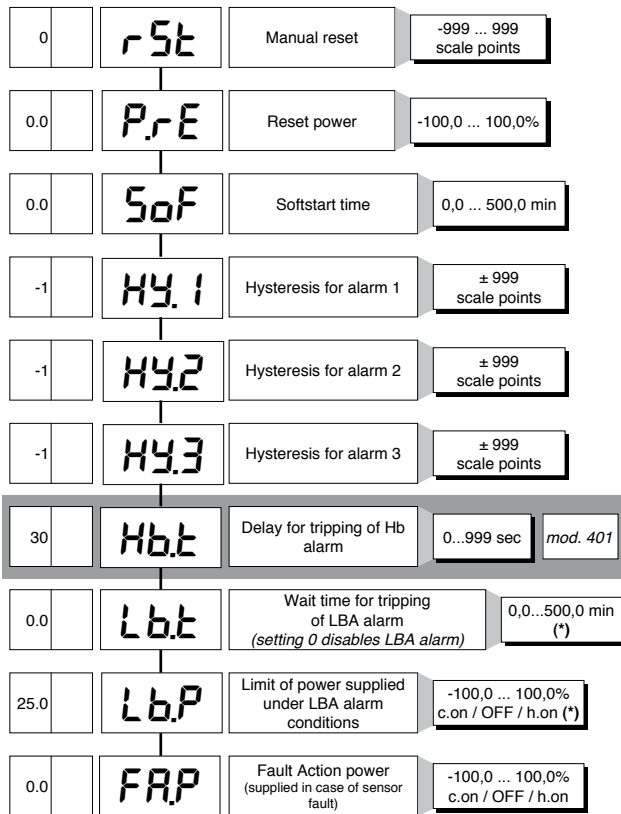
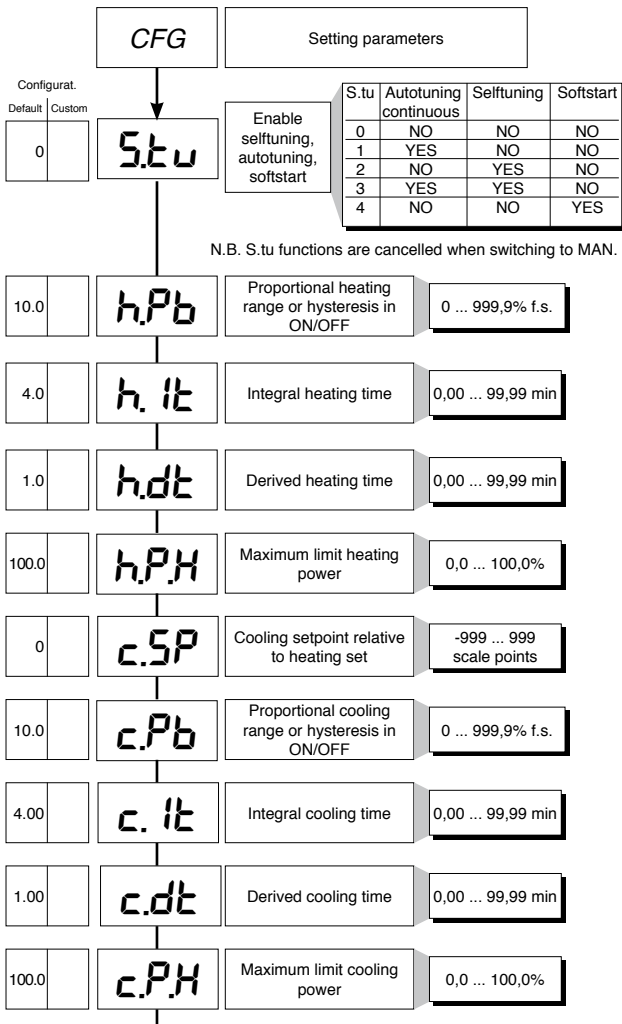

(*) If the LBA alarm is active (display flashing alternately with 4 decimal points), you can cancel it by pressing keys Δ + ▽ when OutP is seen, or by switching to Manual.

N.B.: the LBA alarm is excluded for ON/OFF controls

InP Input settings

Configurat. Default Custom

22 **Ctrl** Type of control [0...91]

Ctrl	Type of control
0	P hot
1	P cold
2	P hot / cold
3	PI hot
4	PI cold
5	PI hot / cold
6	PID hot
7	PID cold
8	PID hot / cold
9	ON-OFF hot
10	ON-OFF cold
11	ON-OFF hot / cold

+16 disable parameters
CFG: rst, PrE, SoF, Lbt, Lbp, FAP, HY.2, HY.3 (only for model 400)
InP: FLt, FLd, oFS, LoL, HIL
Out: ALn, A2t, A3t (only for model 400), rEL

FLt, FLd, oFS stay at set value.
 ALn is forced to 1 (only for mod. 400)
 All other parameters are considered 0.

Default: derived action sample time = 1 sec
 +32: derived action sample time = 8sec
 +64: derived action sample time = 240msec with derived action filter assigned to Fit parameter (time filter)

0 **LYP** Type of probe, signal and scale of main input

SENSOR: TC (CAL = 1)				
tYP	Type of probe	Scale (C/F)	Max. scale range without decimal point	Max. scale range with decimal point
0	J (Fe-CuNi)	C	0 / 1000	0,0 / 999,9
1	J (Fe-CuNi)	F	32 / 1832	32,0 / 999,9
2	K (NiCr-Ni)	C	0 / 1300	0,0 / 999,9
3	K (NiCr-Ni)	F	32 / 2372	32,0 / 999,9
4	R (Pt13Rh - Pt)	C	0 / 1750	0,0 / 999,9
5	R (Pt13Rh - Pt)	F	32 / 3182	32,0 / 999,9
6	S (Pt10Rh - Pt)	C	0 / 1750	0,0 / 999,9
7	S (Pt10Rh - Pt)	F	32 / 3182	32,0 / 999,9
8	T (Cu-CuNi)	C	-200 / 400	-199,9 / 400,0
9	T (Cu-CuNi)	F	-328 / 752	-199,9 / 752,0
10	B (Pt30Rh - Pt6Rh)	C	44 / 1800	44,0 / 999,9
11	B (Pt30Rh - Pt6Rh)	F	111 / 3272	111,0 / 999,9
12	E (NiCr-CuNi)	C	-100 / 750	-100,0 / 750,0
13	E (NiCr-CuNi)	F	-148 / 1382	-148,0 / 999,9
14	N (NiCrSi-NiSi)	C	0 / 1300	0,0 / 999,9
15	N (NiCrSi-NiSi)	F	32 / 2372	32,0 / 999,9

SENSOR: RTD 3 wires (CAL = 2)				
tYP	Type of probe	Scale (C/F)	Max. scale range without decimal point	Max. scale range with decimal point
16	PT100	C	-200 / 850	-199,9 / 850,0
17	PT100	F	-328 / 1562	-199,9 / 999,9

SENSOR PTC (CAL = 3)				
tYP	Type of probe	Scale (C/F)	Max. scale range without decimal point	Max. scale range with decimal point
18	PTC	C	-55 / 120	-55,0 / 120,0
19	PTC	F	-67 / 248	-67,0 / 248,0

SENSOR: VOLTAGE 60mV (CAL = 4)			
tYP	Signal type	Scale	Max. scale range
20	0...60mV	linear	-1999 / 9999
21	12...60mV	linear	-1999 / 9999

SENSOR: CURRENT 20mA or TRANSMITTER (CAL = 5)			
tYP	Signal type	Scale	Max. scale range
22	0...20mA	linear	-1999 / 9999
23	4...20mA	linear	-1999 / 9999

SENSOR: VOLTAGE 10V or TRANSMITTER (CAL = 6)			
tYP	Signal type	Scale	Max. scale range
24	0...10V	linear	-1999 / 9999
25	2...10V	linear	-1999 / 9999

With mod. 401, set CAL=7 to calibrate the current transformer input

SENSOR CT: CURRENT 50mAac (CAL = 7)			
Signal type	Scale	Max. scale range	
0 ... 50mAac	linear	0 ... 99,9	

Max. non-linearity error for thermocouples (TC), resistors (PT100) and thermistors (PTC).

The error is calculated as deviation from theoretical value and is expressed as percentage of full scale (in °C)

S, R range 0...1750°C; error < 0.2% f.s. (t > 300°C) / for other range; error < 0.5% f.s.
T error < 0.2% f.s. (t > -150°C)
B range 44...1800°C; error < 0.5% f.s. (t > 300°C) / range 44,0...999,9; error < 1% f.s. (t > 300°C)

Tc: J, K, E, N, error < 0,2% f.s.
 PTC error < 0,2% f.s.
 PT100 scale -200...850°C
 Precision better than 0,2% f.s. at 25°C

0.1 **FLt** Digital filter on main input 0,0 ... 20,0 sec

0.5 **FLd** Digital filter on display of process variable; acts as hysteresis 0 ... 9,9 scale points

0 **dPS** Decimal point position for main input scale

dP.S	Format
0	xxxx
1	xxx.x
2	xx.xx (*)
3	x.xxx (*)

(*) not available for TC, RTD, PTC scales

0 **LoS** Minimum limit of main input scale min...max scale of input selected in tyP

1000 **HiS** Maximum limit of main input scale min...max scale of input selected in tyP

0 **oFS** Main input offset correction -999 ... 999 scale points

99.9 **HiA** Max. current transformer input scale 0,0...99,9 mod. 401

0 **LoL** Lower limit for local setpoint and absolute alarms Lo.S ... Hi.S

1000 **HiL** Upper limit for local setpoint and absolute alarms Lo.S ... Hi.S

• Out

Out Output settings

Configurat. Default Custom

1 **ALn** Number of alarms 0 ... 3 mod. 400 0 ... 6 mod. 401

4, 5, 6 to select HB alarm as alternative to alarm 3

0 **A1t** Alarm type 1

AL.x	Direct (maximum) Inverse (minimum)	Absolute Relative to active setpoint	Normal Symmetrical (window)
0	direct	absolute	normal
1	inverse	absolute	normal
2	direct	relativo	normal
3	inverse	relativo	normal
4	direct	absolute	symmetrical
5	inverse	absolute	symmetrical
6	direct	relativo	symmetrical
7	inverse	relativo	symmetrical

0 **A2t** Alarm type 2

0 **A3t** Alarm type 3 + 8 to disable on power-up until first alarm

0 **Hb.F** Function of HB alarm mod. 401

Hb_F	Description
0	Relay, logic output: alarm active with load current value below limit set in ON time of control output
1	Relay, logic output: alarm active with load current value above limit set in OFF time of control output
2	Alarm active if one of functions 0 and 1 is active (OR logic for functions 0 and 1) (*)
3	Alarm HB continuous heating (**)
7	Alarm HB continuous cooling (**)

+0 assigned to OUT1 (only for Hb_F = 0, 1, 2)
 +4 assigned to OUT2 (only for Hb_F = 0, 1, 2)
 +16 alarm HB reverse

(*) minimum limit is set = 12.5% of current transformer f.s.
 (**) As type 0 without reference to cycle time .

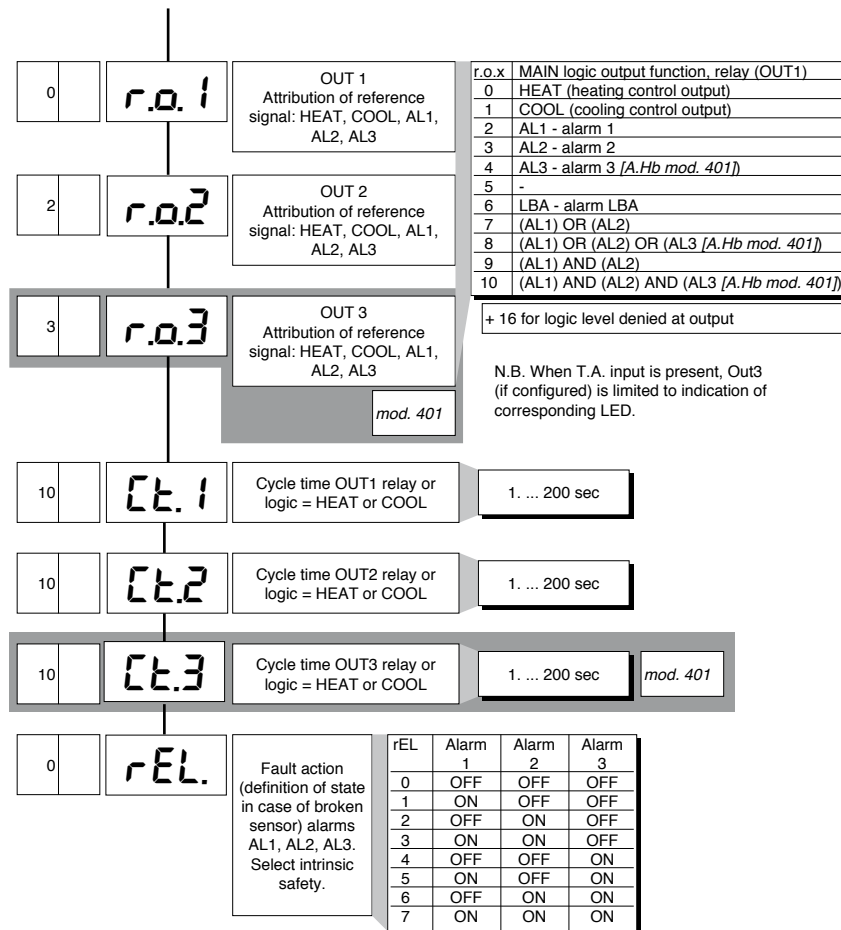

- 1) In case of broken sensor, the logic state of the alarm assumes the logic value selected without consideration of alarm type (direct or reverse): ON = alarm active, OFF = alarm inactive.
- 2) Alarms are assigned to available outputs by setting codes r.o.1, r.o.2, r.o.3.

• Prot

Pro	Protection code	
Pro	Display	Change
0	SP, alarms, OutP	SP, alarms
1	SP, alarms, OutP	SP
2	SP	SP
3	SP	

+4 disables InP, Out
+8 disables CFG
+16 disables "SW turn on - turn off"
+32 disables MAN/AUTO key
+ 64 to disable manual power memorization

To activate the turn off SW function, press keys F + Δ for 5 secs. in P.V.
To return to normal functioning, press key F for 5 secs.

FUNCTION OF HB ALARM (only for mod. 401)

This type of alarm is conditioned by use of the current transformer input. (T.A.)

It signals variations of load absorption by discriminating the level of current at the transformer input in the range (0...HI.A). It is enabled with configuration code (AL.n); in this case the alarm trip value is expressed in HB scale points.

Select the type of functioning and the assigned control output by means of code Hb.F ("Out" phase).

The alarm limit setting is A.Hb.

The direct HB alarm trips if the value of the current transformer input is below the set limit for Hb.t seconds inclusive of "ON" time of the selected output.

The HB alarm can be activated only with ON times longer than 0.4 seconds.

HB alarm function also includes control of load current in the OFF interval of the cycle time for the selected output: the HB alarm will trip if the measured current exceeds approximately 12.5% of the full scale set (parameter HI.A in InP) for Hb.t seconds inclusive of the OFF state of the output.

The alarm is reset automatically if the cause of the alarm is eliminated.

Setting a limit of A.Hb = 0 disables both types of HB alarms, with de-energizing of the assigned relay.

Indication of load current is displayed by selecting term C.T. (level 1).

NOTE: ON/OFF times refer to the cycle time set for the selected output.

Alarm Hb_F = 3 (7) continuous is active for a load current value below the set limit; it is disabled if the value of the heating/cooling output is less than 2%.

6 · ALARMS

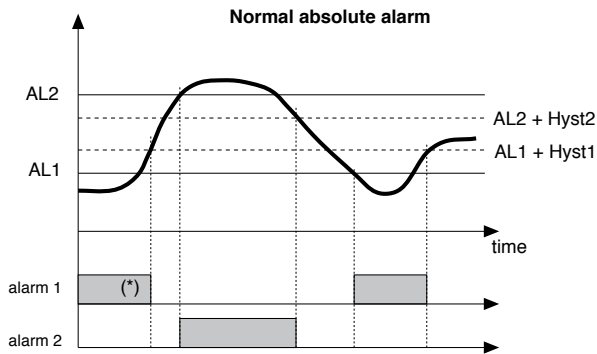

For AL1 = reverse absolute alarm (low) with positive Hyst1, AL1 t = 1
 (*) = OFF if disabled on power-up
 For AL2 = direct absolute alarm (high) with negative Hyst2, AL2 t = 0

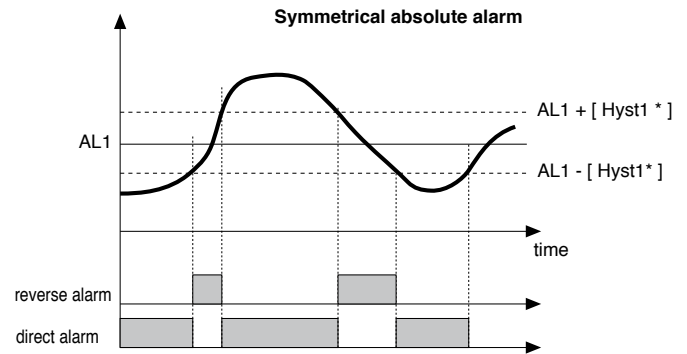

For AL1 = symmetrical Lo absolute alarm with Hyst1, AL1 t = 5
 For AL1 = symmetrical Hi absolute alarm with Hyst1, AL1 t = 4

* Minimum hysteresis = 2 scale points

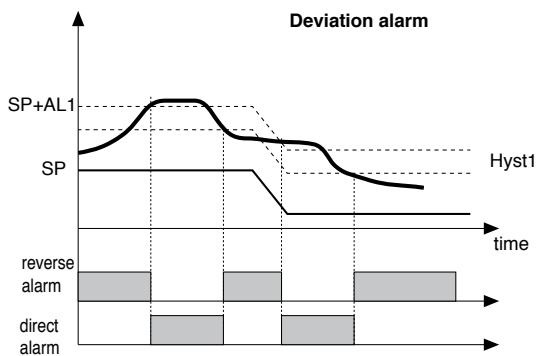

For AL1 = Lo deviation alarm with negative Hyst 1, AL1 t = 3
 For AL1 = Hi deviation alarm with negative Hyst 1, AL1 t = 2

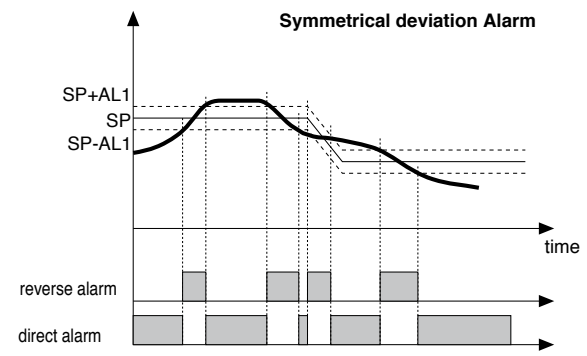

For AL1 = Symmetrical Lo deviation alarm with Hyst 1, AL1 t = 7
 For AL1 = Symmetrical Hi deviation alarm with Hyst 1, AL1 t = 6

7 · CONTROL ACTIONS

Proportional Action:

action in which contribution to output is proportional to deviation at input (deviation = difference between controlled variable and setpoint).

Derivative Action:

action in which contribution to output is proportional to rate of variation input deviation.

Integral Action:

action in which contribution to output is proportional to integral of time of input deviation.

Influence of Proportional, Derivative and Integral actions on response of process under control

* An increase in P.B. reduces oscillations but increases deviation.

* A reduction in P.B. reduces the deviation but provokes oscillations of the controlled variable (the system tends to be unstable if P.B. value is too low).

* An increase in Derivative Action corresponds to an increase in Derivative Time, reduces deviation and prevents oscillation up to a critical value of Derivative Time, beyond which deviation increases and prolonged oscillations occur.

* An increase in Integral Action corresponds to a reduction in Integral Time, and tends to eliminate deviation between the controlled variable and the setpoint when the system is running at rated speed.

If the Integral Time value is too long (Weak integral action), deviation between the controlled variable and the setpoint may persist.

Contact GEFTRAN for more information on control actions.

8 • MANUAL TUNING

- A) Enter the setpoint at its working value.
B) Set the proportional band at 0.1% (with on-off type setting).

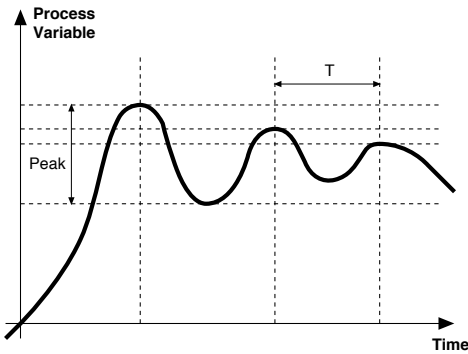

- C) Switch to automatic and observe the behavior of the variable. It will be similar to that in the figure:
D) The PID parameters are calculated as follows: Proportional band

$$P.B. = \frac{\text{Peak}}{(V \text{ max} - V \text{ min})} \times 100$$

(V max - V min) is the scale range.

Integral time: $I_t = 1.5 \times T$

Derivative time: $d_t = I_t/4$

- E) Switch the unit to manual, set the calculated parameters. Return to PID action by setting the appropriate relay output cycle time, and switch back to Automatic.

- F) If possible, to optimize parameters, change the setpoint and check temporary response. If an oscillation persists, increase the proportional band. If the response is too slow, reduce it.

9 • SOFTWARE ON / OFF SWITCHING FUNCTION

How to switch the unit OFF: hold down the “F” and “Raise” keys simultaneously for 5 seconds to deactivate the unit, which will go to the OFF state while keeping the line supply connected and keeping the process value displayed. The SV display is OFF.

All outputs (alarms and controls) are OFF (logic level 0, relays de-energized) and all unit functions are disabled except the switch-on function and digital communication.

How to switch the unit ON: hold down the “F” key for 5 seconds and the unit will switch OFF to ON. If there is a power failure during the OFF state, the unit will remain in OFF state at the next power-up (ON/OFF state is memorized).

The function is normally enabled, but can be disabled by setting the parameter Prot = Prot +16.

10 • AUTO-TUNING

Enabling the auto-tuning function blocks the PID parameter settings.

Is activated via the Stu parameter (values 1, 3).

It continuously reads system oscillations, immediately seeking the PID parameter values that reduce the current oscillation.

It does not engage if the oscillations drop below 1.0% of the proportional band. It is interrupted if the set-point is changed, and automatically resumes with a constant set-point.

The calculated parameters are not saved if the instrument is switched off, if the instrument is switched to manual, or if the configuration code is disabled.

The controller resumes with the parameters programmed before auto-tuning was enabled.

11 • SELF-TUNING

The function works for single output systems (heating or cooling). The self-tuning action calculates optimum control parameter values during process startup. The variable (for example, temperature) must be that assumed at zero power (room temperature).

The controller supplies maximum power until an intermediate value between starting value and setpoint is reached, after which it zeros power.

PID parameters are calculated by measuring overshoot and the time needed to reach peak. When calculations are finished, the system disables automatically and the control proceeds until the setpoint is reached.

How to activate self-tuning at power-on:

1. Set the setpoint to the required value
2. Enable selftuning by setting the Stun parameter to 2 (CFG menu)
3. Turn off the instrument
4. Make sure the temperature is near room temperature
5. Turn on the instrument again

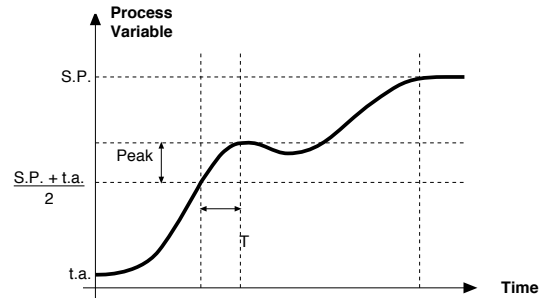

The procedure runs automatically until finished, when the new PID parameters are stored: proportional band, integral and derivative times calculated for the active action (heating or cooling). In case of double action (heating or cooling), parameters for the opposite action are calculated by maintaining the initial ratio between parameters (ex.: $CPb = HPb * K$; where $K = CPb / HPb$ when self-tuning starts). When finished, the Stun code is automatically cancelled.

Notes :

The procedure does not start if the temperature is higher than the setpoint (heating control mode) or if the temperature is lower than the setpoint (cooling control mode). In this case, the Stu code is not cancelled.

Action not considered in the type of control ON/OFF

12 • CONTROLS

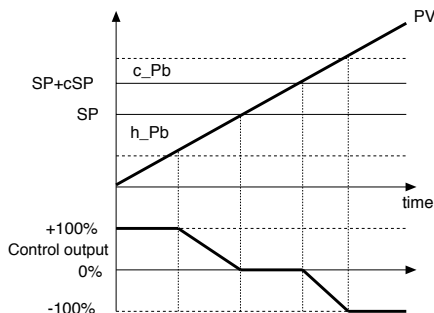

Control output with proportional action only if proportional heating band overlaps proportional cooling band.

PV = Process Value
 SP+cSP = cooling setpoint
 c_Pb = Proportional cooling band

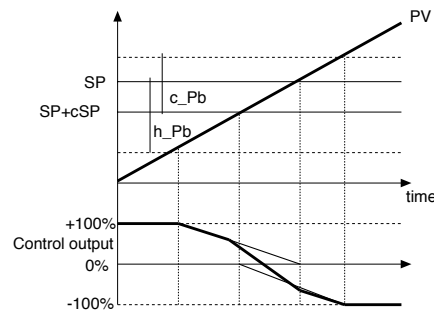

Control output with proportional action only if proportional heating band overlaps proportional cooling band.

SP = Heating Setpoint
 h_Pb = proportional heating band

13 • TECHNICAL SPECIFICATIONS

Display	4 digit green LED's, digit height 10mm
Keys	4 mechanical keys (Man/Aut, Raise, Lower, F)
Accuracy	0.25% f.s. at 25°C ambient temperature
Main input	TC, RTD (Pt100), PTC 60mV Ri ≥ 1MΩ, 10V Ri ≥ 10KΩ, 20mA Ri = 50Ω
Thermocouples	IEC 584-1 (J, K, R, S, T, B, E, N)
Cold junction error	0,1° / °C
RTD type (scale configurable within indicated range, with or without decimal point)	DIN 43760 (Pt100)
Max. RTD line resistance	20Ω
PTC type	990Ω, 25°C
Safety	Detection of short circuit or opening of sensors, LBA alarm, HB alarm (401)
°C / °F selection	Faceplate configurable
Linear scale ranges	-1999...9999, configurable decimal point position
Control actions	Pid, Autotune, on-off
pb	0,0...999,9 %
dt	0,00...99,99 min
di	0,00...99,99 min
Action	Heat or cool
Control outputs	on/off, pwm
Limitation Max power heat / cool	0,0...100,0 %
Cycle time	0...200 sec
Type of main output	Relay, logic
Softstart	0,0...500,0 min
Fault power setting	-100,0...100,0 %
Power off function	Maintains PV display; can be excluded
Configurable alarms	Up to 3 alarm functions assignable to an output and configurable as: maximum, minimum, symmetrical, absolute/relative, LBA, HB (401)
Alarm masking	Exclude on power-up
Relay contact	NO (NC), 5A, 250V cosφ = 1
Logic output for static relays	10Vdc (6V/20mA) for OUT1, 24Vdc (10V/20mA) for OUT2/OUT3
Optional current transformer input (mod. 401)	C.T. 50mAac, 50/60Hz, Ri = 10Ω
Power supply	(standard) 100...240Vac ±10% (optional) 11...27Vac/dc ±10% 50/60Hz, max 10VA
Faceplate protection	IP65
Working / Storage temperatures	0...50°C/-20...70°C
Relative humidity	20...85% non condensing
Environmental conditions of use	For internal use only, altitude up to 2000m
Installation	Panel mounting, extractable from front
Weight	160g for the complete version

14 · ACCESSORIES

· Current transformer

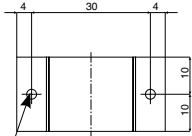
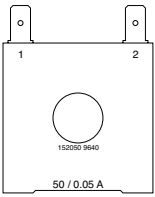

Hole for 2.9 x 9 self-threading screws

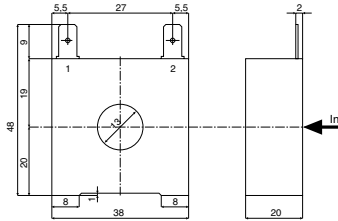

These transformers are used to measure currents of $50 \pm 60\text{Hz}$ from 25A to 600A (nominal primary current). The peculiar characteristic of these transformers is the high number of secondary turns. This provides a very low secondary current, suitable for an electronic measurement circuit. The secondary current may be detected as voltage on a resistor.

CODE	I_p / I_s	\varnothing Secondary Wire	n	OUTPUTS	R_u	V_u	ACCURACY
TA/152 025	25 / 0.05A	0.16 mm	$n^{1:2} = 500$	1 - 2	40Ω	2 Vac	2.0 %
TA/152 050	50 / 0.05A	0.18 mm	$n^{1:2} = 1000$	1 - 2	80Ω	4 Vac	1.0 %

· ORDER CODE

COD. 330200	IN = 50Aac OUT = 50mAac
COD. 330201	IN = 25Aac OUT = 50mAac

· RS232 / TTL interface cable for configuration of GEFRAN instruments

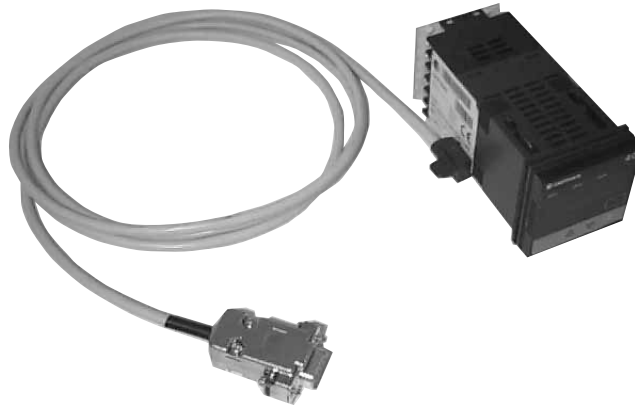

N.B.: The RS232 interface for configuration from PC is supplied along with the programming software. Connect with the instrument powered and with inputs and outputs not connected.

· ORDER CODE

COD. WSK-0-0-0	Interface Cable + CD Winstrum
----------------	----------------------------------

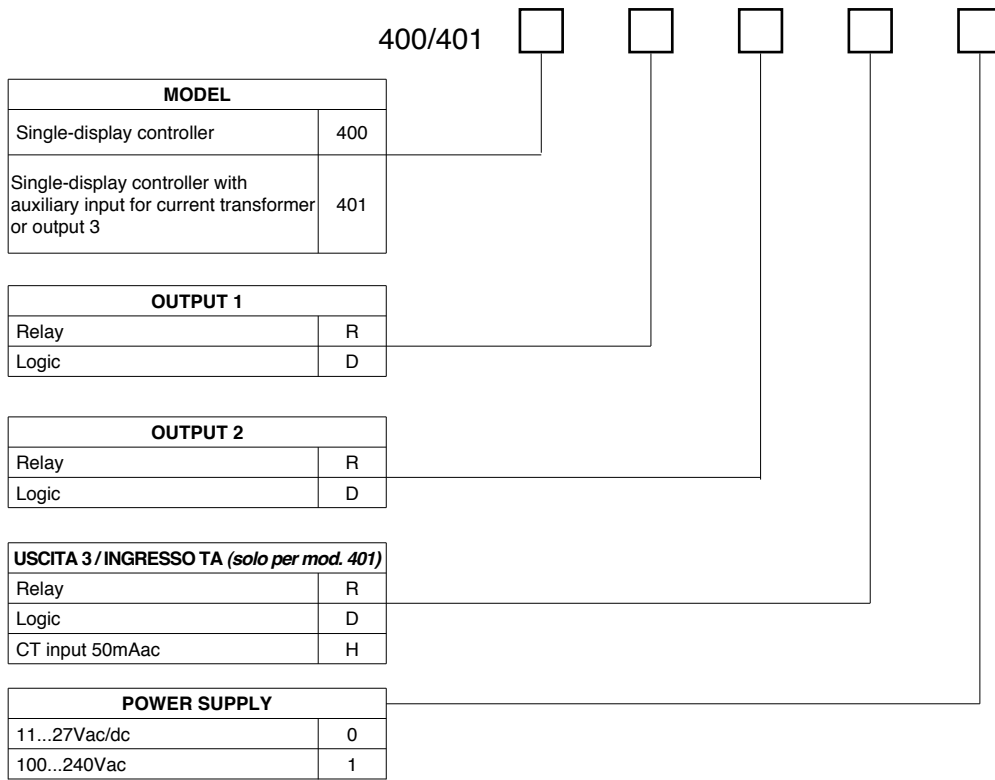

Please, contact GEFRA sales people for the codes availability.

• SCHEDE INGRESSI / USCITE • INPUT/OUTPUT BOARDS • CARTES D'ENTREES/SORTIES • E/A-KARTEN • FICHAS ENTRADAS/SALIDAS • PLACAS DE ENTRADAS/SAÍDAS

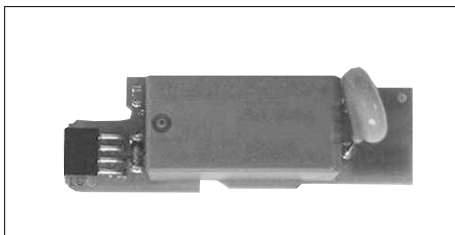

USCITA RELÉ (OUT3)
RELAY OUTPUT (OUT3)
SORTIE RELAIS (OUT3)
RELAISAUSGANG (OUT3)
SALIDA RELÉ (OUT3)
SAÍDA DE RELÉ (OUT3)

PROFILO

Questa scheda supporta la funzione di uscita prevista come OUT3 nello strumento 401. Adatta a pilotare carichi resistivi sino ad un massimo di 5A a 250Vac / 30Vdc. La schedina è automaticamente riconosciuta dallo strumento che abilita visibilità ed impostazione dei parametri relativi.

PROFILE

This board supports the output function provided as OUT3 on the 401 instrument. Suitable for piloting resistive loads up to a maximum of 5A at 250V AC/30Vdc. The board is automatically recognized by the instrument, which enables display and setting of the parameters involved.

GENERALITES

Cette carte supporte la fonction sortie prévue comme OUT3 dans l'outil 401. Elle est apte à piloter des charges résistives jusqu'à un maximum de 5A à 250Vca/30Vcc. La carte est automatiquement reconnue par l'outil qui habilite la visibilité et la programmation des paramètres appropriés.

BESCHREIBUNG

Diese Karte unterstützt die als OUT3 beim Instrument 401 vorgesehene Ausgangsfunktion. Sie eignet sich zum Steuern von ohmschen Lasten bis maximal 5A bei 250Vac/30Vdc. Das Gerät erkennt die Karte automatisch und aktiviert die Funktionen für die Anzeige und die Einstellung der entsprechenden Parameter.

PERFIL

Esta ficha soporta la función de salida prevista como OUT3 en el instrumento 401. Idónea para pilotar las cargas resistivas hasta un máximo de 5 A a 250 Vca/30 Vcc. La ficha es reconocida de modo automático por el instrumento, que habilita visibilidad y programación de los respectivos parámetros.

PERFIL

Esta placa suporta a função de saída prevista como OUT3 no instrumento 401. É indicada para pilotar cargas resistivas até um máximo de 5A a 250Vca/30Vcc. A placa é reconhecida automaticamente pelo instrumento, que habilita a visibilidade e configuração dos respectivos parâmetros.

DATI TECNICI

Relè a singolo contatto NO
 Corrente max 5A a 250Vac / 30Vdc $\cos\varphi = 1$
 Protezione MOV 275V 0,25W in parallelo al contatto
 È possibile ottenere il relè eccitato all'accensione tramite l'esecuzione del ponticello S1 e la rimozione della resistenza R4.

TECHNISCHE DATEN

Relais mit einem Schließer
 Max. Strom 5A bei 250Vac / 30Vdc $\cos\varphi = 1$
 MOV-Schutz 275V 0,25W parallel zum Kontakt
 Die Erregung des Relais bei der Einschaltung ist möglich, wenn man die Brücke S1 herstellt und den Widerstand R4 entfernt.

TECHNICAL DATA

Single-contact relay NO
 Max. current 5A at 250Vac / 30Vdc $\cos\varphi = 1$
 Protection MOV 275V 0,25W in parallel to contact
 The relay can be energized at power-up by installing jumper S1 and removing resistance R4.

DATOS TÉCNICOS

Relé de contacto único NA
 Corriente máx. 5A a 250Vca / 30Vcc $\cos\varphi = 1$
 Protección MOV 275 V 0,25 W en paralelo con contacto
 Es posible obtener la excitación del relé con el encendido mediante aplicación del puente S1 y remoción de la resistencia R4.

CARACTERISTIQUES TECHNIQUES

Relais à contact simple NO
 Courant maxi 5A à 250Vca / 30Vcc $\cos\varphi = 1$
 Protection MOV 275V 0,25W en parallèle au contact
 Il est possible d'obtenir le relais excité lors de la mise sous tension en exécutant le cavalier S1 et en retirant la résistance R4.

DADOS TÉCNICOS

Relé com contato único NA
 Corrente máx 5A a 250Vca / 30Vcc $\cos\varphi = 1$
 Proteção MOV 275V 0,25W em paralelo no contato
 É possível ter o relé excitado no momento de ligação, construindo a ponte S1 e removendo a resistência R4.

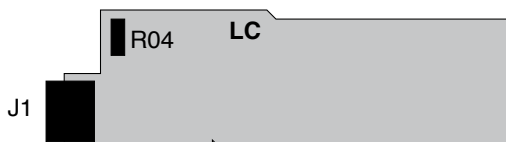

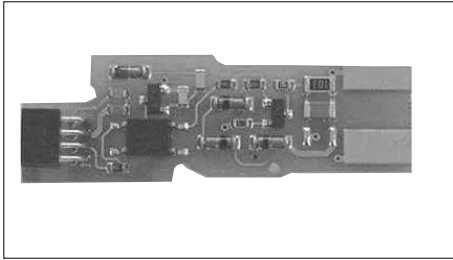

USCITA LOGICA (OUT3)
LOGIC OUTPUT (OUT3)
SORTIE LOGIQUE (OUT3)
LOGIKAUSGANG (OUT3)
SALIDA LÓGICA (OUT3)
SAÍDA LÓGICA (OUT3)

PROFILO

Questa scheda supporta la funzione di uscita prevista come OUT3 nello strumento 401.
Adatta a pilotare ingressi logici, applicazione tipica per interfaccia verso interruttori statici (GTS).
La scheda è automaticamente riconosciuta dallo strumento che abilita visibilità ed impostazione dei parametri relativi.

PROFILE

This board supports the output function provided as OUT3 on the 401 instrument.
Suitable for piloting logic inputs, typical application for interface to solid state switches (GTS).
The board is automatically recognized by the instrument, which enables display and setting of the parameters involved.

GENERALITES

Cette carte supporte la fonction sortie prévue comme OUT3 dans l'outil 401.
Elle est apte à piloter des entrées logiques, application typique pour l'interface vers des interrupteurs statiques (GTS).
La carte est automatiquement reconnue par l'outil qui habilite la visibilité et la programmation des paramètres appropriés.

BESCHREIBUNG

Diese Karte unterstützt die als OUT3 beim Instrument 401 vorgesehene Ausgangsfunktion.
Geeignet für die Steuerung von Logikeingängen, typische Anwendung für Schnittstelle zu Halbleiterrelais (GTS).
Das Gerät erkennt die Karte automatisch und aktiviert die Funktionen für die Anzeige und die Einstellung der entsprechenden Parameter.

PERFIL

Esta ficha soporta la función de salida prevista como OUT3 en el instrumento 401.
Idónea para pilotar entradas lógicas, aplicación típica para interfaz hacia interruptores estáticos (GTS).
La ficha es reconocida de modo automático por el instrumento, que habilita visibilidad y programación de los respectivos parámetros.

PERFIL

Esta placa suporta a função de saída prevista como OUT3 no instrumento 401.
É indicada para pilotar entradas lógicas, aplicação típica para interface versus interruptores estáticos (GTS).
A placa é reconhecida automaticamente pelo instrumento, que habilita a visibilidade e configuração dos respectivos parâmetros.

DATI TECNICI

24V ±10% (10V min a 20mA)
Limitazione di corrente a 30mA
È possibile pilotare direttamente gruppi statici GTS singolarmente o in serie per carichi trifase.

TECHNISCHE DATEN

24V ±10% (10V bei a 20mA)
Strombegrenzung auf 30mA
Die Halbleiterrelais GTS können direkt entweder einzeln oder in Reihe für dreiphasige Lasten gesteuert werden.

TECHNICAL DATA

24V ± 10 % (10V min at 20 mA)
Current limitation at 30mA
GTS solid state relays can be piloted directly, either individually or in series by three-phase loads.

DATOS TÉCNICOS

24V ±10% (10V mín. a 20mA)
Limitación de corriente a 30 mA
Es posible pilotar directamente grupos estáticos GTS de modo singular o en serie para cargas trifásicas.

CARACTERISTIQUES TECHNIQUES

24V ±10% (10V mini à 20mA)
Limitation de courant à 30mA
Il est possible de piloter directement des groupes statiques GTS individuellement ou en série, pour des charges triphasées.

DADOS TÉCNICOS

24V ±10% (10V mín a 20mA)
Limitação de corrente a 30 mA
É possível pilotar grupos estáticos, GTS, diretamente, individualmente ou em série, para cargas trifásicas.

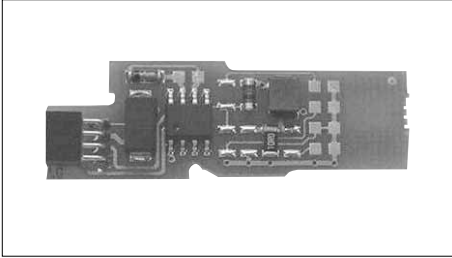

INGRESSO TA (OUT3)
CT INPUT (OUT3)
ENTREE TA (OUT3)
STROMWANDLER-EINGANG (OUT3)
ENTRADA TA (OUT3)
ENTRADA TA (OUT3)

PROFILO

Questa scheda supporta la funzione di ingresso da trasformatore amperometrico come alternativa ad OUT3 nello strumento 401.

La scheda è automaticamente riconosciuta dallo strumento che abilita visibilità ed impostazione dei parametri relativi.

PROFILE

This board supports the current transformer input function as alternative to OUT3 on the 401 instrument.

The board is automatically recognized by the instrument, which enables display and setting of the parameters involved.

GENERALITES

Cette carte supporte la fonction entrée depuis le transformateur ampèremétrique en tant qu'alternative à OUT3 dans l'outil 401.

La carte est automatiquement reconnue par l'outil qui habilite la visibilité et la programmation des paramètres appropriés.

BESCHREIBUNG

Die Karte unterstützt die Stromwandlereingangsfunktion als Alternative zum OUT3 des Geräts 401.

Das Gerät erkennt die Karte automatisch und aktiviert die Funktionen für die Anzeige und die Einstellung der entsprechenden Parameter.

PERFIL

Esta ficha soporta la función de entrada desde transformador amperimétrico como alternativa a OUT3 en el instrumento 401.

La ficha es reconocida de modo automático por el instrumento, que habilita visibilidad y programación de los respectivos parámetros.

PERFIL

Esta placa suporta a função de entrada de transformador amperométrico como alternativa de OUT3 no instrumento 401.

A placa é reconhecida automaticamente pelo instrumento, que habilita a visibilidade e configuração dos respectivos parâmetros.

DATI TECNICI

Ingresso 0...50mAac, 50/60Hz.

Resistenza ingresso: 10Ω

Accuratezza migliore dell'1% f.s. in assenza della calibrazione utente (ingresso 2 - custom TA) come descritto nel manuale d'uso.

TECHNISCHE DATEN

Eingang 0...50 mAac 50/60 Hz.

Eingangswiderstand: 10Ω

Genauigkeit besser als 1% v.Ew. ohne kundenspezifische Kalibration (Eingang 2 - kundenspezifischer Stromwandler und wie in der Bedienungsanleitung beschrieben).

TECHNICAL DATA

Input 0...50mAac, 50/60Hz.

Input resistance: 10Ω

Accuracy better than 1% f.s. in absence of user calibration (input 2 - custom CT and as described in the instruction manual).

DATOS TÉCNICOS

Entrada 0...50mAca, 50/60Hz.

Resistencia entrada: 10Ω

Precisión superior al 1 % f.s. si no se ejecuta la calibración usuario (entrada 2 - personalizada TA y de la manera ilustrada en el manual de uso).

CARACTERISTIQUES TECHNIQUES

Entrée 0...50mAca, 50/60Hz.

Résistance entrée: 10Ω

Précision supérieure à 1% p.e. en l'absence de l'étalonnage utilisateur (entrée 2 - sur mesure TA et comme décrit dans le Manuel Opérateur).

DADOS TÉCNICOS

Entrada 0...50mAca, 50/60Hz.

Resistência de entrada: 10Ω

Grau de precisão inferior a 1% do f.e. na ausência de calibração do usuário (entrada 2 - personalizada TA e como descrito no manual do usuário).