

# Using the LM3447-A19-230VEVM

## User's Guide



Literature Number: SLUU978  
June 2012



## WARNING

Always follow TI's set-up and application instructions, including use of all interface components within their recommended electrical rated voltage and power limits. Always use electrical safety precautions to help ensure your personal safety and the safety of those working around you. Contact TI's Product Information Center <http://support.ti.com> for further information.

**Save all warnings and instructions for future reference.**

**Failure to follow warnings and instructions may result in personal injury, property damage, or death due to electrical shock and/or burn hazards.**

The term TI HV EVM refers to an electronic device typically provided as an open framed, unenclosed printed circuit board assembly. It is intended strictly for use in development laboratory environments, solely for qualified professional users having training, expertise, and knowledge of electrical safety risks in development and application of high-voltage electrical circuits. Any other use and/or application are strictly prohibited by Texas Instruments. If you are not suitably qualified, you should immediately stop from further use of the HV EVM.

### 1. Work Area Safety:

- (a) Keep work area clean and orderly.
- (b) Qualified observer(s) must be present anytime circuits are energized.
- (c) Effective barriers and signage must be present in the area where the TI HV EVM and its interface electronics are energized, indicating operation of accessible high voltages may be present, for the purpose of protecting inadvertent access.
- (d) All interface circuits, power supplies, evaluation modules, instruments, meters, scopes and other related apparatus used in a development environment exceeding 50 V<sub>RMS</sub>/75 VDC must be electrically located within a protected Emergency Power Off (EPO) protected power strip.
- (e) Use a stable and non-conductive work surface.
- (f) Use adequately insulated clamps and wires to attach measurement probes and instruments. No freehand testing whenever possible.

### 2. Electrical Safety:

- (a) De-energize the TI HV EVM and all its inputs, outputs, and electrical loads before performing any electrical or other diagnostic measurements. Revalidate that TI HV EVM power has been safely de-energized.
- (b) With the EVM confirmed de-energized, proceed with required electrical circuit configurations, wiring, measurement equipment hook-ups and other application needs, while still assuming the EVM circuit and measuring instruments are electrically live.
- (c) Once EVM readiness is complete, energize the EVM as intended.

**WARNING: while the EVM is energized, never touch the EVM or its electrical circuits as they could be at high voltages capable of causing electrical shock hazard.**

### 3. Personal Safety:

- (a) Wear personal protective equipment e.g. latex gloves and/or safety glasses with side shields or protect EVM in an adequate lucent plastic box with interlocks from accidental touch.

### 4. Limitation for Safe Use:

- (a) EVMs are not to be used as all or part of a production unit.

# ***LM3447-A19-230VEVM is a Phase-Dimmable, Primary-Side Regulated LED Driver***

---

---

---

## **1 Introduction**

The LM3447-A19-230VEVM is a 10-W, 230-V<sub>AC</sub> isolated dimmable LED driver whose form factor intended for A19 and R27 applications.

## **2 Description**

The LM3447-A19-230VEVM is a primary-side power regulated PFC controller used for commercial and residential phase-cut dimmer compatible LED lamp drivers. The LM3447-A19-230VEVM uses fixed frequency valley switching operation resulting in discontinuous current operation.

### **2.1 Typical Applications**

- A19 Bulb Form Factor
- R27 Bulb Form Factor

### **2.2 Features**

- Primary-Side Control
- Leading and Trailing Edge Compatible
- 50:1 Dimming Range
- Valley Switching
- Fixed Frequency Discontinuous Operation
- Thermal Foldback
- PFC
- Efficient Triac Hold Current Operation
- LED Short and Open Circuit Detection
- Thermal Foldback
- Constant Power Operation

### 3 Electrical Performance Specifications

**Table 1. LM3447-A19-230VEVM Electrical Performance Specifications**

PARAMETER	TEST CONDITIONS	MIN	TYP	MAX	UNITS
<b>Input Characteristics</b>					
Voltage range		190	230	265	V
Maximum input current			50		mA
<b>Output Characteristics</b>					
Output voltage, $V_{OUT}$	9 to 10 LED's	28	30	32	V
Output load current, $I_{OUT}$		240	275	310	mA
Output current ripple	$V_{IN} = 230 V_{AC}$		100		mApp
Output over voltage			36		V
<b>Systems Characteristics</b>					
Switching frequency			75		kHz
Full-load efficiency	$V_{IN} = 230 V_{AC}$		82%		
Power factor, PF			0.98		

4 Schematic

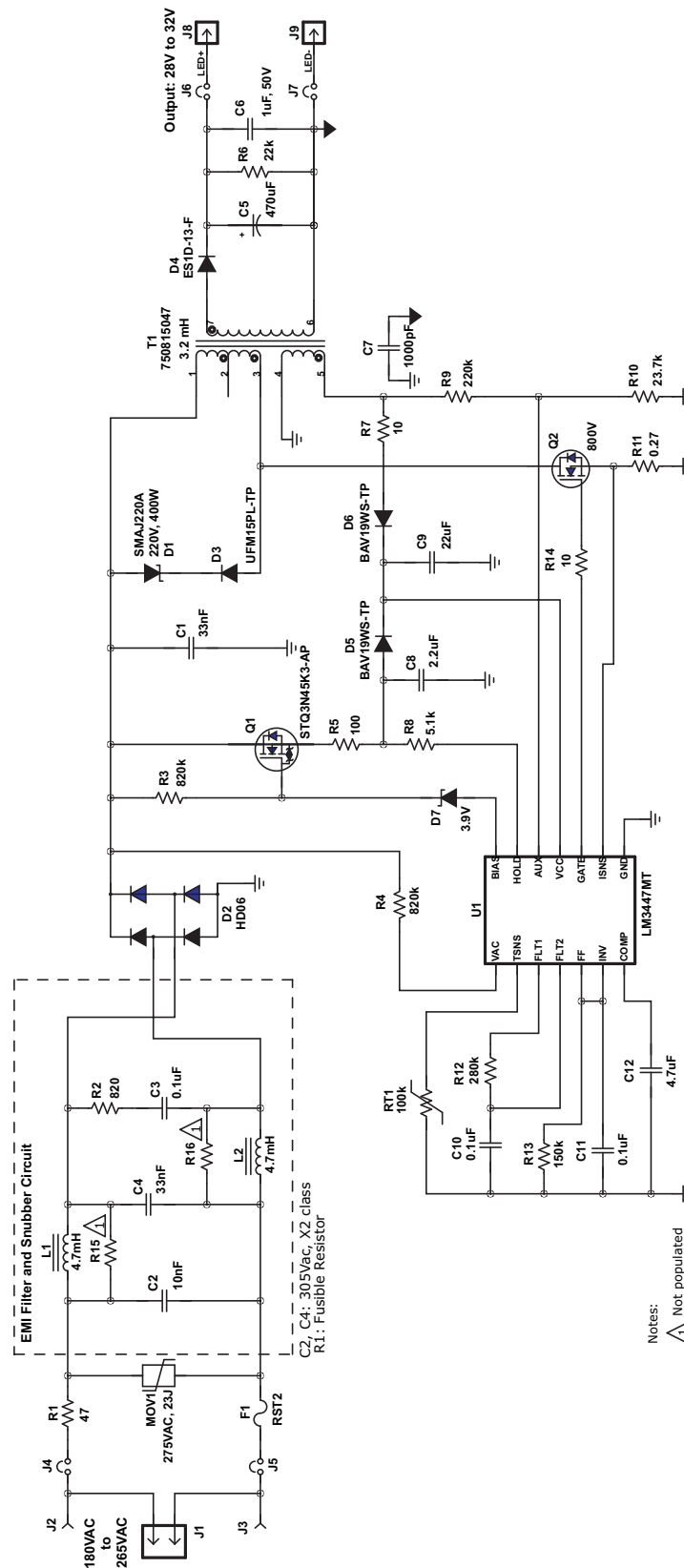

Figure 1. LM3447-A19-230VEVM Schematic

## 5 Test Setup

### 5.1 Test Equipment

**Voltage Source:** 190 V<sub>RMS</sub> to 265 V<sub>RMS</sub> isolated AC source PCR500LA (KIKUSUI)

**Multimeters:** Agilent 34401A

**Power Meter:** PM1000 Digital Power Meter (Voltech)

**Output Load:** 9 LEDs in series (VF = 3.2 V at 350 mA per LED)

**Oscilloscope:** TDS3045C (TEKTRONIX)

**Operating Temperature:** 25°C

**Recommended Wire Gauge:** 18 AWG not more than two feet long

### 5.2 Recommended Test Setup

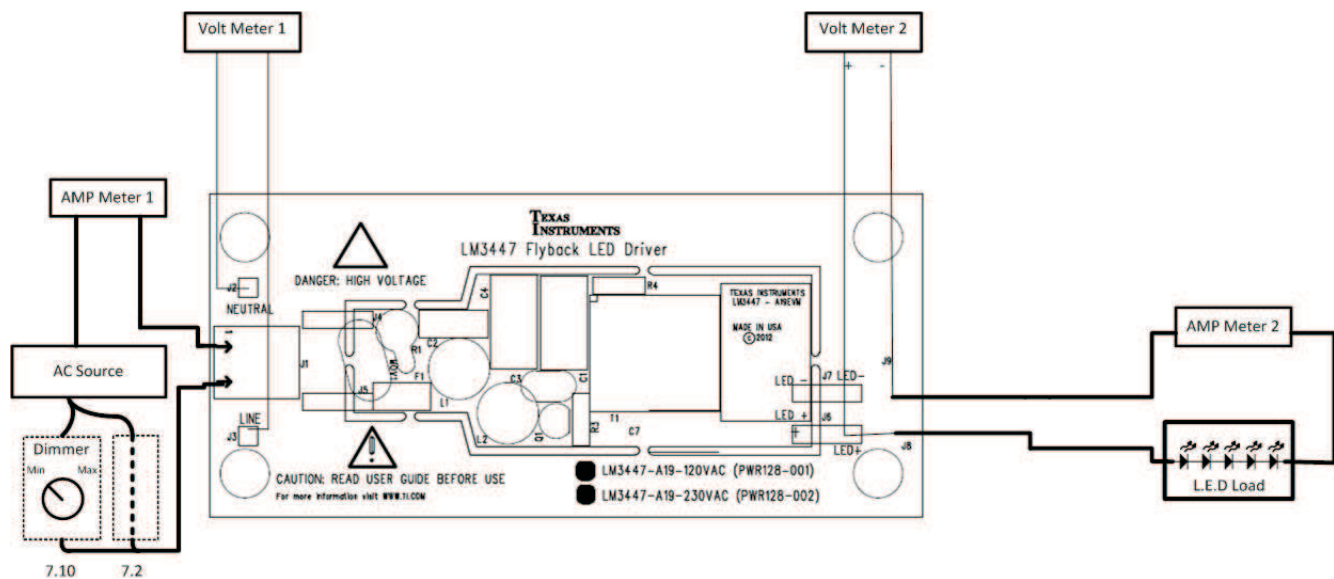

Figure 2. LM3447-A19-230VEVM Recommended Test Set Up

### 5.3 List of Test Points

Table 2. Test Points Functions

TEST POINTS	NAME	DESCRIPTION
TP1	Neutral	230 V <sub>AC</sub> neutral connection
TP2	Line	230 V <sub>AC</sub> line voltage
J8	LED+	LED anode connection
J9	LED-	LED cathode connection

## 6 Test Procedure

### 6.1 Line/Load Regulation and Efficiency Measurement Procedure

1. Connect EVM per [Figure 2](#) above. An external LED load must be used to start up the EVM.
2. Prior to turning on the AC source, set the voltage to 190 V<sub>RMS</sub>.
3. Turn on the AC source.
4. Record the output voltage and current readings from Voltmeter 2 and output current reading from Ammeter 2 and input voltage reading from Voltmeter 1 and current from Ammeter 1.
5. Increase output voltage by 5 V<sub>RMS</sub>.
6. Repeat steps 4 and 5 until 265 V<sub>AC</sub> is reached.
7. Refer to [Section 6.2](#) for shutdown procedure.

### 6.2 Equipment Shutdown

1. Turn off equipment.
2. Make sure capacitors are discharged.

### 6.3 EVM Phase Angle Decode vs LED Current

1. Connect EVM per [Figure 2](#) above. An external LED load must be used to start up the EVM.
2. Prior to turning on the AC source, set the voltage to 230 VRMS.
3. Connect scope probe to EVM per [Figure 2](#) above to bridge rectifier output.
4. Turn on the AC source.
5. Record the output voltage and current readings from Voltmeter 2 and output current reading from Ammeter 2 and input voltage reading from Voltmeter 1 and current from Ammeter 1.
6. Set dimmer to minimum setting and vary by 1.0 msec till 8 msec is reached and record in 5 above.
7. Refer to [Section 6.2](#) for shutdown procedure.

---

**NOTE:** The scope must be isolated.

---

## 7 Performance Data and Typical Characteristic Curves

Figure 3 through Figure 26 present typical performance curves for LM3447-A19-230VEVM.

### 7.1 Efficiency

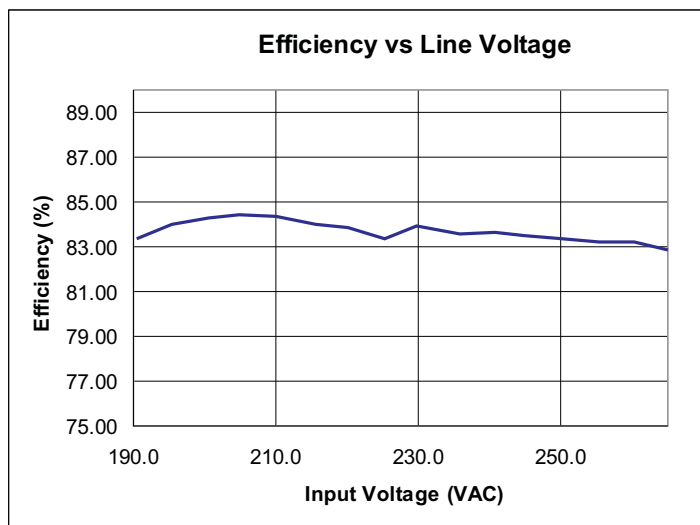

Figure 3. LM3447-A19-230VEVM Efficiency

### 7.2 Power Factor

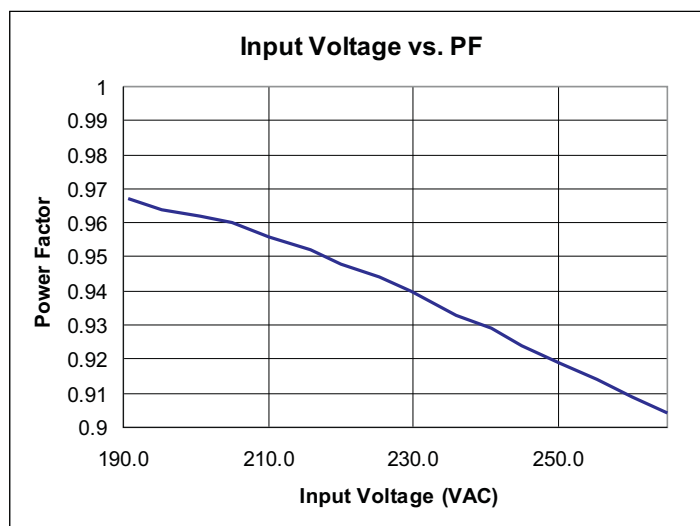

Figure 4. LM3447-A19-230VEVM Power Factor vs Line Voltage



### 7.3 Line Regulation

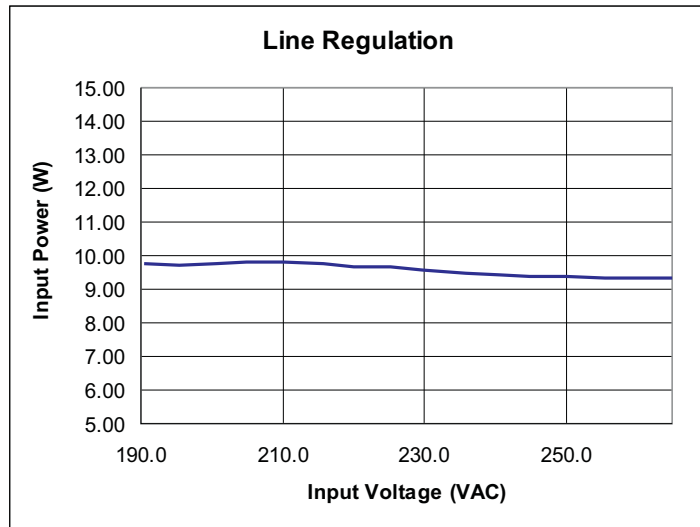

Figure 5. LM3447-A19-230VEVM Input Power Regulation

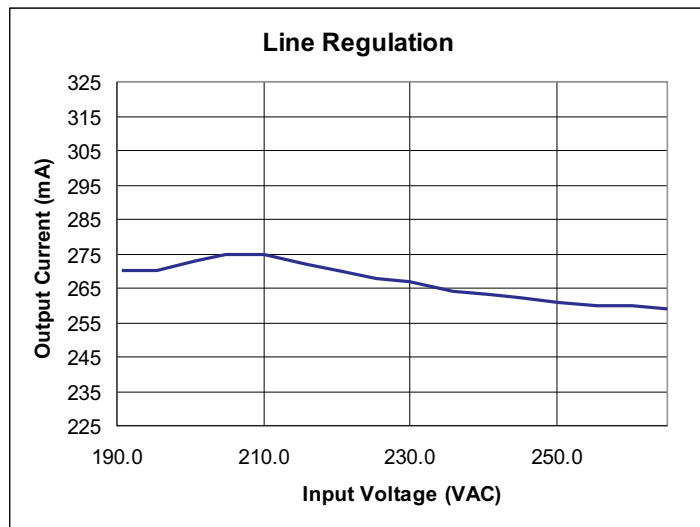

Figure 6. LM3447-A19-230VEVM LED Current Regulation

### 7.4 Input Current THD

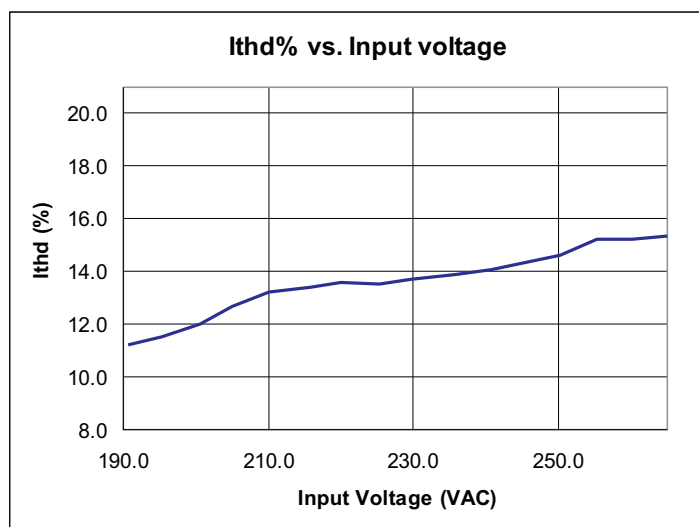

Figure 7. LM3447-A19-230VEVM- Ithd % vs Line Voltage

### 7.5 Output Ripple

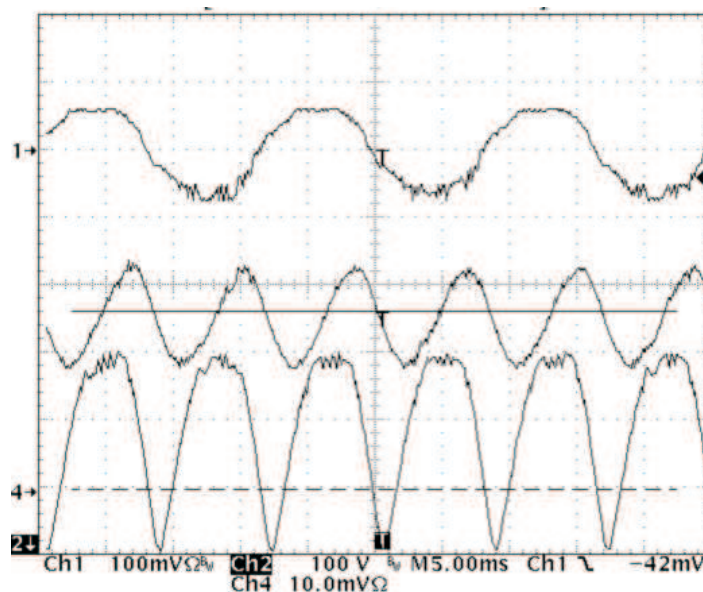

Figure 8. Output Ripple  
(Ch1 - line current Ch2 - rectified line voltage Ch4- LED current 100 mA/div)

### 7.6 Switch Node Voltage Valley Switching

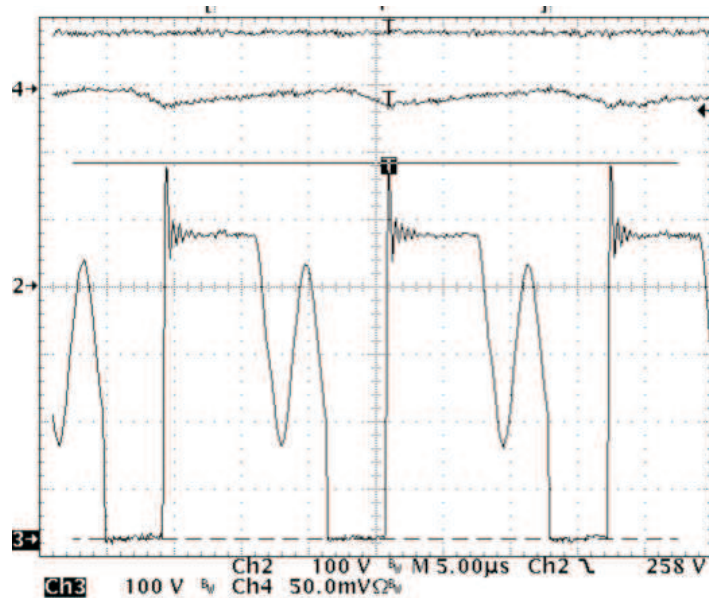

Figure 9. Switch Node Waveform  
(Ch4 - LED current Ch3 - switch node Ch2 - rectified line voltage)

### 7.7 Triac Dimmer LED Current vs Conduction Angle

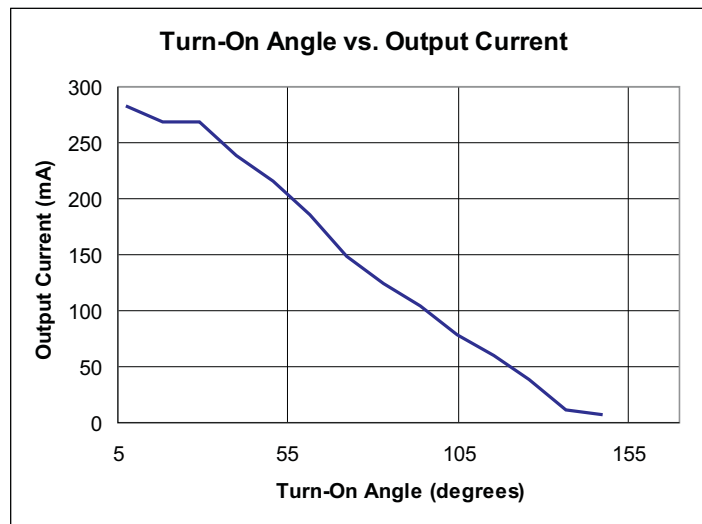

Figure 10. LED Current vs Conduction Angle

### 7.8 Turn-On Angle vs Input Power

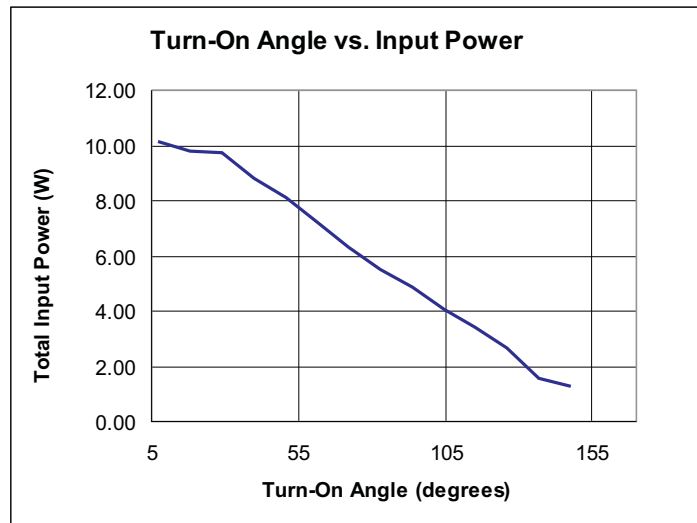

Figure 11. Turn-On Angle vs. Input Power

### 7.9 Input/Output Current and Line Voltage Waveforms vs. Dimmer Setting

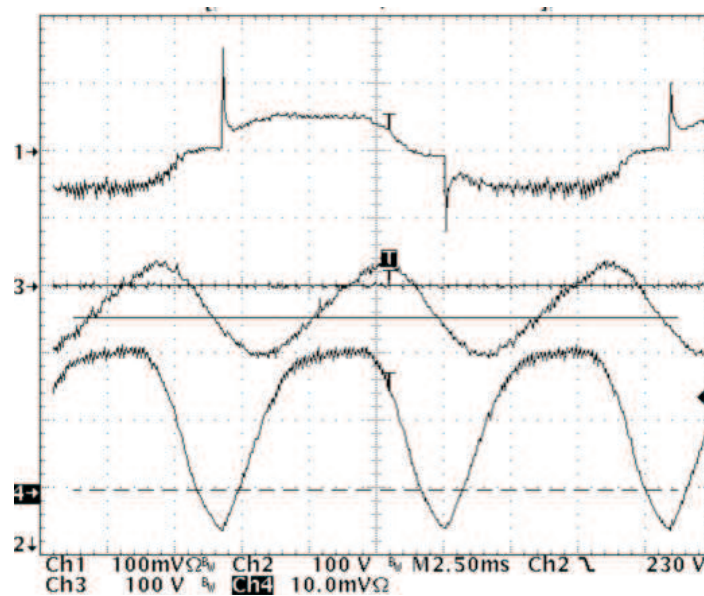

Figure 12. Dimmer Full On  
 (Ch1 - line current, Ch2 - rectified line voltage and Ch-4 LED current)

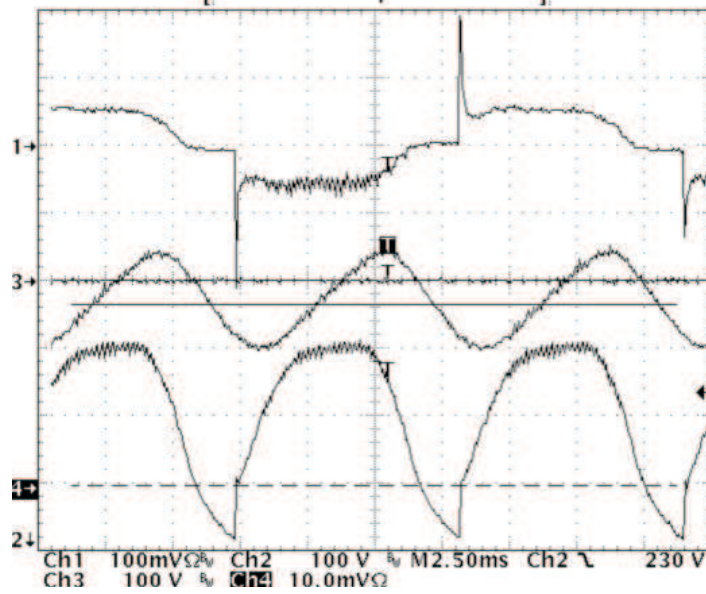

Figure 13. Dimmer 8 ms  
(Ch1 - line current, Ch-2 rectified line voltage and Ch4- LED current)

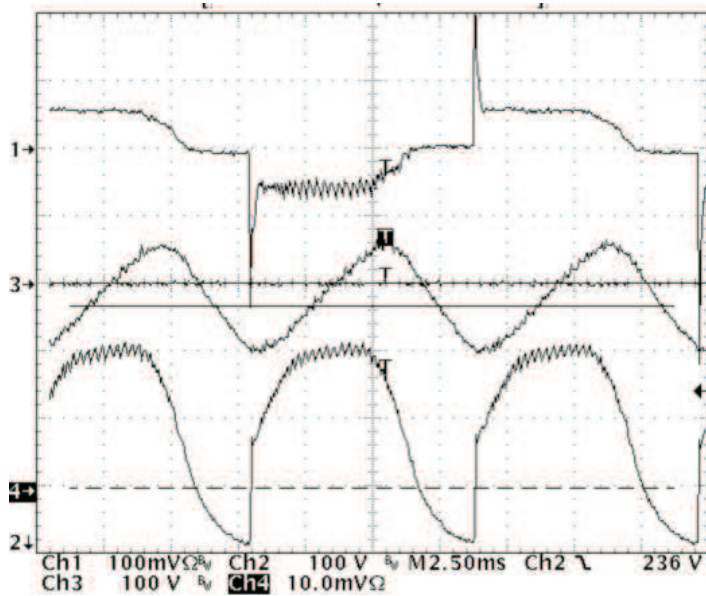

Figure 14. Dimmer 7 ms  
(Ch1 - line current, Ch2 - rectified line voltage and Ch4 - LED current)

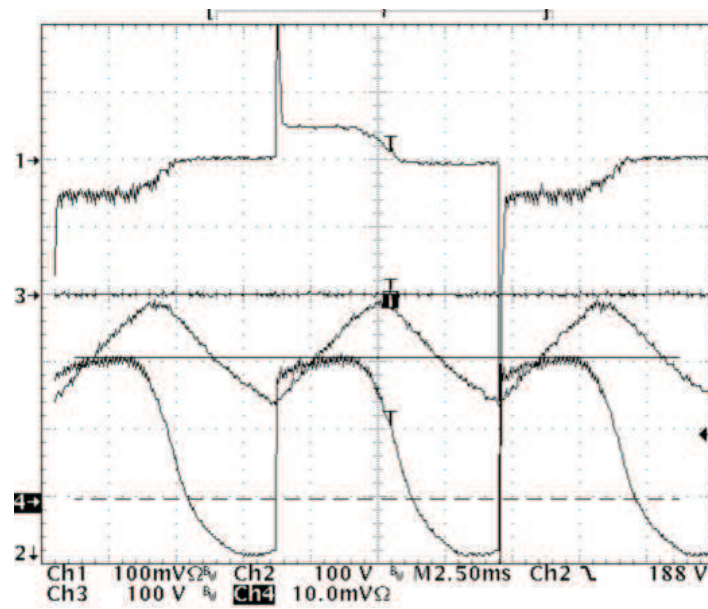

Figure 15. Dimmer 6 ms  
(Ch1 - line current, Ch2 - rectified line voltage and Ch4 - LED current)

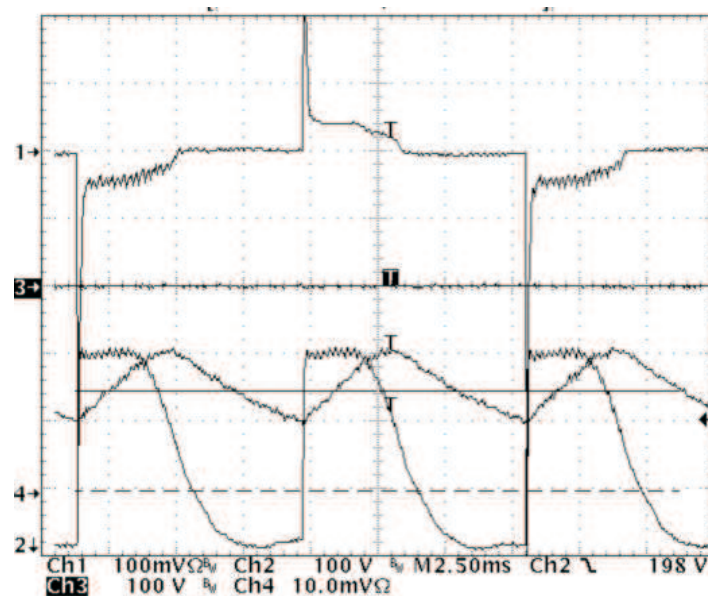

Figure 16. Dimmer 5 ms  
(Ch1 - line current, Ch2 - line voltage, Ch4- LED current)

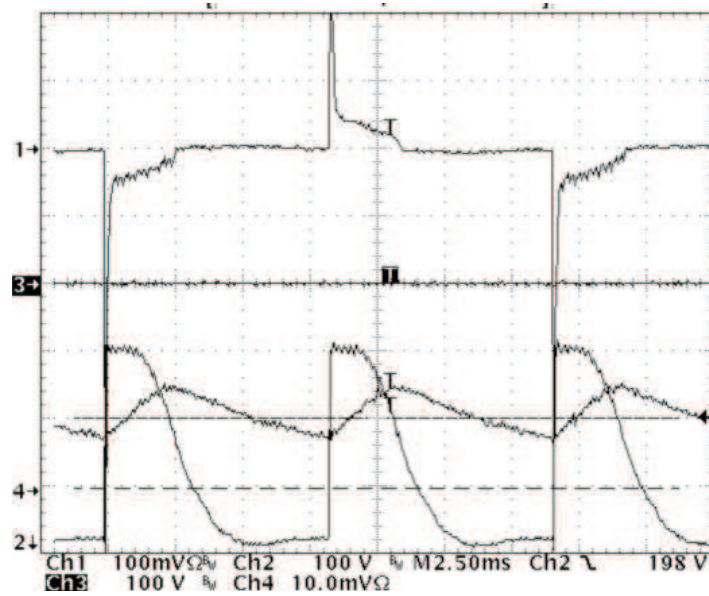

Figure 17. Dimmer 4 ms  
(Ch1 - line current, Ch2 - line voltage and Ch4 - LED current)

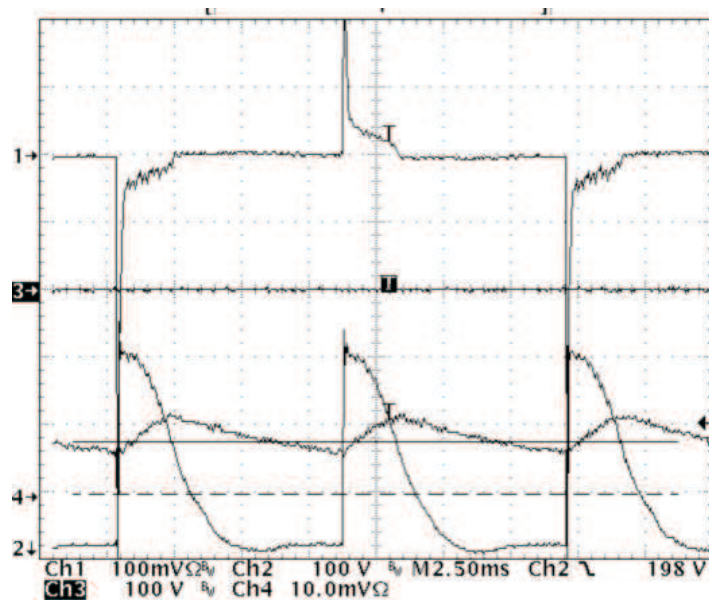
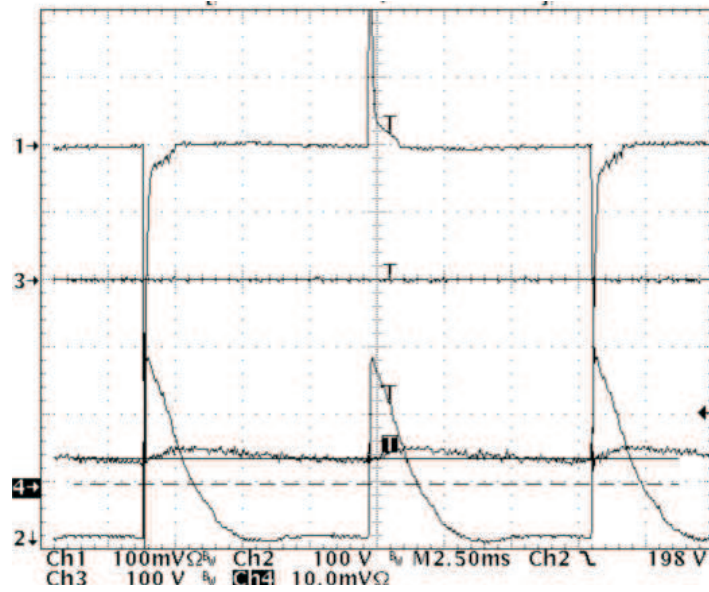
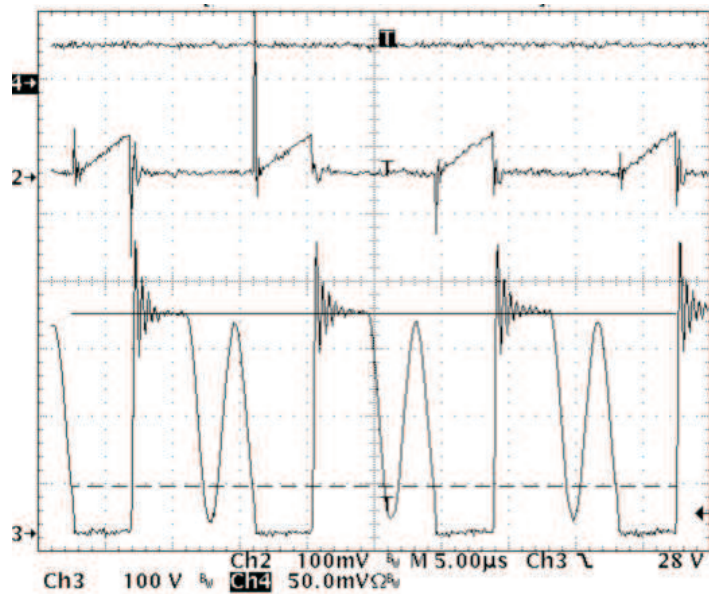

Figure 18. Dimmer 3 ms  
(Ch1 - line current, Ch2 - rectified line voltage, Ch4 - LED current)



**Figure 19. Dimmer 2.0 ms**  
(Ch1 - line current, Ch2 - rectified line voltage and Ch4 - LED current)

### 7.10 Current Sense Waveform



**Figure 20. Current Sense Waveform**  
(Ch2 - R11 current sense, Ch3 - switch node voltage and Ch4 - LED current)



**7.11 LED Open and Short Circuit Waveforms**

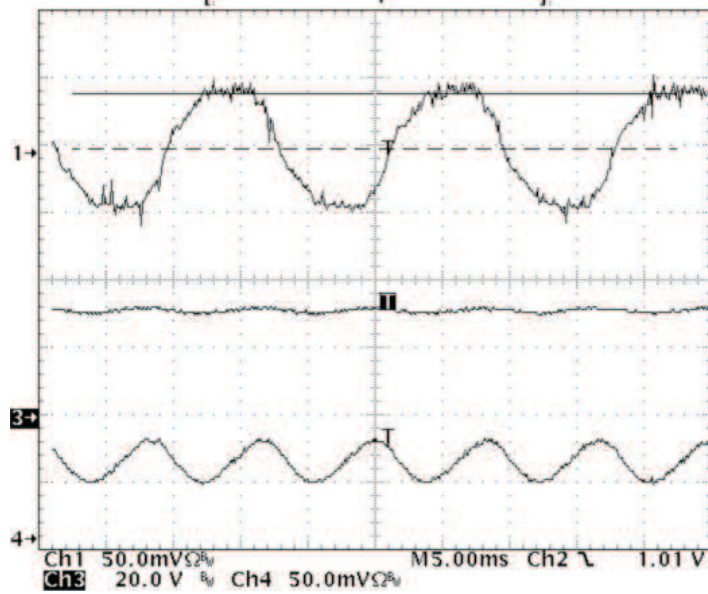

**Figure 21. Pre-Open Circuit Waveforms (Ch1 - line current, Ch3 - LED voltage and Ch4 - LED current)**

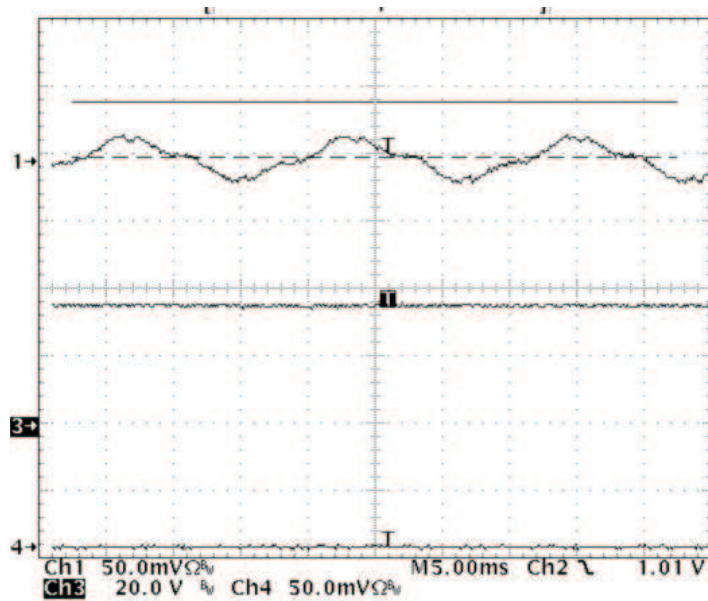

**Figure 22. Open Circuit Waveforms (Ch1 - line current Ch3 - LED voltage Ch4 - LED current)**

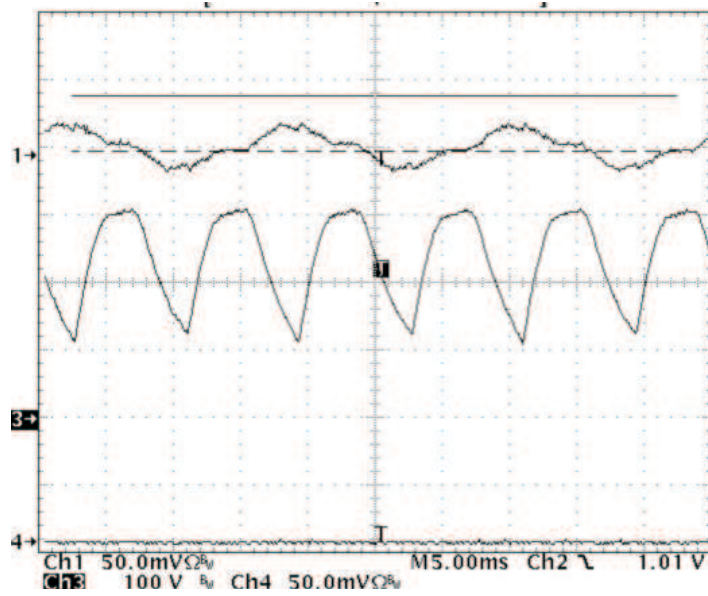

**Figure 23. Open Circuit Waveforms**  
(Ch1 - line current, Ch3 - rectified line voltage and Ch4 - LED current)

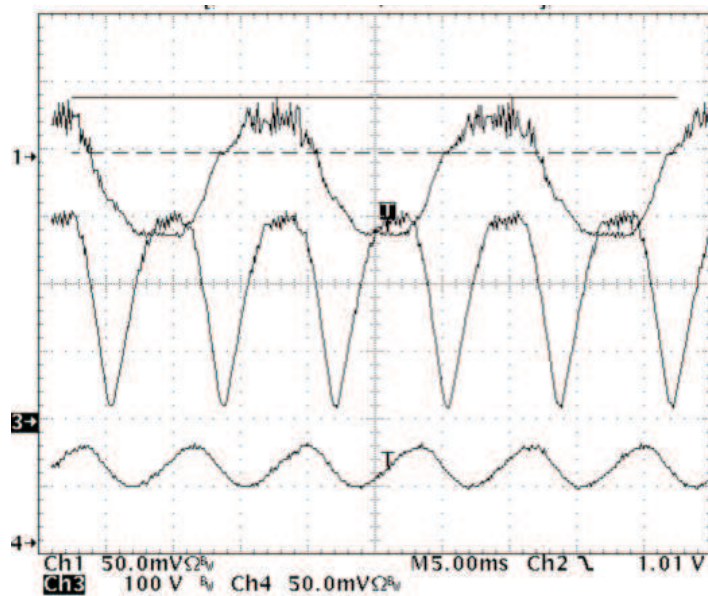

**Figure 24. Pre-Short Circuit Waveforms**  
(Ch1 - line current, Ch3 - rectified line voltage and Ch4 - LED current)

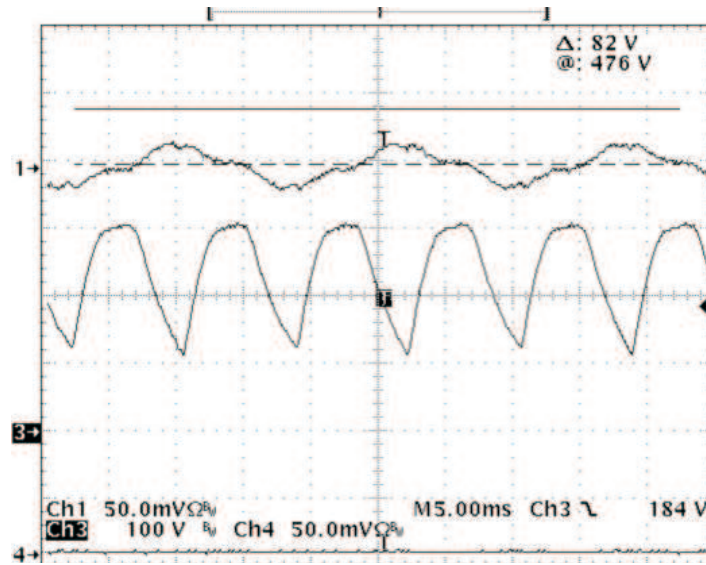

**Figure 25. Short Circuit Waveforms**  
 (Ch1 - line current, Ch3 - rectified line voltage and Ch4- LED current)

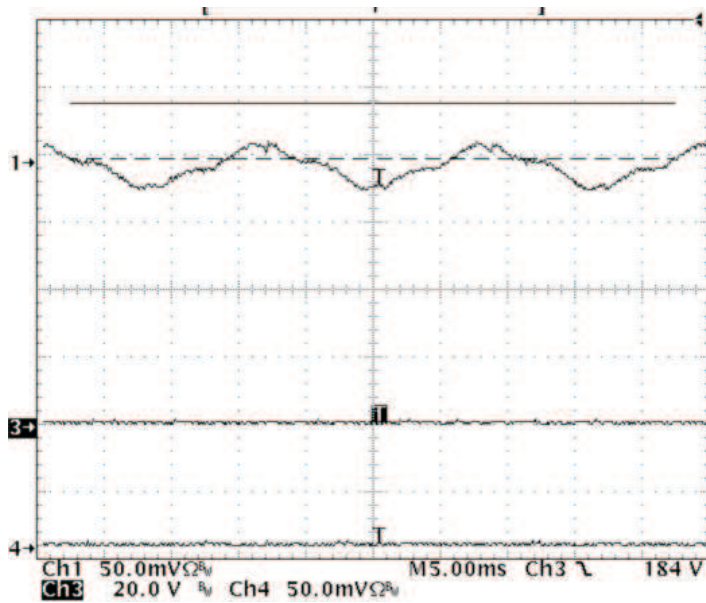

**Figure 26. Short Circuit Waveforms**  
 (Ch1 - line current, Ch3 - LED voltage and Ch4 - LED current)

7.12 EMI Plot

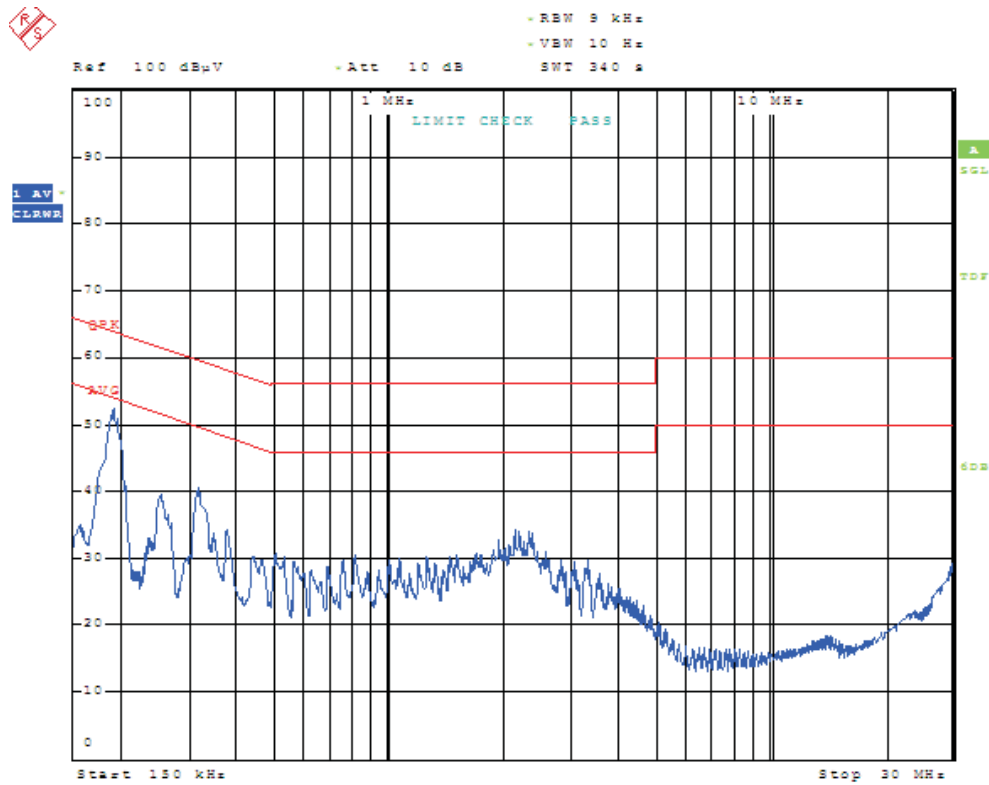

Figure 27. EMI Plot

### 7.13 Transformer Specification

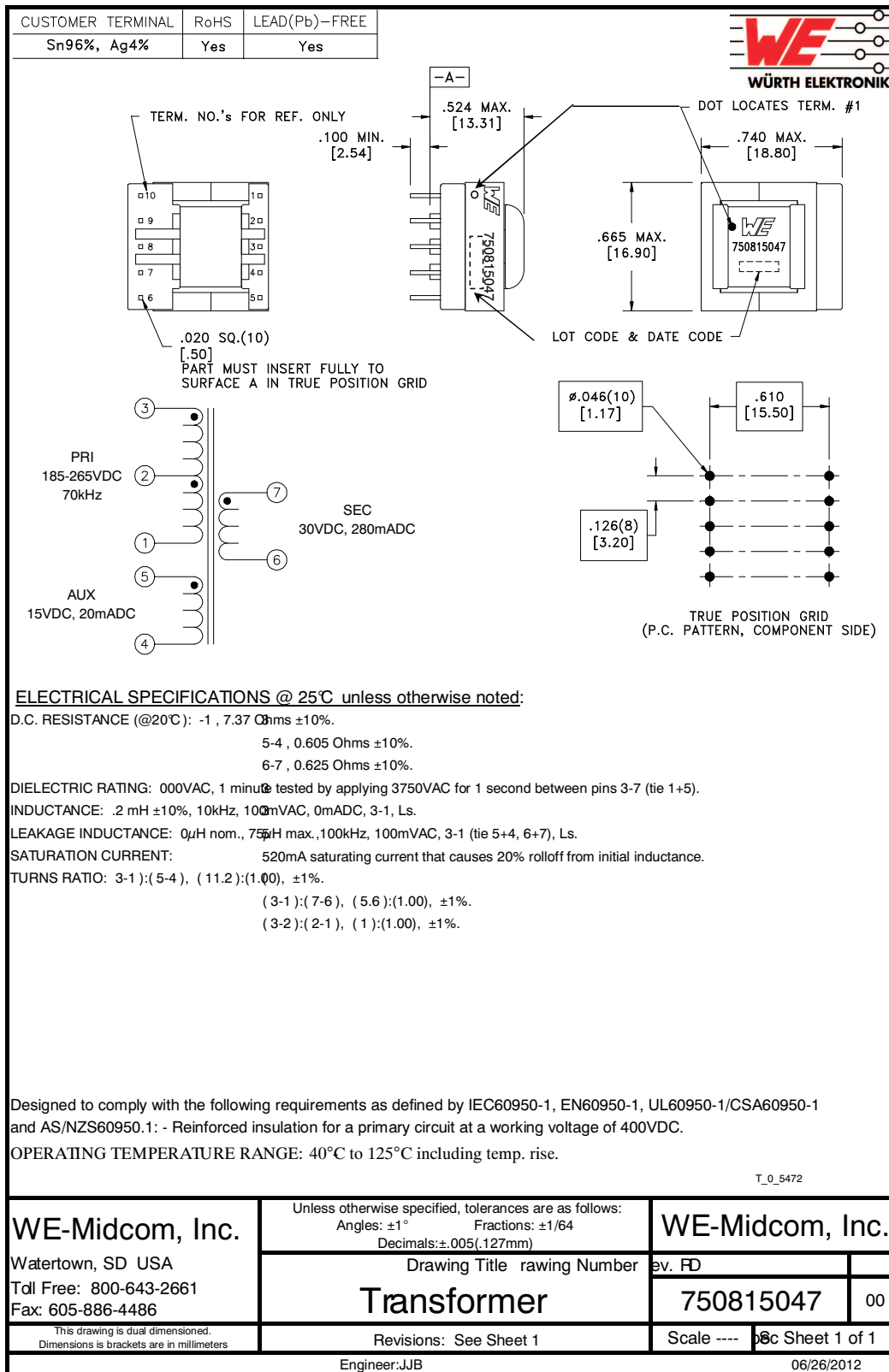
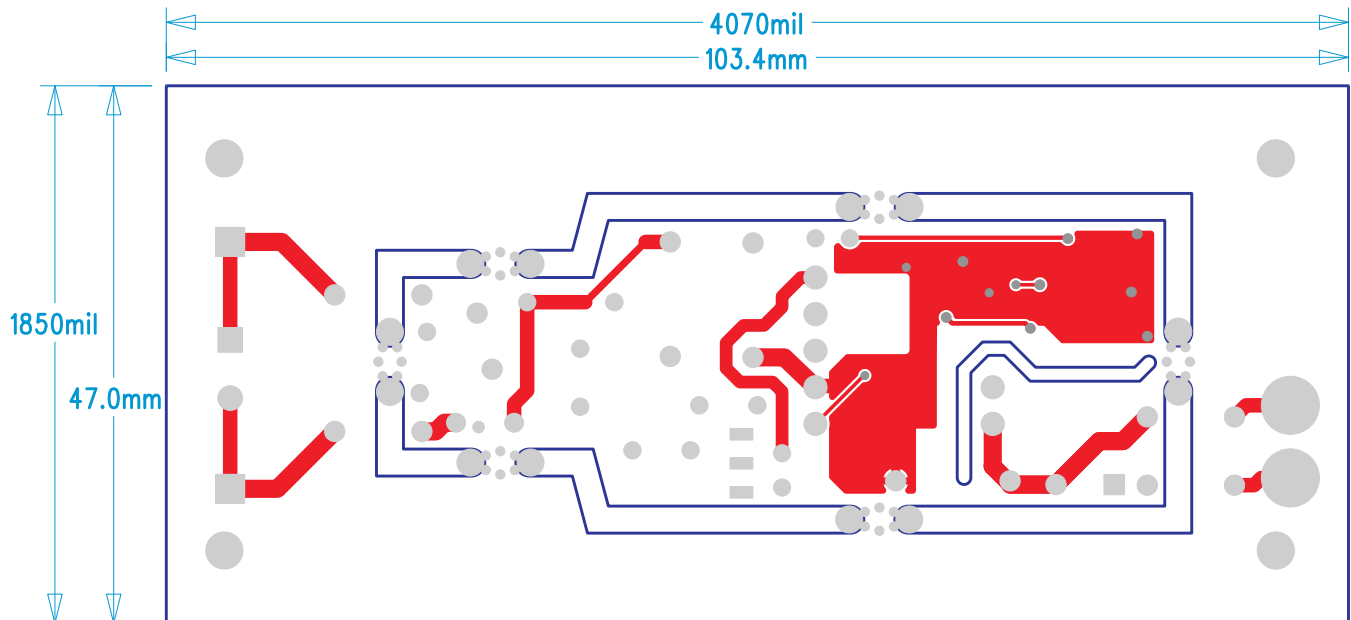

Figure 28. Transformer Specification

## 8 EVM Assembly Drawing and PCB Layout

The following figures (Figure 29 through Figure 32) show the design of the LM3447-A19-230VEVM printed circuit board.



**Figure 29. LM3447-A19-230VEVM Top Layer Copper (top view)**

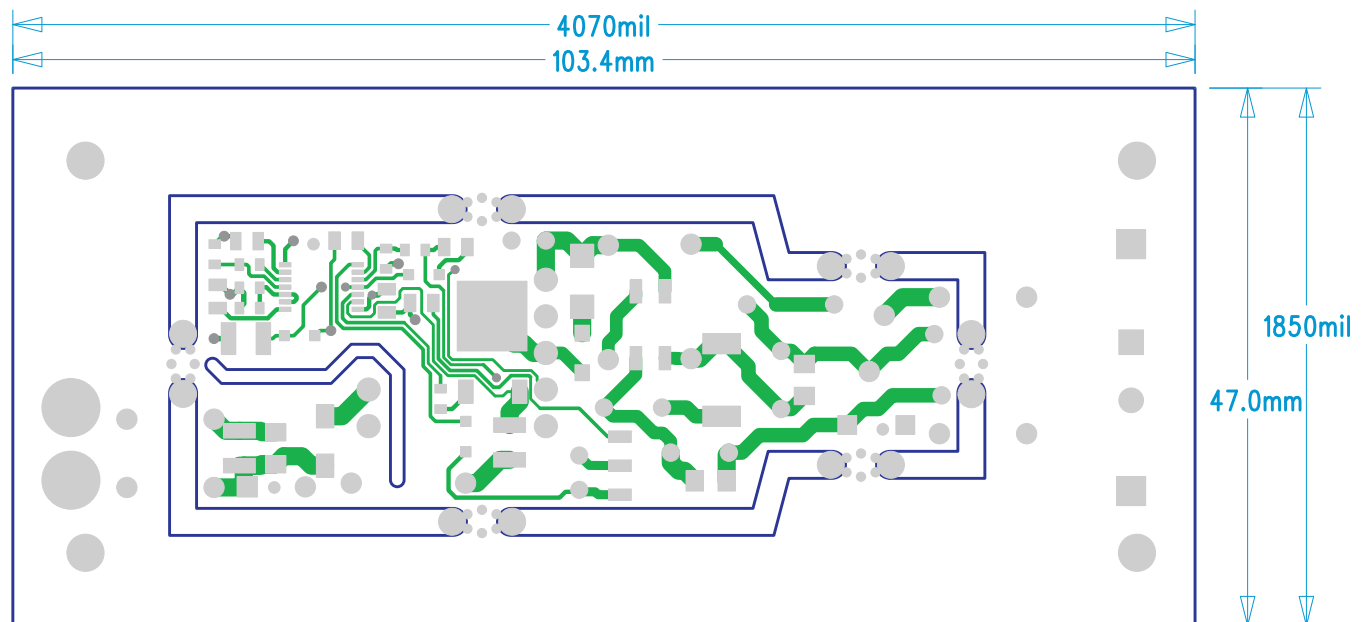

**Figure 30. LM3447-A19-230VEVM Bottom Layer Copper (bottom view)**

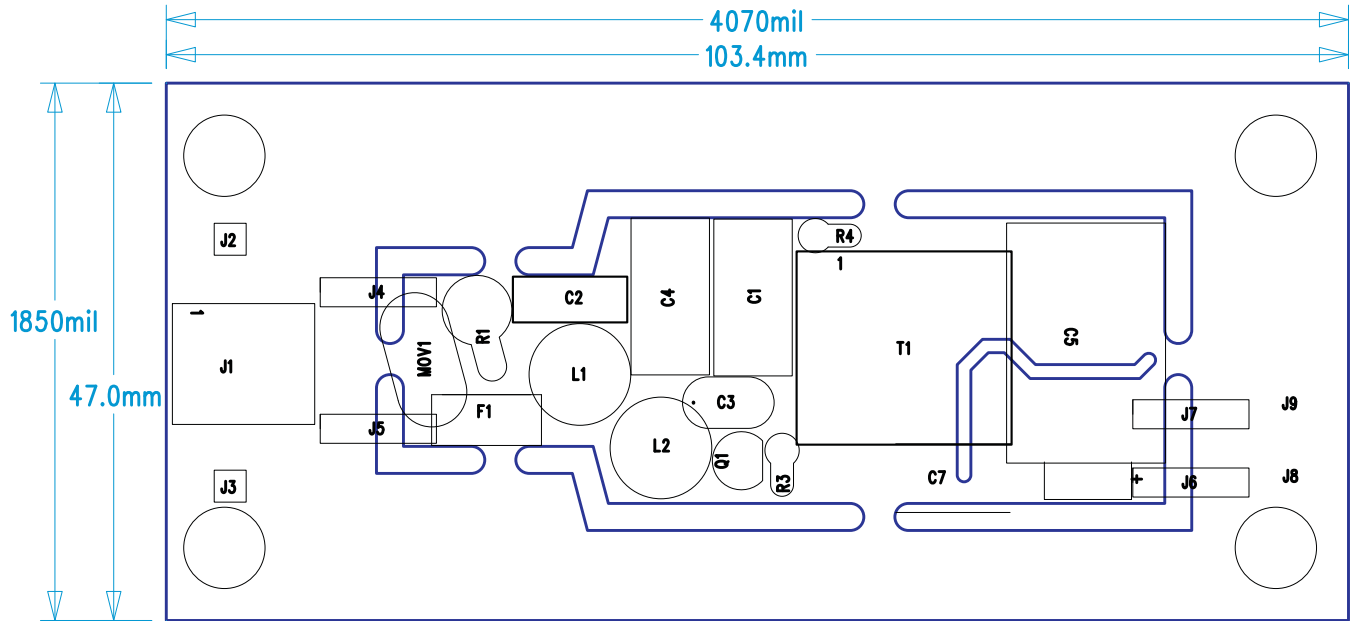

**Figure 31. LM3447-A19-230VEVM Top Assembly Drawing (top view)**

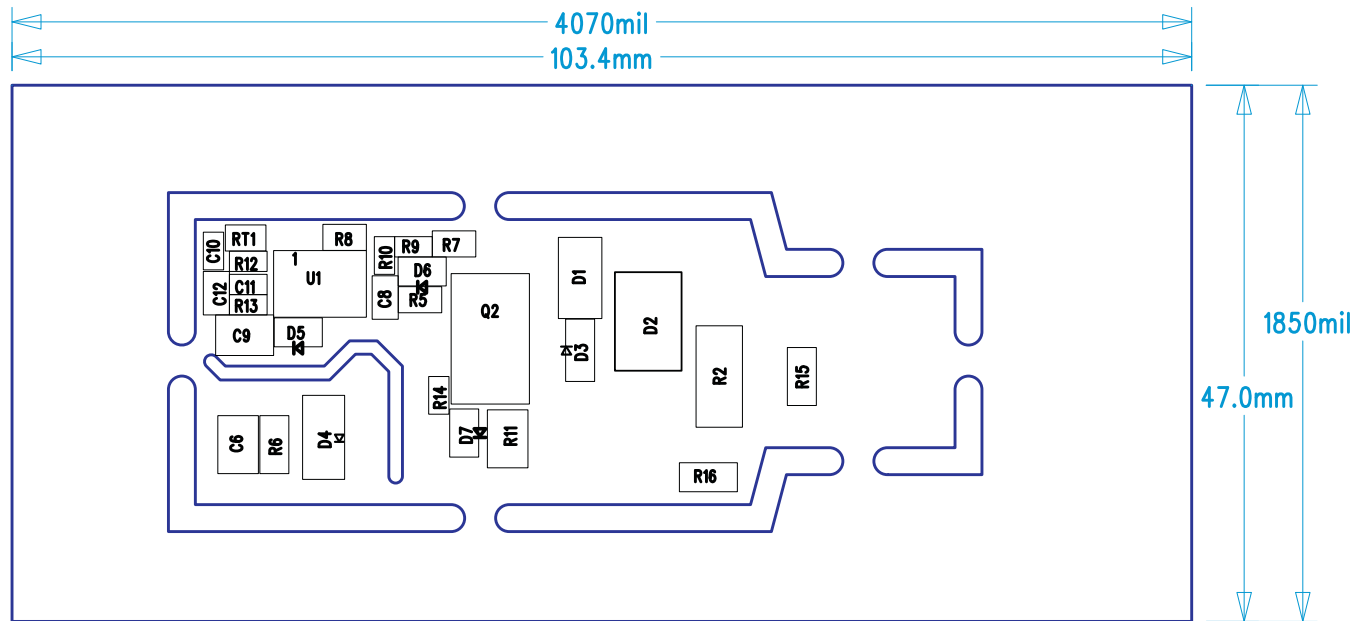

**Figure 32. LM3447-A19-230VEVM Bottom Assembly Drawing (bottom view)**

## 9 List of Materials

The EVM components list according to the schematic shown in [Figure 1](#).

**Table 3. LM3447-A19-230VEVM List of Materials**

QTY	REFDES	DESCRIPTION	MFR	PART NUMBER
2	C10,C11	Capacitor ceramic, 0.1 $\mu$ F, 16 V, 603	STD	STD
1	C12	Capacitor ceramic, 4.7 $\mu$ F, 16 V, 805	Murata	GCM21BR71C475KA73L
1	C6	Capacitor ceramic, 1.0 $\mu$ F, 1210	STD	STD
1	C7	Capacitor, 1000 pF, X1Y1, 250 V <sub>AC</sub>	TDK	CD85-E2GA102MYNS
1	C2	Capacitor film, 10 nF, 310 V <sub>AC</sub> , X2	Vishay/BC	BFC233820103
1	C5	Capacitor aluminum, 470 $\mu$ F 50V	Vishay/BC	MAL214651471E3
1	C4	Capacitor, 305 V <sub>AC</sub> , 33 nF	Epcos	B32921C3333M
1	C1	Capacitor, 0.033 $\mu$ F, leaded, 305 V <sub>AC</sub>	Epcos	B32921C3333M
1	C3	Capacitor, 0.1 $\mu$ F, 630 V	TDK	FK22X7R2J104K
1	D2	Bridge rectifier, 600 V, 0.8 A, HD04	Diodes, Inc	HD06-T
2	D5, D6	Diode, small signal, 250 mA, SOD-323	Micro Commercial	BAV19WS-TP
1	D3	Diode, SMD ultrafast rectifier 1 A, 600 V	Micro Commercial	UFM15PL-TP
1	D4	Diode, super fast rectifier,	Diodes, Inc	ES1D
1	D7	Diode, Zener, 3.9 V, 200 mW, SOD-323	On Semi	MM3Z23V9T1G
1	D1	Diode, SMT TVS 400 W, 220 V	Littlefuse	SMAJ220A
1	F1	Fuse, slow, 250 V <sub>AC</sub> , 2 A, radial	Bel Fuse inc	RST2
2	L1,L2	Inductor, EMI, 240 mA, 4.7 mH	Bourns	RLB9012-472KL
1	MOV1	MOV, V <sub>MAX</sub> , 275 V <sub>DC</sub> , 23j 7 mm Radial	Littelfuse Inc	V275LA4P
1	R14	Resistor, chip, 10 $\Omega$ , 1/16 W, 603	STD	STD
1	R13	Resistor, chip, 118 k $\Omega$ , 1/16 W, 603	STD	STD
1	R9	Resistor, chip, 220 k $\Omega$ , 1/16 W, 603	STD	STD
1	R10	Resistor, chip, 23.7 k $\Omega$ , 1/16 W, 603	STD	STD
1	R12	Resistor, chip, 280 k $\Omega$ , 1/16W, 603	STD	STD
2	R3,R4	Resistor, chip, 430 k $\Omega$ , 0.25 W, 1%	Vishay Dale	HVR2500004303F, R500
1	R1	Resistor, Fusible, 47 $\Omega$ , 2 W, 5%	Welwyn	EMC-47RKI
1	R7	Resistor, chip, 10 $\Omega$ , 1/10 W, $\pm$ 5% 805	STD	STD
1	R5	Resistor, chip, 100 $\Omega$ , 1/10 W, $\pm$ 5% 805	STD	STD
1	R8	Resistor, chip, 5.1 k $\Omega$ , 1/10 W, $\pm$ 5% 805	STD	STD
DNP	R15,R16	Resistor, chip, 10 k $\Omega$ , 1/4 W, $\pm$ 5% 1206	STD	STD
1	R6	Resistor, chip, 22 k $\Omega$ , 1/4 W, $\pm$ 5% 1206	STD	STD
1	R11	Resistor, chip, 0.27 $\Omega$ , 1/2 W, 1210	Vishay Dale	RCWL1210R270JNE A
1	R8	Resistor, chip, 820 $\Omega$ , 1.5 W, 5%, 2512	Vishay Dale	CRCW2512820RJ, NEG
1	RT1	"Thermistor, NTC, 100 k $\Omega$ , 0805	Murata	NCP21WF104J03RA
1	Q2	MOSFET, N-channel, 800 V, 3 A, 3.5 $\Omega$ , DPAK	ST Micro	STD4NK80ZT4
1	Q1	MOSFET, 450 V, 600 mA, 2 W	ST Micro	STQ3N45K3-AP
1	U1	Dimmable LED Controller TSSOP	TI	LM3447MT
	T1	EE16, 3.2 mH, 5.6:1	Würth	750813047



## Evaluation Board/Kit Important Notice

Texas Instruments (TI) provides the enclosed product(s) under the following conditions:

This evaluation board/kit is intended for use for **ENGINEERING DEVELOPMENT, DEMONSTRATION, OR EVALUATION PURPOSES ONLY** and is not considered by TI to be a finished end-product fit for general consumer use. Persons handling the product(s) must have electronics training and observe good engineering practice standards. As such, the goods being provided are not intended to be complete in terms of required design-, marketing-, and/or manufacturing-related protective considerations, including product safety and environmental measures typically found in end products that incorporate such semiconductor components or circuit boards. This evaluation board/kit does not fall within the scope of the European Union directives regarding electromagnetic compatibility, restricted substances (RoHS), recycling (WEEE), FCC, CE or UL, and therefore may not meet the technical requirements of these directives or other related directives.

Should this evaluation board/kit not meet the specifications indicated in the User's Guide, the board/kit may be returned within 30 days from the date of delivery for a full refund. **THE FOREGOING WARRANTY IS THE EXCLUSIVE WARRANTY MADE BY SELLER TO BUYER AND IS IN LIEU OF ALL OTHER WARRANTIES, EXPRESSED, IMPLIED, OR STATUTORY, INCLUDING ANY WARRANTY OF MERCHANTABILITY OR FITNESS FOR ANY PARTICULAR PURPOSE.**

The user assumes all responsibility and liability for proper and safe handling of the goods. Further, the user indemnifies TI from all claims arising from the handling or use of the goods. Due to the open construction of the product, it is the user's responsibility to take any and all appropriate precautions with regard to electrostatic discharge.

**EXCEPT TO THE EXTENT OF THE INDEMNITY SET FORTH ABOVE, NEITHER PARTY SHALL BE LIABLE TO THE OTHER FOR ANY INDIRECT, SPECIAL, INCIDENTAL, OR CONSEQUENTIAL DAMAGES.**

TI currently deals with a variety of customers for products, and therefore our arrangement with the user **is not exclusive.**

TI assumes **no liability for applications assistance, customer product design, software performance, or infringement of patents or services described herein.**

Please read the User's Guide and, specifically, the Warnings and Restrictions notice in the User's Guide prior to handling the product. This notice contains important safety information about temperatures and voltages. For additional information on TI's environmental and/or safety programs, please contact the TI application engineer or visit [www.ti.com/esh](http://www.ti.com/esh).

No license is granted under any patent right or other intellectual property right of TI covering or relating to any machine, process, or combination in which such TI products or services might be or are used.

## FCC Warning

This evaluation board/kit is intended for use for **ENGINEERING DEVELOPMENT, DEMONSTRATION, OR EVALUATION PURPOSES ONLY** and is not considered by TI to be a finished end-product fit for general consumer use. It generates, uses, and can radiate radio frequency energy and has not been tested for compliance with the limits of computing devices pursuant to part 15 of FCC rules, which are designed to provide reasonable protection against radio frequency interference. Operation of this equipment in other environments may cause interference with radio communications, in which case the user at his own expense will be required to take whatever measures may be required to correct this interference.

## EVM Warnings and Restrictions

It is important to operate this EVM within the input voltage range of 190 V to 265 V and the output voltage range of 26 V to 34 V.

Exceeding the specified input range may cause unexpected operation and/or irreversible damage to the EVM. If there are questions concerning the input range, please contact a TI field representative prior to connecting the input power.

Applying loads outside of the specified output range may result in unintended operation and/or possible permanent damage to the EVM. Please consult the EVM User's Guide prior to connecting any load to the EVM output. If there is uncertainty as to the load specification, please contact a TI field representative.

During normal operation, some circuit components may have case temperatures greater than 90°C. The EVM is designed to operate properly with certain components above 90°C as long as the input and output ranges are maintained. These components include but are not limited to linear regulators, switching transistors, pass transistors, and current sense resistors. These types of devices can be identified using the EVM schematic located in the EVM User's Guide. When placing measurement probes near these devices during operation, please be aware that these devices may be very warm to the touch.

Mailing Address: Texas Instruments, Post Office Box 655303, Dallas, Texas 75265  
Copyright © 2012, Texas Instruments Incorporated

## EVALUATION BOARD/KIT/MODULE (EVM) ADDITIONAL TERMS

Texas Instruments (TI) provides the enclosed Evaluation Board/Kit/Module (EVM) under the following conditions:

The user assumes all responsibility and liability for proper and safe handling of the goods. Further, the user indemnifies TI from all claims arising from the handling or use of the goods.

Should this evaluation board/kit not meet the specifications indicated in the User's Guide, the board/kit may be returned within 30 days from the date of delivery for a full refund. THE FOREGOING LIMITED WARRANTY IS THE EXCLUSIVE WARRANTY MADE BY SELLER TO BUYER AND IS IN LIEU OF ALL OTHER WARRANTIES, EXPRESSED, IMPLIED, OR STATUTORY, INCLUDING ANY WARRANTY OF MERCHANTABILITY OR FITNESS FOR ANY PARTICULAR PURPOSE. EXCEPT TO THE EXTENT OF THE INDEMNITY SET FORTH ABOVE, NEITHER PARTY SHALL BE LIABLE TO THE OTHER FOR ANY INDIRECT, SPECIAL, INCIDENTAL, OR CONSEQUENTIAL DAMAGES.

Please read the User's Guide and, specifically, the Warnings and Restrictions notice in the User's Guide prior to handling the product. This notice contains important safety information about temperatures and voltages. For additional information on TI's environmental and/or safety programs, please visit [www.ti.com/esh](http://www.ti.com/esh) or contact TI.

No license is granted under any patent right or other intellectual property right of TI covering or relating to any machine, process, or combination in which such TI products or services might be or are used. TI currently deals with a variety of customers for products, and therefore our arrangement with the user is not exclusive. TI assumes no liability for applications assistance, customer product design, software performance, or infringement of patents or services described herein.

## REGULATORY COMPLIANCE INFORMATION

As noted in the EVM User's Guide and/or EVM itself, this EVM and/or accompanying hardware may or may not be subject to the Federal Communications Commission (FCC) and Industry Canada (IC) rules.

For EVMs **not** subject to the above rules, this evaluation board/kit/module is intended for use for ENGINEERING DEVELOPMENT, DEMONSTRATION OR EVALUATION PURPOSES ONLY and is not considered by TI to be a finished end product fit for general consumer use. It generates, uses, and can radiate radio frequency energy and has not been tested for compliance with the limits of computing devices pursuant to part 15 of FCC or ICES-003 rules, which are designed to provide reasonable protection against radio frequency interference. Operation of the equipment may cause interference with radio communications, in which case the user at his own expense will be required to take whatever measures may be required to correct this interference.

### General Statement for EVMs including a radio

*User Power/Frequency Use Obligations:* This radio is intended for development/professional use only in legally allocated frequency and power limits. Any use of radio frequencies and/or power availability of this EVM and its development application(s) must comply with local laws governing radio spectrum allocation and power limits for this evaluation module. It is the user's sole responsibility to only operate this radio in legally acceptable frequency space and within legally mandated power limitations. Any exceptions to this are strictly prohibited and unauthorized by Texas Instruments unless user has obtained appropriate experimental/development licenses from local regulatory authorities, which is responsibility of user including its acceptable authorization.

### For EVMs annotated as FCC – FEDERAL COMMUNICATIONS COMMISSION Part 15 Compliant

#### Caution

This device complies with part 15 of the FCC Rules. Operation is subject to the following two conditions: (1) This device may not cause harmful interference, and (2) this device must accept any interference received, including interference that may cause undesired operation.

Changes or modifications not expressly approved by the party responsible for compliance could void the user's authority to operate the equipment.

### FCC Interference Statement for Class A EVM devices

This equipment has been tested and found to comply with the limits for a Class A digital device, pursuant to part 15 of the FCC Rules. These limits are designed to provide reasonable protection against harmful interference when the equipment is operated in a commercial environment. This equipment generates, uses, and can radiate radio frequency energy and, if not installed and used in accordance with the instruction manual, may cause harmful interference to radio communications. Operation of this equipment in a residential area is likely to cause harmful interference in which case the user will be required to correct the interference at his own expense.

### **FCC Interference Statement for Class B EVM devices**

This equipment has been tested and found to comply with the limits for a Class B digital device, pursuant to part 15 of the FCC Rules. These limits are designed to provide reasonable protection against harmful interference in a residential installation. This equipment generates, uses and can radiate radio frequency energy and, if not installed and used in accordance with the instructions, may cause harmful interference to radio communications. However, there is no guarantee that interference will not occur in a particular installation. If this equipment does cause harmful interference to radio or television reception, which can be determined by turning the equipment off and on, the user is encouraged to try to correct the interference by one or more of the following measures:

- Reorient or relocate the receiving antenna.
- Increase the separation between the equipment and receiver.
- Connect the equipment into an outlet on a circuit different from that to which the receiver is connected.
- Consult the dealer or an experienced radio/TV technician for help.

### **For EVMs annotated as IC – INDUSTRY CANADA Compliant**

This Class A or B digital apparatus complies with Canadian ICES-003.

Changes or modifications not expressly approved by the party responsible for compliance could void the user's authority to operate the equipment.

### **Concerning EVMs including radio transmitters**

This device complies with Industry Canada licence-exempt RSS standard(s). Operation is subject to the following two conditions: (1) this device may not cause interference, and (2) this device must accept any interference, including interference that may cause undesired operation of the device.

### **Concerning EVMs including detachable antennas**

Under Industry Canada regulations, this radio transmitter may only operate using an antenna of a type and maximum (or lesser) gain approved for the transmitter by Industry Canada. To reduce potential radio interference to other users, the antenna type and its gain should be so chosen that the equivalent isotropically radiated power (e.i.r.p.) is not more than that necessary for successful communication.

This radio transmitter has been approved by Industry Canada to operate with the antenna types listed in the user guide with the maximum permissible gain and required antenna impedance for each antenna type indicated. Antenna types not included in this list, having a gain greater than the maximum gain indicated for that type, are strictly prohibited for use with this device.

Cet appareil numérique de la classe A ou B est conforme à la norme NMB-003 du Canada.

Les changements ou les modifications pas expressément approuvés par la partie responsable de la conformité ont pu vider l'autorité de l'utilisateur pour actionner l'équipement.

### **Concernant les EVMs avec appareils radio**

Le présent appareil est conforme aux CNR d'Industrie Canada applicables aux appareils radio exempts de licence. L'exploitation est autorisée aux deux conditions suivantes : (1) l'appareil ne doit pas produire de brouillage, et (2) l'utilisateur de l'appareil doit accepter tout brouillage radioélectrique subi, même si le brouillage est susceptible d'en compromettre le fonctionnement.

### **Concernant les EVMs avec antennes détachables**

Conformément à la réglementation d'Industrie Canada, le présent émetteur radio peut fonctionner avec une antenne d'un type et d'un gain maximal (ou inférieur) approuvé pour l'émetteur par Industrie Canada. Dans le but de réduire les risques de brouillage radioélectrique à l'intention des autres utilisateurs, il faut choisir le type d'antenne et son gain de sorte que la puissance isotrope rayonnée équivalente (p.i.r.e.) ne dépasse pas l'intensité nécessaire à l'établissement d'une communication satisfaisante.

Le présent émetteur radio a été approuvé par Industrie Canada pour fonctionner avec les types d'antenne énumérés dans le manuel d'usage et ayant un gain admissible maximal et l'impédance requise pour chaque type d'antenne. Les types d'antenne non inclus dans cette liste, ou dont le gain est supérieur au gain maximal indiqué, sont strictement interdits pour l'exploitation de l'émetteur.

## **【Important Notice for Users of this Product in Japan】**

**This development kit is NOT certified as Confirming to Technical Regulations of Radio Law of Japan**

If you use this product in Japan, you are required by Radio Law of Japan to follow the instructions below with respect to this product:

1. Use this product in a shielded room or any other test facility as defined in the notification #173 issued by Ministry of Internal Affairs and Communications on March 28, 2006, based on Sub-section 1.1 of Article 6 of the Ministry's Rule for Enforcement of Radio Law of Japan,
2. Use this product only after you obtained the license of Test Radio Station as provided in Radio Law of Japan with respect to this product, or
3. Use of this product only after you obtained the Technical Regulations Conformity Certification as provided in Radio Law of Japan with respect to this product. Also, please do not transfer this product, unless you give the same notice above to the transferee. Please note that if you could not follow the instructions above, you will be subject to penalties of Radio Law of Japan.

**Texas Instruments Japan Limited**  
**(address) 24-1, Nishi-Shinjuku 6 chome, Shinjuku-ku, Tokyo, Japan**

<http://www.tij.co.jp>

### **【ご使用にあたっての注】**

本開発キットは技術基準適合証明を受けておりません。

本製品のご使用に際しては、電波法遵守のため、以下のいずれかの措置を取っていただく必要がありますのでご注意ください。

1. 電波法施行規則第6条第1項第1号に基づく平成18年3月28日総務省告示第173号で定められた電波暗室等の試験設備でご使用いただく。
2. 実験局の免許を取得後ご使用いただく。
3. 技術基準適合証明を取得後ご使用いただく。

なお、本製品は、上記の「ご使用にあたっての注意」を譲渡先、移転先に通知しない限り、譲渡、移転できないものとします。

上記を遵守頂けない場合は、電波法の罰則が適用される可能性があることをご留意ください。

日本テキサス・インスツルメンツ株式会社  
東京都新宿区西新宿6丁目24番1号  
西新宿三井ビル

<http://www.tij.co.jp>

## EVALUATION BOARD/KIT/MODULE (EVM) WARNINGS, RESTRICTIONS AND DISCLAIMERS

**For Feasibility Evaluation Only, in Laboratory/Development Environments.** Unless otherwise indicated, this EVM is not a finished electrical equipment and not intended for consumer use. It is intended solely for use for preliminary feasibility evaluation in laboratory/development environments by technically qualified electronics experts who are familiar with the dangers and application risks associated with handling electrical mechanical components, systems and subsystems. It should not be used as all or part of a finished end product.

Your Sole Responsibility and Risk. You acknowledge, represent and agree that:

1. You have unique knowledge concerning Federal, State and local regulatory requirements (including but not limited to Food and Drug Administration regulations, if applicable) which relate to your products and which relate to your use (and/or that of your employees, affiliates, contractors or designees) of the EVM for evaluation, testing and other purposes.
2. You have full and exclusive responsibility to assure the safety and compliance of your products with all such laws and other applicable regulatory requirements, and also to assure the safety of any activities to be conducted by you and/or your employees, affiliates, contractors or designees, using the EVM. Further, you are responsible to assure that any interfaces (electronic and/or mechanical) between the EVM and any human body are designed with suitable isolation and means to safely limit accessible leakage currents to minimize the risk of electrical shock hazard.
3. You will employ reasonable safeguards to ensure that your use of the EVM will not result in any property damage, injury or death, even if the EVM should fail to perform as described or expected.
4. You will take care of proper disposal and recycling of the EVM's electronic components and packing materials.

**Certain Instructions.** It is important to operate this EVM within TI's recommended specifications and environmental considerations per the user guidelines. Exceeding the specified EVM ratings (including but not limited to input and output voltage, current, power, and environmental ranges) may cause property damage, personal injury or death. If there are questions concerning these ratings please contact a TI field representative prior to connecting interface electronics including input power and intended loads. Any loads applied outside of the specified output range may result in unintended and/or inaccurate operation and/or possible permanent damage to the EVM and/or interface electronics. Please consult the EVM User's Guide prior to connecting any load to the EVM output. If there is uncertainty as to the load specification, please contact a TI field representative. During normal operation, some circuit components may have case temperatures greater than 60°C as long as the input and output are maintained at a normal ambient operating temperature. These components include but are not limited to linear regulators, switching transistors, pass transistors, and current sense resistors which can be identified using the EVM schematic located in the EVM User's Guide. When placing measurement probes near these devices during normal operation, please be aware that these devices may be very warm to the touch. As with all electronic evaluation tools, only qualified personnel knowledgeable in electronic measurement and diagnostics normally found in development environments should use these EVMs.

**Agreement to Defend, Indemnify and Hold Harmless.** You agree to defend, indemnify and hold TI, its licensors and their representatives harmless from and against any and all claims, damages, losses, expenses, costs and liabilities (collectively, "Claims") arising out of or in connection with any use of the EVM that is not in accordance with the terms of the agreement. This obligation shall apply whether Claims arise under law of tort or contract or any other legal theory, and even if the EVM fails to perform as described or expected.

**Safety-Critical or Life-Critical Applications.** If you intend to evaluate the components for possible use in safety critical applications (such as life support) where a failure of the TI product would reasonably be expected to cause severe personal injury or death, such as devices which are classified as FDA Class III or similar classification, then you must specifically notify TI of such intent and enter into a separate Assurance and Indemnity Agreement.

Mailing Address: Texas Instruments, Post Office Box 655303, Dallas, Texas 75265  
Copyright © 2012, Texas Instruments Incorporated

## IMPORTANT NOTICE

Texas Instruments Incorporated and its subsidiaries (TI) reserve the right to make corrections, enhancements, improvements and other changes to its semiconductor products and services per JESD46, latest issue, and to discontinue any product or service per JESD48, latest issue. Buyers should obtain the latest relevant information before placing orders and should verify that such information is current and complete. All semiconductor products (also referred to herein as "components") are sold subject to TI's terms and conditions of sale supplied at the time of order acknowledgment.

TI warrants performance of its components to the specifications applicable at the time of sale, in accordance with the warranty in TI's terms and conditions of sale of semiconductor products. Testing and other quality control techniques are used to the extent TI deems necessary to support this warranty. Except where mandated by applicable law, testing of all parameters of each component is not necessarily performed.

TI assumes no liability for applications assistance or the design of Buyers' products. Buyers are responsible for their products and applications using TI components. To minimize the risks associated with Buyers' products and applications, Buyers should provide adequate design and operating safeguards.

TI does not warrant or represent that any license, either express or implied, is granted under any patent right, copyright, mask work right, or other intellectual property right relating to any combination, machine, or process in which TI components or services are used. Information published by TI regarding third-party products or services does not constitute a license to use such products or services or a warranty or endorsement thereof. Use of such information may require a license from a third party under the patents or other intellectual property of the third party, or a license from TI under the patents or other intellectual property of TI.

Reproduction of significant portions of TI information in TI data books or data sheets is permissible only if reproduction is without alteration and is accompanied by all associated warranties, conditions, limitations, and notices. TI is not responsible or liable for such altered documentation. Information of third parties may be subject to additional restrictions.

Resale of TI components or services with statements different from or beyond the parameters stated by TI for that component or service voids all express and any implied warranties for the associated TI component or service and is an unfair and deceptive business practice. TI is not responsible or liable for any such statements.

Buyer acknowledges and agrees that it is solely responsible for compliance with all legal, regulatory and safety-related requirements concerning its products, and any use of TI components in its applications, notwithstanding any applications-related information or support that may be provided by TI. Buyer represents and agrees that it has all the necessary expertise to create and implement safeguards which anticipate dangerous consequences of failures, monitor failures and their consequences, lessen the likelihood of failures that might cause harm and take appropriate remedial actions. Buyer will fully indemnify TI and its representatives against any damages arising out of the use of any TI components in safety-critical applications.

In some cases, TI components may be promoted specifically to facilitate safety-related applications. With such components, TI's goal is to help enable customers to design and create their own end-product solutions that meet applicable functional safety standards and requirements. Nonetheless, such components are subject to these terms.

No TI components are authorized for use in FDA Class III (or similar life-critical medical equipment) unless authorized officers of the parties have executed a special agreement specifically governing such use.

Only those TI components which TI has specifically designated as military grade or "enhanced plastic" are designed and intended for use in military/aerospace applications or environments. Buyer acknowledges and agrees that any military or aerospace use of TI components which have **not** been so designated is solely at the Buyer's risk, and that Buyer is solely responsible for compliance with all legal and regulatory requirements in connection with such use.

TI has specifically designated certain components which meet ISO/TS16949 requirements, mainly for automotive use. Components which have not been so designated are neither designed nor intended for automotive use; and TI will not be responsible for any failure of such components to meet such requirements.

### Products

Audio	<a href="http://www.ti.com/audio">www.ti.com/audio</a>
Amplifiers	<a href="http://amplifier.ti.com">amplifier.ti.com</a>
Data Converters	<a href="http://dataconverter.ti.com">dataconverter.ti.com</a>
DLP® Products	<a href="http://www.dlp.com">www.dlp.com</a>
DSP	<a href="http://dsp.ti.com">dsp.ti.com</a>
Clocks and Timers	<a href="http://www.ti.com/clocks">www.ti.com/clocks</a>
Interface	<a href="http://interface.ti.com">interface.ti.com</a>
Logic	<a href="http://logic.ti.com">logic.ti.com</a>
Power Mgmt	<a href="http://power.ti.com">power.ti.com</a>
Microcontrollers	<a href="http://microcontroller.ti.com">microcontroller.ti.com</a>
RFID	<a href="http://www.ti-rfid.com">www.ti-rfid.com</a>
OMAP Applications Processors	<a href="http://www.ti.com/omap">www.ti.com/omap</a>
Wireless Connectivity	<a href="http://www.ti.com/wirelessconnectivity">www.ti.com/wirelessconnectivity</a>

### Applications

Automotive and Transportation	<a href="http://www.ti.com/automotive">www.ti.com/automotive</a>
Communications and Telecom	<a href="http://www.ti.com/communications">www.ti.com/communications</a>
Computers and Peripherals	<a href="http://www.ti.com/computers">www.ti.com/computers</a>
Consumer Electronics	<a href="http://www.ti.com/consumer-apps">www.ti.com/consumer-apps</a>
Energy and Lighting	<a href="http://www.ti.com/energy">www.ti.com/energy</a>
Industrial	<a href="http://www.ti.com/industrial">www.ti.com/industrial</a>
Medical	<a href="http://www.ti.com/medical">www.ti.com/medical</a>
Security	<a href="http://www.ti.com/security">www.ti.com/security</a>
Space, Avionics and Defense	<a href="http://www.ti.com/space-avionics-defense">www.ti.com/space-avionics-defense</a>
Video and Imaging	<a href="http://www.ti.com/video">www.ti.com/video</a>

### TI E2E Community

[e2e.ti.com](http://e2e.ti.com)