

Data sheet | Item number: 750-455/020-000

4-channel analog input; 4 ... 20 mA; Single-ended; 4 x 24 V

www.wago.com/750-455/020-000

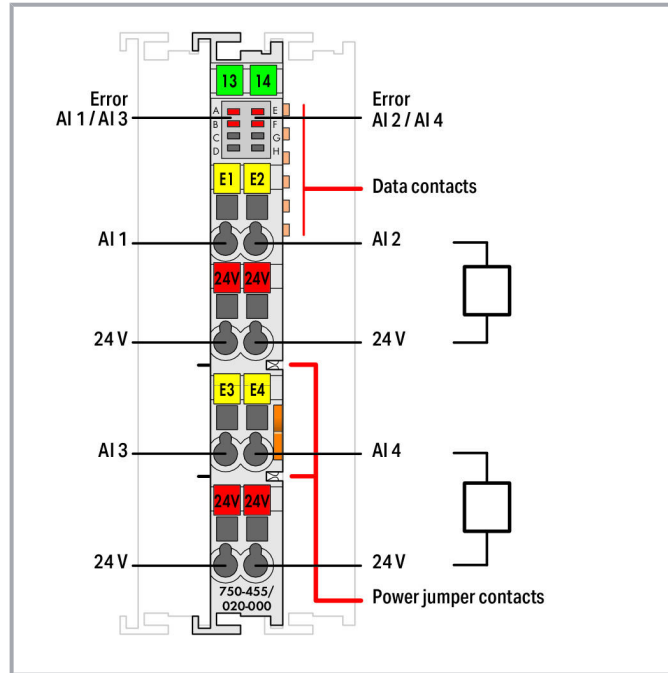

Subject to changes. Please also observe the further product documentation!

WAGO GmbH & Co. KG
Hansastr. 27
32423 Minden
Phone: +49571 887-0 | Fax: +49571 887-169
Email: info.de@wago.com | Web: www.wago.com

Do you have any questions about our products?
We are always happy to take your call at +49 (571) 887-44222.

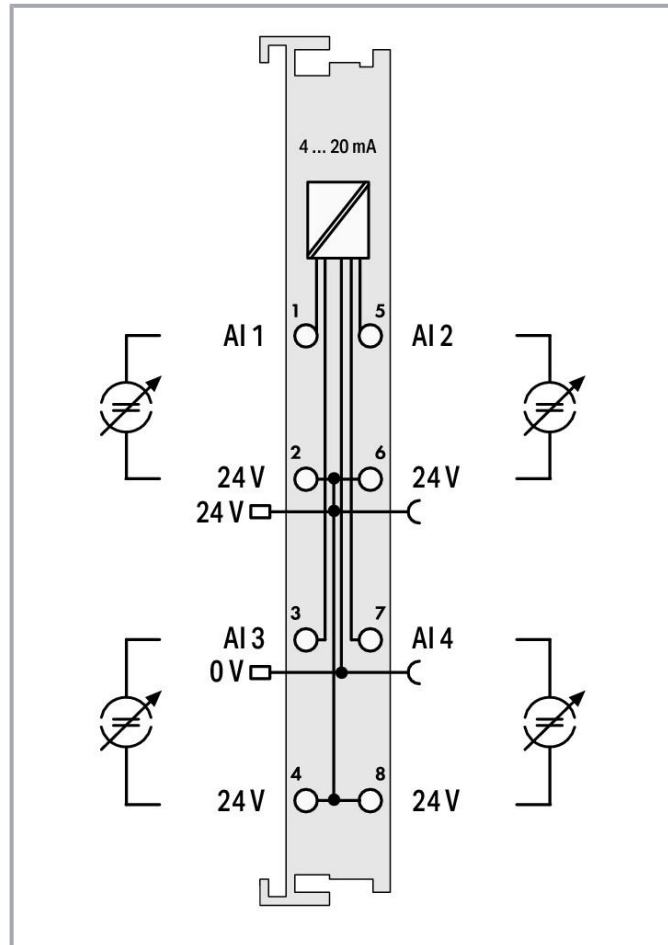
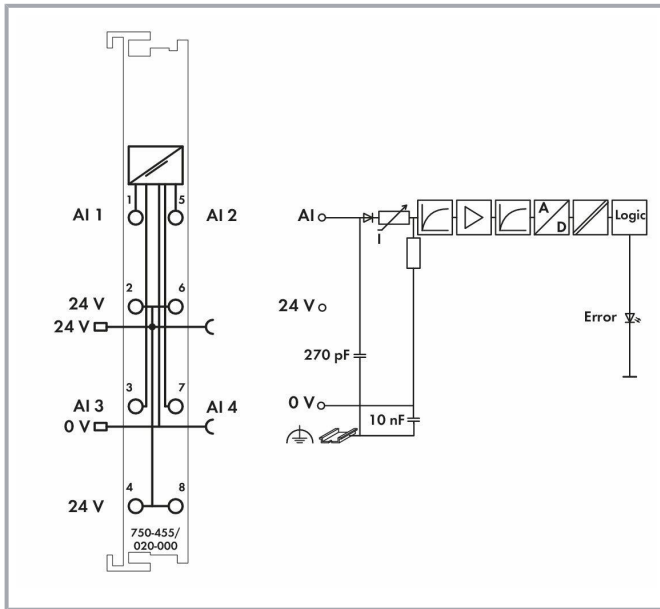

Item description

This analog input module processes standard 4–20 V signals.

The input signal is electrically isolated and transmitted with a resolution of 12 bits.

The internal system supply powers the module.

The input channels of the module have a common ground potential.

The module provides a 24 V power supply for a direct connection to 2-wire sensors.

Data

Technical data

Number of analog inputs	4
Total number of channels (module)	4

Subject to changes. Please also observe the further product documentation!

WAGO GmbH & Co. KG

Hansastr. 27

32423 Minden

Phone: +49571 887-0 | Fax: +49571 887-169

Email: info.de@wago.com | Web: www.wago.com

Do you have any questions about our products?

We are always happy to take your call at +49 (571) 887-44222.



Signal type	Current
Signal type (current)	4 ... 20 mADC
Sensor connection	4 x (2-wire)
Input voltage (max.)	32 V
Signal characteristic	Single-ended
Resolution [bit]	12 bits
Input resistance (max.)	100 Ω
Data width	4 x 16-bit data; 4 x 8-bit control/status (optional)
Conversion time (typ.)	10 ms
Measurement error (reference temperature)	25 °C
Measurement error – deviation (max.) from the upper-range value	0.1 %
Temperature error (max.) of the upper-range value	0.01 %/K
Supply voltage (system)	5 VDC; via data contacts
Power consumption (5 V system supply)	65 mA
Supply voltage (field)	24 VDC (-25 ... +30 %); via power jumper contacts (power supply via blade contact; transmission via spring contact)
Isolation	500 V system/field
Number of incoming power jumper contacts	2
Number of outgoing power jumper contacts	2

Connection data

Connection technology: inputs/outputs	8 x CAGE CLAMP®
Connection type (1)	Inputs/Outputs
Solid conductor	0.08 ... 2.5 mm ² / 28 ... 14 AWG
Fine-stranded conductor	0.08 ... 2.5 mm ² / 28 ... 14 AWG
Strip length	8 ... 9 mm / 0.31 ... 0.35 inch

Physical data

Width	12 mm / 0.472 inch
Height	100 mm / 3.937 inch
Depth	67.8 mm / 2.669 inch
Depth from upper edge of DIN-rail	60.6 mm / 2.386 inch

Mechanical data

Mounting type	DIN-35 rail
---------------	-------------

Subject to changes. Please also observe the further product documentation!



Material data

Color	-
Housing material	Polycarbonate; polyamide 6.6
Fire load	0.954 MJ
Weight	50 g
Conformity marking	CE

Environmental requirements

Surrounding air temperature (operation)	0 ... 55 °C
Surrounding air temperature (storage)	-40 ... 85 °C
Protection type	IP20
Pollution degree (5)	2 per IEC 61131-2
Operating altitude	0 ... 2000 m
Mounting position	horizontal (standing/lying); vertical
Relative humidity (without condensation)	95 %
Vibration resistance	per IEC 60068-2-6
Shock resistance	15g per IEC 60068-2-27
EMC immunity to interference	per EN 61000-6-2, marine applications
EMC emission of interference	per EN 61000-6-4, marine applications
Exposure to pollutants	Per IEC 60068-2-42 and IEC 60068-2-43
Permissible H ₂ S contaminant concentration at a relative humidity 75 %	10 ppm
Permissible SO ₂ contaminant concentration at a relative humidity 75 %	25 ppm

Commercial data

PU (SPU)	1 Stück
Packaging type	box
Country of origin	DE
GTIN	4055143234665
Customs tariff number	85389099990

Approvals / Certificates

Ex-Approvals





Logo	Approval	Additional Approval Text	Certificate name
------	----------	--------------------------	------------------

Subject to changes. Please also observe the further product documentation!

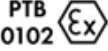

WAGO GmbH & Co. KG
 Hansastr. 27
 32423 Minden
 Phone: +49571 887-0 | Fax: +49571 887-169
 Email: info.de@wago.com | Web: www.wago.com

Do you have any questions about our products?
 We are always happy to take your call at +49 (571) 887-44222.





	ATEX TUEV Nord Cert GmbH	EN 60079-0	TUEV_14_ATEX_148929_X (II 3 G Ex ex IIC T4 Gc)
	CCCEX CQST/CNEx	CNCA-C23-01	2020312310000213 (Ex nA IIC T4 Gc)
	EAC Brjansker Zertifizierungsstelle	TP TC 012/2011	EAC RU C-DE.AM02.B. 00163/19 (2Ex e IIC T4 Gc X)
	IECEX TUEV Nord Cert GmbH	IEC 60079-0	IECEX_TUN_14.0035_X (Ex ec IIC T4 Gc)
	UL Underwriters Laboratories Inc. (HAZARDOUS LOCATIONS)	UL 121201	E198726 Sec.1

Country specific Approvals

Logo	Approval	Additional Approval Text	Certificate name
	EAC Brjansker Zertifizierungsstelle	TP TC 020/2011	EAC RU C- DE.AM02. B.00087 /19
	KC National Radio Research Agency	Article 58-2, Clause 3	MSIP- REM-W43- AIM750

Ship Approvals



Logo	Approval	Additional Approval Text	Certificate name
	ABS American Bureau of Shipping	-	19- HG1821926
	BV Bureau Veritas S.A.	Rules for class. of Steel Ships	66711/A0
	DNV GL	-	TAA0000194

Subject to changes. Please also observe the further product documentation!

WAGO GmbH & Co. KG
Hansastr. 27
32423 Minden
Phone: +49571 887-0 | Fax: +49571 887-169
Email: info.de@wago.com | Web: www.wago.com

Do you have any questions about our products?
We are always happy to take your call at +49 (571) 887-44222.

Det Norske Veritas, Germanischer Lloyd

	KR Korean Register of Shipping	-	KR HMB05880- AC001
	LR Lloyds Register EMEA	-	02/20026 (E6)
	PRS Polski Rejestr Statków	-	TE/2236 /880590/19





UL-Approvals

Logo	Approval	Additional Approval Text	Certificate name
	UL UL International Netherlands B.V. (ORDINARY LOCATIONS)	UL 508	E175199 Sec.1

Optional accessories

Carrier rail

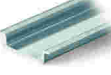
Mounting accessories

	Item no.: 210-197 Steel carrier rail; 35 x 15 mm; 1.5 mm thick; 2 m long; slotted; similar to EN 60715; silver-colored	www.wago.com/210-197
	Item no.: 210-198 Copper carrier rail; 35 x 15 mm; 2.3 mm thick; 2 m long; unslotted; according to EN 60715; copper-colored	www.wago.com/210-198
	Item no.: 210-504 Steel carrier rail; 35 x 7.5 mm; 1 mm thick; 2 m long; slotted; galvanized; according to EN 60715; silver-colored	www.wago.com/210-504
	Item no.: 210-505 Steel carrier rail; 35 x 7.5 mm; 1 mm thick; 2 m long; unslotted; galvanized; according to EN 60715; silver-colored	www.wago.com/210-505
	Item no.: 210-506 Steel carrier rail; 35 x 15 mm; 1.5 mm thick; 2 m long; unslotted; galvanized; similar to EN 60715; silver-colored	www.wago.com/210-506
	Item no.: 210-508 Steel carrier rail; 35 x 15 mm; 1.5 mm thick; 2 m long; slotted; galvanized; similar to EN 60715; silver-colored	www.wago.com/210-508

Subject to changes. Please also observe the further product documentation!

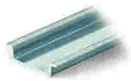

Item no.: 210-113

Steel carrier rail; 35 x 7.5 mm; 1 mm thick; 2 m long; unslotted; according to EN 60715; silver-colored

www.wago.com/210-113



Item no.: 210-118

Steel carrier rail; 35 x 15 mm; 2.3 mm thick; 2 m long; unslotted; according to EN 60715; silver-colored

www.wago.com/210-118



Item no.: 210-112

Steel carrier rail; 35 x 7.5 mm; 1 mm thick; 2 m long; slotted; according to EN 60715; "Hole width 25 mm; silver-colored

www.wago.com/210-112



Item no.: 210-114

Steel carrier rail; 35 x 15 mm; 1.5 mm thick; 2 m long; unslotted; similar to EN 60715; silver-colored

www.wago.com/210-114



Item no.: 210-115

Steel carrier rail; 35 x 7.5 mm; 1 mm thick; 2 m long; slotted; according to EN 60715; "Hole width 18 mm; silver-colored

www.wago.com/210-115

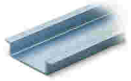

Item no.: 210-196

Aluminum carrier rail; 35 x 8.2 mm; 1.6 mm thick; 2 m long; unslotted; similar to EN 60715; silver-colored

www.wago.com/210-196

Supply module

Supply module



Item no.: 750-601

Power Supply; 24 VDC; fuse holder

www.wago.com/750-601



Item no.: 750-610

Power Supply; 24 VDC; fuse holder; Diagnostics

www.wago.com/750-610



Item no.: 750-602

Power Supply; 24 VDC

www.wago.com/750-602



Item no.: 750-612

Power Supply; 0 ... 230 V AC/DC

www.wago.com/750-612

System housing

System enclosure

Item no.: 850-814/002-000

IP65 enclosure; Sheet steel (RAL 7035); WxHxD (200x120x200 mm); without flange plate

www.wago.com/850-814/002-000

Item no.: 850-815/002-000

IP65 enclosure; Sheet steel (RAL 7035); WxHxD (300x120x200 mm); without flange plate

www.wago.com/850-815/002-000

Item no.: 850-816/002-000

IP65 enclosure; Sheet steel (RAL 7035); WxHxD (400x120x200 mm); without flange plate

www.wago.com/850-816/002-000

Item no.: 850-817/002-000

IP65 enclosure; Sheet steel (RAL 7035); WxHxD (600x120x200 mm); without flange plate

www.wago.com/850-817/002-000

Subject to changes. Please also observe the further product documentation!

WAGO GmbH & Co. KG

Hansastr. 27

32423 Minden

Phone: +49571 887-0 | Fax: +49571 887-169

Email: info.de@wago.com | Web: www.wago.com

Do you have any questions about our products?

We are always happy to take your call at +49 (571) 887-44222.



Item no.: 850-825

IP65 enclosure; Aluminium (RAL 7032); WxHxD (160x100x160 mm); 9 x M12, 4 x M20

www.wago.com/850-825



Item no.: 850-826

IP65 enclosure; Aluminium (RAL 7032); WxHxD (240x100x160 mm); 4 x M20, 4 x M16, 14 x M12 cable grip

www.wago.com/850-826



Item no.: 850-827

IP65 enclosure; Aluminium (RAL 7032); WxHxD (320x100x160 mm); 4 x M20, 8 x M16, 17 x M12 cable grip

www.wago.com/850-827

Item no.: 850-827/002-000

IP65 enclosure; Aluminium (RAL 7035); WxHxD (320x100x160 mm); 4 x M20, 8 x M16, 17 x M12 cable grip

www.wago.com/850-827/002-000

Item no.: 850-826/002-000

IP65 enclosure; Aluminium (RAL 7035); WxHxD (240x100x160 mm); 4 x M20, 4 x M16, 14 x M12 cable grip

www.wago.com/850-826/002-000

Item no.: 850-828/002-000

IP65 enclosure; Aluminium (RAL 7035); WxHxD (480x100x160 mm); 4 x M20, 10 x M16, 35 x M12 cable grip

www.wago.com/850-828/002-000



Item no.: 850-828

IP65 enclosure; Aluminium (RAL 7032); WxHxD (480x100x160 mm); 4 x M20, 10 x M16, 35 x M12 cable grip

www.wago.com/850-828

Item no.: 850-834

IP65 enclosure; Polyester (RAL 7032); WxHxD (164x100x164 mm); 9 x M12, 4 x M20

www.wago.com/850-834

Item no.: 850-835

IP65 enclosure; Polyester (RAL 7032); WxHxD (244x100x164 mm); 4 x M20, 4 x M16, 14 x M12 cable grip

www.wago.com/850-835

Item no.: 850-836

IP65 enclosure; Polyester (RAL 7032); WxHxD (324x100x164 mm); 4 x M20, 8 x M16, 17 x M12 cable grip

www.wago.com/850-836

Marking accessories

Marker carrier

Item no.: 750-103

Group marker carrier

www.wago.com/750-103

Marker

Item no.: 2009-145/000-006

Mini-WSB Inline; for Smart Printer; 1700 pieces on roll; stretchable 5 - 5.2 mm; plain; snap-on type; blue

www.wago.com/2009-145/000-006

Item no.: 2009-145

Mini-WSB Inline; for Smart Printer; 1700 pieces on roll; stretchable 5 - 5.2 mm; plain; snap-on type; white

www.wago.com/2009-145

Item no.: 2009-145/000-002

Mini-WSB Inline; for Smart Printer; 1700 pieces on roll; stretchable 5 - 5.2 mm; plain; snap-on type; yellow

www.wago.com/2009-145/000-002

Subject to changes. Please also observe the further product documentation!

WAGO GmbH & Co. KG

Hansastr. 27

32423 Minden

Phone: +49571 887-0 | Fax: +49571 887-169

Email: info.de@wago.com | Web: www.wago.com

Do you have any questions about our products?

We are always happy to take your call at +49 (571) 887-44222.

Item no.: 2009-145/000-007 www.wago.com/2009-145/000-007
Mini-WSB Inline; for Smart Printer; 1700 pieces on roll; stretchable 5 - 5.2 mm; plain; snap-on type; gray

Item no.: 2009-145/000-005 www.wago.com/2009-145/000-005
Mini-WSB Inline; for Smart Printer; 1700 pieces on roll; stretchable 5 - 5.2 mm; plain; snap-on type; red

Item no.: 2009-145/000-012 www.wago.com/2009-145/000-012
Mini-WSB Inline; for Smart Printer; 1700 pieces on roll; stretchable 5 - 5.2 mm; plain; snap-on type; orange

Item no.: 2009-145/000-023 www.wago.com/2009-145/000-023
Mini-WSB Inline; for Smart Printer; 1700 pieces on roll; stretchable 5 - 5.2 mm; plain; snap-on type; green

Item no.: 2009-145/000-024 www.wago.com/2009-145/000-024
Mini-WSB Inline; for Smart Printer; 1700 pieces on roll; stretchable 5 - 5.2 mm; plain; snap-on type; violet



Item no.: 248-501/000-006 www.wago.com/248-501/000-006
Mini-WSB marking card; as card; not stretchable; plain; snap-on type; blue



Item no.: 248-501/000-007 www.wago.com/248-501/000-007
Mini-WSB marking card; as card; not stretchable; plain; snap-on type; gray



Item no.: 248-501/000-002 www.wago.com/248-501/000-002
Mini-WSB marking card; as card; not stretchable; plain; snap-on type; yellow



Item no.: 248-501/000-012 www.wago.com/248-501/000-012
Mini-WSB marking card; as card; not stretchable; plain; snap-on type; orange



Item no.: 248-501 www.wago.com/248-501
Mini-WSB marking card; as card; not stretchable; plain; snap-on type; white



Item no.: 248-501/000-017 www.wago.com/248-501/000-017
Mini-WSB marking card; as card; not stretchable; plain; snap-on type; light green



Item no.: 248-501/000-005 www.wago.com/248-501/000-005
Mini-WSB marking card; as card; not stretchable; plain; snap-on type; red

Subject to changes. Please also observe the further product documentation!



Item no.: 248-501/000-024

Mini-WSB marking card; as card; not stretchable; plain; snap-on type; violet

www.wago.com/248-501/000-024



Item no.: 248-501/000-023

Mini-WSB marking card; as card; not stretchable; plain; snap-on type; green

www.wago.com/248-501/000-023

Group marker carrier

Item no.: 750-107

Group marker carrier

www.wago.com/750-107

Shield termination

Shield clamping saddle



Item no.: 790-116

Shield clamping saddle; 19 mm wide; diameter of compatible conductor; 7 ... 16 mm

www.wago.com/790-116



Item no.: 790-124

Shield clamping saddle; 27 mm wide; diameter of compatible conductor; 6 ... 24 mm

www.wago.com/790-124



Item no.: 790-108

Shield clamping saddle; 11 mm wide; diameter of compatible conductor; 3 ... 8 mm

www.wago.com/790-108



Item no.: 790-140

Shield clamping saddle; diameter of compatible conductor

www.wago.com/790-140

Item no.: 790-216

Shield clamping saddle; 21.8 mm wide; 6 ... 16 mm

www.wago.com/790-216

Item no.: 790-220

Shield clamping saddle; 30 mm wide; 6 ... 20 mm

www.wago.com/790-220

Item no.: 790-208

Shield clamping saddle; 12.4 mm wide; 3 ... 8 mm

www.wago.com/790-208

Downloads

Documentation

Manual

System Manual WAGO I/O System 750 / 753 Decentralized Automation Technology	V 3.0.3 17-Nov-2021	pdf 6.6 MB	Download
--	------------------------	---------------	----------

4-channel, 4-20mA, single-ended 4 x 24 V		pdf 2.0 MB	Download
---	--	---------------	----------

System Manual Series 750/753 Online HTML		URL	Download
---	--	-----	----------

Subject to changes. Please also observe the further product documentation!

WAGO GmbH & Co. KG
Hansastr. 27
32423 Minden
Phone: +49571 887-0 | Fax: +49571 887-169
Email: info.de@wago.com | Web: www.wago.com

Do you have any questions about our products?
We are always happy to take your call at +49 (571) 887-44222.

**Bid Text**

750-455/020-000 X81 - Datei	19-Feb-2019	xml 4.4 kB	Download
--------------------------------	-------------	---------------	----------

750-455/020-000 doc - Datei	17-Oct-2017	doc 28.7 kB	Download
--------------------------------	-------------	----------------	----------

ausschreiben.de 750-455/020-000		URL	Download
---------------------------------	--	-----	----------

Additional Information

Disposal; Electrical and electronic equipment, Packaging	V 1.0.0	pdf 265.8 kB	Download
--	---------	-----------------	----------

System Description

Use in Hazardous Environments Term definition, marking and installation regulations	V 1.0.0	pdf 1.0 MB	Download
--	---------	---------------	----------

750/753 Series I/O-System – General Product Information		pdf 1.7 MB	Download
---	--	---------------	----------

Overview on WAGO-I/O-SYSTEM 750 approvals		pdf 780.2 kB	Download
---	--	-----------------	----------

CAD/CAE-Data**CAD data**

2D/3D Models 750-455/020-000		URL	Download
------------------------------	--	-----	----------

CAE data

EPLAN Data Portal 750-455/020-000		URL	Download
-----------------------------------	--	-----	----------

WSCAD Universe 750-455/020-000		URL	Download
--------------------------------	--	-----	----------

ZUKEN Portal 750-455/020-000		URL	Download
------------------------------	--	-----	----------

WSCAD Universe 750-455/020-000		URL	Download
--------------------------------	--	-----	----------

EPLAN Data Portal 750-455/020-000		URL	Download
-----------------------------------	--	-----	----------

Subject to changes. Please also observe the further product documentation!

WAGO GmbH & Co. KG
 Hansastr. 27
 32423 Minden
 Phone: +49571 887-0 | Fax: +49571 887-169
 Email: info.de@wago.com | Web: www.wago.com

Do you have any questions about our products?
 We are always happy to take your call at +49 (571) 887-44222.



Environmental Product Compliance

Compliance Search

Environmental Product Compliance 750-455/020-000 4-channel analog input; 4 ... 20 mA; Single-ended; 4 x 24 V	URL	Download
---	-----	----------

Installation Notes

Product family

WAGO I/O System 750/753
[Show all products from the family](#)

Subject to changes. Please also observe the further product documentation!

WAGO GmbH & Co. KG
Hansastr. 27
32423 Minden
Phone: +49571 887-0 | Fax: +49571 887-169
Email: info.de@wago.com | Web: www.wago.com

Do you have any questions about our products?
We are always happy to take your call at +49 (571) 887-44222.