

Programmable Controller

CP2E

Micro PLC designed to support data collection and Machine to Machine communication

- Network Model features Ethernet connectivity
+ 4-axis positioning: CP2E-N type
- Standard Model features axis control: CP2E-S type
- Essential Model features basic control: CP2E-E type



CP2E-E20DR-A

CP2E-N30D□□

Features

- Two built-in Ethernet ports with Ethernet switching function:
Ready for Machine to Machine communication (CP2E-N type)
- Up to three serial ports: Open connectivity to serial devices (CP2E-N type)
- Four-axis positioning function with linear interpolation (CP2E-N type)
- Battery-free operation and backup reduce maintenance
- Function blocks and structured text improve programming efficiency
- Operating temperature range from -20 to 60 °C for reliable use in special applications
- Input/output terminal LED indicators for quick troubleshooting

CP2E

System Configuration

N□□-type CPU Unit

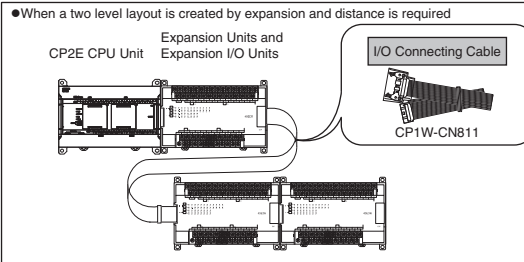
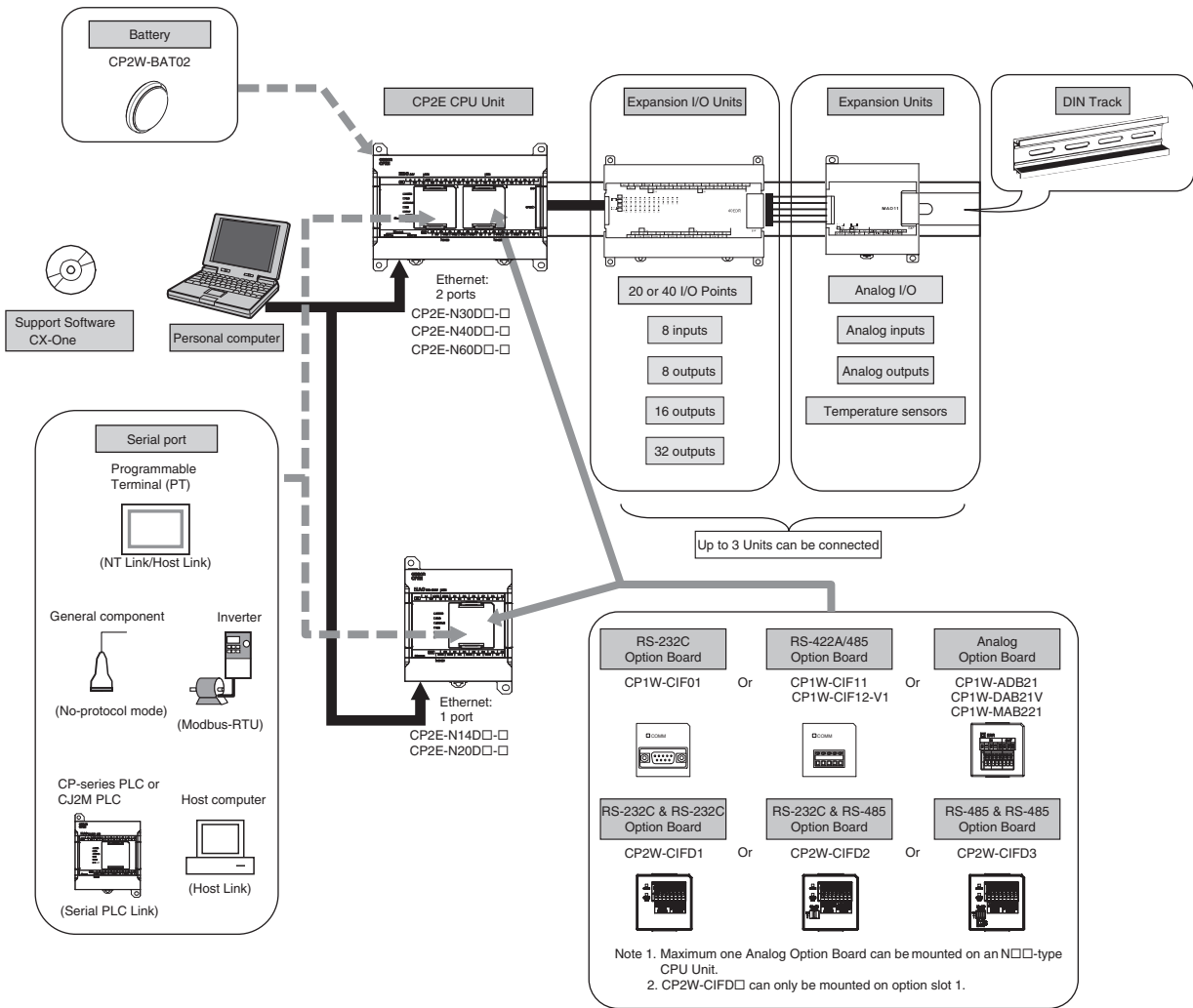

S□□-type CPU Unit

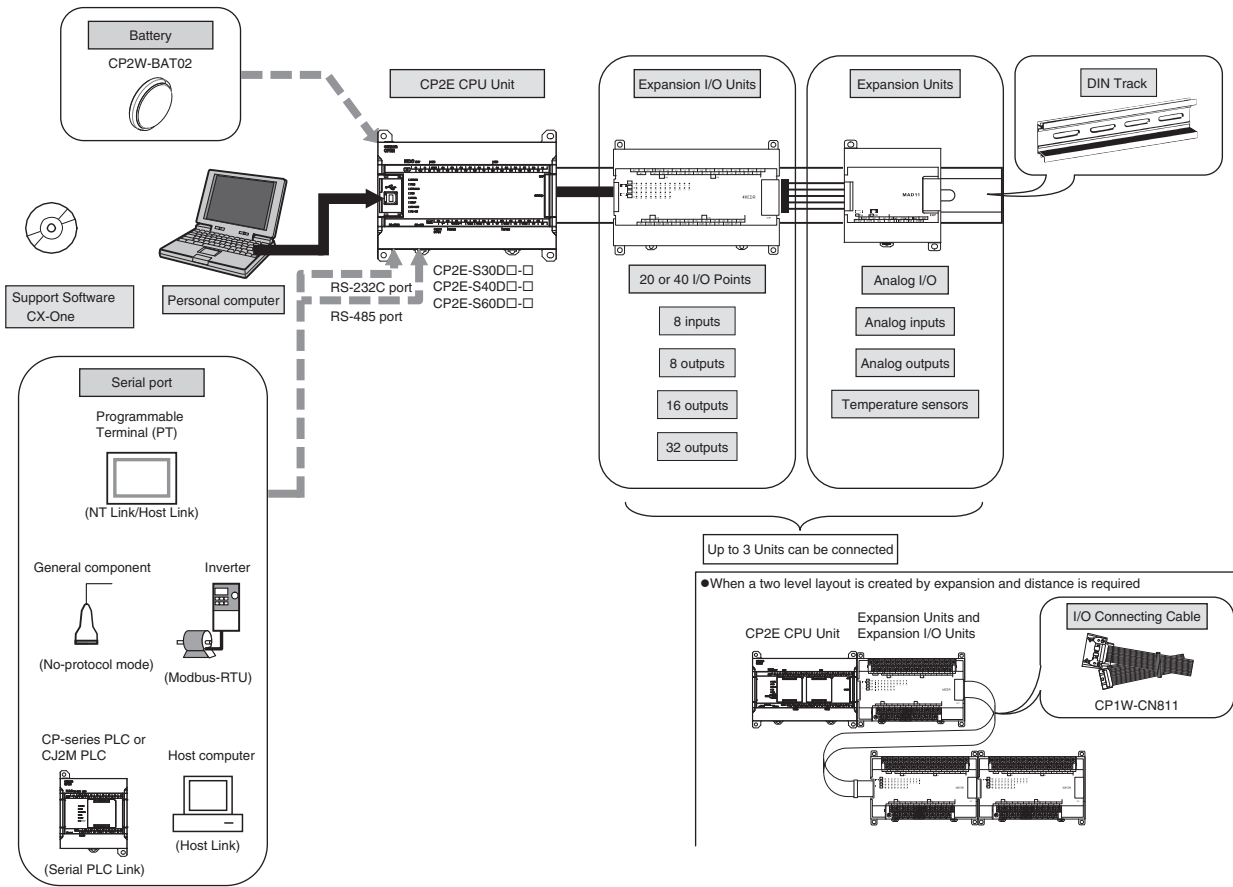

E□□-type CPU Unit

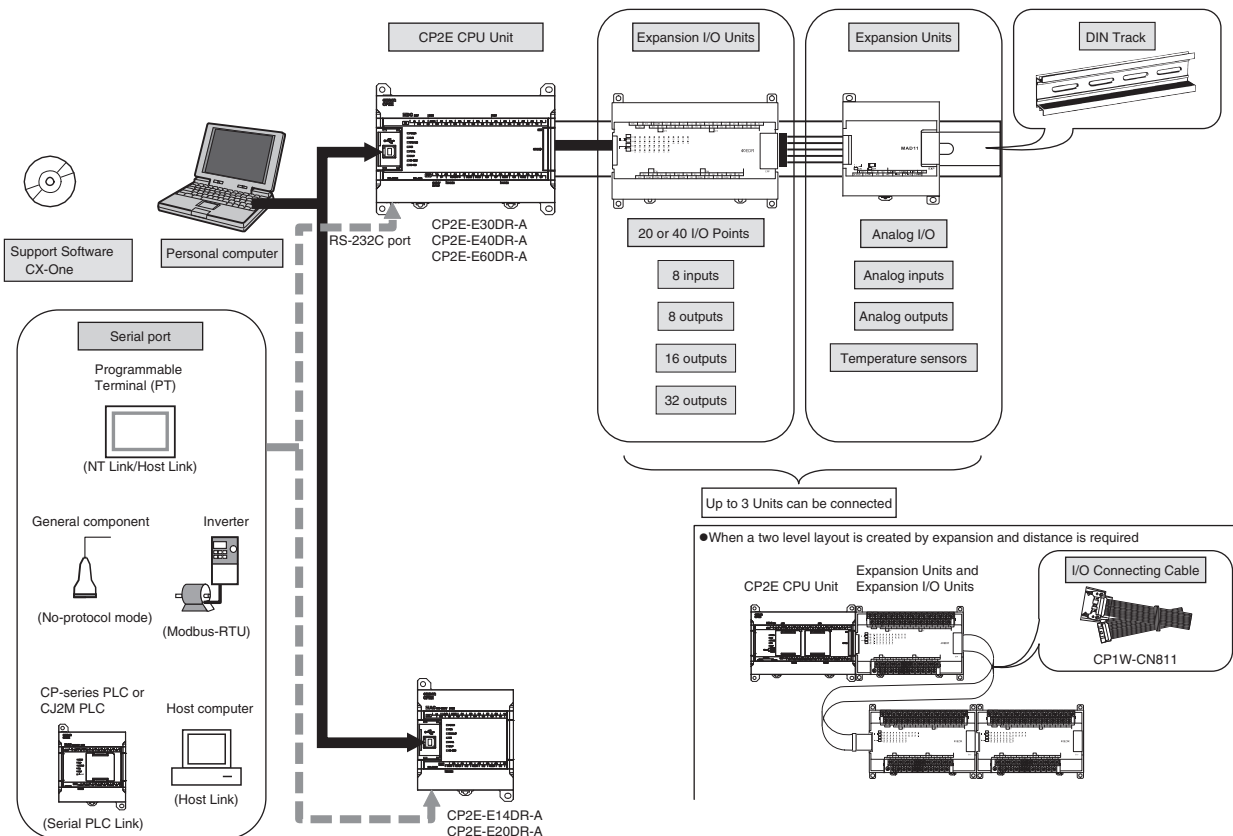

CP2E

Model Number Structure

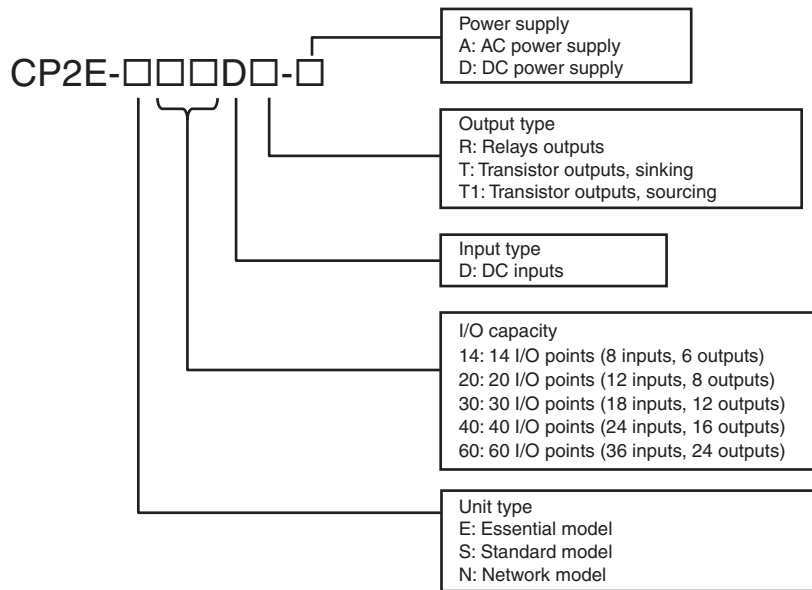





Ordering Information

Applicable standards

Refer to the OMRON website (www.ia.omron.com) or ask your OMRON representative for the most recent applicable standards for each model.



CPU Unit

CP2E-N-type/Network model





| Number of points | Specifications | | | | | | | | Model | | |
|--|----------------|-----------|-----------|-----------------------|------------------------------------|----------------------|------------------------------------|-----------|----------------------|--------|----------------------|
| | Power Supply | Inputs | Outputs | Output type | Program capacity | Data memory capacity | Current consumption | | | | |
| | | | | | | | 5 VDC | 24 VDC | | | |
| CPU Units with 14 points  | 100 to 240 VAC | 8 points | 6 points | Relay | 10K steps (FB capacity: 10K steps) | 16K words | 0.15 A | 0.05 A | CP2E-N14DR-A | | |
| | 24 VDC | | | Transistor (sinking) | | | 0.21 A | 0.02 A | CP2E-N14DT-A | | |
| | | | | Relay | | | 0.15 A | 0.05 A | CP2E-N14DR-D | | |
| | | | | Transistor (sinking) | | | 0.21 A | 0.02 A | CP2E-N14DT-D | | |
| | | | | Transistor (sourcing) | | | 0.22 A | 0.02 A | CP2E-N14DT1-D | | |
| CPU Units with 20 points  | 100 to 240 VAC | 12 points | 8 points | Relay | | | 10K steps (FB capacity: 10K steps) | 16K words | 0.17 A | 0.06 A | CP2E-N20DR-A |
| | 24 VDC | | | Transistor (sinking) | | | | | 0.27 A | 0.02 A | CP2E-N20DT-A |
| | | | | Relay | | | | | 0.17 A | 0.06 A | CP2E-N20DR-D |
| | | | | Transistor (sinking) | | | | | 0.27 A | 0.02 A | CP2E-N20DT-D |
| | | | | Transistor (sourcing) | | | | | 0.26 A | 0.02 A | CP2E-N20DT1-D |
| CPU Units with 30 points  | 100 to 240 VAC | 18 points | 12 points | Relay | 10K steps (FB capacity: 10K steps) | 16K words | | | 0.41 A | 0.07 A | CP2E-N30DR-A |
| | 24 VDC | | | Transistor (sinking) | | | | | 0.52 A | 0.03 A | CP2E-N30DT-A |
| | | | | Relay | | | | | 0.37 A | 0.07 A | CP2E-N30DR-D |
| | | | | Transistor (sinking) | | | | | 0.51 A | 0.03 A | CP2E-N30DT-D |
| | | | | Transistor (sourcing) | | | | | 0.51 A | 0.03 A | CP2E-N30DT1-D |
| CPU Units with 40 points  | 100 to 240 VAC | 24 points | 16 points | Relay | | | 10K steps (FB capacity: 10K steps) | 16K words | 0.39 A | 0.09 A | CP2E-N40DR-A |
| | 24 VDC | | | Transistor (sinking) | | | | | 0.59 A | 0.03 A | CP2E-N40DT-A |
| | | | | Relay | | | | | 0.39 A | 0.09 A | CP2E-N40DR-D |
| | | | | Transistor (sinking) | | | | | 0.59 A | 0.03 A | CP2E-N40DT-D |
| | | | | Transistor (sourcing) | | | | | 0.59 A | 0.03 A | CP2E-N40DT1-D |
| CPU Units with 60 points  | 100 to 240 VAC | 36 points | 24 points | Relay | 10K steps (FB capacity: 10K steps) | 16K words | | | 0.44 A | 0.13 A | CP2E-N60DR-A |
| | 24 VDC | | | Transistor (sinking) | | | | | 0.71 A | 0.03 A | CP2E-N60DT-A |
| | | | | Relay | | | | | 0.41 A | 0.13 A | CP2E-N60DR-D |
| | | | | Transistor (sinking) | | | | | 0.71 A | 0.03 A | CP2E-N60DT-D |
| | | | | Transistor (sourcing) | | | | | 0.71 A | 0.03 A | CP2E-N60DT1-D |

CP2E

CP2E-S-type/Standard model

| Number of points | Specifications | | | | | | | | Model |
|--|----------------|-----------|-----------|-----------------------|--|----------------------|---------------------|--------|----------------------|
| | Power Supply | Inputs | Outputs | Output type | Program capacity | Data memory capacity | Current consumption | | |
| | | | | | | | 5 VDC | 24 VDC | |
| CPU Units with 30 points  | 100 to 240 VAC | 18 points | 12 points | Relay | 8K steps (FB capacity: 8K steps) | 8K words | 0.12 A | 0.07 A | CP2E-S30DR-A |
| | 24 VDC | | | Transistor (sinking) | | | 0.28 A | 0.02 A | CP2E-S30DT-D |
| | | | | Transistor (sourcing) | | | | | CP2E-S30DT1-D |
| CPU Units with 40 points  | 100 to 240 VAC | 24 points | 16 points | Relay | 8K steps (FB capacity: 8K steps) | 8K words | 0.13 A | 0.09 A | CP2E-S40DR-A |
| | 24 VDC | | | Transistor (sinking) | | | 0.34 A | 0.02 A | CP2E-S40DT-D |
| | | | | Transistor (sourcing) | | | | | CP2E-S40DT1-D |
| CPU Units with 60 points  | 100 to 240 VAC | 36 points | 24 points | Relay | 8K steps (FB capacity: 8K steps) | 8K words | 0.16 A | 0.13 A | CP2E-S60DR-A |
| | 24 VDC | | | Transistor (sinking) | | | 0.48 A | 0.02 A | CP2E-S60DT-D |
| | | | | Transistor (sourcing) | | | | | CP2E-S60DT1-D |

CP2E-E-type/Essential model









| Number of points | Specifications | | | | | | | | Model |
|--|----------------|-----------|-----------|-------------|--|----------------------|---------------------|--------|---------------------|
| | Power Supply | Inputs | Outputs | Output type | Program capacity | Data memory capacity | Current consumption | | |
| | | | | | | | 5 VDC | 24 VDC | |
| CPU Units with 14 points  | 100 to 240 VAC | 8 points | 6 points | Relay | 4K steps (FB capacity: 4K steps) | 4K words | 0.06 A | 0.04 A | CP2E-E14DR-A |
| CPU Units with 20 points  | | 12 points | 8 points | Relay | | | 0.08 A | 0.06 A | CP2E-E20DR-A |
| CPU Units with 30 points  | | 18 points | 12 points | Relay | | | 0.12 A | 0.07 A | CP2E-E30DR-A |
| CPU Units with 40 points  | | 24 points | 16 points | Relay | | | 0.13 A | 0.09 A | CP2E-E40DR-A |
| CPU Units with 60 points  | | 36 points | 24 points | Relay | | | 0.16 A | 0.13 A | CP2E-E60DR-A |

Optional Products

Battery

| Product name | Specifications | Model |
|--|--|------------|
| Battery  | Mounted in an N/S□□-type CPU Unit. Mount the Battery when using the clock function. A Battery cannot be mounted to an E□□-type CPU Unit. | CP2W-BAT02 |









Option Board

| Product name | Specifications | Current consumption | | Model |
|--|--|---------------------|--------|---------------|
| | | 5 VDC | 24 VDC | |
| RS-232C Option Board  | Mounted in the option slot of an N□□-type CPU Unit and can be used as an RS-232C port. Maximum transmission distance: 15 m | 0.04 A | --- | CP1W-CIF01 |
| Non-isolated RS-422A/485 Option Board  | Mounted in the option slot of an N□□-type CPU Unit and can be used as an RS-422A/485 port. Maximum transmission distance: 50 m | 0.04 A | --- | CP1W-CIF11 |
| Isolated RS-422A/485 Option Board  | Mounted in the option slot of an N□□-type CPU Unit and can be used as an RS-422A/485 port. Maximum transmission distance: 500 m | 0.04 A | --- | CP1W-CIF12-V1 |
| RS-232C&RS-232C Option Board  | Mounted in the option slot of an N□□-type CPU Unit and can be used as two RS-232C ports. Maximum transmission distance: 15 m | 0.04 A | --- | CP2W-CIFD1 |
| RS-232C&RS-485 Option Board  | Mounted in the option slot of an N□□-type CPU Unit and can be used as one RS-232C port and one isolated RS-485 port. Maximum transmission distance: 15 m (RS-232C) 500 m (RS-485) | 0.06 A | --- | CP2W-CIFD2 |
| RS-485&RS-485 Option Board  | Mounted in the option slot of an N□□-type CPU Unit and can be used as two isolated RS-485 ports. Maximum transmission distance: 500 m | 0.08 A | --- | CP2W-CIFD3 |
| Analog Input Option Board  | Mounted in the option slot of an N□□-type CPU Unit and can be used as an analog input module. <ul style="list-style-type: none"> • 2 analog inputs 0 to 10 V (Resolution: 1/4000) 0 to 20 mA (Resolution: 1/2000) | 0.02 A | --- | CP1W-ADB21 |
| Analog Output Option Board  | Mounted in the option slot of an N□□-type CPU Unit and can be used as an analog output module. <ul style="list-style-type: none"> • 2 analog outputs 0 to 10 V (Resolution: 1/4000) | 0.06 A | --- | CP1W-DAB21V |
| Analog Input/Output Option Board  | Mounted in the option slot of an N□□-type CPU Unit and can be used as an analog input/output module. <ul style="list-style-type: none"> • 2 analog inputs 0 to 10 V (Resolution: 1/4000) 0 to 20 mA (Resolution: 1/2000) • 2 analog outputs 0 to 10 V (Resolution: 1/4000) | 0.08 A | --- | CP1W-MAB221 |

- Note:**
1. Maximum one Analog Option Board can be mounted on an N□□-type CPU Unit.
 2. The CP1W-ME05M Memory Cassette, CP1W-DAM01 LCD Option Board, and CP1W-CIF41 Ethernet Option Board cannot be used with the CP2E CPU Unit.
 3. Option Boards cannot be used with the E/S□□-type CPU Unit.

Expansion I/O Units and Expansion Units (for E30/40/60, S30/40/60, or N30/40/60 CPU Units)

E14/20 or N14/20 CPU Units do not support Expansion I/O Units and Expansion Units.

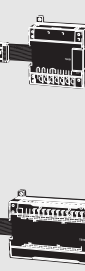
| Unit type | Product name | Specifications | | | Current consumption (A) | | Model | |
|--------------------------|--|----------------|---------|--|-------------------------|-------------|-------------|------------|
| | | Inputs | Outputs | Output type | 5 V | 24 V | | |
| CP1W Expansion I/O Units |  Input Unit | 8 | --- | 24 VDC Input | 0.018 | --- | CP1W-8ED | |
| |  Output Units | --- | 8 | Relay | 0.026 | 0.044 | CP1W-8ER | |
| | | | | Transistor (sinking) | 0.075 | --- | CP1W-8ET | |
| | | | | Transistor (sourcing) | 0.075 | --- | CP1W-8ET1 | |
| |  Output Units | --- | 16 | Relay | 0.042 | 0.090 | CP1W-16ER | |
| | | | | Transistor (sinking) | 0.076 | --- | CP1W-16ET | |
| | | | | Transistor (sourcing) | 0.076 | --- | CP1W-16ET1 | |
| |  Output Units | --- | 32 | Relay | 0.049 | 0.131 | CP1W-32ER | |
| | | | | Transistor (sinking) | 0.113 | --- | CP1W-32ET | |
| | | | | Transistor (sourcing) | 0.113 | --- | CP1W-32ET1 | |
| |  I/O Units | 12 | 8 | Relay | 0.103 | 0.044 | CP1W-20EDR1 | |
| | | | | Transistor (sinking) | 0.130 | --- | CP1W-20EDT | |
| | | | | Transistor (sourcing) | 0.130 | --- | CP1W-20EDT1 | |
| | | 24 | 16 | Relay | 0.080 | 0.090 | CP1W-40EDR | |
| Transistor (sinking) | | | | 0.160 | --- | CP1W-40EDT | | |
| Transistor (sourcing) | | | | 0.160 | --- | CP1W-40EDT1 | | |
| CP1W Expansion Units |  Analog Input Unit | 4CH | --- | Input range: 0 to 5 V, 1 to 5 V, 0 to 10 V, ±10 V, 0 to 20 mA, or 4 to 20 mA. | Resolution: 1/6000 | 0.100 | 0.090 | CP1W-AD041 |
| | | | | | Resolution: 1/12000 | 0.100 | 0.050 | CP1W-AD042 |
| |  Analog Output Unit | --- | 2CH | Output range: 1 to 5 V, 0 to 10 V, ±10 V, 0 to 20 mA, or 4 to 20 mA. | Resolution: 1/6000 | 0.040 | 0.095 | CP1W-DA021 |
| | | | | | Resolution: 1/6000 | 0.080 | 0.124 | CP1W-DA041 |
| | | | | | Resolution: 1/12000 | 0.070 | 0.160 | CP1W-DA042 |
| |  Analog I/O Unit | 4CH | 4CH | Input range: 0 to 5 V, 1 to 5 V, 0 to 10 V, ±10 V, 0 to 20 mA, or 4 to 20 mA. Output range: 1 to 5 V, 0 to 10 V, ±10 V, 0 to 20 mA, or 4 to 20 mA. | Resolution: 1/12000 | 0.120 | 0.170 | CP1W-MAD44 |
| | | | 2CH | | Resolution: 1/12000 | 0.120 | 0.120 | CP1W-MAD42 |
| | | | 1CH | | Resolution: 1/6000 | 0.083 | 0.110 | CP1W-MAD11 |
| |  Temperature Sensor Unit | 2CH | --- | Sensor type: Thermocouple (J or K) | 0.040 | 0.059 | CP1W-TS001 | |
| | | 4CH | --- | Sensor type: Thermocouple (J or K) | 0.040 | 0.059 | CP1W-TS002 | |
| | | 2CH | --- | Sensor type: Platinum resistance thermometer (Pt100 or JPt100) | 0.054 | 0.073 | CP1W-TS101 | |
| | | 4CH | --- | Sensor type: Platinum resistance thermometer (Pt100 or JPt100) | 0.054 | 0.073 | CP1W-TS102 | |
| | | 4CH | --- | Sensor type: Thermocouple (J or K) 2channels can be used as analog input. Input range: 1 to 5 V, 0 to 10 V, 4-20 mA | Resolution: 1/12000 | 0.070 | 0.030 | CP1W-TS003 |
| | | 12CH | --- | Sensor type: Thermocouple (J or K) | 0.080 | 0.050 | CP1W-TS004 | |

I/O Connecting Cable

| Product name | Specifications | Model |
|----------------------|--|------------|
| I/O Connecting Cable | 80 cm (for CP1W Expansion I/O Units and Expansion Units) Only one I/O Connecting Cable can be used in each PLC. | CP1W-CN811 |

DIN Track Accessories

| Name | Specifications | Model |
|-----------|---|-----------|
| DIN Track | Length: 0.5 m; Height: 7.3 mm | PFP-50N |
| | Length: 1 m; Height: 7.3 mm | PFP-100N |
| | Length: 1 m; Height: 16 mm | PFP-100N2 |
| End Plate | A stopper to secure the Units on the DIN Track. | PFP-M |

Programming Devices

Software

| Product name | Specifications | | | Model |
|---|--|--------------------|-------|-----------------------|
| | | Number of licenses | Media | |
| FA Integrated Tool Package CX-One Lite Ver.4.□ | CX-One Lite is a subset of the complete CX-One package that provides only the Support Software required for micro PLC applications. CX-One Lite runs on the following OS. OS: Windows XP (Service Pack 3 or higher, 32-bit version) / Windows Vista (32-bit/64-bit version) / Windows 7 (32-bit/64-bit version) / Windows 8 (32-bit/64-bit version) / Windows 8.1 (32-bit/64-bit version) / Windows 10 (32-bit/64-bit version) CX-One Lite Ver. 4.□ includes Micro PLC Edition CX-Programmer Ver.9.□. | 1 license | DVD | CXONE-LT01D-V4 |
| FA Integrated Tool Package CX-One Package Ver. 4.□ | CX-One is a comprehensive software package that integrates Support Software for OMRON PLCs and components. CX-One runs on the following OS. OS: Windows XP (Service Pack 3 or higher, 32-bit version) / Windows Vista (32-bit/64-bit version) / Windows 7 (32-bit/64-bit version) / Windows 8 (32-bit/64-bit version) / Windows 8.1 (32-bit/64-bit version) / Windows 10 (32-bit/64-bit version) CX-One Ver. 4.□ includes CX-Programmer Ver. 9.□. | 1 license *1 | DVD | CXONE-AL01D-V4 |

Note: 1. CP2E CPU Units are supported by CX-One version 4.51 or higher and CX-Programmer version 9.72 or higher.
2. The CX-One and CX-One Lite cannot be simultaneously installed on the same computer.
3. For details, refer to the CX-One Catalog (Cat. No. R134).

*1. Multi licenses (3, 10, 30, or 50 licenses) and DVD media without licenses are also available for the CX-One.

CP2E

General Specifications

| Item | AC power supply | DC power supply | |
|---------------------------|--|--|---|
| Model | CP2E-□□□□□-A | CP2E-□□□□□-D | |
| Enclosure | Mounted in a panel | | |
| Dimensions (H × D × W) | CPU Unit with 14 or 20 I/O points (CP2E-□14/20D□-□): 90mm *1 × 80mm *2 × 86mm CPU Unit with 30 I/O points (CP2E-□30D□-□): 90mm *1 × 80mm *2 × 130mm CPU Unit with 40 I/O points (CP2E-□40D□-□): 90mm *1 × 80mm *2 × 150mm CPU Unit with 60 I/O points (CP2E-□60D□-□): 90mm *1 × 80mm *2 × 195mm | | |
| Weight | CPU Unit with 14 I/O points (CP2E-□14D□-□): 335g max. CPU Unit with 20 I/O points (CP2E-□20D□-□): 340g max. CPU Unit with 30 I/O points (CP2E-□30D□-□): 580g max. CPU Unit with 40 I/O points (CP2E-□40D□-□): 640g max. CPU Unit with 60 I/O points (CP2E-□60D□-□): 780g max. | | |
| Electrical specifications | Supply voltage | 100 to 240 VAC 50/60 Hz | 24 VDC |
| | Operating voltage range | 85 to 264 VAC | 20.4 to 26.4 VDC |
| | Power consumption | 15 VA/100 VAC max. (CP2E-□14/20D□-A) 25 VA/240 VAC max. | 13W max. (CP2E-□14/20D□-D) |
| | | 50 VA/100 VAC max. (CP2E-□30/40/60D□-A) 70 VA/240 VAC max. | 20W max. (CP2E-□30/40/60D□-D) *4 |
| | Inrush current | 120 VAC, 20 A for 8 ms max. for cold start at room temperature 240 VAC, 40 A for 8 ms max. for cold start at room temperature | 24 VDC, 30A for 20 ms max. for cold start at room temperature |
| | External power supply *3 | Not provided. (CP2E-□14/20D□-A) 24 VDC, 300 mA (CP2E-□30/40/60D□-A) | Not provided. |
| | Insulation resistance | 20 MΩ min. (at 500 VDC) between the external AC terminals and GR terminals | Not isolated between primary and secondary DC power supplies |
| | Dielectric strength | 2,300 VAC 50/60Hz for 1 min between AC external and GR terminals Leakage current: 5 mA max. | Not isolated between primary and secondary DC power supplies |
| Power interrupt time | 10 ms min. | 2 ms min. | |
| Application environment | Ambient operating temperature | -20 to 60°C | |
| | Ambient humidity | 10% to 90% | |
| | Atmosphere | No corrosive gas. | |
| | Ambient storage temperature | -20 to 75°C (excluding battery) | |
| | Altitude | 2,000 m max. | |
| | Pollution degree | 2 or less: Conforms to IEC61010-2-201. | |
| | Noise resistance | 2 kV on power supply line (Conforms to IEC61000-4-4.) | |
| | Overvoltage category | Category II: Conforms to IEC61010-2-201. | |
| | EMC immunity level | Zone B | |
| | Vibration resistance | Conforms to IEC60068-2-6. 5 to 8.4 Hz with 3.5-mm amplitude, 8.4 to 150 Hz Acceleration of 9.8 m/s ² for 100 min in X, Y, and Z directions (10 sweeps of 10 min each = 100 min total) | |
| | Shock resistance | Conforms to IEC60068-2-27. 147 m/s ² , 3 times in X, Y, and Z directions | |
| Terminal block | Fixed (not removable) | | |
| Terminal screw size | M3 | | |
| Applicable standards | Conforms to EC Directives. | | |
| Grounding method | Ground to 100Ω or less. | | |

*1. Total of 110 mm with mounting brackets.

*2. Excluding cables.

*3. Use the external power supply to power input devices. Do not use it to drive output devices.

*4. This is the rated value for the maximum system configuration. Use the following formula to calculate power consumption for CPU Units with DC power.

Formula: DC power consumption = (5V current consumption × 5 V/70% (internal power efficiency) + 24V current consumption) × 1.1 (current fluctuation factor)

The above calculation results show that a DC power supply with a greater capacity is required.

Note: 1. The Expansion I/O Units and Expansion Units work under the same conditions as the CPU Units unless otherwise specified.

Performance Specifications

| Item | | CP2E-E□□□□□□□ | CP2E-S□□□□□□□ | CP2E-N□□□□□□□ | |
|---|-----------------------------|---|--|--|--|
| Program capacity | | 4K steps | 8K steps | 10K steps | |
| FB capacity | | 4K steps | 8K steps | 10K steps | |
| Control method | | Stored program method | | | |
| I/O control method | | Cyclic scan with immediate refreshing | | | |
| Program language | | Ladder diagram | | | |
| Function blocks | | Maximum number of function block definitions: 64 Maximum number of instances: 128 Languages usable in function block definitions: Ladder diagrams, structured text (ST) | | | |
| Instructions | | Approximately 220 | | | |
| Processing speed | Overhead processing time | 0.1 ms | 0.15 ms | 0.2 ms | |
| | Instruction execution times | LD 0.23 μs MOV 1.76 μs | | | |
| Number of CP1W-series Expansion I/O Units and Expansion Units connected | | CP2E-□14/20D□□□: None CP2E-□30/40/60D□□□: 3 units | | | |
| Maximum number of I/O points | | CP2E-□14D□□□: 14 CP2E-□20D□□□: 20 CP2E-□30D□□□: 150 (30 built in, 40 × 3 expansion) CP2E-□40D□□□: 160 (40 built in, 40 × 3 expansion) CP2E-□60D□□□: 180 (60 built in, 40 × 3 expansion) | | | |
| Built-in input function | High-speed counters | High-speed counter mode/maximum frequency | Incremental Pulse Inputs 100 kHz: 2 counters 10 kHz: 4 counters Up/Down Inputs 100 kHz: 1 counter 10 kHz: 1 counter Pulse + Direction Inputs 100 kHz: 2 counters Differential Phase Inputs (4x) 50 kHz: 1 counter 5 kHz: 1 counter | N14/20D□□□ Incremental Pulse Inputs 100 kHz: 2 counters 10 kHz: 4 counters Up/Down Inputs 100 kHz: 1 counter 10 kHz: 1 counter Pulse + Direction Inputs 100 kHz: 2 counters Differential Phase Inputs (4x) 50 kHz: 1 counter 5 kHz: 1 counter | |
| | | | | Counting mode | <ul style="list-style-type: none"> Linear mode Ring mode |
| | | | | Count value | 32 bits |
| | | | | Counter reset modes | <ul style="list-style-type: none"> Phase Z and software reset (excluding increment pulse input) Software reset |
| | | | | Control method | <ul style="list-style-type: none"> Target matching Range comparison |
| | Input interrupts | 6 inputs | | 8 inputs (6 inputs only for 14 I/O points) | |
| | | Interrupt input pulse width: 50 μs min. | | | |
| | Quick-response inputs | 6 inputs | | 8 inputs (6 inputs only for 14 I/O points) | |
| | | Input pulse width: 50 μs min. | | | |
| | Normal input | Input constants | Delays can be set in the PLC setup (0 to 32 ms, default: 8 ms). Set values: 0, 1, 2, 4, 8, 16, or 32 ms | | |

| Item | | CP2E-E□□□□□□□ | CP2E-S□□□□□□□ | CP2E-N□□□□□□□ | | | |
|------------------------------------|--|---|------------------------------------|--|---|--|------|
| Built-in output function | Pulse outputs (Models with transistor outputs only) | Pulse output | Pulse output function not included | Pulse + Direction Mode | | | |
| | | Frequency | | 1 Hz to 100kHz : 2 outputs | N14/20D□-□ 1 Hz to 100kHz: 2 outputs N30/40/60D□-□ 1 Hz to 100kHz: 4 outputs | | |
| | | Output mode | | <ul style="list-style-type: none"> Continuous mode (for speed control) Independent mode (for position control) | | | |
| | | Number of output pulses | | <ul style="list-style-type: none"> Relative coordinates: 0000 0000 to 7FFF FFFF hex (0 to 2147483647) Absolute coordinates: 8000 0000 to 7FFF FFFF hex (-2147483647 to 2147483647) | | | |
| | | Acceleration/ deceleration curves | | Trapezoidal acceleration and deceleration (Cannot perform S-curve acceleration and deceleration). | | | |
| | | Changing SVs during instruction execution | | Only target position can be changed. | | | |
| | | Origin searches | | Included | | | |
| | | Linear interpolation | | None | N14/20D□-□ 2 axes max. N30/40/60D□-□ 4 axes max. | | |
| | | Frequency | | PWM output function not included | 2.0 to 6,553.5 Hz (in increments of 0.1 Hz) with 1 output or 2 Hz to 32,000 Hz (in increments of 1 Hz) with 1 output | | |
| | | Duty factor | | | 0.0% to 100.0% (in increments of 0.1%) Accuracy: +1%/-0% at 2 Hz to 10,000 Hz and +5%/-0% at 10,000 Hz to 32,000 kHz | | |
| | | Output mode | | | Continuous Mode | | |
| | | Communications | | Peripheral USB port | Conforming to USB 2.0 B-type connector | | None |
| Transmission distance | 5 m max. | | | | | | |
| Built-in RS232C port | Interface: Conforming to EIA RS-232C | | None | | | | |
| | Transmission distance | | | 15 m max. | | | |
| | Communications method | | | Half duplex | | | |
| | Synchronization | | | Start-stop | | | |
| | Baud rate | | | 1.2, 2.4, 4.8, 9.6, 19.2, 38.4, 57.6, or 115.2 kbps | | | |
| Supported protocol | <ul style="list-style-type: none"> Host Link 1:N NT Link No-protocol mode Serial PLC Links (master, slave) Modbus-RTU Easy Master Modbus-RTU Slave | | | | | | |
| Built-in RS485 port (not isolated) | Interface: Conforming to EIA RS-485 | | None | | | | |
| | Transmission distance | | | 50 m max. | | | |
| | Communications method | | | Half duplex | | | |
| | Synchronization | | | Start-stop | | | |
| | Baud rate | None | | 1.2, 2.4, 4.8, 9.6, 19.2, 38.4, 57.6, or 115.2 kbps | | | |
| Supported protocol | <ul style="list-style-type: none"> Host Link 1:N NT Link No-protocol mode Serial PLC Links (master, slave) Modbus-RTU Easy Master Modbus-RTU Slave | | | | | | |

| Item | | CP2E-E□□□□□□□ | CP2E-S□□□□□□□ | CP2E-N□□□□□□□ | | |
|----------------|--------------------------|---------------------------------|---|--|------|---------------------------|
| Communications | Serial Option port | Number of Option Boards | None | N14/20D□□□ 1 Option Board N30/40/60D□□□□ 2 Option Boards | | |
| | | Number of serial communications | | N14/20D□□□ 2 ports max. N30/40/60D□□□□ 3 ports max. | | |
| | | Communications method | | Depends on Option Board | | |
| | | Synchronization | | Depends on Option Board | | |
| | | Baud rate | | 1.2, 2.4, 4.8, 9.6, 19.2, 38.4, 57.6, or 115.2 kbps | | |
| | | Mountable Option Boards | | Serial Communication Option Board with one port <ul style="list-style-type: none"> • One RS-232C port: CP1W-CIF01 (Start-stop) • One RS-422A/485 port (not isolated): CP1W-CIF11 (Start-stop) • One RS-422A/485 port (isolated): CP1W-CIF12-V1 (Start-stop) Serial Communication Option Board with two ports *1 <ul style="list-style-type: none"> • Two RS-232C ports: CP2W-CIFD1 (Start-stop) • One RS-232C port and one RS-485 port (isolated): CP2W-CIFD2 (Start-stop) • Two RS-485 ports (isolated): CP2W-CIFD3 (Start-stop) Analog Option Board *2 CP1W-MAB221/ADB21/DAB21V <p>*1. CP2W-CIFD□□ can only be mounted on option slot 1. *2. Maximum one Analog Option Board can be mounted on an N□□□-type CPU Unit.</p> | | |
| | | Compatible protocols | | <ul style="list-style-type: none"> • Host Link* • 1:N NT Link* • No-protocol mode • Serial PLC Links (master, slave) • Modbus-RTU Easy Master • Modbus-RTU Slave * PORT1 (EX) is not supported. | | |
| | | Ethernet | | Physical layer | None | 100/10BASE-TX (Auto-MDIX) |
| | | | | Media access method | | CSMA/CD |
| | | | | Modulation | | Baseband |
| | Baud rate | | 100BASE-TX: 100Mbit/s 10BASE-T: 10Mbit/s <ul style="list-style-type: none"> • Half/full auto-negotiation for each port • Link speed auto-sensing for each port | | | |
| | Transmission media | | 100BASE-TX <ul style="list-style-type: none"> • Unshielded twisted-pair (UDP) cable Categories: 5, 5e • Shielded twisted-pair (STP) cable Categories: 100Ω at 5, 5e 10BASE-T <ul style="list-style-type: none"> • Unshielded twisted-pair (UDP) cable Categories: 3, 4, 5, 5e • Shielded twisted-pair (STP) cable Categories: 100Ω at 3, 4, 5, 5e | | | |
| | Transmission distance | | 100 m (distance between switch and node) | | | |
| | Protocol | | TCP, UDP, APR, ICMP (ping only), SNMP, DNS | | | |
| | Applications | | FINS, Socket, SNMP, DNS (Client) | | | |
| | Number of Ethernet ports | | N14/20: 1 port N30/40/60: 2 ports | | | |
| | Ethernet switch | | Layer 2 switch * N14/20 is not supported. | | | |

| Item | CP2E-E□□□□□□□ | CP2E-S□□□□□□□ | CP2E-N□□□□□□□ |
|---|---|--|--|
| Number of tasks | 17 <ul style="list-style-type: none"> • 1 cyclic task • 16 interrupt tasks Scheduled interrupt task: Interrupt task 1 (fixed) Built-in input interrupt task: Interrupt task 2 to 9 (IN8 and IN9 can only be used in N20/30/40/60 CPU Units) High-speed counter interrupt task: Interrupt task 1 to 16 | | |
| Maximum subroutine number | 128 | | |
| Maximum jump number | 128 | | |
| Scheduled interrupt tasks | 1 interrupt task | | |
| Battery service life *With CP2W-BAT02 Battery (optional) | Battery cannot be mounted. | CP2W-BAT02 can be mounted. Maximum battery service life: 5 years Guaranteed Lifetime Ambient temperature is 60°C: 13,000 hours (approx. 1.5 years) Ambient temperature is 25°C: 43,000 hours (approx. 5 years) | |
| Clock | None | Supported. Accuracy (monthly deviation): -4.5 min to -0.5 min (ambient temperature: 60°C), -2.0 min to +2.0 min (ambient temperature: 25°C), -2.5 min to +1.5 min (ambient temperature: -20°C) | |
| Memory backup | Built-in Flash Memory | Ladder programs and parameters are automatically saved to built-in Flash Memory. A section of the Data Memory Area can be saved to the built-in Flash Memory. | |
| | Built-in non-volatile memory | Data Memory Area (D), Holding Area (H), Counter Area (C) and Auxiliary Area (A) are automatically saved to the built-in non-volatile memory. | |
| CIO Area | Input Bits | 1,600 bits (100 words): CIO 0.00 to CIO 99.15 (CIO 00 to CIO 99) | |
| | Output Bits | 1,600 bits (100 words): CIO 100.00 to CIO 199.15 (CIO 100 to CIO 199) | |
| | Serial PLC Link Words | 1,440 bits (90 words): CIO 200.00 to CIO 289.15 (CIO 200 to CIO 289) | |
| Work Area (W) | 2,048 bits (128 words): W0.00 to W127.15 (W0 to W127) | | |
| Holding Area (H) | 2,048 bits (128 words): H0.00 to H127.15 (H0 to 127) Words H512 to H1535: These words can be used only for function blocks. | | |
| Auxiliary Area (A) | Read-only: 7,168 bits (448 words): A0.00 to A447.15 (A0 to A447) Read/write: 8,192 bits (512 words): A448.00 to A959.15 (A448 to A959) | | |
| Temporary Area (TR) | 16 bits: TR0 to TR15 | | |
| Timer Area (T) | 256 timer numbers (T0 to T255 (separate from counters)) Words T256 to T511: These words can be used only for function blocks. | | |
| Counter Area (C) | 256 counter numbers (C0 to C255 (separate from timers)) Words C256 to C511: These words can be used only for function blocks. | | |
| Data Memory Area (D) | 4 K words: D0 to D4095 DM backup: 1,500 words (D0 to D1499) | 8 K words: D0 to D8191 DM backup: 7,000 words (D0 to D6999) | 16 K words: D0 to D16383 DM backup: 15,000 words (D0 to D14999) |
| Index Registers (IR) | 16 registers: IR0 to IR15 | | |
| Data Registers (DR) | 16 registers: DR0 to DR15 | | |
| Operating modes | PROGRAM Mode: Program execution is stopped. Preparations can be executed prior to program execution in this mode. MONITOR Mode: Programs are executed. Some operations, such as online editing, and changes to present values in I/O memory, are enabled in this mode. RUN Mode: Programs are executed. This is the normal operating mode. | | |

Internal Memory in the CPU Units

CPU Unit Memory Backup Structure

The internal memory in the CPU Unit consists of built-in RAM and built-in Flash Memory. The built-in RAM is used as execution memory and the built-in Flash Memory is used as backup memory.

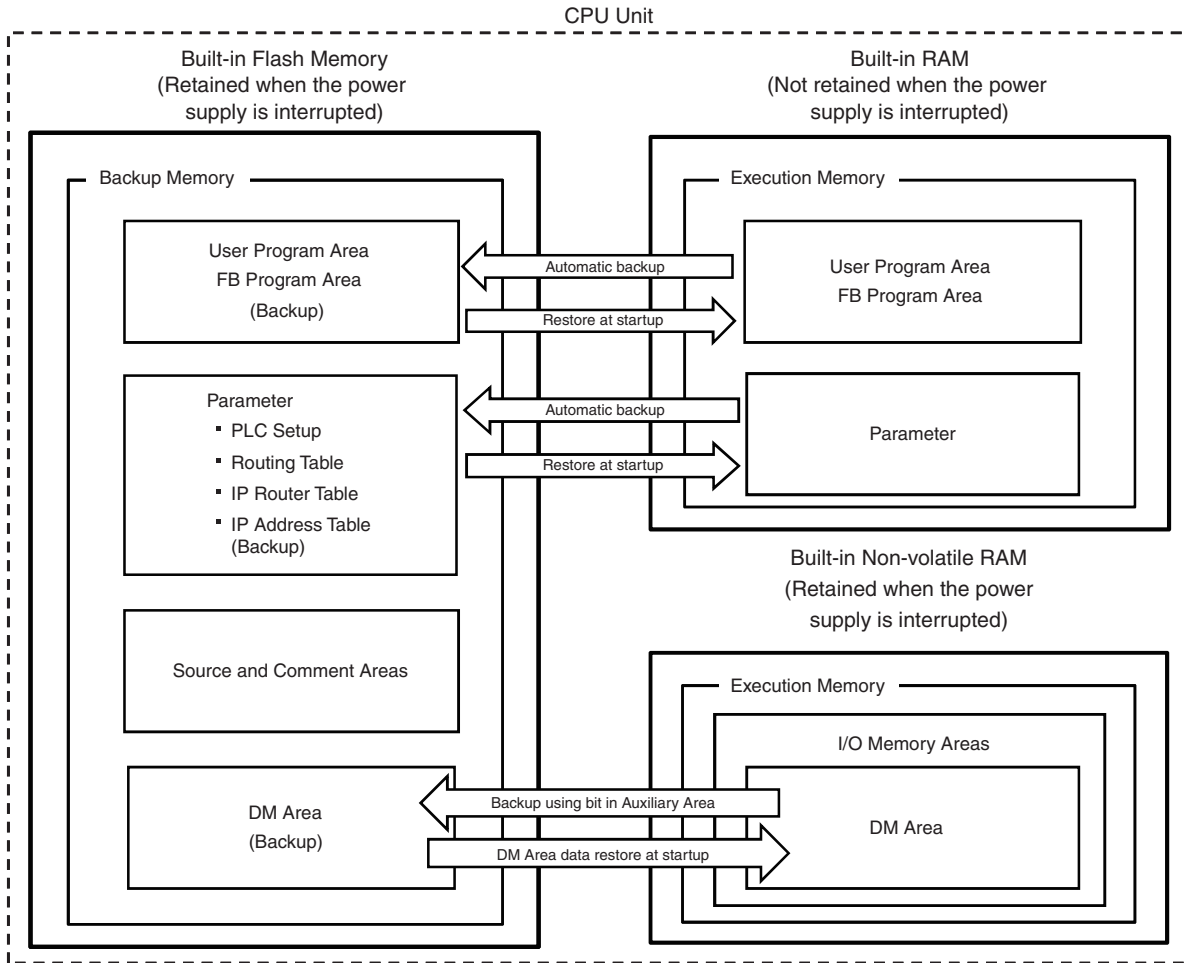

CP2E

Part Names and Functions

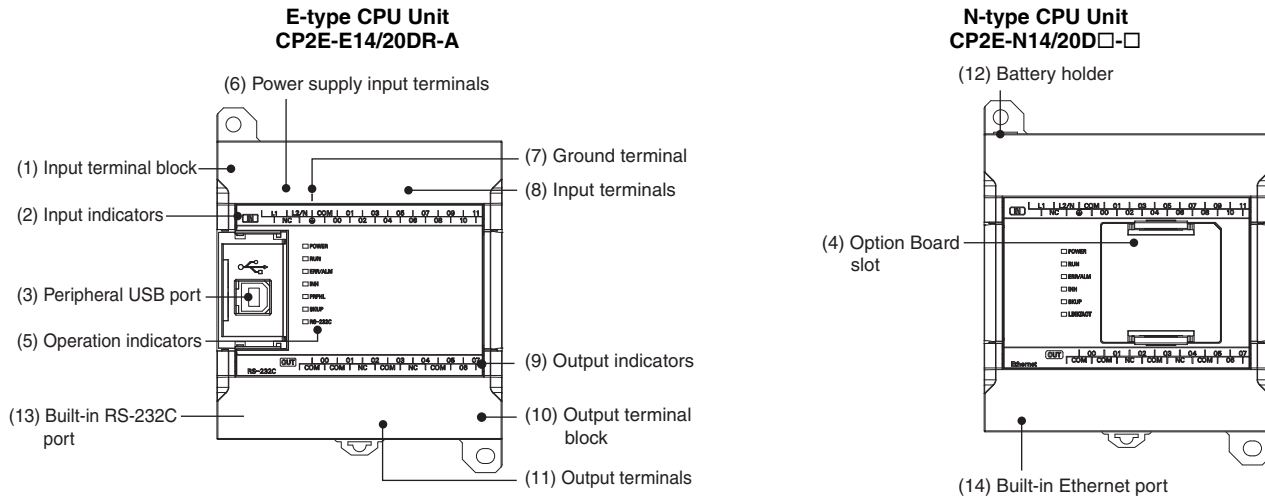

| Number | Name | Function |
|--------|---|---|
| (1) | Input terminal block (not removable) | This is the terminal block for inputs such as the power supply input and 24 VDC inputs. |
| (2) | Input indicators (yellow) | Input status is displayed. An indicator will be ON when the input is ON. |
| (3) | Peripheral USB port for E□□-type CPU Units | Used to connect to a personal computer for programming and monitoring by the CX-Programmer for CP2E. |
| (4) | Option Board slot for N□□-type CPU Units | An Option Board can be connected to the slot. <ul style="list-style-type: none"> • CP1W-CIF01 RS-232C Option Board • CP1W-CIF11 RS-422A/485 Option Board (Maximum transmission distance: 50 m) • CP1W-CIF12-V1 RS-422A/485 Option Board (Maximum transmission distance: 500 m) • CP1W-MAB221/ADB21/DAB21V Analog Option Board • CP2W-CIFD1 Option Board with two RS-232C ports • CP2W-CIFD2 Option Board with one RS-232C port and one RS-485 port (isolated) • CP2W-CIFD3 Option Board with two RS-485 ports (isolated) |
| (5) | Operation indicators | The CPU Unit's operating status can be confirmed with this indicator. |
| (6) | Power supply input terminals | Power of 100 to 240 VAC or 24 VDC can be supplied. |
| (7) | Ground terminal | Protective ground (⊕): To prevent electric shock, ground to 100 Ω or less. |
| (8) | Input terminals | Input devices such as switches and sensors can be connected. |
| (9) | Output indicators (yellow) | Output status is displayed. An indicator will be ON when the output is ON. |
| (10) | Output terminal block (not removable) | This is the terminal block for outputs such as relay outputs and transistor outputs. |
| (11) | Output terminals | Loads such as lamps, contactors, and solenoid valves can be connected. |
| (12) | Battery holder for N□□-type CPU Units | A Battery can be installed by opening the cover. (The Battery is optional.) |
| (13) | Built-in RS-232C port for E□□-type CPU Units | By connecting a PT, the controlled system can be monitored and data can be collected. |
| (14) | Built-in Ethernet port for N□□-type CPU Units | Used to connect to a personal computer for programming and monitoring by the CX-Programmer for CP2E, or connect to other OMRON PLCs for data exchange. |

E/S-type CPU Unit
CP2E-E30/40/60DR-A
CP2E-S30/40/60D□□

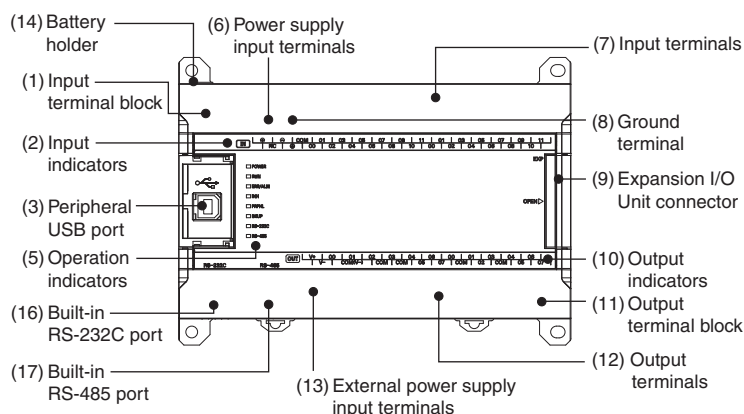

N-type CPU Unit
CP2E-N30/40/60D□□

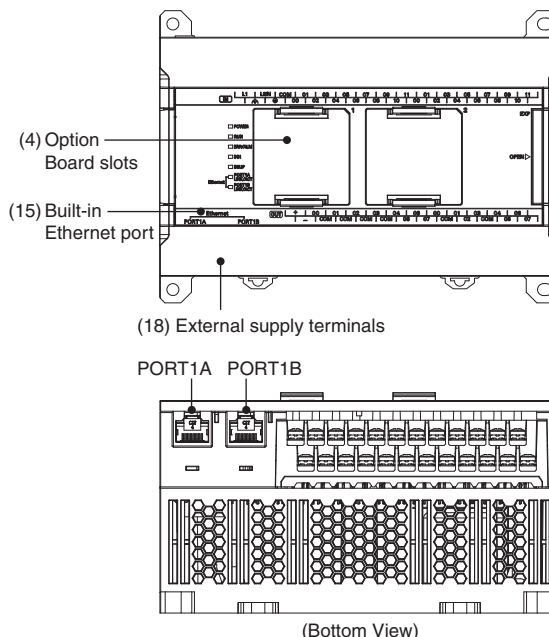

| Number | Name | Function |
|--------|--|---|
| (1) | Input terminal block (not removable) | This is the terminal block for inputs such as the power supply input and 24 VDC inputs. |
| (2) | Input indicators (yellow) | Input status is displayed. An indicator will be ON when the input is ON. |
| (3) | Peripheral USB port for E/S□□-type CPU Units | Used to connect to a personal computer for programming and monitoring by the CX-Programmer for CP2E. |
| (4) | Option Board slots for N□□-type CPU Units | Option Boards can be connected to the slots. <ul style="list-style-type: none"> • CP1W-CIF01 RS-232C Option Board • CP1W-CIF11 RS-422A/485 Option Board (Maximum transmission distance: 50 m) • CP1W-CIF12-V1 RS-422A/485 Option Board (Maximum transmission distance: 500 m) • CP1W-MAB221/ADB21/DAB21V Analog Option Board • CP2W-CIFD1 Option Board with two RS-232C ports • CP2W-CIFD2 Option Board with one RS-232C port and one RS-485 port (isolated) • CP2W-CIFD3 Option Board with two RS-485 ports (isolated) |
| (5) | Operation indicators | The CPU Unit's operating status can be confirmed with this indicator. |
| (6) | Power supply input terminals | Power of 100 to 240 VAC or 24 VDC can be supplied. |
| (7) | Input terminals | Input devices such as switches and sensors can be connected. |
| (8) | Ground terminal | Protective ground (⊕): To prevent electric shock, ground to 100 Ω or less. Functional ground (⊕): If noise is a significant source of errors or if electrical shock is a problem, connect to the protective ground terminal and ground both with a ground of 100Ω or less (AC power supply only). |
| (9) | Expansion I/O Unit connector | CP-series Expansion I/O Units or Expansion Units such as Analog I/O Units, and Temperature Sensor Units can be connected. |
| (10) | Output indicators (yellow) | Output status is displayed. An indicator will be ON when the output is ON. |
| (11) | Output terminal block (not removable) | This is the terminal block for outputs such as relay outputs, transistor outputs, and the external power supply output. |
| (12) | Output terminals | Loads such as lamps, contactors, and solenoid valves can be connected. |
| (13) | External power supply input terminals for S□□-type CPU Units | Power of 20.4V to 26.4 VDC can be supplied to CIO 100.00 and CIO 100.01. |
| (14) | Battery holder for N/S□□-type CPU Units | A Battery can be installed by opening the cover. (Battery is optional.) |
| (15) | Built-in Ethernet port for N□□-type CPU Units | Used to connect to a personal computer for programming and monitoring by the CX-Programmer for CP2E, or connect to other OMRON PLCs for data exchange. |
| (16) | Built-in RS-232C port for E/S□□-type CPU Units | By connecting a PT, the controlled system can be monitored and data can be collected. |
| (17) | Built-in RS-485 port for S□□-type CPU Units | Communications are possible between an inverter and a PLC by using Modbus-RTU and Serial PLC Links. |
| (18) | External supply terminals | The external supply terminals output up to 300 mA max at 24 VDC. They can be used as a service power supply for input devices (AC power supply only). |

CP2E

Built-in Inputs

Terminal Arrangements

●14 points

AC power supply

CP2E-□14D□-A

| | | | | | | | | | |
|-------|------|-----|----|----|----|----|----|----|--|
| CIO 0 | | | | | | | | | |
| L1 | L2/N | COM | 01 | 03 | 05 | 07 | NC | NC | |
| | | | 00 | 02 | 04 | 06 | NC | NC | |

L1,L2/N : Power supply terminal
 : Protective ground terminal
 COM : Common terminal
 00 to 07 : Input terminal
 NC : No connection

DC power supply

CP2E-N14D□-D

| | | | | | | | | | |
|-------|---|-----|----|----|----|----|----|----|--|
| CIO 0 | | | | | | | | | |
| + | - | COM | 01 | 03 | 05 | 07 | NC | NC | |
| | | | 00 | 02 | 04 | 06 | NC | NC | |

+,- : Power supply terminal
 : Protective ground terminal
 COM : Common terminal
 00 to 07 : Input terminal
 NC : No connection

●20 points

AC power supply

CP2E-□20D□-A

| | | | | | | | | | | |
|-------|------|-----|----|----|----|----|----|----|--|--|
| CIO 0 | | | | | | | | | | |
| L1 | L2/N | COM | 01 | 03 | 05 | 07 | 09 | 11 | | |
| | | | 00 | 02 | 04 | 06 | 08 | 10 | | |

L1,L2/N : Power supply terminal
 : Protective ground terminal
 COM : Common terminal
 00 to 11 : Input terminal
 NC : No connection

DC power supply

CP2E-N20D□-D

| | | | | | | | | | | |
|-------|---|-----|----|----|----|----|----|----|--|--|
| CIO 0 | | | | | | | | | | |
| + | - | COM | 01 | 03 | 05 | 07 | 09 | 11 | | |
| | | | 00 | 02 | 04 | 06 | 08 | 10 | | |



+,- : Power supply terminal
 : Protective ground terminal
 COM : Common terminal
 00 to 11 : Input terminal
 NC : No connection

●30 points

AC power supply

CP2E-□30D□-A

| | | | | | | | | | | | | | | |
|-------|------|-----|----|----|----|----|----|----|----|-------|----|----|--|--|
| CIO 0 | | | | | | | | | | CIO 1 | | | | |
| L1 | L2/N | COM | 01 | 03 | 05 | 07 | 09 | 11 | 01 | 03 | 05 | | | |
| | | | 00 | 02 | 04 | 06 | 08 | 10 | 00 | 02 | 04 | NC | | |

L1, L2/N : Power supply terminal
 COM : Common terminal
 00 to 11 : Input terminal
 : Functional ground terminal
 : Protective ground terminal
 NC : No connection

DC power supply

CP2E-□30D□-D

| | | | | | | | | | | | | | | |
|-------|---|-----|----|----|----|----|----|----|----|-------|----|----|--|--|
| CIO 0 | | | | | | | | | | CIO 1 | | | | |
| + | - | COM | 01 | 03 | 05 | 07 | 09 | 11 | 01 | 03 | 05 | | | |
| | | | 00 | 02 | 04 | 06 | 08 | 10 | 00 | 02 | 04 | NC | | |

+,- : Power supply terminal
 COM : Common terminal
 00 to 11 : Input terminal
 NC : No connection
 : Protective ground terminal

●40 points

AC power supply

CP2E-□40D□-A

| | | | | | | | | | | | | | | | | | | | | |
|-------|------|-----|----|----|----|----|----|----|----|-------|----|----|----|----|--|--|--|--|--|--|
| CIO 0 | | | | | | | | | | CIO 1 | | | | | | | | | | |
| L1 | L2/N | COM | 01 | 03 | 05 | 07 | 09 | 11 | 01 | 03 | 05 | 07 | 09 | 11 | | | | | | |
| | | | 00 | 02 | 04 | 06 | 08 | 10 | 00 | 02 | 04 | 06 | 08 | 10 | | | | | | |

DC power supply

CP2E-□40D□-D

| | | | | | | | | | | | | | | | | | | | | |
|-------|---|-----|----|----|----|----|----|----|----|-------|----|----|----|----|--|--|--|--|--|--|
| CIO 0 | | | | | | | | | | CIO 1 | | | | | | | | | | |
| + | - | COM | 01 | 03 | 05 | 07 | 09 | 11 | 01 | 03 | 05 | 07 | 09 | 11 | | | | | | |
| | | | 00 | 02 | 04 | 06 | 08 | 10 | 00 | 02 | 04 | 06 | 08 | 10 | | | | | | |

●60 points

AC power supply

CP2E-□60D□-A

| | | | | | | | | | | | | | | | | | | | | | | | | | | | | | | | | | | | | | | | | |
|-------|------|-----|----|----|----|----|----|----|----|-------|----|----|----|----|----|----|----|----|----|-------|--|--|--|--|--|--|--|--|--|--|--|--|--|--|--|--|--|--|--|--|
| CIO 0 | | | | | | | | | | CIO 1 | | | | | | | | | | CIO 2 | | | | | | | | | | | | | | | | | | | | |
| L1 | L2/N | COM | 01 | 03 | 05 | 07 | 09 | 11 | 01 | 03 | 05 | 07 | 09 | 11 | 01 | 03 | 05 | 07 | 09 | 11 | | | | | | | | | | | | | | | | | | | | |
| | | | 00 | 02 | 04 | 06 | 08 | 10 | 00 | 02 | 04 | 06 | 08 | 10 | 00 | 02 | 04 | 06 | 08 | 10 | | | | | | | | | | | | | | | | | | | | |

DC power supply

CP2E-□60D□-D

| | | | | | | | | | | | | | | | | | | | | | | | | | | | | | | | | | | | | | | | | |
|-------|---|-----|----|----|----|----|----|----|----|-------|----|----|----|----|----|----|----|----|----|-------|--|--|--|--|--|--|--|--|--|--|--|--|--|--|--|--|--|--|--|--|
| CIO 0 | | | | | | | | | | CIO 1 | | | | | | | | | | CIO 2 | | | | | | | | | | | | | | | | | | | | |
| + | - | COM | 01 | 03 | 05 | 07 | 09 | 11 | 01 | 03 | 05 | 07 | 09 | 11 | 01 | 03 | 05 | 07 | 09 | 11 | | | | | | | | | | | | | | | | | | | | |
| | | | 00 | 02 | 04 | 06 | 08 | 10 | 00 | 02 | 04 | 06 | 08 | 10 | 00 | 02 | 04 | 06 | 08 | 10 | | | | | | | | | | | | | | | | | | | | |

Allocating Built-in Input Terminals to Functions

Input terminals are allocated functions by setting parameters in the PLC Setup. Set the PLC Setup so that each terminal is used for only one function.

E20/30/40/60, S30/40/60 or N20/30/40/60 CPU Units

| Terminal block label | Terminal number | PLC Setup | | | | | | |
|----------------------|-----------------|---|----------------------|---------------------------|---|-----------------------------------|------------------------|--|
| | | Interrupt input settings on Built-in Input Tab Page | | | High-speed counter 0 to 5 settings on Built-in Input Tab Page | | | Origin search settings on Pulse Output 0 to 3 Tab Page |
| | | Normal | Interrupt | Quick | Use | | | Use |
| | | Normal input | Interrupt inputs | Quick-response inputs | Increment pulse input | Differential phase x4 or up/down | Pulse/direction | Origin search |
| CIO 0 | 00 | Normal input 0 | --- | --- | Counter 0, increment input | Counter 0, phase A or up input | Counter 0, pulse input | --- |
| | 01 | Normal input 1 | --- | --- | Counter 1, increment input | Counter 0, phase B or down input | Counter 1, pulse input | --- |
| | 02 | Normal input 2 | Interrupt input 2 | Quick-response input 2 | Counter 2, increment input | Counter 1, phase A or up input | Counter 0, direction | --- |
| | 03 | Normal input 3 | Interrupt input 3 | Quick-response input 3 | --- | Counter 1, phase B or down input | Counter 1, direction | --- |
| | 04 | Normal input 4 | Interrupt input 4 | Quick-response input 4 | Counter 3, increment input | Counter 0, phase Z or reset input | Counter 0, reset input | --- |
| | 05 | Normal input 5 | Interrupt input 5 | Quick-response input 5 | Counter 4, increment input | Counter 1, phase Z or reset input | Counter 1, reset input | --- |
| | 06 | Normal input 6 | Interrupt input 6 | Quick-response input 6 | Counter 5, increment input | --- | --- | Pulse 0, Origin input signal |
| | 07 | Normal input 7 | Interrupt input 7 | Quick-response input 7 | --- | --- | --- | Pulse 1, Origin input signal |
| | 08 | Normal input 8 | Interrupt input 8 *1 | Quick-response input 8 *1 | --- | --- | --- | Pulse 2, Origin input signal *2 |
| | 09 | Normal input 9 | Interrupt input 9 *1 | Quick-response input 9 *1 | --- | --- | --- | Pulse 3, Origin input signal *2 |
| | 10 | Normal input 10 | --- | --- | --- | --- | --- | Pulse 0, Origin proximity input signal |
| | 11 | Normal input 11 | --- | --- | --- | --- | --- | Pulse 1, Origin proximity input signal |
| CIO 1 | 00 | Normal input 12 | --- | --- | --- | --- | --- | Pulse 2, Origin proximity input signal *2 |
| | 01 | Normal input 13 | --- | --- | --- | --- | --- | Pulse 3, Origin proximity input signal *2 |
| | 02 to 11 | Normal input 14 to 23 | --- | --- | --- | --- | --- | --- |
| CIO 2 | 00 to 11 | Normal input 24 to 35 | --- | --- | --- | --- | --- | --- |

*1. Only supported by N□□-type CPU Units.

*2. Only supported by N30/40/60 CPU Units.

Note: 1. The same pulse inputs must be used for high-speed counter 0 and high-speed counter 1.

2. High-speed counter 2 cannot be used if the input setting of high-speed counter 0 or high-speed counter 1 is set for differential phase inputs (4x), pulse + direction inputs, or up/down pulse inputs.

E14 or N14 CPU Units

| Terminal block label | Terminal number | PLC Setup | | | | | | |
|----------------------|-----------------|---|-------------------|------------------------|---|-----------------------------------|------------------------|---|
| | | Interrupt input settings on Built-in Input Tab Page | | | High-speed counter 0 to 5 settings on Built-in Input Tab Page | | | Origin search settings on Pulse Output 0/1 Tab Page |
| | | Normal | Interrupt | Quick | Use | | | Use |
| | | Normal input | Interrupt inputs | Quick-response inputs | Increment pulse input | Differential phase x4 or up/down | Pulse/direction | Origin search |
| CIO 0 | 00 | Normal input 0 | --- | --- | Counter 0, increment input | Counter 0, phase A or up input | Counter 0, pulse input | --- |
| | 01 | Normal input 1 | --- | --- | Counter 1, increment input | Counter 0, phase B or down input | Counter 1, pulse input | --- |
| | 02 | Normal input 2 | Interrupt input 2 | Quick-response input 2 | Counter 2, increment input | Counter 1, phase A or up input | Counter 0, direction | --- |
| | 03 | Normal input 3 | Interrupt input 3 | Quick-response input 3 | --- | Counter 1, phase B or down input | Counter 1, direction | Pulse 0, Origin proximity input signal |
| | 04 | Normal input 4 | Interrupt input 4 | Quick-response input 4 | Counter 3, increment input | Counter 0, Phase Z or reset input | Counter 0, reset input | --- |
| | 05 | Normal input 5 | Interrupt input 5 | Quick-response input 5 | Counter 4, increment input | Counter 1, Phase Z or reset input | Counter 1, reset input | Pulse 1, Origin proximity input signal |
| | 06 | Normal input 6 | Interrupt input 6 | Quick-response input 6 | Counter 5, increment input | --- | --- | Pulse 0, Origin input signal |
| | 07 | Normal input 7 | Interrupt input 7 | Quick-response input 7 | --- | --- | --- | Pulse 1, Origin input signal |

Note: 1. The same pulse inputs must be used for high-speed counter 0 and high-speed counter 1.

2. High-speed counter 2 cannot be used if the input setting of high-speed counter 0 or high-speed counter 1 is set for differential phase inputs (4x), pulse + direction inputs, or up/down pulse inputs.

CP2E

Built-in Outputs

Terminal Arrangements

●14 points

AC/DC power supply

CP2E-□14D□-□

| | | | | | | |
|-----|-----|----|-----|----|-----|----|
| 00 | 01 | 02 | 03 | 04 | 05 | NC |
| COM | COM | NC | COM | NC | COM | NC |

CIO 100

COM : Common terminal
00 to 05 : Output terminal
NC : No connection

●20 points

AC/DC power supply

CP2E-□20D□-□

| | | | | | | |
|-----|-----|----|-----|----|-----|----|
| 00 | 01 | 02 | 03 | 04 | 05 | 07 |
| COM | COM | NC | COM | NC | COM | 06 |

CIO 100

COM : Common terminal
00 to 07 : Output terminal
NC : No connection

●30 points

AC power supply

CP2E-□30D□-A

| | | | | | | | | | |
|---|-----|-----|-----|----|-----|----|-----|----|----|
| + | 00 | 01 | 02 | 04 | 05 | 07 | 00 | 02 | |
| - | COM | COM | COM | 03 | COM | 06 | COM | 01 | 03 |

CIO 100

CIO 101

+, - : External supply terminal
COM : Common terminal
00 to 07 : Output terminal

DC power supply

CP2E-N30D□-D

| | | | | | | | | | |
|----|-----|-----|-----|----|-----|----|-----|----|----|
| NC | 00 | 01 | 02 | 04 | 05 | 07 | 00 | 02 | |
| NC | COM | COM | COM | 03 | COM | 06 | COM | 01 | 03 |

CIO 100

CIO 101

NC : No connection
COM : Common terminal
00 to 07 : Output terminal

CP2E-S30DT-D

| | | | | | | | | |
|----|---------|-----|----|-----|----|-----|----|----|
| V+ | 00 | 01 | 02 | 04 | 05 | 07 | 00 | 02 |
| V- | COM(V-) | COM | 03 | COM | 06 | COM | 01 | 03 |

CIO 100

CIO 101

COM : Common terminal
00-07 : Output terminal
V+ : External power supply input terminal for CIO 100.00/01 (DC24V)
V- : External power supply input terminal for CIO 100.00/01 (0V)

Note: COM(V-) has been connected with V- in an inner circuit.

CP2E-S30DT1-D

| | | | | | | | | |
|----|---------|-----|----|-----|----|-----|----|----|
| V+ | 00 | 01 | 02 | 04 | 05 | 07 | 00 | 02 |
| V- | COM(V+) | COM | 03 | COM | 06 | COM | 01 | 03 |

CIO 100

CIO 101

Note: COM(V+) has been connected with V+ in an inner circuit.

●40 points

AC power supply

CP2E-□40D□-A

| | | | | | | | | | | | |
|---|-----|-----|-----|-----|----|----|-----|----|-----|----|----|
| + | 00 | 01 | 02 | 03 | 04 | 06 | 00 | 01 | 03 | 04 | 06 |
| - | COM | COM | COM | COM | 05 | 07 | COM | 02 | COM | 05 | 07 |

CIO 100

CIO 101

DC power supply

CP2E-N40D□-D

| | | | | | | | | | | | |
|----|-----|-----|-----|-----|----|----|-----|----|-----|----|----|
| NC | 00 | 01 | 02 | 03 | 04 | 06 | 00 | 01 | 03 | 04 | 06 |
| NC | COM | COM | COM | COM | 05 | 07 | COM | 02 | COM | 05 | 07 |

CIO 100

CIO 101

CP2E-S40DT-D

| | | | | | | | | | | | |
|----|---------|-----|-----|----|----|-----|----|-----|----|----|----|
| V+ | 00 | 01 | 02 | 03 | 04 | 06 | 00 | 01 | 03 | 04 | 06 |
| V- | COM(V-) | COM | COM | 05 | 07 | COM | 02 | COM | 05 | 07 | |

CIO 100

CIO 101

Note: COM(V-) has been connected with V- in an inner circuit.

CP2E-S40DT1-D

| | | | | | | | | | | | |
|----|---------|-----|-----|----|----|-----|----|-----|----|----|----|
| V+ | 00 | 01 | 02 | 03 | 04 | 06 | 00 | 01 | 03 | 04 | 06 |
| V- | COM(V+) | COM | COM | 05 | 07 | COM | 02 | COM | 05 | 07 | |

CIO 100

CIO 101

Note: COM(V+) has been connected with V+ in an inner circuit.

●60 points

AC power supply

CP2E-□60D□-A

| | | | | | | | | | | | | | | | | |
|---------|-----|-----|-----|---------|-----|----|-----|---------|----|-----|----|-----|----|----|-----|----|
| + | 00 | 01 | 02 | 04 | 05 | 07 | 00 | 02 | 04 | 05 | 07 | 00 | 02 | 04 | 05 | 07 |
| - | COM | COM | COM | 03 | COM | 06 | COM | 01 | 03 | COM | 06 | COM | 01 | 03 | COM | 06 |
| CIO 100 | | | | CIO 101 | | | | CIO 102 | | | | | | | | |

DC power supply

CP2E-N60D□-D

| | | | | | | | | | | | | | | | | |
|---------|-----|-----|-----|---------|-----|----|-----|---------|----|-----|----|-----|----|----|-----|----|
| NC | 00 | 01 | 02 | 04 | 05 | 07 | 00 | 02 | 04 | 05 | 07 | 00 | 02 | 04 | 05 | 07 |
| NC | COM | COM | COM | 03 | COM | 06 | COM | 01 | 03 | COM | 06 | COM | 01 | 03 | COM | 06 |
| CIO 100 | | | | CIO 101 | | | | CIO 102 | | | | | | | | |

CP2E-S60DT-D

| | | | | | | | | | | | | | | | | |
|---------|---------|-----|----|---------|----|-----|----|---------|-----|----|-----|----|----|-----|----|----|
| V+ | 00 | 01 | 02 | 04 | 05 | 07 | 00 | 02 | 04 | 05 | 07 | 00 | 02 | 04 | 05 | 07 |
| V- | COM(V-) | COM | 03 | COM | 06 | COM | 01 | 03 | COM | 06 | COM | 01 | 03 | COM | 06 | |
| CIO 100 | | | | CIO 101 | | | | CIO 102 | | | | | | | | |

Note: COM(V-) has been connected with V- in an inner circuit.

CP2E-S60DT1-D

| | | | | | | | | | | | | | | | | |
|---------|---------|-----|----|---------|----|-----|----|---------|-----|----|-----|----|----|-----|----|----|
| V+ | 00 | 01 | 02 | 04 | 05 | 07 | 00 | 02 | 04 | 05 | 07 | 00 | 02 | 04 | 05 | 07 |
| V- | COM(V+) | COM | 03 | COM | 06 | COM | 01 | 03 | COM | 06 | COM | 01 | 03 | COM | 06 | |
| CIO 100 | | | | CIO 101 | | | | CIO 102 | | | | | | | | |

Note: COM(V+) has been connected with V+ in an inner circuit.

Allocating Built-in Output Terminals to Functions

Output terminals are allocated functions by setting parameters in the PLC Setup. Set the PLC Setup so that each terminal is used for only one function.

| Output terminal block | | Other than those shown at the right | When a pulse output instruction (ITPL, SPED, ACC, PLS2, or ORG) is executed | PLC Setup | When the PWM instruction is executed |
|-----------------------|-----------------|-------------------------------------|---|--|--------------------------------------|
| Terminal block label | Terminal number | Normal outputs | Fixed duty ratio pulse output | | Variable-duty-factor output |
| | | | Pulse + Direction Mode | Use | PWM output |
| CIO 100 | 00 | Normal output 0 | Pulse output 0, pulse | --- | --- |
| | 01 | Normal output 1 | Pulse output 1, pulse | --- | PWM output 0 |
| | 02 | Normal output 2 | Pulse output 0, direction | --- | --- |
| | 03 | Normal output 3 | Pulse output 1, direction | --- | --- |
| | 04 | Normal output 4 | --- | Pulse 0, Error counter reset output | --- |
| | 05 | Normal output 5 | --- | Pulse 1, Error counter reset output | --- |
| | 06 | Normal output 6 | --- | Pulse 2, Error counter reset output *1 | --- |
| | 07 | Normal output 7 | --- | Pulse 3, Error counter reset output *1 | --- |
| CIO 101 | 00 | Normal output 0 | Pulse output 2, pulse *1 | --- | --- |
| | 01 | Normal output 1 | Pulse output 3, pulse *1 | --- | --- |
| | 02 | Normal output 2 | Pulse output 2, direction *1 | --- | --- |
| | 03 | Normal output 3 | Pulse output 3, direction *1 | --- | --- |
| | 04 to 07 | Normal output 12 to 15 | --- | --- | --- |
| CIO 102 | 00 to 07 | Normal output 16 to 23 | --- | --- | --- |

*1. Only supported by N30/40/60 CPU Units.

Specifications

| Item | | Specification | | |
|-----------------------|------------------------------|--|---|--|
| Input type | | High-speed counter inputs or normal inputs | High-speed counter inputs, interrupt inputs, quick-response inputs or normal inputs | Normal inputs |
| Input bits | E/S□□-type and N14 CPU Units | CIO 0.00 and CIO 0.01 | CIO 0.02 to CIO 0.07 | CIO 0.08 to CIO 0.11, CIO 1.00 to CIO 1.11 and CIO 2.00 to CIO 2.11 *1 |
| | N20 CPU Units | CIO 0.00 and CIO 0.01 | CIO 0.02 to CIO 0.09 | CIO 0.10 to CIO 0.11 |
| | N30/40/60 CPU Units | CIO 0.00 to CIO 0.03 | CIO 0.04 to CIO 0.09 | CIO 0.10, CIO 0.11, CIO 1.00 to CIO 1.11 and CIO 2.00 to CIO 2.11 *1 |
| Applicable inputs | | 2-wire and 3-wire sensors | | |
| Input voltage | | 24 VDC, +10% / -15% | | |
| Input impedance | | 3.3 kΩ | 3.3 kΩ | 4.8 kΩ |
| Input current | | 7.5 mA (typical) | 7.5 mA (typical) | 5 mA (typical) |
| ON voltage/current | | 17.0 VDC min. / 3 mA min. | 17.0 VDC min. / 3 mA min. | 14.4 VDC min. / 3 mA min. |
| OFF voltage/current | | 5.0 VDC max. / 1 mA max. | 5.0 VDC max. / 1 mA max. | 5.0 VDC max. / 1 mA max. |
| ON response time *2 | | 2.5 μs min. | 50 μs max. | 1 ms max. |
| OFF response time *2 | | 2.5 μs min. | 50 μs max. | 1 ms max. |
| Circuit configuration | | | | |

*1. The bits that can be used depend on the model of CPU Unit.

*2. The response time is the delay caused by hardware. The delay set in the PLC Setup (0 to 32 ms, default: 8 ms) for a normal input must be added to this value.

- Interrupt input mode
- Pulse plus direction input mode
- Increment mode
- Up/down input mode

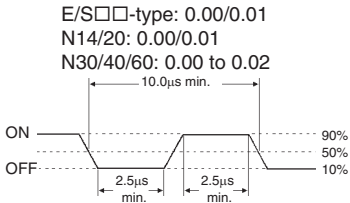

Differential phase mode

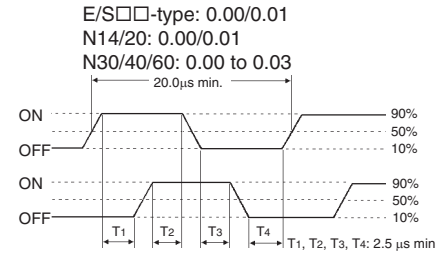

- E/S□□-type: 0.02 to 0.07
N14: 0.02 to 0.07
N20: 0.02 to 0.09
N30/40/60: 0.04 to 0.09

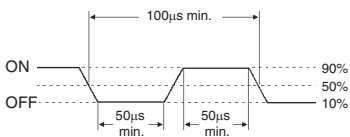

- E/S□□-type: 0.02/0.03
N14/20: 0.02/0.03

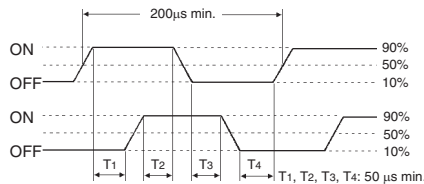

Output Specifications for Relay Outputs

CP2E-□□□DR-□

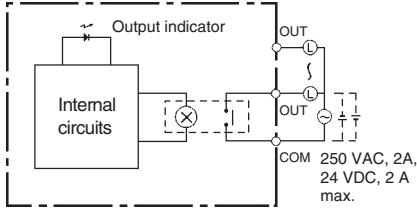
| Item | | Specification | |
|----------------------------|------------|--|---|
| Maximum switching capacity | | 2 A 250 VAC (cosφ= 1) 2 A 24 VDC (4 A/common) | |
| Minimum switching capacity | | 10 mA 5 VDC | |
| Service life of relay | Electrical | Resistive load | 200,000 operations (24 VDC) |
| | | Inductive load | 70,000 operations (250 VAC, cosφ = 0.4) |
| | Mechanical | 20,000,000 operations | |
| ON response time | | 15 ms max. | |
| OFF response time | | 15 ms max. | |
| Circuit configuration | |  | |

Estimating the Service Life of Relays

Under normal conditions, the service life of output contacts is as shown above. The service life of relays is as shown in the following diagram as a guideline.

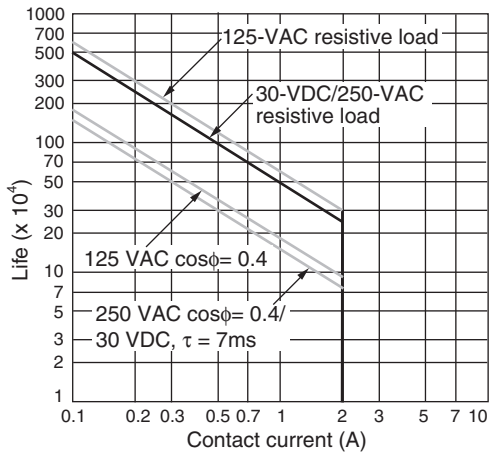

Output Specifications for Transistor Outputs (Sinking or Sourcing)

CP2E-N14/20/30/40/60DT(1)-□, CP2E-S30/40/60DT(1)-□

Normal Outputs

| Item | Specification | |
|----------------------------|---|---|
| | S□□-type: CIO 100.00 and CIO 100.01 N□□-type: CIO 100.00, CIO 100.01, CIO 101.00 and CIO 101.01 | S□□-type: CIO 100.02 to CIO 102.07 *2 N□□-type: CIO 100.02 to CIO 100.07, CIO 101.02 to CIO 102.07 *2 |
| Maximum switching capacity | 0.3 A/output, 0.9 A/common *1 4.5 to 30 VDC CP2E-N14D□-□: 1.5 A/Unit CP2E-N20D□-□: 1.8 A/Unit CP2E-S/N30D□-□: 2.7 A/Unit | CP2E-S/N40D□-□: 3.6 A/Unit CP2E-S/N60D□-□: 5.4 A/Unit |
| Minimum switching capacity | 1 mA 4.5 to 30 VDC | |
| Leakage current | 0.1 mA max. | |
| Residual voltage | 0.6 V max. | 1.5V max. |
| ON response time | 0.1 ms max. | 0.1 ms max. |
| OFF response time | 0.1 ms max. | 1 ms max. |
| Fuse | Not provided. | |
| External power supply | 20.4 to 26.4VDC 30mA max. (N□□-type is not needed) | Not needed |
| Circuit configuration | <p>• S□□-type CPU Unit</p> <p>Sinking output model</p> <p>Sourcing output model</p> <p>• N□□-type CPU Unit</p> <p>Sinking output model</p> <p>Sourcing output model</p> | |

*1. Also do not exceed 0.9 A for the total of CIO 100.00 to CIO 100.03, which are different common.

*2. The bits that can be used depend on the model of CPU Unit.

Note: 1. Do not connect a load to an output terminal or apply a voltage in excess of the maximum switching capacity.

Pulse Outputs

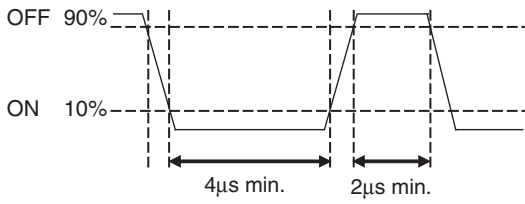
| Item | Specification |
|----------------------------|--|
| | S□□-type: CIO 100.00 and CIO 100.01 N□□-type: CIO 100.00, CIO 100.01, CIO 101.00 and CIO 101.01 |
| Maximum switching capacity | 100 mA 4.5 to 26.4 VDC |
| Minimum switching capacity | 7 mA 4.5 to 26.4 VDC |
| Maximum output frequency | 100 kHz |
| Output waveform |  <p>The OFF and ON refer to the output transistor. The output transistor is ON at level "L".</p> |

- Note:**
1. The load for the above values is assumed to be the resistive load, and does not take into account the impedance for the connecting cable to the load.
 2. Due to distortions in pulse waveforms resulting from connecting cable impedance, the pulse widths in actual operation may be smaller than the values shown above.

PWM Output (CIO 100.01)

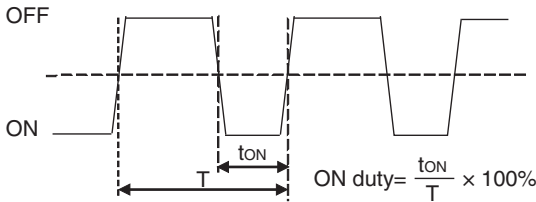
| Item | Specification |
|--------------------------|--|
| | Maximum switching capacity |
| Maximum output frequency | 32 kHz |
| PWM output accuracy | For ON duty +1%, -0%: 10 kHz output For ON duty +5%, -0%: 0 to 32 kHz output |
| Output waveform |  <p>The OFF and ON refer to the output transistor. The output transistor is ON at level "L".</p> |

CP2E

Built-in Ethernet

General Specifications (Ethernet)

| Item | | Specifications | |
|--------------------------|---------------------|--|--|
| | | 100BASE-TX (Auto-MDIX) | 10BASE-T (Auto-MDIX) |
| Type | | | |
| Number of Ethernet ports | | N14/20 CPU Units: 1 port N30/40/60 CPU Units: 2 ports (Switching Hub function is built in.) | |
| Transfer | Media access method | CSMA/CD | |
| | Modulation method | Baseband | |
| | Transmission paths | Star form | |
| | Baud rate | 100 Mbit/s (100Base-TX) Auto-Negotiation • Half/full auto-negotiation for each port • Link speed auto-sensing for each port | 10 Mbit/s (10Base-T) Auto-Negotiation |
| | Transmission media | <ul style="list-style-type: none"> Unshielded twisted-pair (UDP) cable Categories: 5, 5e Shielded twisted-pair (STP) cable Categories: 100Ω at 5, 5e | <ul style="list-style-type: none"> Unshielded twisted-pair (UDP) cable Categories: 3, 4, 5, 5e Shielded twisted-pair (STP) cable Categories: 100Ω at 3, 4, 5, 5e |
| Transmission distance | | 100 m (distance between hub and node) | |
| Protocols | | TCP, UDP, ARP, ICMP (ping only), SNMP, DNS | |

FINS Communications Service Specifications

| Item | Specification | |
|-----------------------|--|--|
| | FINS/UDP | FINS/TCP |
| Protocol name | | |
| Number of nodes | 254 | |
| Message Length | 1016 bytes max. | |
| Date Length | 1004 bytes max. | |
| Number of buffer | 16 | |
| Protocol used | UDP/IP | TCP/IP |
| | The selection of UDP/IP or TCP/IP is made by means of the FINS/UDP or FINS/TCP button in Built-in Ethernet Tab in the CX-Programmer's PLC Setup. | |
| Number of connections | --- | 3 for user, 1 for CX-Programmer auto connection |
| Port number | 9600 (default) Can be changed. | 9600 (default) Can be changed. |
| Protection | No | Yes (Specification of client IP addresses when unit is used as a server) |
| Local IP address | 192.168.250.FINS node address | |

Switching Hub for CP2E N□□-type CPU Units

| | |
|------------------------------|----------------------|
| Ethernet | 100Base-TX, 10Base-T |
| Auto MID/MID-X | Yes |
| Auto negotiation | Yes |
| Store-and-forward system | Yes |
| Buffer | 32K bytes |
| MAC address | 1000 |
| Broadcast storm detection | Yes |
| QoS | No |
| SNMP | No |
| VLAN | No |
| IGMP snooping | No |
| STP (Spanning Tree Protocol) | No |
| Port mirroring | No |

Serial Communication

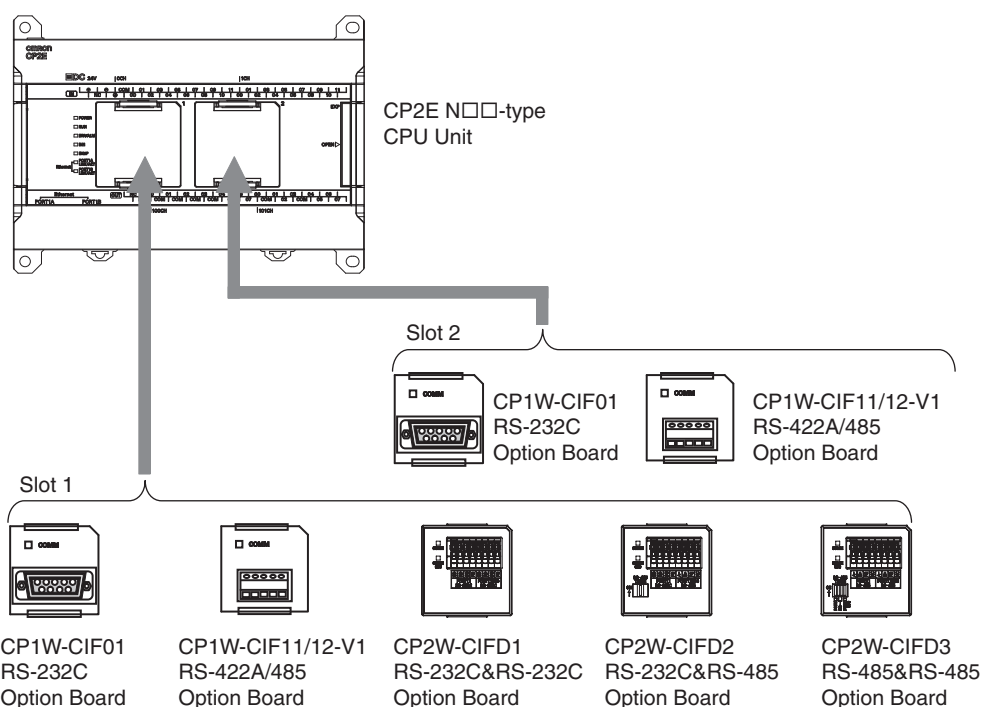

Note: 1. CP2W-CIFD□ can only be mounted on option slot 1.

Serial Communication Option Board

| Model numbers | Port | Maximum transmission distance | Connection method |
|---------------|---|--------------------------------|---------------------------------|
| CP1W-CIF01 | One RS-232C port | 15m | Connector (D-sub, 9 pin female) |
| CP1W-CIF11 | One RS-422A/485 port (not isolated) | 50m | Terminal block (using ferrules) |
| CP1W-CIF12-V1 | One RS-422A/485 port (isolated) | 500m | Terminal block (using ferrules) |
| CP2W-CIFD1 | Two RS-232C Ports | 15m | Terminal block (using ferrules) |
| CP2W-CIFD2 | One RS-232C port and one RS-485 port (isolated) | 15m (RS-232C) 500m (RS-485) | Terminal block (using ferrules) |
| CP2W-CIFD3 | Two RS-485 ports (isolated) | 500m | Terminal block (using ferrules) |

Built-in RS-232C Port for E/S□□-type CPU Units



| Pin | Abbr. | Signal Name | Signal direction |
|-----|---------|-----------------|------------------|
| 1 | SD(TXD) | Send data | Output |
| 2 | RD(RXD) | Receive data | Input |
| 3 | RS(RTS) | Request to send | Output |
| 4 | CS(CTS) | Clear to send | Input |
| 5 | SG(0V) | Signal ground | - |
| 6 | FG | Frame ground | - |

Built-in RS-485 Port (2-wire) for S□□-type CPU Units

RS-485 Terminal Block



| Pin | Abbr. | Signal Name | Signal direction |
|-----|-------|---------------------|------------------|
| 1 | A- | Send/Receive data - | - |
| 2 | B+ | Send/Receive data + | - |
| 3 | FG | Frame ground | - |

DIP Switch for Terminating Resistance Settings

| Setting | | | Terminating resistance selection Resistance value: 220 Ω typical |
|--|-----|-----|---|
| ON↑  | ON | OFF | |
| | OFF | OFF | |

CP1W-CIF01 RS-232C Option Board

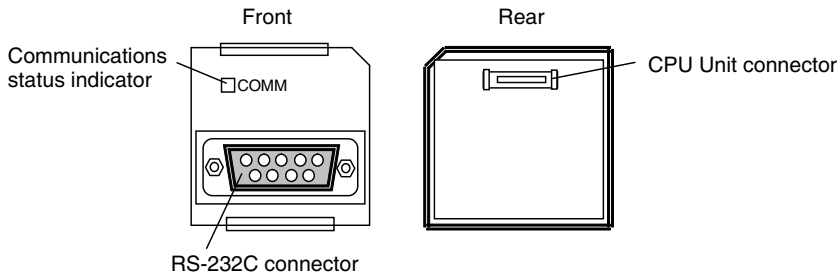

RS-232C Connector

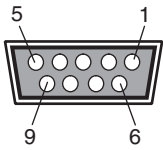

| Pin | Abbr. | Signal | Signal direction |
|----------------|---------|---------------------|------------------|
| 1 | FG | Frame ground | - |
| 2 | SD(TXD) | Send data | Output |
| 3 | RD(RXD) | Receive data | Input |
| 4 | RS(RTS) | Request to send | Output |
| 5 | CS(CTS) | Clear to send | Input |
| 6 | 5V | Power | - |
| 7 | DR(DSR) | Data set ready | Input |
| 8 | ER(DTR) | Data terminal ready | Output |
| 9 | SG(0V) | Signal ground | - |
| Connector hood | FG | Frame ground | - |

Note: 1. The NV3W-M□20L-V1 Programmable Terminal can be connected to pin 6 (+5V) on the RS-232C Option Board (CP1W-CIF01) mounted to the CPU Unit. Do not connect pin 6 to any other device.

CP1W-CIF11/CIF12-V1 RS-422A/485 Option Board

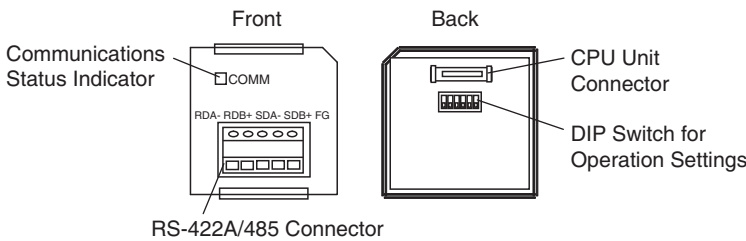

RS-422A/485 Terminal Block

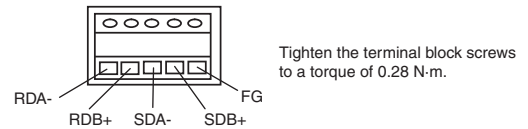

DIP Switch for Operation Settings

| SW | CP1W-CIF11 | | CP1W-CIF12-V1 | | Setting | | |
|----|------------|-----|--------------------|-------------------------------|-----------|--|--|
| | Pin | | Pin | | | | |
| | 1 | SW1 | | 1 | ON | ON (both ends) | Terminating resistance selection Resistance value: 220Ω typical |
| | | | | 1 | OFF | OFF | |
| | | | | 2 | ON | 2-wire connections | 2-wire or 4-wire selection *1 |
| | | | | 2 | OFF | 4-wire connections | |
| | 3 | ON | 2-wire connections | 2-wire or 4-wire selection *1 | | | |
| | 3 | OFF | 4-wire connections | | | | |
| 4 | - | - | - | - | Not used. | | |
| 5 | SW2 | | | 1 | ON | RS control enabled | RS control selection for RD *2 |
| | | | | 1 | OFF | RS control disabled (Data always received.) | |
| | | | | 2 | ON | RS control enabled | RS control selection for SD *3 |
| | | | | 2 | OFF | RS control disabled (Data always sent.) | |

*1. Set both pins 2 and 3 to either ON (2-wire) or OFF (4-wire).

*2. To disable the echo-back function, set pin 5 to ON (RS control enabled).

*3. When connecting to a device on the N side in a 1: N connection with the 4-wire method, set pin 6 to ON (RS control enabled). Also, when connecting by the 2-wire method, set pin 6 to ON (RS control enabled).

CP2W-CIFD1 RS-232C&RS-232C Option Board

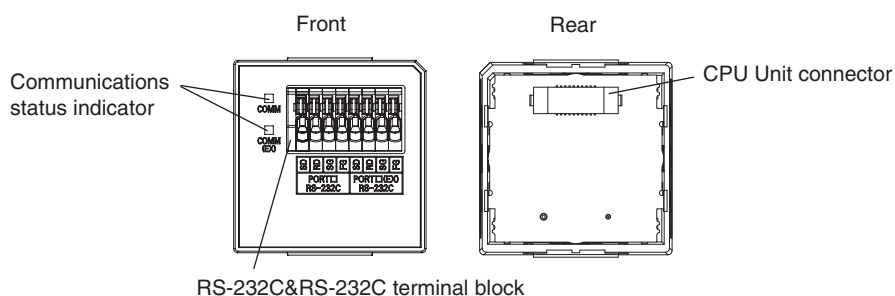

RS-232C&RS-232C terminal block

RS-232C&RS-232C Terminal Block

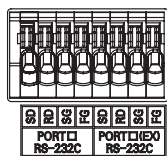

| Port | Pin | Abbr. | Signal Name | Signal direction |
|------------|-----|---------|---------------|------------------|
| PORT□ | 1 | SD(TXD) | Send data | Output |
| | 2 | RD(RXD) | Receive data | Input |
| | 3 | SG(0V) | Signal ground | --- |
| | 4 | FG | Frame ground | --- |
| PORT□ (EX) | 5 | SD(TXD) | Send data | Output |
| | 6 | RD(RXD) | Receive data | Input |
| | 7 | SG(0V) | Signal ground | --- |
| | 8 | FG | Frame ground | --- |

Note: 1. CP2W-CIFD1 can only be mounted on option slot 1.
 PORT□ is supported by serial port 1 and PORT□ (EX) is supported by serial port 1(EX).

CP2W-CIFD2 RS-232C&RS-485 Option Board

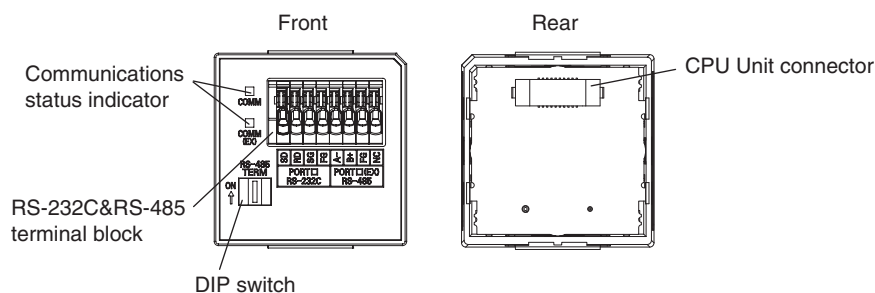

DIP switch

RS-232C&RS-485 Terminal Block

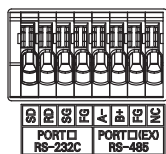

| Port | Pin | Abbr. | Signal Name | Signal direction |
|------------|-----|---------|---------------------|------------------|
| PORT□ | 1 | SD(TXD) | Send data | Output |
| | 2 | RD(RXD) | Receive data | Input |
| | 3 | SG(0V) | Signal ground | --- |
| | 4 | FG | Frame ground | --- |
| PORT□ (EX) | 5 | A- | Send/Receive data - | Output |
| | 6 | B+ | Send/Receive data + | Input |
| | 7 | FG | Frame ground | --- |
| | 8 | NC | NC | --- |

Note: CP2W-CIFD2 can only be mounted on option slot 1.
 PORT□ is supported by serial port 1 and PORT□ (EX) is supported by serial port 1(EX).

DIP switch for terminating resistance settings

| Setting | | | |
|---------|-----|----------------|--|
| | ON | ON (both ends) | Terminating resistance selection Resistance value: 220Ω typical |
| | OFF | OFF | |

CP2W-CIFD3 RS-485&RS-485 Option Board

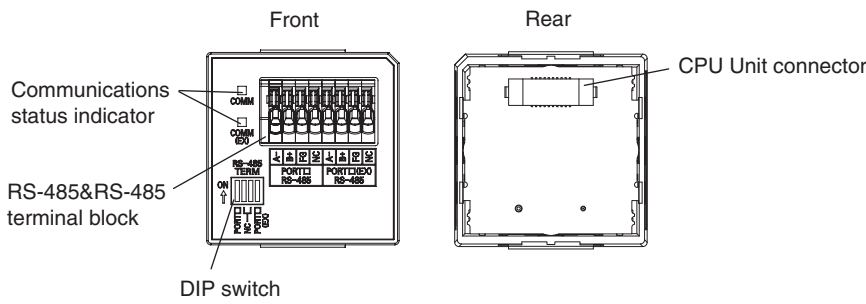

RS-485&RS-485 Terminal Block

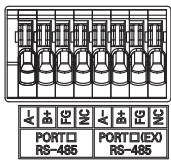

| Port | Pin | Abbr. | Signal Name | Signal direction |
|------------|-----|-------|---------------------|------------------|
| PORT□ | 1 | A- | Send/Receive data - | Output |
| | 2 | B+ | Send/Receive data + | Input |
| | 3 | FG | Frame ground | --- |
| | 4 | NC | NC | --- |
| PORT□ (EX) | 5 | A- | Send/Receive data - | Output |
| | 6 | B+ | Send/Receive data + | Input |
| | 7 | FG | Frame ground | --- |
| | 8 | NC | NC | --- |

Note: 1. CP2W-CIFD3 can only be mounted on option slot 1.
 PORT□ is supported by serial port 1 and PORT□ (EX) is supported by serial port 1(EX).

DIP switch for terminating resistance settings

| Pin | Setting | | | |
|-----|---------|-----|----------------|--|
| | 1 | ON | ON (both ends) | Terminating resistance selection Resistance value: 220Ω typical |
| | | OFF | OFF | |
| | 2 | --- | --- | Not used. |
| | 3 | --- | --- | Not used. |
| | 4 | ON | ON (both ends) | Terminating resistance selection Resistance value: 220Ω typical |
| | | OFF | OFF | |

Analog Option Board

N□□-type CPU Units

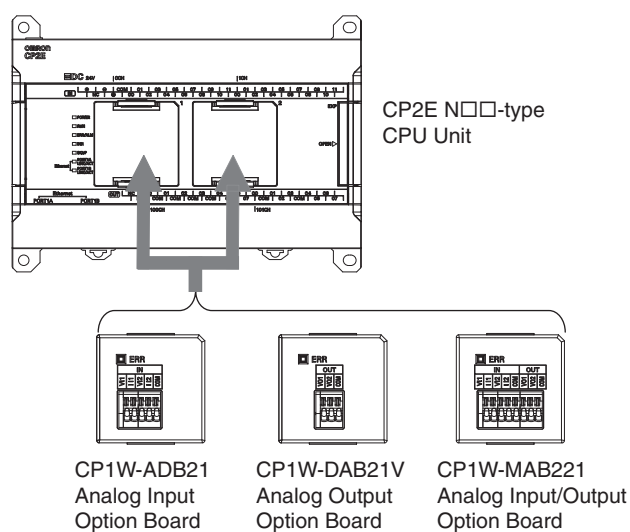

Note: 1. Maximum one Analog Option Board can be mounted on an N□□-type CPU Unit.
If two Analog Option Boards are mounted, an option board error will occur and both Analog Option Boards do not work.

Analog Option Board

Analog option board units are non-isolated analog units which allow you to easily realize analog input/output function for CP2E N□□-type CPU Unit.

| Analog Option Board | | Voltage Input 0V~10V (Resolution: 1/4000) | Current Input 0mA~20mA (Resolution: 1/2000) | Voltage Output 0V~10V (Resolution: 1/4000) |
|----------------------------|-------------|---|---|--|
| Analog I/O Option Board | CP1W-MAB221 | 2CH | | 2CH |
| Analog Input Option Board | CP1W-ADB21 | 2CH | | --- |
| Analog Output Option Board | CP1W-DAB21V | --- | | 2CH |

**Specifications of Analog Option Board
CP1W-ADB21**

| Item | Specifications | |
|--------------------------|--|---------------------|
| | Voltage Input | Current Input |
| Input signal range | 0 to 10 V | 0 to 20 mA |
| Max. rated input | 0 to 15 V | 0 to 30 mA |
| External input impedance | 200 kΩ min. | Approx. 250 Ω |
| Resolution | 1/4000 (full scale) | 1/2000 (full scale) |
| Overall accuracy | 25°C | ±0.5% (full scale) |
| | 0 to 60°C | ±1.0% (full scale) |
| | -20 to 0°C | ±1.3% (full scale) |
| A/D conversion data | 0000 to 0FA0 Hex | 0000 to 07D0 Hex |
| Averaging function | None | |
| Isolation method | No isolation between analog I/O terminals and internal circuits. | |
| Current consumption | 5 VDC: 20 mA max. | |

CP1W-DAB21V

| Item | Specifications | |
|---|--|--------------------|
| | Voltage Output | Current Output |
| Output signal range | 0 to 10 V | --- |
| External output allowable load resistance | 2 kΩ min. | --- |
| External output impedance | 0.5 Ω max. | --- |
| Resolution | 1/4000 (full scale) | --- |
| Overall accuracy | 25°C | ±0.5% (full scale) |
| | 0 to 60°C | ±1.0% (full scale) |
| | -20 to 0°C | ±1.3% (full scale) |
| Set data (D/A conversion) | 0000 to 0FA0 Hex | --- |
| Isolation method | No isolation between analog I/O terminals and internal circuits. | |
| Current consumption | 5 VDC: 60 mA max. | |

CP1W-MAB221

| Item | Specifications | | |
|---------------------------|--|---------------------|--------------------|
| | Voltage I/O | Current I/O | |
| Analog Input Section | Input signal range | 0 to 10 V | |
| | Max. rated input | 0 to 15 V | |
| | External input impedance | 200 kΩ min. | |
| | Resolution | 1/4000 (full scale) | |
| | Overall accuracy | 25°C | ±0.5% (full scale) |
| | | 0 to 60°C | ±1.0% (full scale) |
| | | -20 to 0°C | ±1.3% (full scale) |
| A/D conversion data | 0000 to 0FA0 Hex | | |
| Averaging function | None | | |
| Analog Output Section | Output signal range | 0 to 10 VDC | |
| | External output allowable load resistance | 2 kΩ min. | |
| | External output impedance | 0.5 Ω max. | |
| | Resolution | 1/4000 (full scale) | |
| | Overall accuracy | 25°C | ±0.5% (full scale) |
| | | 0 to 60°C | ±1.0% (full scale) |
| | | -20 to 0°C | ±1.3% (full scale) |
| Set data (D/A conversion) | 0000 to 0FA0 Hex | | |
| Isolation method | No isolation between analog I/O terminals and internal circuits. | | |
| Current consumption | 5 VDC: 80 mA max. | | |

Analog Option Board Refresh Time (Typical values)

| Analog Option Board | Cycle time (ms) | | |
|---------------------|-----------------|--------|--------|
| | 1 ms | 10 ms | 20 ms |
| CP1W-ADB21 | 16~40 | 20~60 | 20~100 |
| CP1W-DAB21V | 9~37 | 26~58 | 46~86 |
| CP1W-MAB221(AD) | 14~62 | 18~109 | 20~160 |
| CP1W-MAB221(DA) | 9~53 | 26~102 | 46~150 |

Specifications of Expansion I/O Units and Expansion Units

Expandable CPU Units

- Expansion I/O Units and Expansion Units cannot be connected to E14/20 or N14/20 CPU Units.
- A total of up to three Expansion I/O Units and Expansion Units can be connected to an E30/40/60, S30/40/60 or N30/40/60 CPU Unit.

CP2E-E14/20 or N14/20 CPU Unit

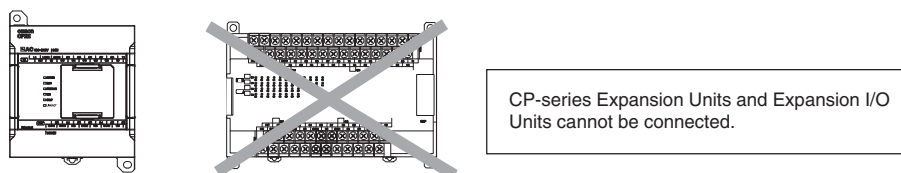

CP2E-E30/40/60, S30/40/60 or N30/40/60 CPU Unit

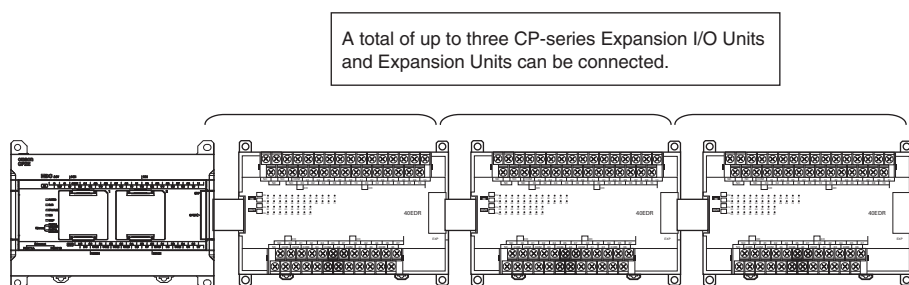

Connection Methods

Connection cables for the Expansion I/O Units and Expansion Units are used to connect the Units. The length can be extended by using a CP1W-CN811 I/O Connecting Cable (length: 800 mm).

Maximum Number of I/O Points for an Expansion I/O Unit or Expansion Unit

| CPU Unit | Built-in I/O on CPU Unit | | | Total number of Expansion I/O Units and Expansion Units that can be connected | Number of inputs: 24 Number of outputs: 16 Total number of I/O points when three CP1W-40ED□ Expansion I/O Units are connected | | |
|--------------|--------------------------|------------------|-------------------|---|---|------------------|-------------------|
| | Total | Number of inputs | Number of outputs | | Total | Number of inputs | Number of outputs |
| CP2E-□14D□-□ | 14 | 8 | 6 | Not possible. 3 Units maximum | 14 | 8 | 6 |
| CP2E-□20D□-□ | 20 | 12 | 8 | | 20 | 12 | 8 |
| CP2E-□30D□-□ | 30 | 18 | 12 | | 150 | 90 | 60 |
| CP2E-□40D□-□ | 40 | 24 | 16 | | 160 | 96 | 64 |
| CP2E-□60D□-□ | 60 | 36 | 24 | | 180 | 108 | 72 |

Specifications of Expansion I/O Units

Input Specifications (CP1W-8ED/20EDR1/20EDT/20EDT1/40EDR/40EDT/40EDT1)

| Item | Specification |
|-----------------------|--------------------------|
| Input voltage | 24 VDC, +10% / -15% |
| Input impedance | 4.7 kΩ |
| Input current | 5 mA typical |
| ON voltage / current | 14.4 VDC min. / 3mA min. |
| OFF voltage / current | 5.0 VDC max. / 1mA max. |
| ON response time | 1 ms max. *1 |
| OFF response time | 1 ms max. *1 |

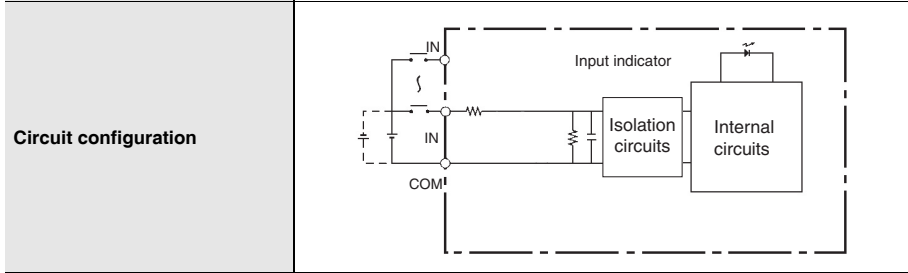

Note: 1. Do not apply voltage in excess of the rated voltage to the input terminal.

*1. The response time is the delay caused by hardware. The delay set in the PLC Setup (0 to 32 ms, default: 8 ms) must be added to this value. For the CP1W-40EDR/EDT/EDT1, a fixed value of 16 ms must be added.

Output Specifications

Relay Outputs (CP1W-8ER/16ER/20EDR1/32ER/40EDR)

| Item | Specification | |
|-------------------------|--|--|
| Max. switching capacity | 2 A, 250 VAC (cosφ = 1), 2 A, 24 VDC (4 A/common) | |
| Min. switching capacity | 10 mA, 5 VDC | |
| Service life of relay | Electrical Resistive load | 150,000 operations (24 VDC) |
| | Inductive load | 100,000 operations (240 VAC, cosφ = 0.4) |
| | Mechanical | 20,000,000 operations |
| ON response time | 15 ms max. | |
| OFF response time | 15 ms max. | |

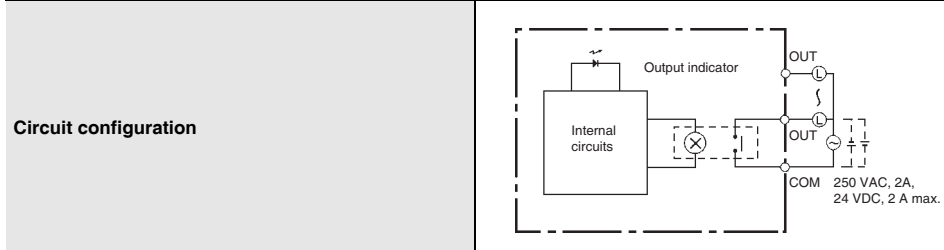

Note: 1. Estimating the Service Life of Relays

The service life of output contacts is as shown in the following diagram.

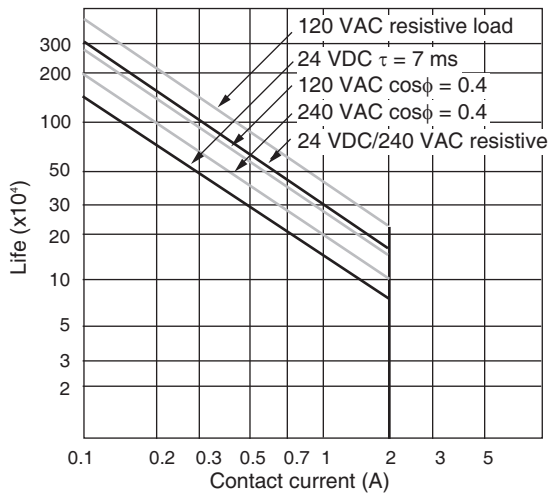

Switching frequency: 1,800 operations/hour

2. Restrictions of CP1W-16ER/32ER

Limit the output load current to satisfy the following derating curve.

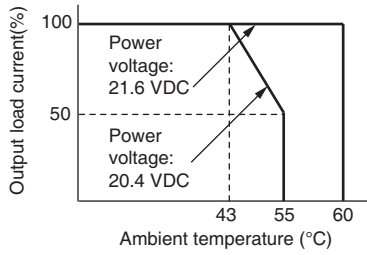

3. CP1W-32ER's maximum number of simultaneously ON output points is 24 (75%).
Relation between Number of ON Outputs and Ambient Temperature (CP1W-32ER)

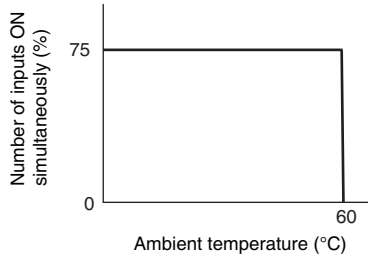

4. According to the ambient temperature, there are restrictions on power supply voltage and output load current for the CPU Units connected with the Expansion I/O Units (CP1W-8ER/16ER/20EDR1/32ER/40EDR). Use the PLC in the range of the power supply voltage and output load current as show below.

- The ambient temperature is restricted for the DC power supply CPU Units.
Derating curve of the output load current for Expansion I/O Units (CP1W-8ER/16ER/20EDR1/32ER/40EDR).

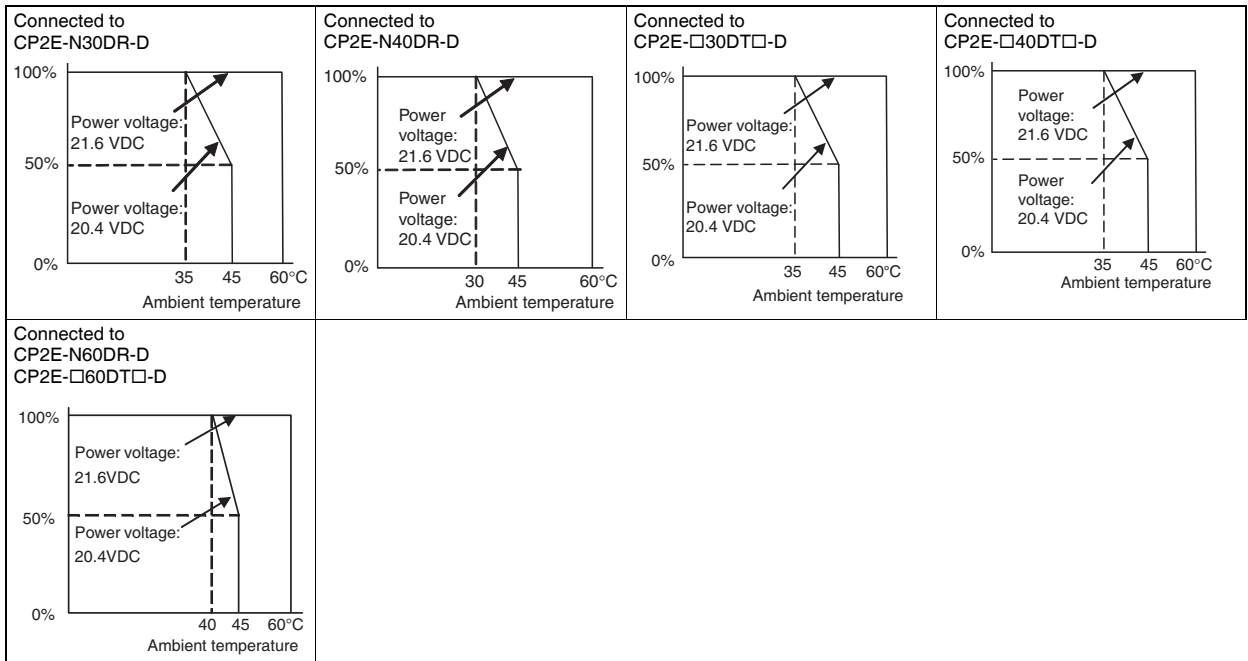

Transistor Outputs (Sinking or Sourcing)

| Item | Specification | | | | |
|--|---|---|---|---|---|
| | CP1W-40EDT CP1W-40EDT1 | CP1W-32ET CP1W-32ET1 | CP1W-20EDT CP1W-20EDT1 | CP1W-16ET CP1W-16ET1 | CP1W-8ET CP1W-8ET1 |
| Max. switching capacity *1 | 4.5 to 30 VDC 0.3 A/output 0.9 A/common 3.6 A/Unit | 4.5 to 30 VDC 0.3 A/output 0.9 A/common 7.2 A/Unit | 24 VDC +10%/-5% 0.3 A/output 0.9 A/common 1.8 A/Unit | 4.5 to 30 VDC 0.3 A/output 0.9 A/common 3.6 A/Unit | 4.5 to 30 VDC 0.3 A/output 0.9 A/common 1.8 A/Unit |
| Leakage current | 0.1 mA max. | 0.1 mA max. | 0.1 mA max. | 0.1 mA max. | 0.1 mA max. |
| Residual voltage | 1.5 V max. | 1.5 V max. | 1.5 V max. | 1.5 V max. | 1.5 V max. |
| ON response time | 0.1 ms max. | 0.1 ms max. | 0.1 ms. | 0.1 ms max. | 0.1 ms max. |
| OFF response time | 1 ms max. At 24 VDC +10%/-5%, 5 to 300 mA | 1 ms max. At 24 VDC +10%/-5%, 5 to 300 mA | 1 ms max. At 24 VDC +10%/-5%, 5 to 300 mA | 1 ms max. At 24 VDC +10%/-5%, 5 to 300 mA | 1 ms max. At 24 VDC +10%/-5%, 5 to 300 mA |
| Maximum number of simultaneously ON outputs | 16 points (100% load) | 24 points (100% load) | 8 points (100% load) | 16 points (100% load) | 8 points (100% load) |
| Fuse *2 | 1 fuse/common | | | | |

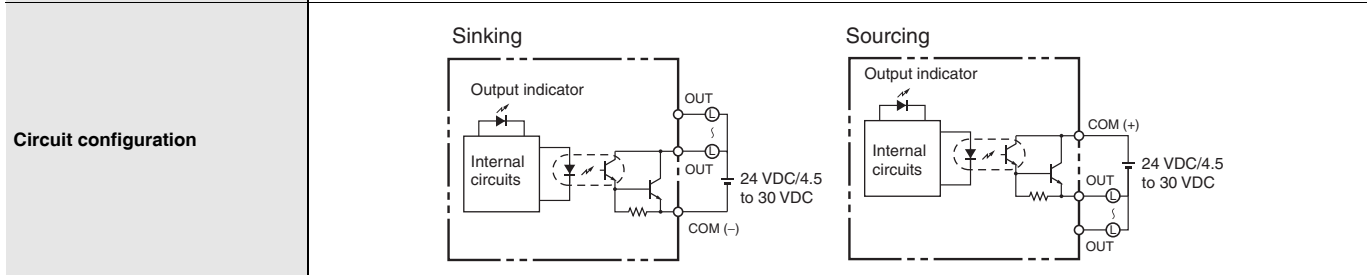

*1. If the ambient temperature is maintained below 50°C, up to 0.9 A/common can be used.

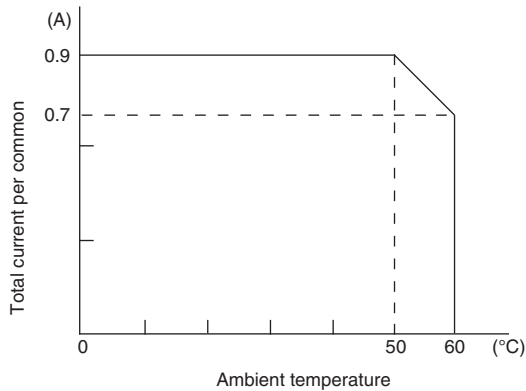

*2. The fuse cannot be replaced by the user. Replace the Unit if the fuse breaks due to an short-circuit or overcurrent.
Note: 1. Do not connect a load to an output terminal or apply a voltage in excess of the maximum switching capacity.

Specifications of Expansion Units

Analog Input Units

| Model | | CP1W-AD041 | | CP1W-AD042 | |
|---------------------------------|------------|--|--------------------------|--|--------------------------|
| Item | | Voltage input | Current input | Voltage input | Current input |
| Number of analog inputs | | 4 inputs (4 words allocated) | | | |
| Input signal range | | 0 to 5 V, 1 to 5 V, 0 to 10 V, or -10 to 10 V | 0 to 20 mA or 4 to 20 mA | 0 to 5 V, 1 to 5 V, 0 to 10 V, or -10 to 10 V | 0 to 20 mA or 4 to 20 mA |
| Max. rated input | | ±15 V | ±30 mA | ±15 V | ±30 mA |
| External input impedance | | 1 MΩ min. | Approx. 250 Ω | 1 MΩ min. | Approx. 250 Ω |
| Resolution | | 1/6000 (full scale) | | 1/12000 (full scale) | |
| Overall accuracy | 25°C | 0.3% full scale | 0.4% full scale | 0.2% full scale | 0.3% full scale |
| | 0 to 55°C | 0.6% full scale | 0.8% full scale | 0.5% full scale | 0.7% full scale |
| | 55 to 60°C | 0.7% full scale | 0.8% full scale | 0.5% full scale | 0.7% full scale |
| | -20 to 0°C | 0.8% full scale | 1% full scale | 0.7% full scale | 0.9% full scale |
| A/D conversion data | | 16-bit binary (4-digit hexadecimal) Full scale for -10 to 10 V: F448 to 0BB8 hex Full scale for other ranges: 0000 to 1770 hex | | 16-bit binary (4-digit hexadecimal) Full scale for -10 to 10 V: E890 to 1770 hex Full scale for other ranges: 0000 to 2EE0 hex | |
| Averaging function | | Supported (Set in output words n+1 and n+2.) | | | |
| Open-circuit detection function | | Supported | | | |
| Conversion time | | 2 ms/point (8 ms/all points) | | 1 ms/point (4 ms/all points) | |
| Isolation method | | Photocoupler isolation between analog input terminals and internal circuits. No isolation between analog I/O signals. | | | |
| Current consumption | | 5 VDC: 100 mA max.; 24 VDC: 90 mA max. | | 5 VDC: 100 mA max.; 24 VDC: 50 mA max. | |

Analog Output Units

| Model | | CP1W-DA021/CP1W-DA041 | | CP1W-DA042 | |
|---|------------|--|--------------------------|--|--------------------------|
| Item | | Voltage output | Current output | Voltage output | Current output |
| Number of analog outputs | | CP1W-DA021: 2 outputs (2 words allocated) CP1W-DA041: 4 outputs (4 words allocated) | | 4 outputs (4 words allocated) | |
| Output signal range | | 1 to 5 V, 0 to 10 V, or -10 to 10 V | 0 to 20 mA or 4 to 20 mA | 1 to 5 V, 0 to 10 V, or -10 to 10 V | 0 to 20 mA or 4 to 20 mA |
| External output allowable load resistance | | 2 kΩ min. | 350 Ω max. | 2 kΩ min. | 350 Ω max. |
| External output impedance | | 0.5 Ω max. | --- | 0.5 Ω max. | --- |
| Resolution | | 1/6000 (full scale) | | 1/12000 (full scale) | |
| Overall accuracy | 25°C | 0.4% full scale | | 0.3% full scale | |
| | 0 to 55°C | 0.8% full scale | | 0.7% full scale | |
| | -20 to 0°C | 1% full scale | | 0.9% full scale | |
| D/A conversion data | | 16-bit binary (4-digit hexadecimal) Full scale for -10 to 10 V: F448 to 0BB8 hex Full scale for other ranges: 0000 to 1770 hex | | 16-bit binary (4-digit hexadecimal) Full scale for -10 to 10 V: E890 to 1770 hex Full scale for other ranges: 0000 to 2EE0 hex | |
| Conversion time | | CP1W-DA021: 2 ms/point (4 ms/all points) CP1W-DA041: 2 ms/point (8 ms/all points) | | 1 ms/point (4 ms/all points) | |
| Isolation method | | Photocoupler isolation between analog output terminals and internal circuits. No isolation between analog I/O signals. | | | |
| Current consumption | | CP1W-DA021: 5 VDC: 40 mA max.; 24 VDC: 95 mA max. CP1W-DA041: 5 VDC: 80 mA max.; 24 VDC: 124 mA max. | | 5 VDC: 70 mA max.; 24 VDC: 160 mA max. | |

Analog I/O Units

| Model | | CP1W-MAD42/CP1W-MAD44 | | CP1W-MAD11 | | |
|---------------------------------|--|--|--|--|--------------------------|-----------------|
| Item | | Voltage I/O | Current I/O | Voltage I/O | Current I/O | |
| Analog Input Section | Number of inputs | 4 inputs (4 words allocated) | | 2 inputs (2 words allocated) | | |
| | Input signal range | 0 to 5 V, 1 to 5 V, 0 to 10 V, or -10 to 10 V | 0 to 20 mA or 4 to 20 mA | 0 to 5 V, 1 to 5 V, 0 to 10 V, or -10 to 10 V | 0 to 20 mA or 4 to 20 mA | |
| | Max. rated input | ±15 V | ±30 mA | ±15 V | ±30 mA | |
| | External input impedance | 1 MΩ min. | Approx. 250 Ω | 1 MΩ min. | Approx. 250 Ω | |
| | Resolution | 1/12000 (full scale) | | 1/6000 (full scale) | | |
| | Overall accuracy | 25°C | 0.2% full scale | 0.3% full scale | 0.3% full scale | 0.4% full scale |
| | | 0 to 55°C | 0.5% full scale | 0.7% full scale | 0.6% full scale | 0.8% full scale |
| | | -20 to 0°C | 0.7% full scale | 0.9% full scale | 0.8% full scale | 1% full scale |
| | A/D conversion data | 16-bit binary (4-digit hexadecimal) Full scale for -10 to 10 V: E890 to 1770 hex Full scale for other ranges: 0000 to 2EE0 hex | | 16-bit binary (4-digit hexadecimal) Full scale for -10 to 10 V: F448 to 0BB8 hex Full scale for other ranges: 0000 to 1770 hex | | |
| Averaging function | Supported | | Supported (Settable for individual inputs via DIP switch) | | | |
| Open-circuit detection function | Supported | | | | | |
| Analog Output Section | Number of outputs | CP1W-MAD42: 2 outputs (2 words allocated) CP1W-MAD44: 4 outputs (4 words allocated) | | 1 output (1 word allocated) | | |
| | Output signal range | 1 to 5 V, 0 to 10 V, or -10 to 10 V | 0 to 20 mA or 4 to 20 mA | 1 to 5 V, 0 to 10 V, or -10 to 10 V | 0 to 20 mA or 4 to 20 mA | |
| | Allowable external output load resistance | 2 kΩ min. | 350 Ω max. | 1 kΩ min. | 600 Ω max. | |
| | External output impedance | 0.5 Ω max. | --- | 0.5 Ω max. | --- | |
| | Resolution | 1/12000 (full scale) | | 1/6000 (full scale) | | |
| | Overall accuracy | 25°C | 0.3% full scale | 0.4% full scale | 0.4% full scale | 0.8% full scale |
| | | 0 to 55°C | 0.7% full scale | 0.8% full scale | 0.8% full scale | 1% full scale |
| | | -20 to 0°C | 0.9% full scale | 0.9% full scale | 1% full scale | 1% full scale |
| Set data (D/A conversion) | 16-bit binary (4-digit hexadecimal) Full scale for -10 to 10 V: E890 to 1770 hex Full scale for other ranges: 0000 to 2EE0 hex | | 16-bit binary (4-digit hexadecimal) Full scale for -10 to 10 V: F448 to 0BB8 hex Full scale for other ranges: 0000 to 1770 hex | | | |
| Conversion time | CP1W-MAD42: 1 ms/point (6 ms/all points) CP1W-MAD44: 1 ms/point (8 ms/all points) | | 2 ms/point (6 ms/all points) | | | |
| Isolation method | Photocoupler isolation between analog I/O terminals and internal circuits. No isolation between analog I/O signals. | | | | | |
| Current consumption | CP1W-MAD42: 5 VDC: 120 mA max., 24 VDC: 120 mA max. CP1W-MAD44: 5 VDC: 120 mA max., 24 VDC: 170 mA max. | | 5 VDC: 83 mA max., 24 VDC: 110 mA max. | | | |

Temperature Sensors Units

| Item | | CP1W-TS001 | CP1W-TS002 | CP1W-TS101 | CP1W-TS102 |
|----------------------------|---|--|------------|---|------------|
| Temperature sensors | | Thermocouples | | Platinum resistance thermometer | |
| | | Switchable between K and J, but same type must be used for all inputs. | | Switchable between Pt100 and JPt100, but same type must be used for all inputs. | |
| Number of inputs | | 2 | 4 | 2 | 4 |
| Allocated input words | | 2 | 4 | 2 | 4 |
| Accuracy | 25°C | (The larger of ±0.5% of converted value or ±2°C) ±1 digit max. | | (The larger of ±0.5% of converted value or ±1°C) ±1 digit max. | |
| | 0 to 60°C | (The larger of ±1% of converted value or ±4°C) ±1 digit max. | | (The larger of ±1% of converted value or ±2°C) ±1 digit max. | |
| | -20 to 0°C | (The larger of ±1.3% of converted value or ±5°C) ±1 digit max. *1 | | (The larger of ±1.3% of converted value or ±3°C) ±1 digit max. | |
| Conversion time | 250 ms for 2 or 4 input points | | | | |
| Converted temperature data | 16-bit binary data (4-digit hexadecimal) | | | | |
| Isolation | Photocouplers between all temperature input signals | | | | |
| Current consumption | 5 VDC: 40 mA max., 24 VDC: 59 mA max. | | | 5 VDC: 54 mA max., 24 VDC: 73 mA max. | |

*1. Accuracy for a K-type sensor at -100°C or less is ±4°C ±1 digit max.

The rotary switch is used to set the temperature range.

| Setting | CP1W-TS001/TS002 | | | CP1W-TS101/TS102 | | | |
|--|------------------|----------------|---------------|------------------|------------|-----------------|-------------------|
| | Input type | Range (°C) | Range (°F) | Input type | Range (°C) | Range (°F) | |
|  | 0 | K | -200 to 1,300 | -300 to 2,300 | Pt100 | -200.0 to 650.0 | -300.0 to 1,200.0 |
| | 1 | | 0.0 to 500.0 | 0.0 to 900.0 | JPt100 | -200.0 to 650.0 | -300.0 to 1,200.0 |
| | 2 | J | -100 to 850 | -100 to 1,500 | --- | Cannot be set. | |
| | 3 | | 0.0 to 400.0 | 0.0 to 750.0 | --- | | |
| 4 to F | --- | Cannot be set. | | --- | | | |

Main Specifications

| Item | | CP1W-TS003 | |
|---------------------------------|-------------|--|--|
| Temperature sensors | | Thermocouples or analog input *1 Switchable between K and J, but same type must be used for all inputs. | |
| Number of inputs | | 4 | |
| Allocated input words | | 4 | |
| Max. number of Units | | 3 | |
| Accuracy | 25 °C | Thermocouple inputs | (The larger of $\pm 0.5\%$ of converted value or $\pm 2^\circ\text{C}$) ± 1 digit max. *2 |
| | | Analog voltage inputs | 0.5% full scale |
| | | Analog current inputs | 0.6% full scale |
| | 0 to 60 °C | Thermocouple inputs | (The larger of $\pm 1\%$ of converted value or $\pm 4^\circ\text{C}$) ± 1 digit max. *3 |
| | | Analog voltage inputs | 1.0% full scale |
| | | Analog current inputs | 1.2% full scale |
| | -20 to 0 °C | Thermocouple inputs | (The larger of $\pm 1.3\%$ of converted value or $\pm 5^\circ\text{C}$) ± 1 digit max. *3 |
| | | Analog voltage inputs | 1.2% full scale |
| | | Analog current inputs | 1.5% full scale |
| Input signal range | | Thermocouple inputs | K: -200.0 to 1300.0°C or -300.0 to 2300.0°F J: -100.0 to 850.0°C or -100.0 to 1500.0°F |
| | | Analog voltage inputs | 0 to 10V/1 to 5V |
| | | Analog current inputs | 4 to 20mA |
| Resolution | | Thermocouple inputs | 0.1°C or 0.1°F |
| | | Analog inputs | 1/12000 (full scale) |
| Max. rated input | | Analog voltage inputs | $\pm 15\text{V}$ |
| | | Analog current inputs | $\pm 30\text{mA}$ |
| External input impedance | | Analog voltage inputs | 1M Ω min. |
| | | Analog current inputs | 250 Ω |
| Open-circuit detection function | | Supported | |
| Averaging function | | Unsupported | |
| Conversion time | | 250 ms for 4 input points | |
| Converted temperature data | | 16-bit binary data (4-digit hexadecimal) 2-decimal-place mode is not supported | |
| Converted AD data | | 16-bit binary data (4-digit hexadecimal) | |
| Isolation | | Photocouplers between any two input signals | |
| Current consumption | | 5 VDC: 70 mA max., 24 VDC: 30 mA max. | |

*1. Only last two channels can be used as analog input.

*2. Accuracy for a K-type sensor at -100°C or less is $\pm 4^\circ\text{C} \pm 1$ digit max.

*3. Accuracy for a K-type sensor at -100°C or less is $\pm 10^\circ\text{C} \pm 1$ digit max.

DIP Switch Settings

With the Temperature Sensor Unit's DIP switch, set the input type (temperature or analog input), the input thermocouple type (K or J) and the temperature unit ($^\circ\text{C}$ or $^\circ\text{F}$).

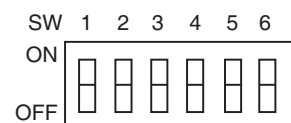

| SW | Setting | |
|----|---|----------------------|
| 1 | Thermocouple type of temperature sensor | ON J |
| | | OFF K |
| 2 | Temperature unit | ON $^\circ\text{F}$ |
| | | OFF $^\circ\text{C}$ |
| 3 | NC | |
| 4 | Input type selection for the third input (Input 2) | ON Analog input |
| | | OFF Thermocouple |
| 5 | Input type selection for the fourth input (Input 3) | ON Analog input |
| | | OFF Thermocouple |
| 6 | Analog input signal range | ON 1 to 5V/4 to 20mA |
| | | OFF 0 to 10V |

| Temperature input | | | Analog input | |
|-------------------|----------------------------|----------------------------|--------------|------------------|
| Input type | Range ($^\circ\text{C}$) | Range ($^\circ\text{F}$) | Input type | Range |
| K | -200.0 to 1300.0 | -300.0 to 2300.0 | Voltage | 0 to 10V/1 to 5V |
| J | -100.0 to 850.0 | -100.0 to 1500.0 | Current | 4 to 20mA |

Main Specifications

| Item | | CP1W-TS004 |
|----------------------------|------------|---|
| Temperature sensors | | Thermocouples Switchable between K and J, but same type must be used for all inputs. |
| Number of inputs | | 12 |
| Allocated input words | | 2 |
| Allocated output words | | 1 |
| Accuracy | 25°C | (The larger of ±0.5% of converted value or ±2°C) ±1 digit max. *1 |
| | 0 to 60°C | (The larger of ±1% of converted value or ±4°C) ±1 digit max. *2 |
| | -20 to 0°C | (The larger of ±1.3% of converted value or ±5°C) ±1 digit max. *2 |
| Conversion time | | 500 ms for 12 input points |
| Converted temperature data | | 16-bit binary data (4-digit hexadecimal) 2-decimal-place mode is not supported |
| Isolation | | Photocouplers between any two input signals |
| Current consumption | | 5 VDC: 80 mA max., 24 VDC: 50 mA max. |

* 1 Accuracy for a K-type sensor at -100°C or less is ±4°C ±1 digit max.

* 2 Accuracy for a K-type sensor at -100°C or less is ±10°C ±1 digit max.

DIP Switch Settings

With the Temperature Sensor Unit's DIP switch, set the temperature unit and the temperature input range.

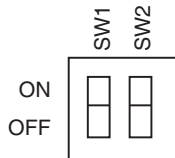

| SW | Setting | ON | OFF |
|----|------------------|----|-----|
| 1 | Input type | J | K |
| | | K | J |
| 2 | Temperature unit | °F | °C |
| | | °C | °F |

| Temperature input | | |
|-------------------|------------------|------------------|
| Input type | Range (°C) | Range (°F) |
| K | -200.0 to 1300.0 | -300.0 to 2300.0 |
| J | -100.0 to 850.0 | -100.0 to 1500.0 |

Dimensions

CPU Units with 14 or 20 I/O Points

CP2E-N14/20D□-□

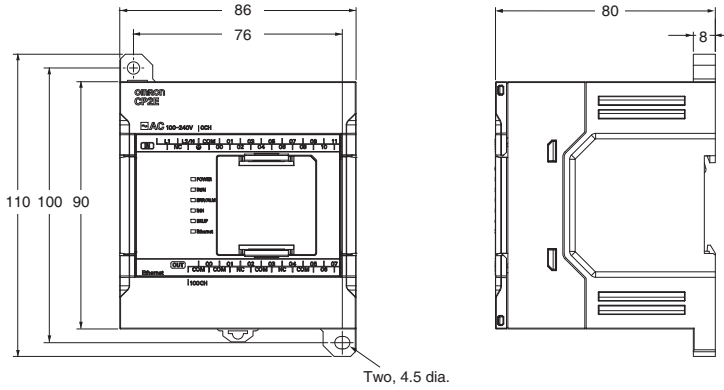

CP2E-E14/20D□-□

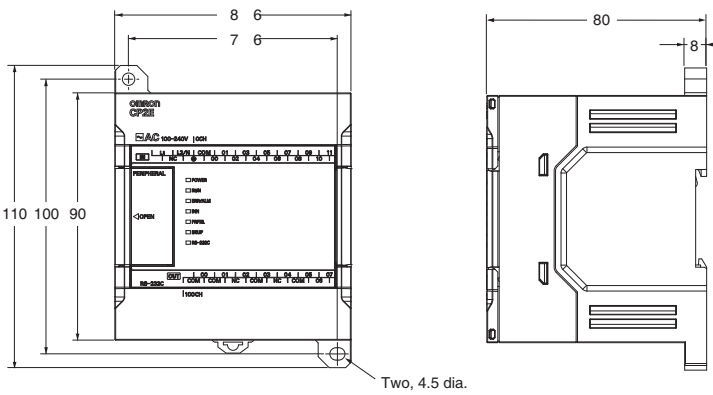

CPU Units with 30 I/O Points

CP2E-N30D□-□

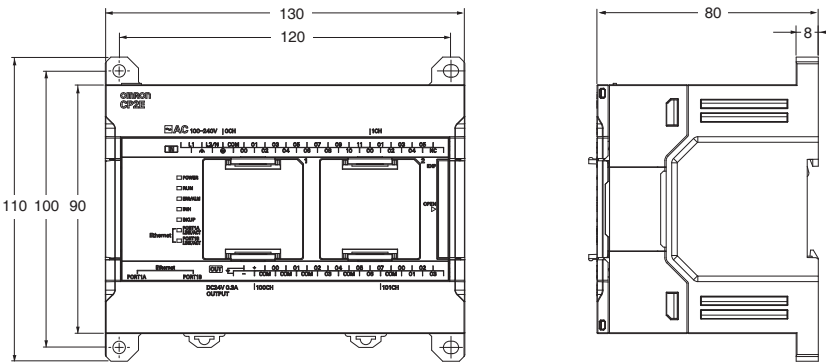

CP2E-E30D□-□, CP2E-S30D□-□

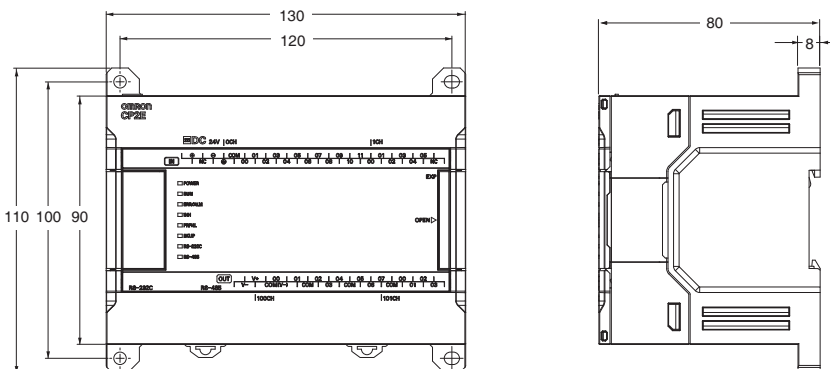

CP2E

CPU Units with 40 I/O Points

CP2E-N40D□-□

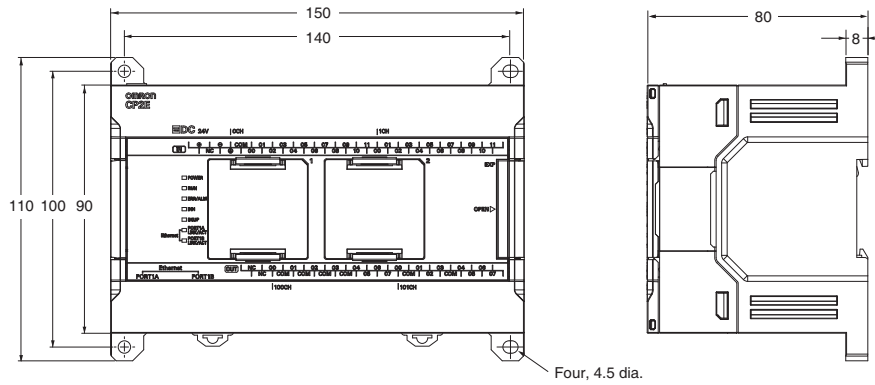

CP2E-E40D□-□, CP2E-S40D□-□

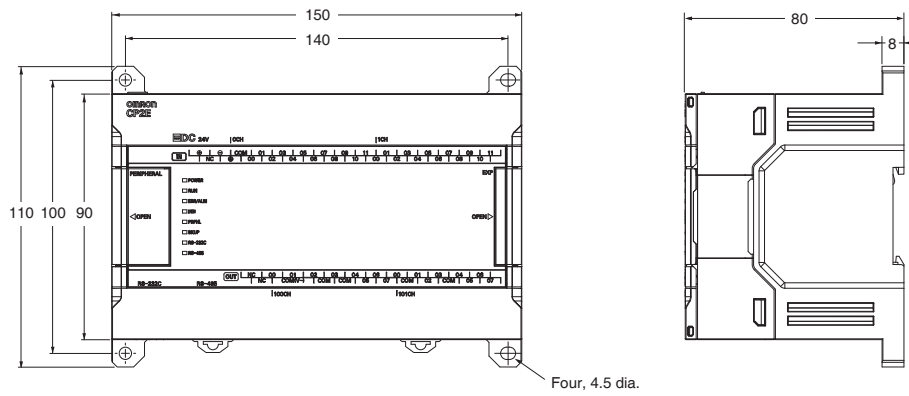

CPU Units with 60 I/O Points

CP2E-N60D□-□

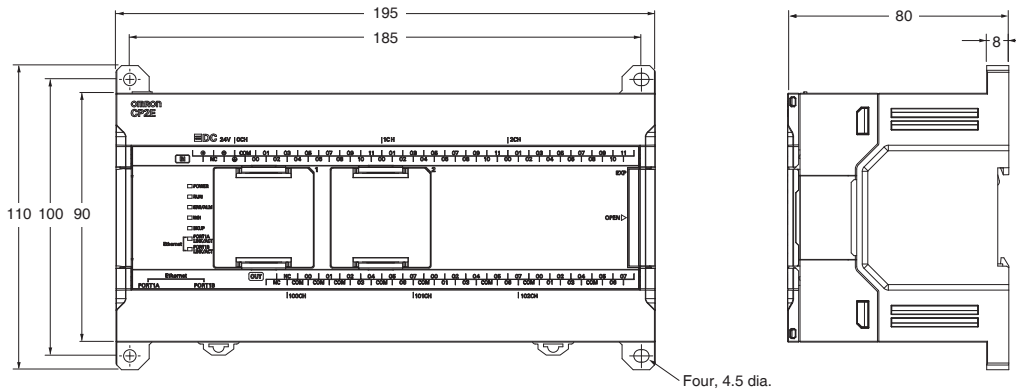

CP2E-E60D□-□, CP2E-S60D□-□

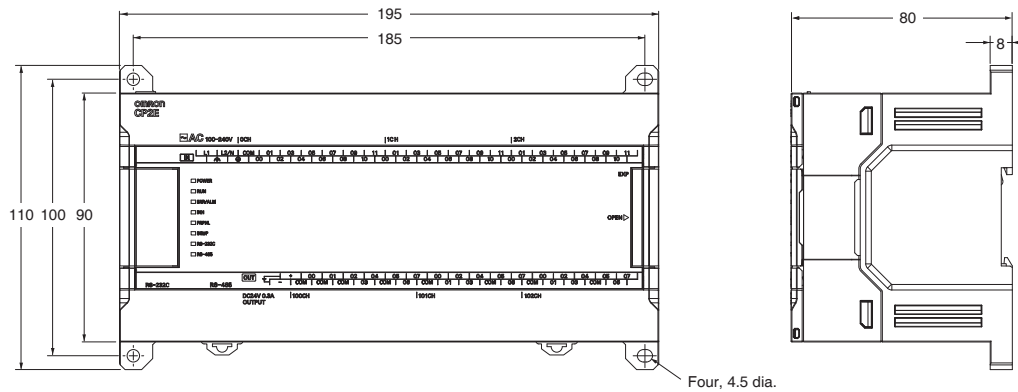

Expansion I/O Units and Expansion Units

CP1W-8E□□

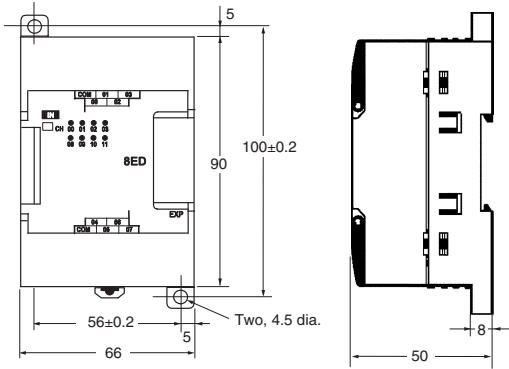

CP1W-20ED□/CP1W-16E□□/CP1W-AD04□/CP1W-DA021/CP1W-DA04□/CP1W-MAD□□/
CP1W-TS□□1/□□2/□□3

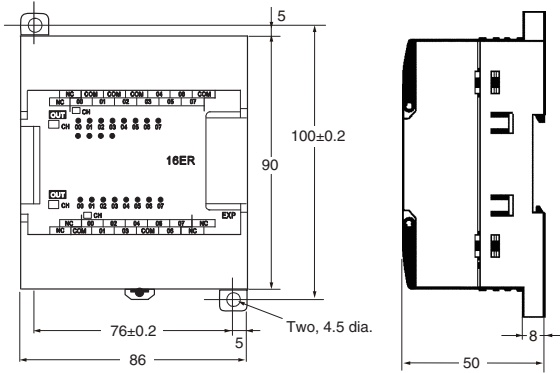

CP1W-40ED□/CP1W-32E□□/CP1W-TS004

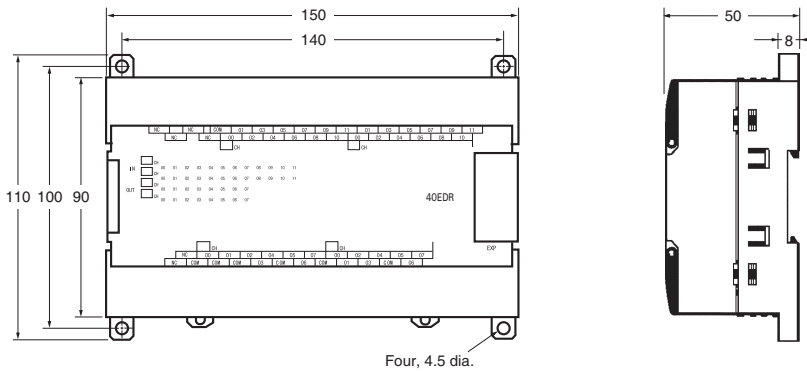

Comparison of specifications of CP2E and CP1E

| Specifications | CP2E | | | CP1E | | | |
|--|--|---|--|--|---|--|---|
| | CP2E-N□□ | CP2E-S□□ | CP2E-E□□ | CP1E-N□□ | CP1E-N□□S□ | CP1E-E□□ CP1E-E□□S | CP1E-NA20 |
| Number of built-in I/O points | 14/20/30/40/60 | 30/40/60 | 14/20/30/40/60 | 14/20/30/40/60 | 30/40/60 | 10/14/20/30/40/60 | 20 |
| Total number of Expansion units | 14/20 points None 30/40/60 points 3 units | | | 14/20 points None 30/40/60 points 3 units | | | |
| Lineup Output/power supply type | <ul style="list-style-type: none"> Relay/AC Relay/DC Transistor (sinking)/AC Transistor (sinking)/DC Transistor (sourcing)/DC | <ul style="list-style-type: none"> Relay/AC Transistor (sinking)/DC Transistor (sourcing)/DC | <ul style="list-style-type: none"> Relay/AC | <ul style="list-style-type: none"> Relay/AC Relay/DC Transistor (sinking)/AC Transistor (sourcing)/AC Transistor (sinking)/DC Transistor (sourcing)/DC | <ul style="list-style-type: none"> Relay/AC Transistor (sinking)/DC Transistor (sourcing)/DC | <ul style="list-style-type: none"> Relay/AC Relay/DC Transistor (sinking)/AC Transistor (sourcing)/AC Transistor (sinking)/DC Transistor (sourcing)/DC | <ul style="list-style-type: none"> Relay/AC Transistor (sinking)/DC Transistor (sourcing)/DC |
| Program capacity | 10K steps | 8K steps | 4K steps | 8K steps | 8K steps | 2K steps | 8K steps |
| FB capacity | 10K steps | 8K steps | 4K steps | None | | | |
| Function block steps | Yes Languages usable in function block definitions: Ladder diagrams, structured text (ST) | | | None | | | |
| Overhead processing time | 0.2 ms | 0.15 ms | 0.1 ms | 0.4 ms | | | |
| Instruction execution times | LD 0.23 μs MOV 1.76 μs | | | LD 1.19 μs MOV 7.9 μs | | | |
| Data memory capacity | 16K words | 8K words | 4K words | 8K words | 8K words | 2K words | 8K words |
| IO Memory backup | Built-in non-volatile memory (Batteryless backup) | | | Built-in SRAM (Battery backup) | | | |
| Pulse outputs | N14/20: 2 outputs 100 kHz N30/40/60: 4 outputs 100 kHz (Linear interpolation possible) | 2 outputs 100 kHz | None | 2 outputs 100kHz | 2 outputs 100kHz | None | 2 outputs 100kHz |
| High-speed counters (Differential Phase) | N14/20: 2 counters (50 kHz, 5 kHz) N30/40/60: 2 counters (50 kHz x2) | 2 counters (50 kHz, 5 kHz) | | 2 counters (50 kHz, 5 kHz) | | 2 counters (5 kHz x2) | 2 counters (50 kHz, 5 kHz) |
| Quick-response Interrupt inputs | 8 inputs (6 inputs only for 14 points) | 6 inputs | | 6 inputs (4 inputs only for 10 points) | | | |
| Ethernet port | Included N14/20: 1 port N30/40/60: 2 port | None | None | None N30/40/60 only: 1 port (CP1W-CIF41 use) | None | None | 1 port (CP1W-CIF41 use) |
| USB port | None | Included | Included | Included | | | |
| Serial port | N14/20: Max 2 port (Option boards use) N30/40/60: Max 3 port (Option boards use) | 2 port RS-232C RS-485 | 1 port RS-232C | N14/20: 1 port RS-232C N30/40/60: Max 2 port RS-232C Option board | 1 port RS-232C N30/40/60 S1 Type only: Max 2 port RS-232C RS-485 | None | Max 2 port RS-232C Option board |
| Serial communication protocols | Host Link 1: N NT Link (1: N) No-protocol mode Serial PLC Link (master, slave) Modbus-RTU easy master Modbus-RTU Slave | | | Host Link 1: N NT Link (1: N) No-protocol mode Serial PLC Link (master, slave) Modbus-RTU easy master | | | |
| Option Boards | N14/20: 1 unit N30/40/60: 2 units | None | None | N14/20: None N30/40/60: 1 unit | None | None | 1 unit |
| Clock function | Yes | Yes | None | Yes | Yes | None | Yes |
| Corresponding battery | CP2W-BAT02 (for clock function) | | None | CP1W-BAT01 (for clock function, IO memory backup) | | None | CP1W-BAT01 |
| Built-in analog | None | | | None | | | Analog input 2channels Analog output 1channel |
| Analog adjusters | None | None | None | Yes | None | E□□: Yes E□□S: None | Yes |
| Ambient operating temperature | -20 to 60 °C | | | 0 to 55 °C | | | |

Easy to convert CP1E code into CP2E code

Uploaded CP1E code can be converted into CP2E code with just one click.



Cx-One Ver 4.51 or higher
Cp-programmer Ver 9.72 or higher

Examples of replacement of CP1E with CP2E

| CP1E-E□□/E□□S | CP2E-E□□ |
|-----------------------|------------------------|
| CP1E-E10D□-□ | CP2E-E14DR-A or others |
| CP1E-E14SDR-A/E14DR-A | CP2E-E14DR-A |
| CP1E-E20SDR-A/E20DR-A | CP2E-E20DR-A |
| CP1E-E30SDR-A/E30DR-A | CP2E-E30DR-A |
| CP1E-E40SDR-A/E40DR-A | CP2E-E40DR-A |
| CP1E-E60SDR-A | CP2E-E60DR-A |

| CP1E-N□□S | CP2E-S□□ |
|-------------------------|--------------|
| CP1E-N30SD□-□/N30S1D□-□ | CP2E-S30D□-□ |
| CP1E-N40SD□-□/N40S1D□-□ | CP2E-S40D□-□ |
| CP1E-N60SD□-□/N60S1D□-□ | CP2E-S60D□-□ |

| CP1E-N□□ | CP2E-S□□ *1 | CP2E-N□□ *1 |
|--------------|--------------|--------------------------------------|
| CP1E-N14D□-□ | - | CP2E-N14D□-□ |
| CP1E-N20D□-□ | - | CP2E-N20D□-□ |
| CP1E-N30D□-□ | CP2E-S30D□-□ | CP2E-N30D□-□ |
| CP1E-N40D□-□ | CP2E-S40D□-□ | CP2E-N40D□-□ |
| CP1E-N60D□-□ | CP2E-S60D□-□ | CP2E-N60D□-□ |
| CP1E-NA20□-□ | - | CP2E-N30D□-□ + CP1W-MAB221 or others |

*1. When the AC powered N30/40/60 CPU Unit with relay outputs, or the DC powered N30/40/60 CPU Unit with transistor outputs is used without an option board or with the CP1W-CIF11 Option Board, it is recommended to replace with the CP2E-S□□.

When any of the other CPU units is used with an option board, it is recommended to replace with the CP2E-N□□.
For details, refer to the *Replacement Guide from CP1E to CP2E* (Cat. No. P150).

CP2E

Related Manuals

| Manual name | Cat. No. | Model numbers | Application | Contents |
|--|----------|---|---|--|
| SYSMAC CP Series CP2E CPU Unit Hardware User's Manual | W613 | CP2E-E□□D□-□ CP2E-S□□D□-□ CP2E-N□□D□-□ | To learn the hardware specifications of the CP2E PLCs | Describes the following information for CP2E PLCs. <ul style="list-style-type: none"> • Overview and features • Basic system configuration • Part names and functions • Installation and settings • Troubleshooting |
| SYSMAC CP Series CP2E CPU Unit Software User's Manual | W614 | CP2E-E□□D□-□ CP2E-S□□D□-□ CP2E-N□□D□-□ | To learn the software specifications of the CP2E PLCs | Describes the following information for CP2E PLCs. <ul style="list-style-type: none"> • CPU Unit operation • Internal memory • Programming • Settings • CPU Unit built-in functions <ul style="list-style-type: none"> • Interrupts • High-speed counter inputs • Pulse outputs • Serial communications • Ethernet • Other functions |
| SYSMAC CP Series CP1E/CP2E CPU Unit Instructions Reference Manual | W483 | CP1E-E□□D□-□ CP1E-N□□D□-□ CP1E-NA□□D□-□ CP2E-E□□D□-□ CP2E-S□□D□-□ CP2E-N□□D□-□ | To learn programming instructions in detail | Describes each programming instruction in detail. |
| CS/CJ/CP/NSJ Series Communications Commands Reference Manual | W342 | CS1G/H-CPU□□H CS1G/H-CPU□□-V1 CS1D-CPU□□H CS1D-CPU□□S CS1W-SCU□□-V1 CS1W-SCB□□-V1 CJ1G/H-CPU□□H CJ1G-CPU□□P CJ1M-CPU□□ CJ1G-CPU□□ CJ1W-SCU□□-V1 | To learn communications commands for CS/CJ/CP/NSJ-series Controllers in detail | Describes 1) C-mode commands and 2) FINS commands in detail. Read this manual for details on C-mode and FINS commands addressed to CPU Units. |
| CX-One FA Integrated Tool Package Setup Manual | W463 | CXONE-AL□□D-V4 | To install the software provided in the CX-One | Describes the overview of the CX-One FA Integrated Tool Package, and how to install and uninstall the CX-One. |
| CX-Programmer Operation Manual | W446 | | To learn the operation procedures for the CX-Programmer, the Programming Device for Windows computers | Describes the operation procedures for the CX-Programmer. |
| CX-Programmer Operation Manual (Function Blocks/ Structured Text) | W447 | | | |
| CX-Simulator Operation Manual | W366 | | To learn the operation procedures for the CX-Simulator, the Simulation Device for Windows computers | Describes the operation procedures for the CX-Simulator. |
| CX-Integrator Operation Manual | W464 | | To set up and monitor networks | Describes the operation procedures for the CX-Integrator. |

Microsoft, Windows are either registered trademarks or trademarks of Microsoft Corporation in the United States and other countries. Other company names and product names in this document are the trademarks or registered trademarks of their respective companies. The product photographs and figures that are used in this catalog may vary somewhat from the actual products.

OMRON AUTOMATION AMERICAS HEADQUARTERS • Chicago, IL USA • 847.843.7900 • 800.556.6766 • automation.omron.com

OMRON CANADA, INC. • HEAD OFFICE

Toronto, ON, Canada • 416.286.6465 • 866.986.6766 • automation.omron.com

OMRON ELECTRONICS DE MEXICO • HEAD OFFICE

Ciudad de México • 52.55.5901.4300 • 01.800.386.6766 • mela@omron.com

OMRON ELECTRONICS DE MEXICO • SALES OFFICE

San Pedro Garza García, N.L. • 81.12.53.7392 • 01.800.386.6766 • mela@omron.com

OMRON ELECTRONICS DE MEXICO • SALES OFFICE

Eugenio Garza Sada, León, Gto • 01.800.386.6766 • mela@omron.com

OMRON ELETRÔNICA DO BRASIL LTDA • HEAD OFFICE

São Paulo, SP, Brasil • 55.11.2101.6300 • www.omron.com.br

OMRON ARGENTINA • SALES OFFICE

Buenos Aires, Argentina • +54.11.4521.8630 • +54.11.4523.8483
mela@omron.com

OTHER OMRON LATIN AMERICA SALES

+54.11.4521.8630 • +54.11.4523.8483 • mela@omron.com

Authorized Distributor:

Controllers & I/O

- Machine Automation Controllers (MAC) • Motion Controllers
- Programmable Logic Controllers (PLC) • Temperature Controllers • Remote I/O

Robotics

- Industrial Robots • Mobile Robots

Operator Interfaces

- Human Machine Interface (HMI)

Motion & Drives

- Machine Automation Controllers (MAC) • Motion Controllers • Servo Systems
- Frequency Inverters

Vision, Measurement & Identification

- Vision Sensors & Systems • Measurement Sensors • Auto Identification Systems

Sensing

- Photoelectric Sensors • Fiber-Optic Sensors • Proximity Sensors
- Rotary Encoders • Ultrasonic Sensors

Safety

- Safety Light Curtains • Safety Laser Scanners • Programmable Safety Systems
- Safety Mats and Edges • Safety Door Switches • Emergency Stop Devices
- Safety Switches & Operator Controls • Safety Monitoring/Force-guided Relays

Control Components

- Power Supplies • Timers • Counters • Programmable Relays
- Digital Panel Meters • Monitoring Products

Switches & Relays

- Limit Switches • Pushbutton Switches • Electromechanical Relays
- Solid State Relays

Software

- Programming & Configuration • Runtime