

120×120×25 mm

San Ace 120 9GA type Low Power Consumption Fan 



General Specifications

- Material Frame: Plastic (Flammability: UL 94V-0), Impeller: Plastic (Flammability: UL 94V-0)
- Expected life See the table below. (L10 life: 90% survival rate for continuous operation in free air at 60°C, rated voltage)
- Motor protection function Locked rotor burnout protection, Reverse polarity protection
For details, please refer to p. 547.
- Dielectric strength 50/60 Hz, 500 VAC, for 1 minute (between lead wire conductors and frame)
- Insulation resistance 10 MΩ or more with a 500 VDC megger (between lead wire conductors and frame)
- Sound pressure level (SPL) At 1 m away from the air inlet
- Storage temperature -30 to +70°C (Non-condensing)
- Lead wire ⊕Red ⊖Black Sensor Yellow Control Brown
(For models without PWM control function, there is no speed control wiring.)
- Mass 280 g

Specifications

The models listed below **have ribs and pulse sensors with PWM control function**. For models without ribs, append "1" to the end of model numbers.

Model no.	Rated voltage [V]	Operating voltage range [V]	PWM duty cycle* [%]	Rated current [A]	Rated input [W]	Rated speed [min ⁻¹]	Max. airflow [m ³ /min] [CFM]	Max. static pressure [Pa] [inchH ₂ O]	SPL [dB (A)]	Operating temperature [°C]	Expected life [h]
9GA1212P4G001	12	10.2 to 13.8	100	0.93	11.16	6400	3.8 134	365 1.47	57	-20 to +70	40000/60°C (70000/40°C)
			25	0.16	1.92	2550	1.5 53	60 0.24	34		
9GA1212P4S001			100	0.61	7.32	5400	3.2 113	260 1.04	54		
			25	0.16	1.92	2550	1.5 53	60 0.24	34		
9GA1224P4G001	24	20.4 to 27.6	100	0.47	11.28	6400	3.8 134	365 1.47	57		
			25	0.1	2.4	2550	1.5 53	60 0.24	34		
9GA1224P4S001			100	0.31	7.44	5400	3.2 113	260 1.04	54		
			25	0.1	2.4	2550	1.5 53	60 0.24	34		
9GA1248P4G001	48	40.8 to 53	100	0.24	11.52	6400	3.8 134	365 1.47	57		
			25	0.08	3.84	2550	1.5 53	60 0.24	34		
9GA1248P4S001			100	0.16	7.68	5400	3.2 113	260 1.04	54		
			25	0.08	3.84	2550	1.5 53	60 0.24	34		

* PWM frequency: 25 kHz. Fan does not rotate when PWM duty cycle is 0%.

The following sensor and control options are available for selection.

Available for all models. **Pulse sensor**

Differs according to the model. Refer to the table on pp. 572 to 573. **Without sensor** **Lock sensor**

The models listed below **have ribs and pulse sensors**. For models without ribs, append "1" to the end of model numbers.

Model no.	Rated voltage [V]	Operating voltage range [V]	Rated current [A]	Rated input [W]	Rated speed [min ⁻¹]	Max. airflow [m ³ /min] [CFM]	Max. static pressure [Pa] [inchH ₂ O]	SPL [dB (A)]	Operating temperature [°C]	Expected life [h]
9GA1212G4001	12	7 to 13.8	0.93	11.16	6400	3.8 134	365 1.47	57	-20 to +70	40000/60°C (70000/40°C)
9GA1212S4001			0.61	7.32	5400	3.2 113	260 1.04	54		
9GA1224G4001	24	14 to 27.6	0.47	11.28	6400	3.8 134	365 1.47	57		
9GA1224S4001			0.31	7.44	5400	3.2 113	260 1.04	54		
9GA1248G4001	48	36 to 53	0.24	11.52	6400	3.8 134	365 1.47	57		
9GA1248S4001			0.16	7.68	5400	3.2 113	260 1.04	54		

The following sensor and control options are available for selection.

Available for all models. **PWM control**

Differs according to the model. Refer to the table on pp. 572 to 573. **Without sensor** **Lock sensor**

Airflow - Static Pressure Characteristics / PWM Duty - Speed Characteristics Example

DC Fan 120 mm sq.

9GA1212P4G001 With pulse sensor with PWM control function

PWM duty cycle

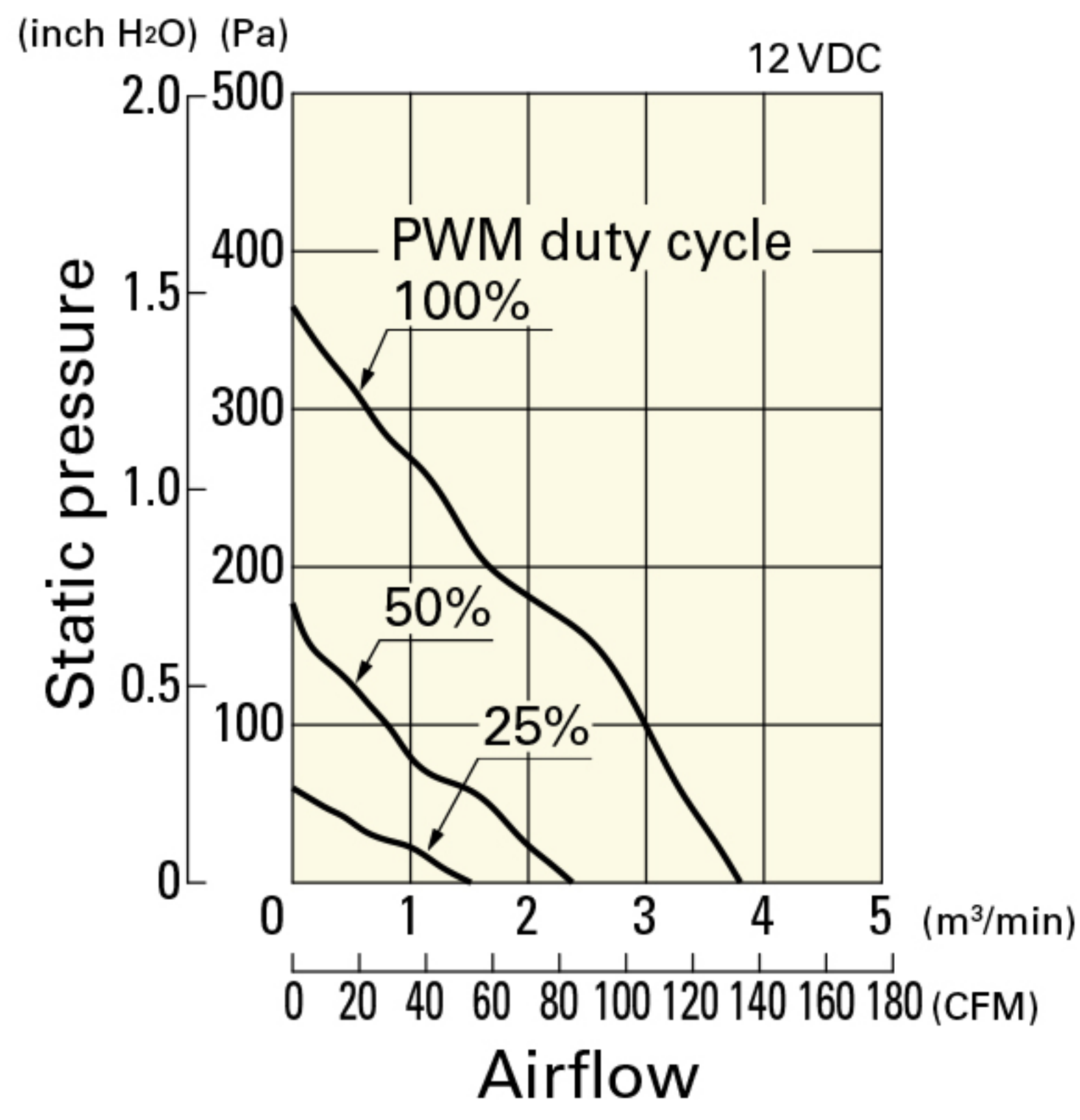

Operating voltage range

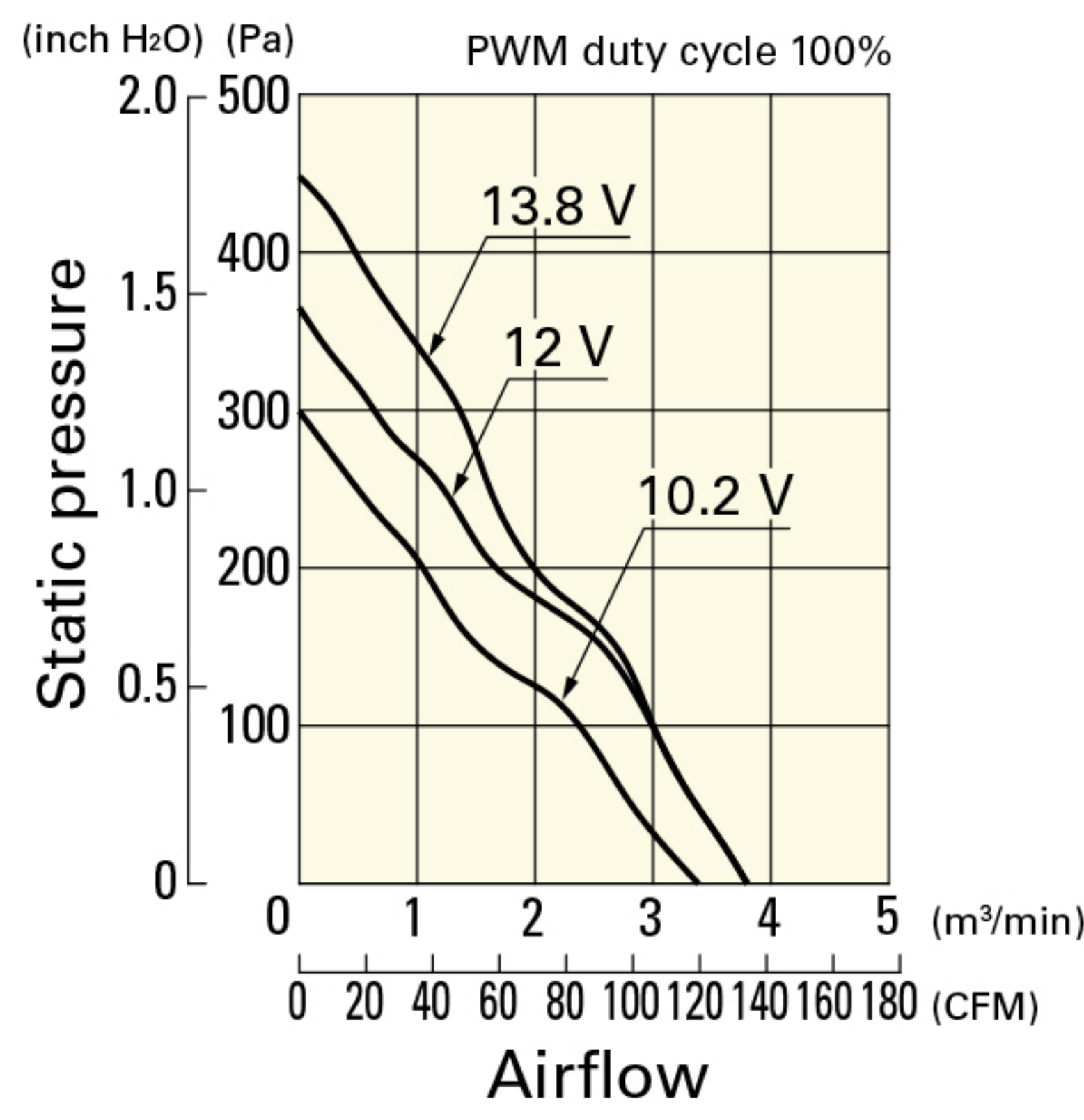

PWM duty - Speed characteristics example

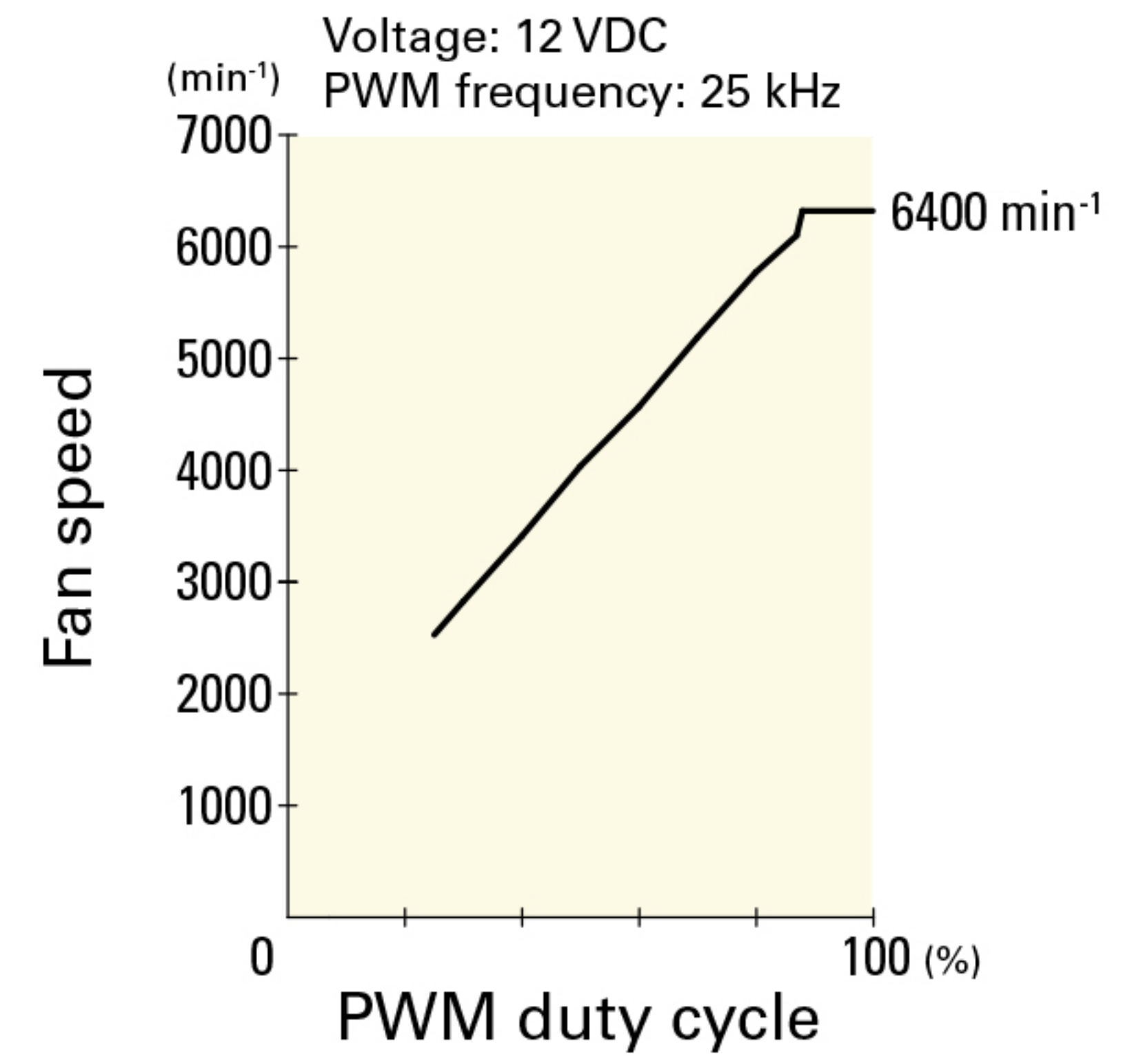

9GA1212P4S001 With pulse sensor with PWM control function

PWM duty cycle

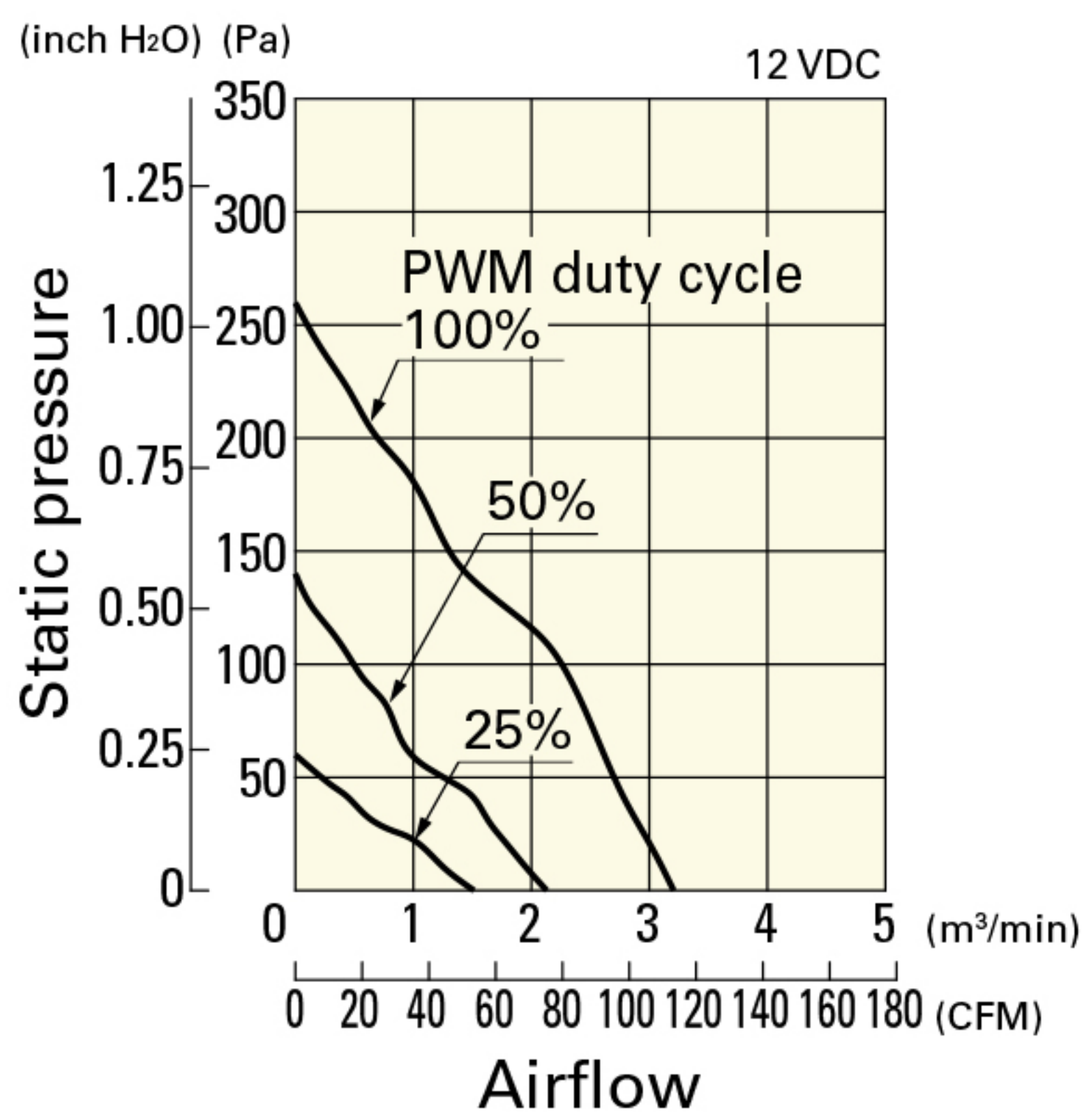

Operating voltage range

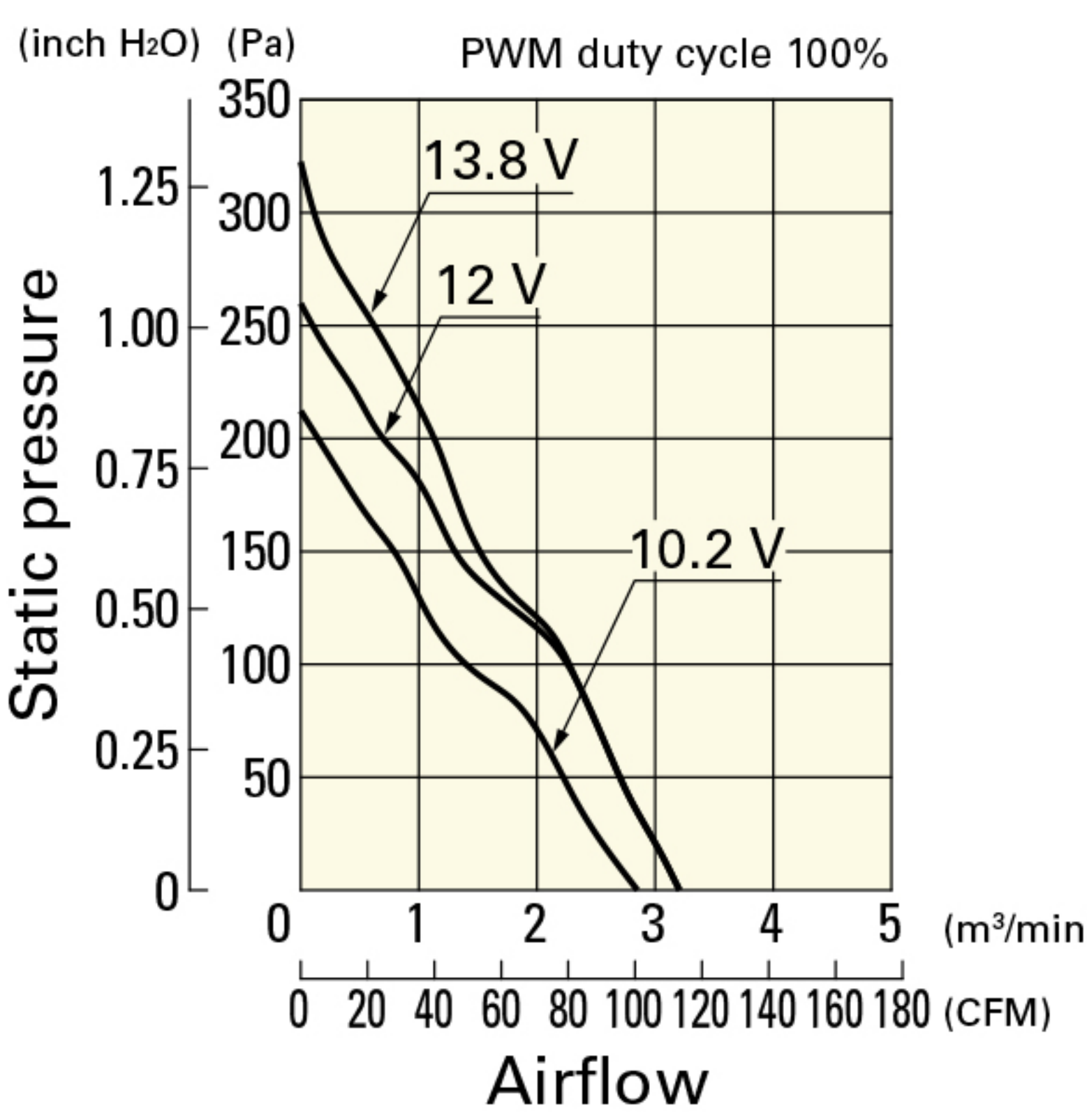

PWM duty - Speed characteristics example

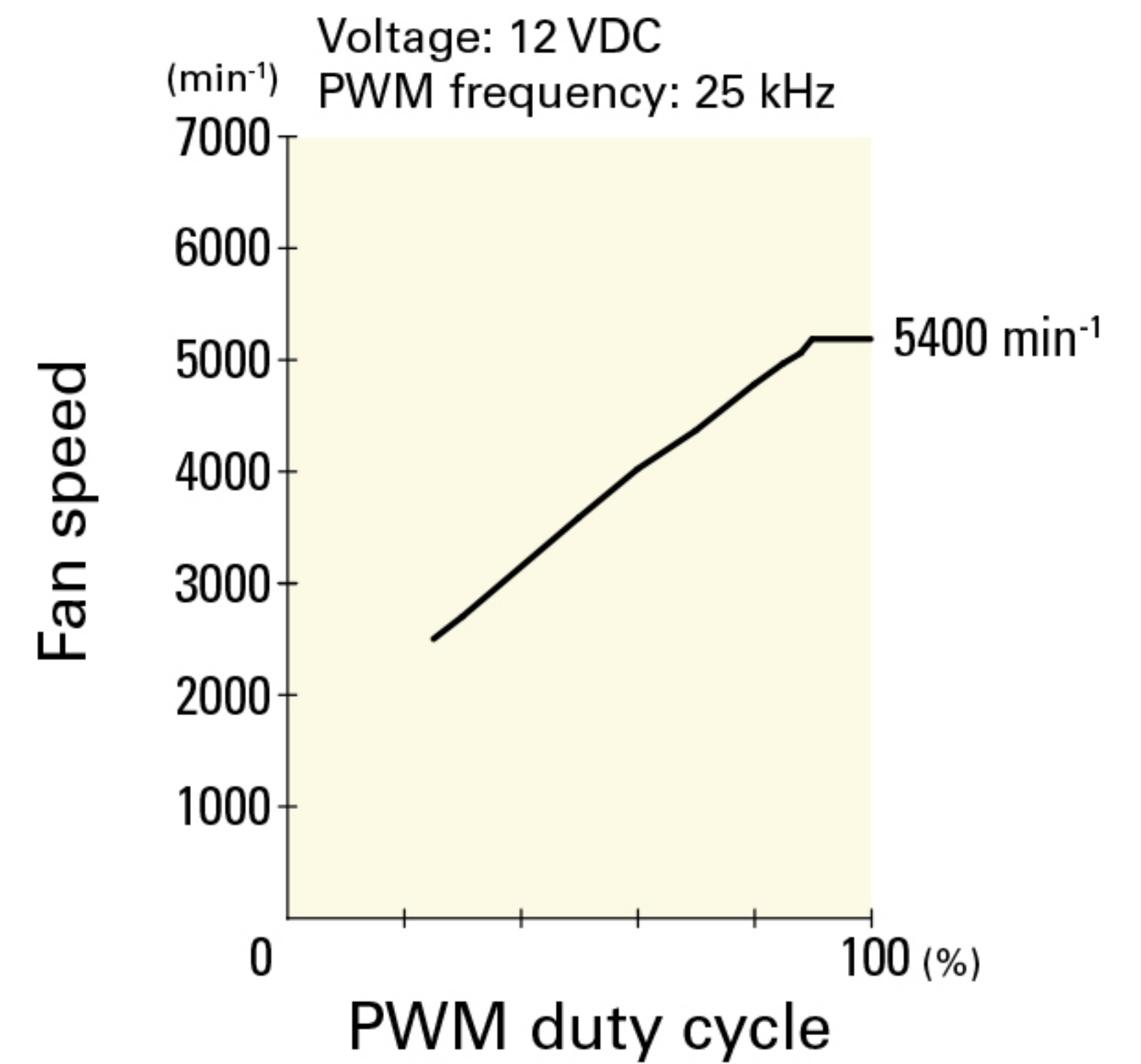

9GA1224P4G001 With pulse sensor with PWM control function

PWM duty cycle

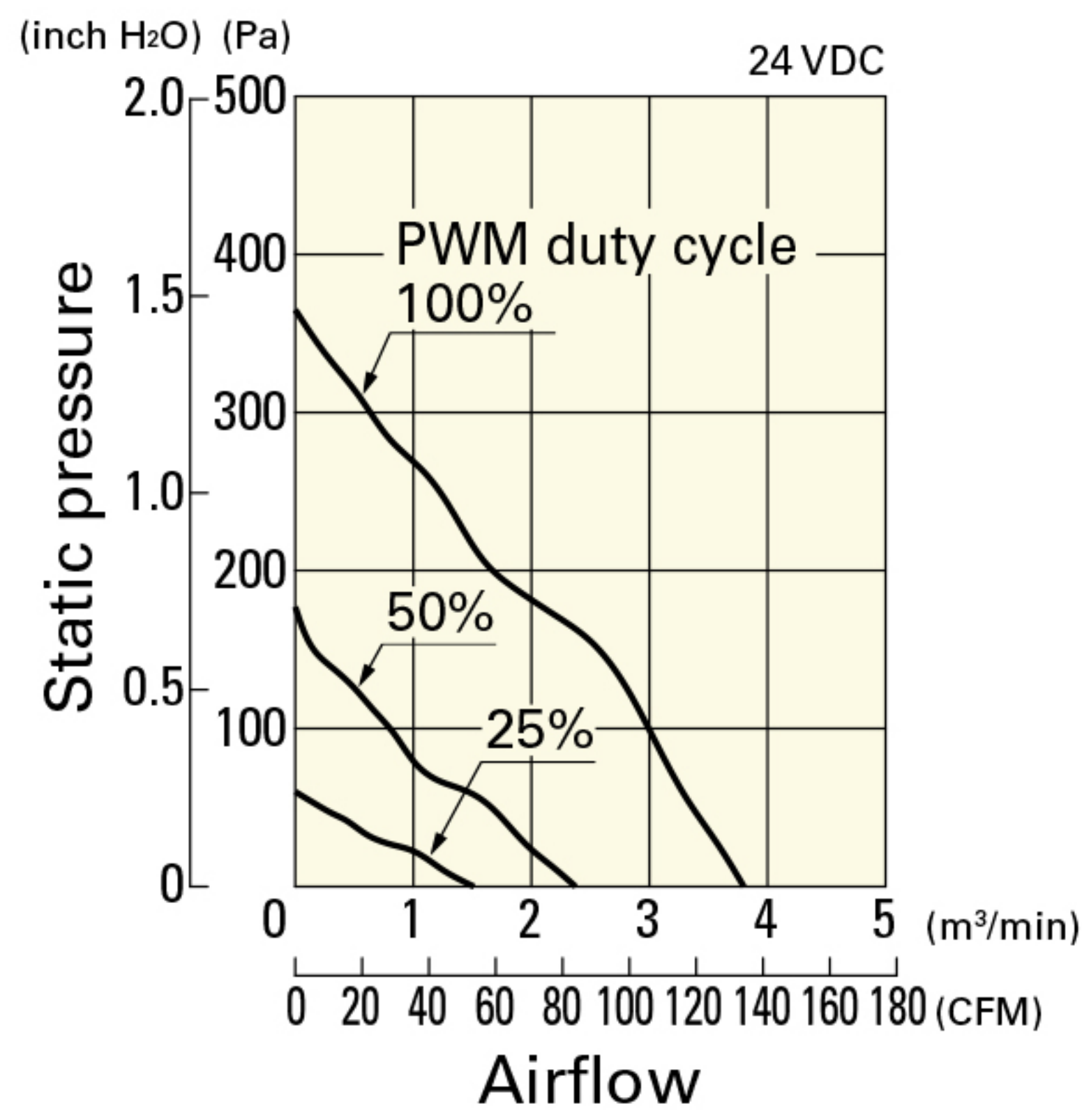

Operating voltage range

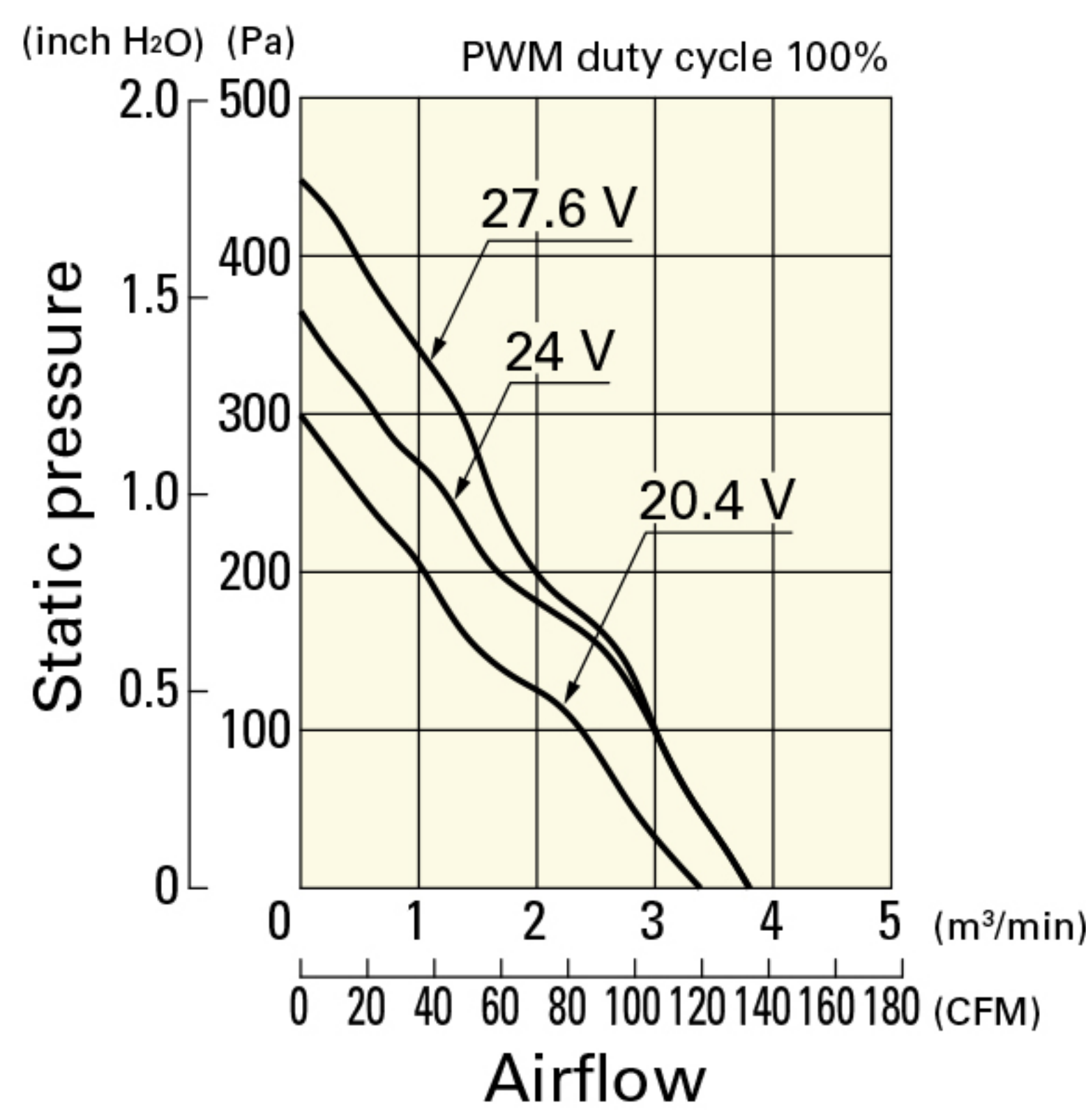

PWM duty - Speed characteristics example

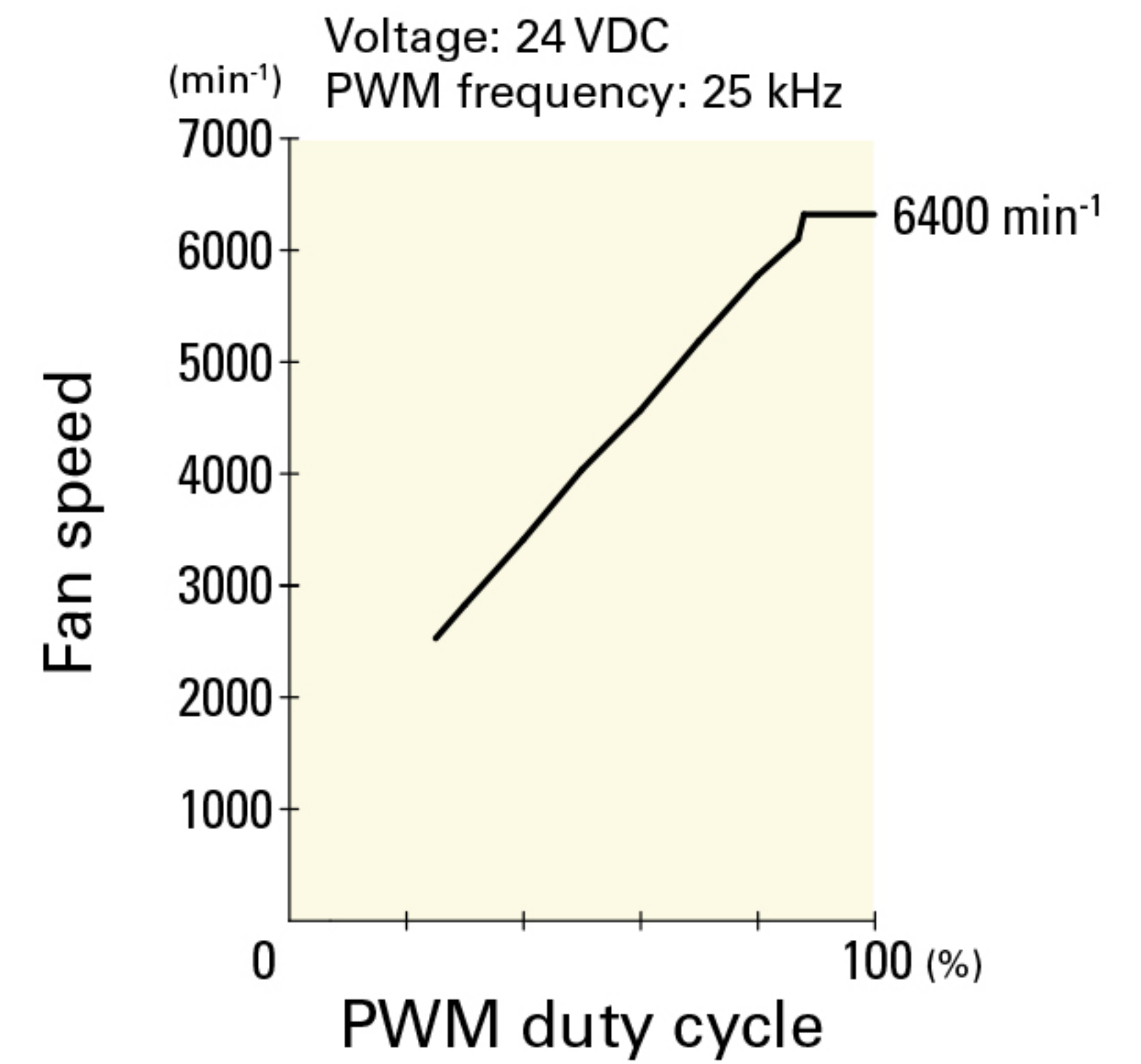

9GA1224P4S001 With pulse sensor with PWM control function

PWM duty cycle

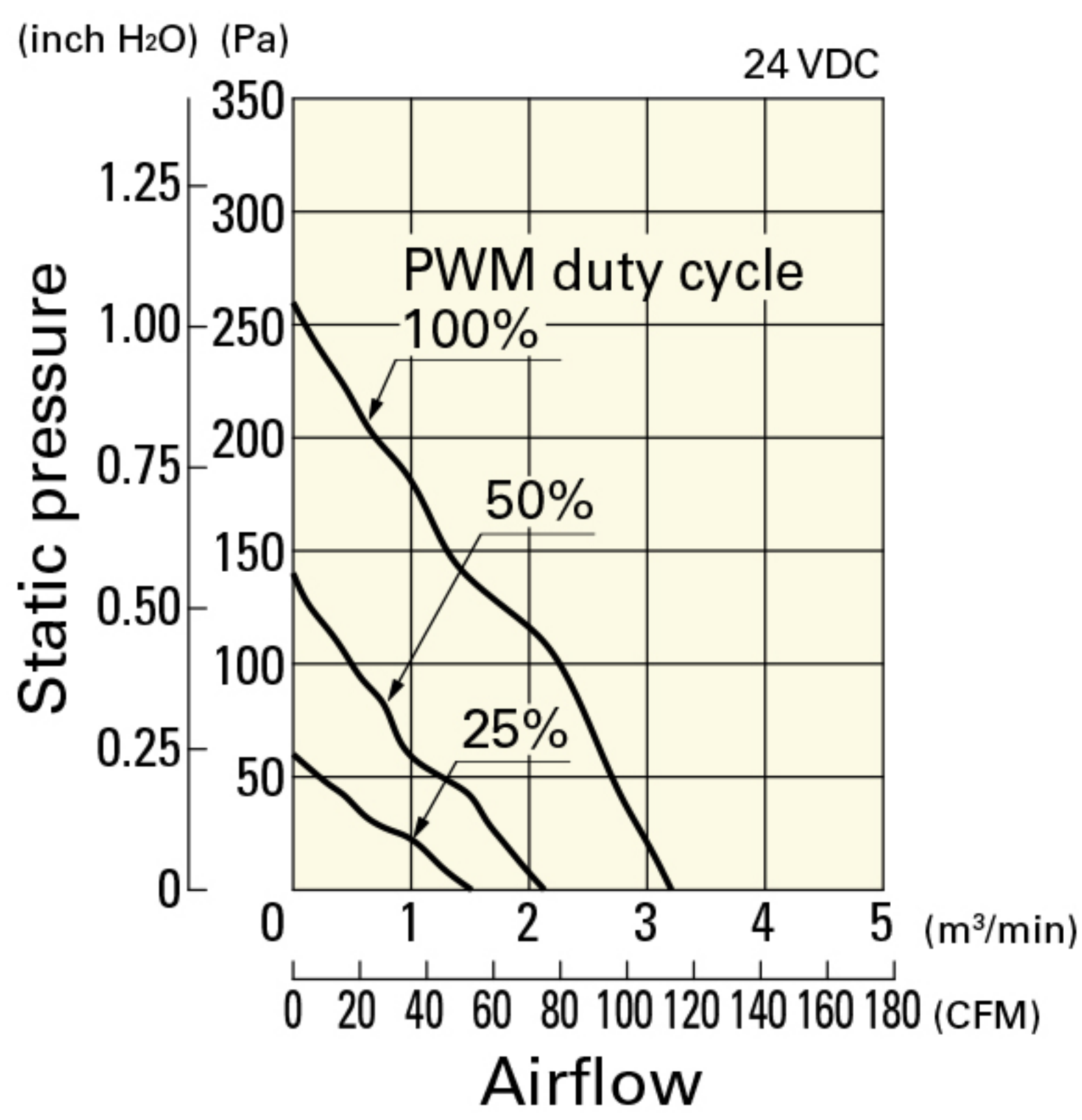

Operating voltage range

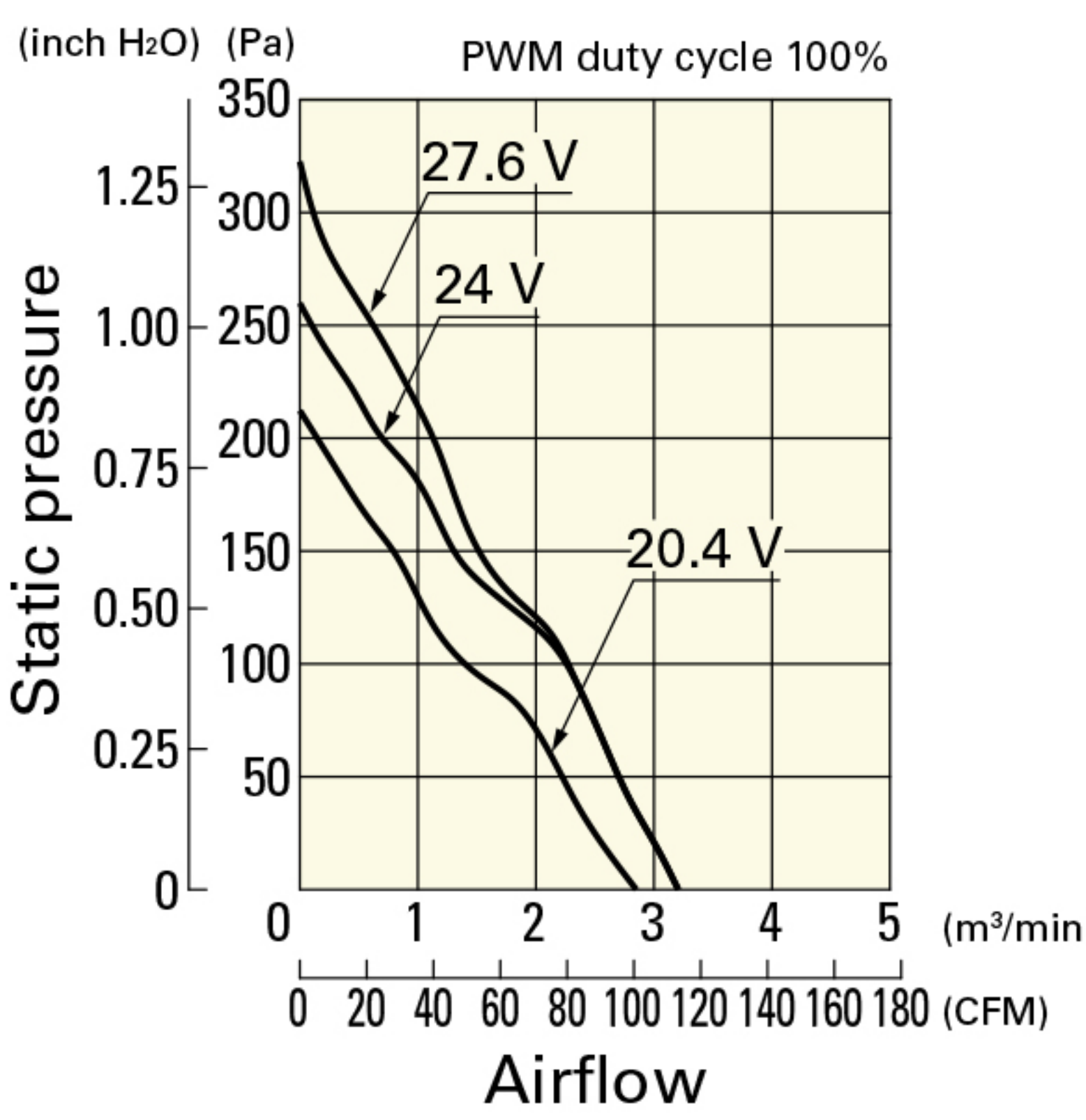

PWM duty - Speed characteristics example

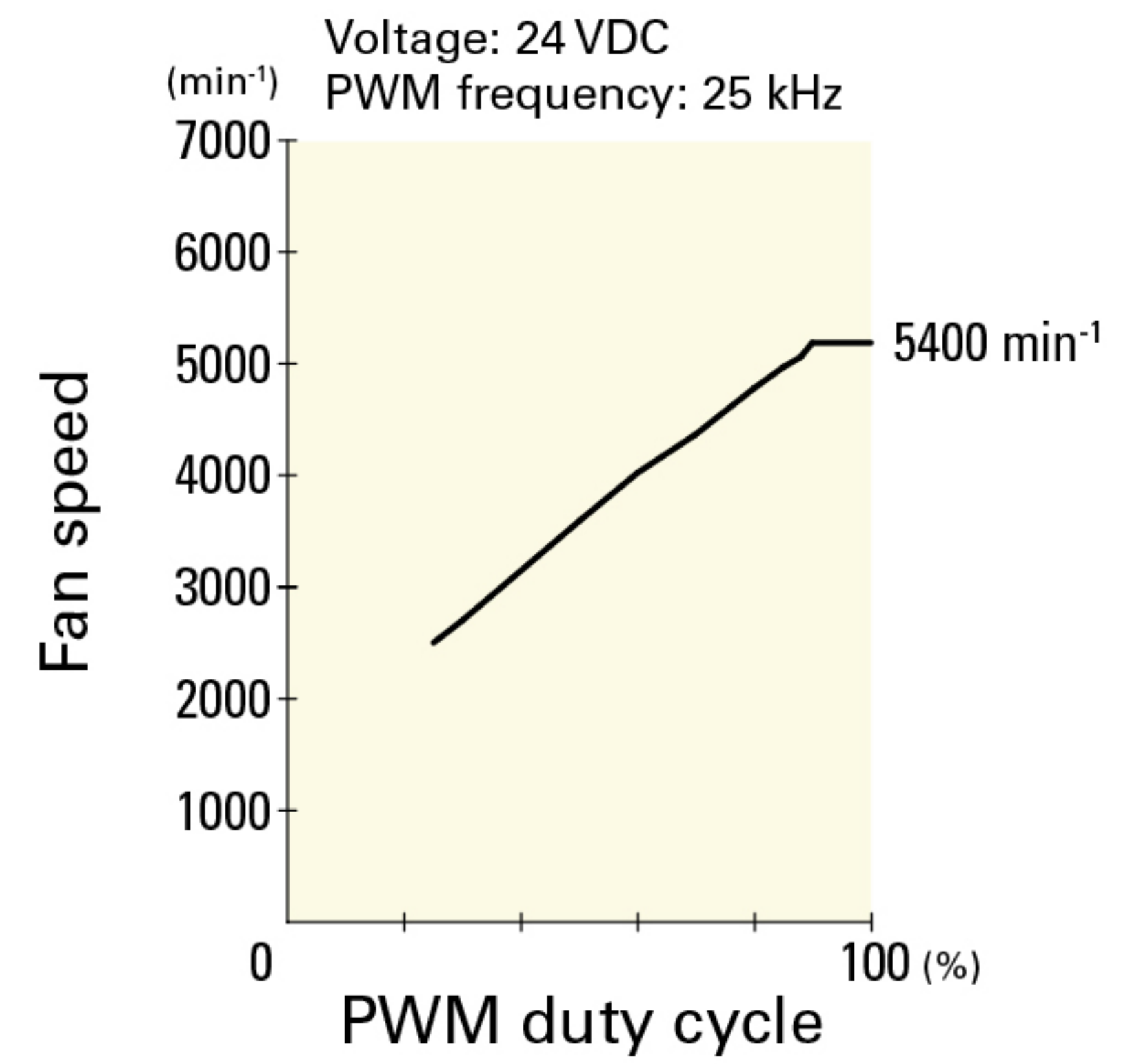

Airflow - Static Pressure Characteristics / PWM Duty - Speed Characteristics Example

9GA1248P4G001 With pulse sensor with PWM control function

PWM duty cycle

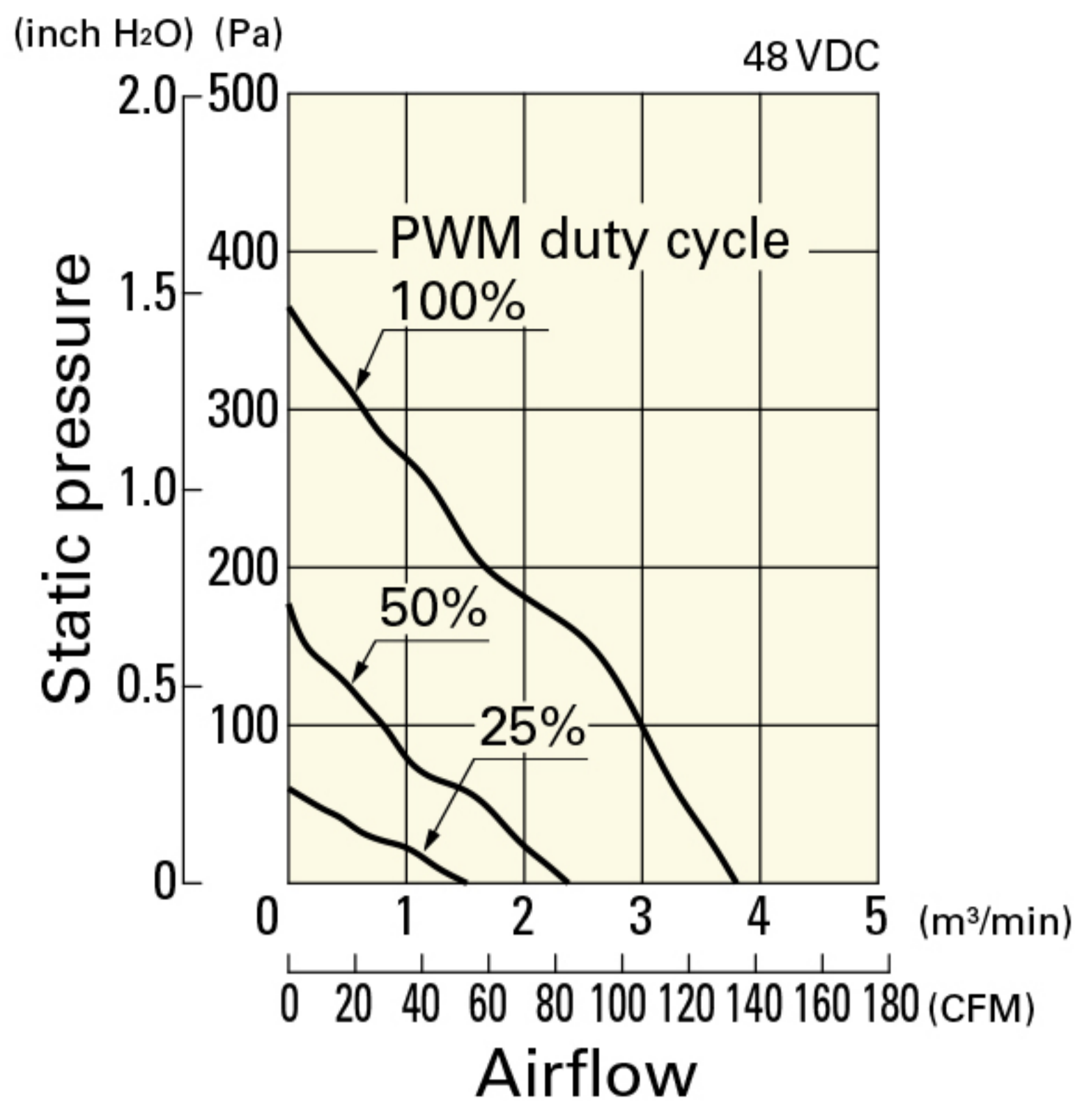

Operating voltage range

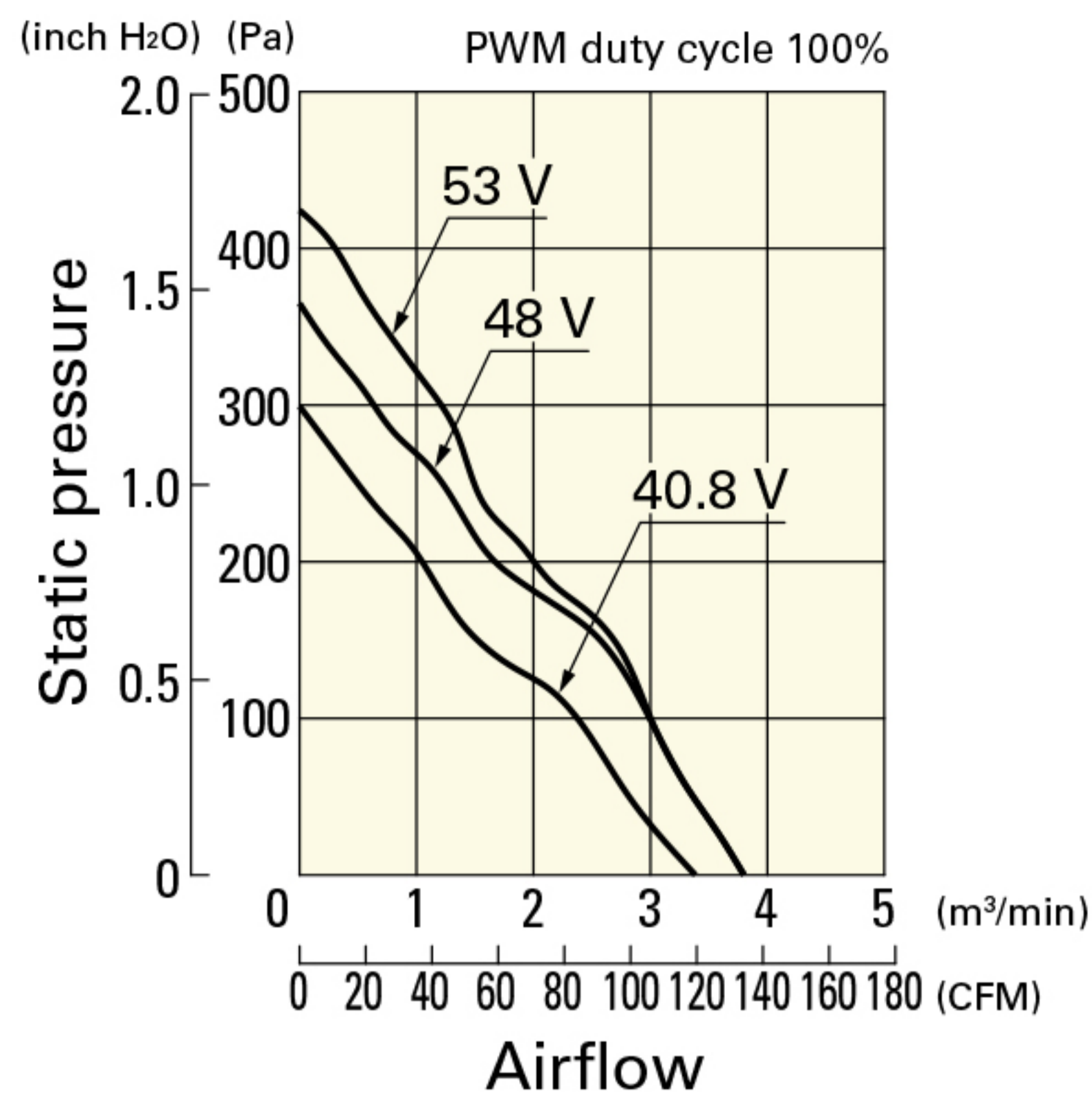

PWM duty - Speed characteristics example

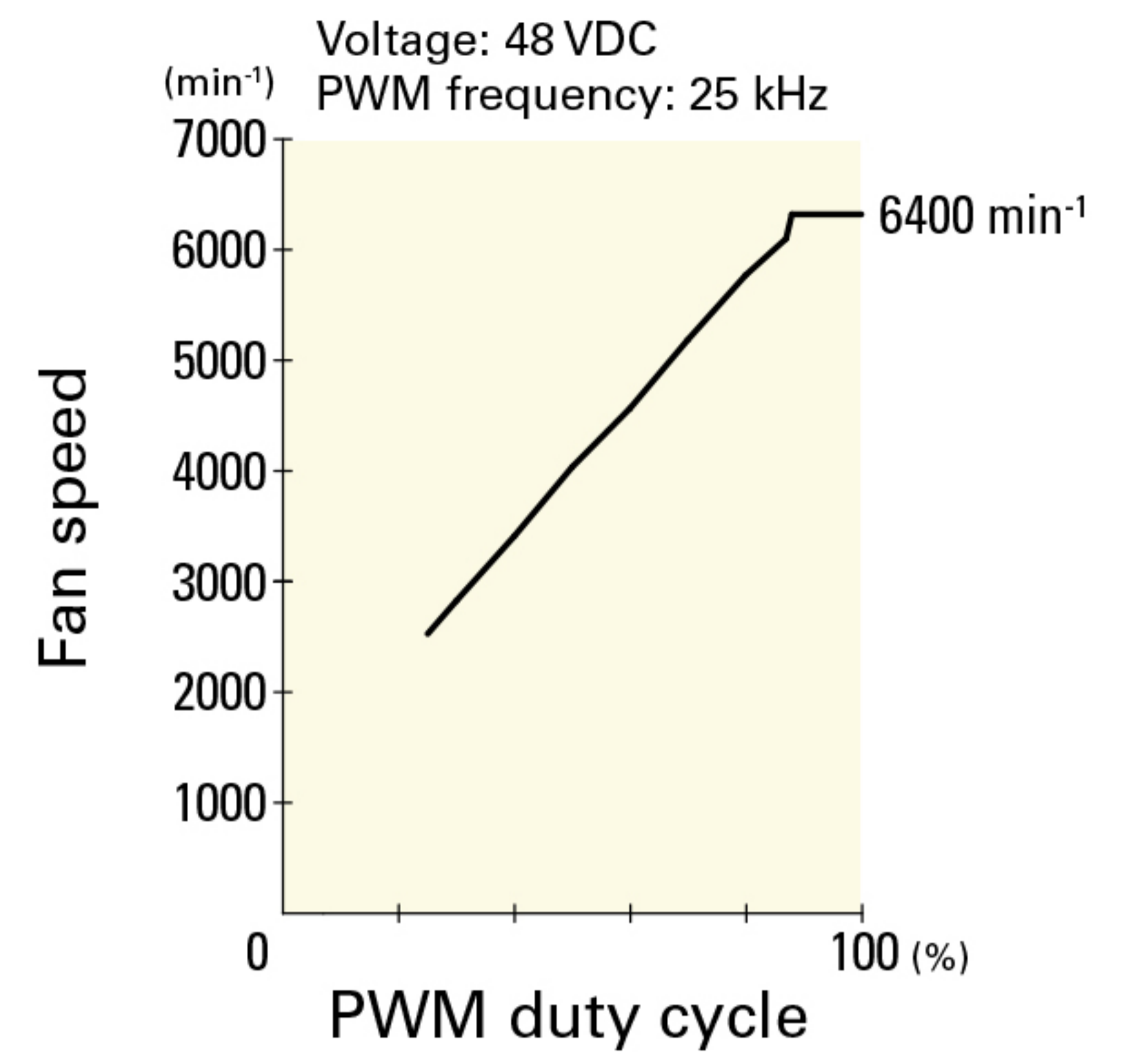

9GA1248P4S001 With pulse sensor with PWM control function

PWM duty cycle

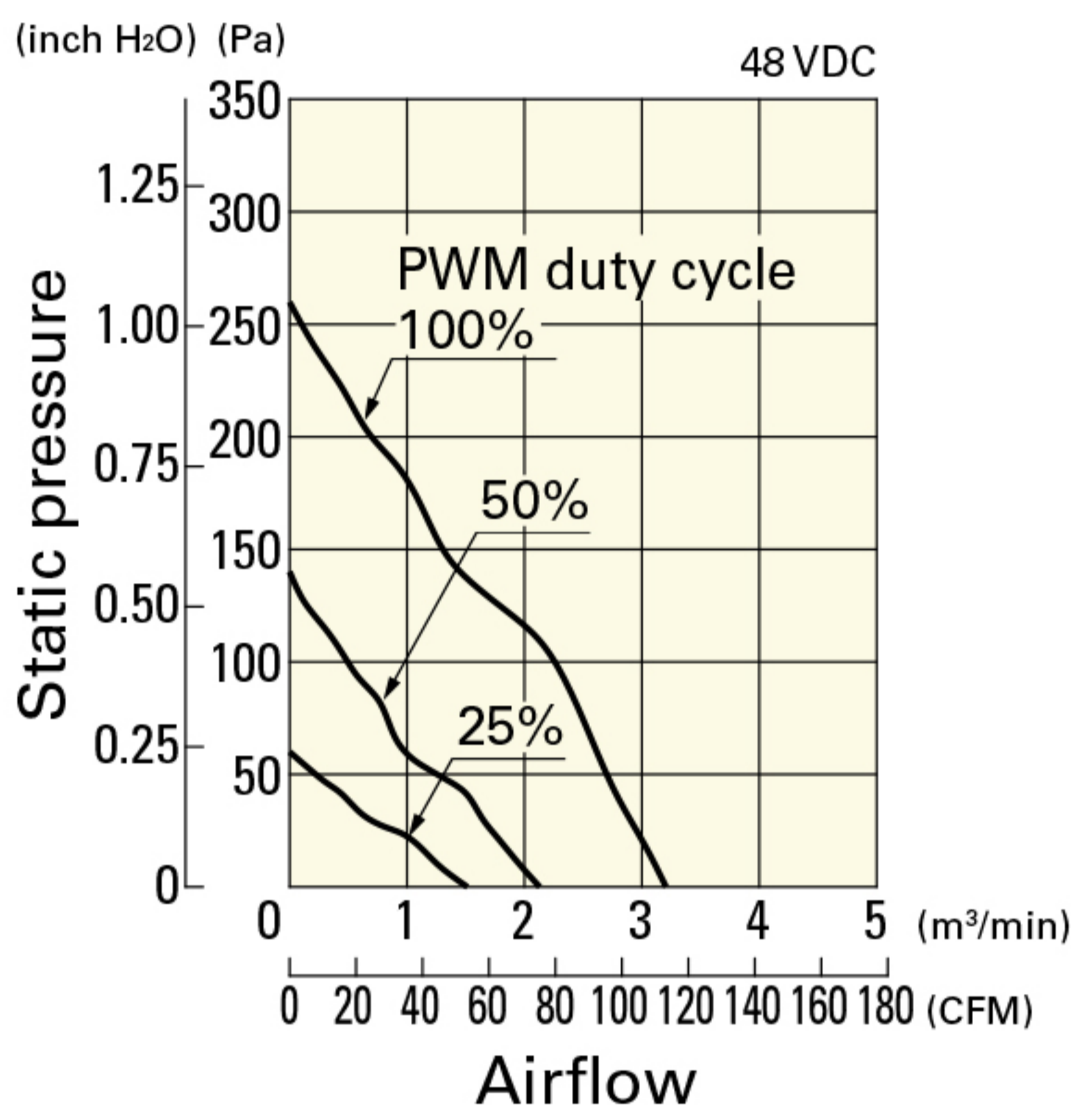

Operating voltage range

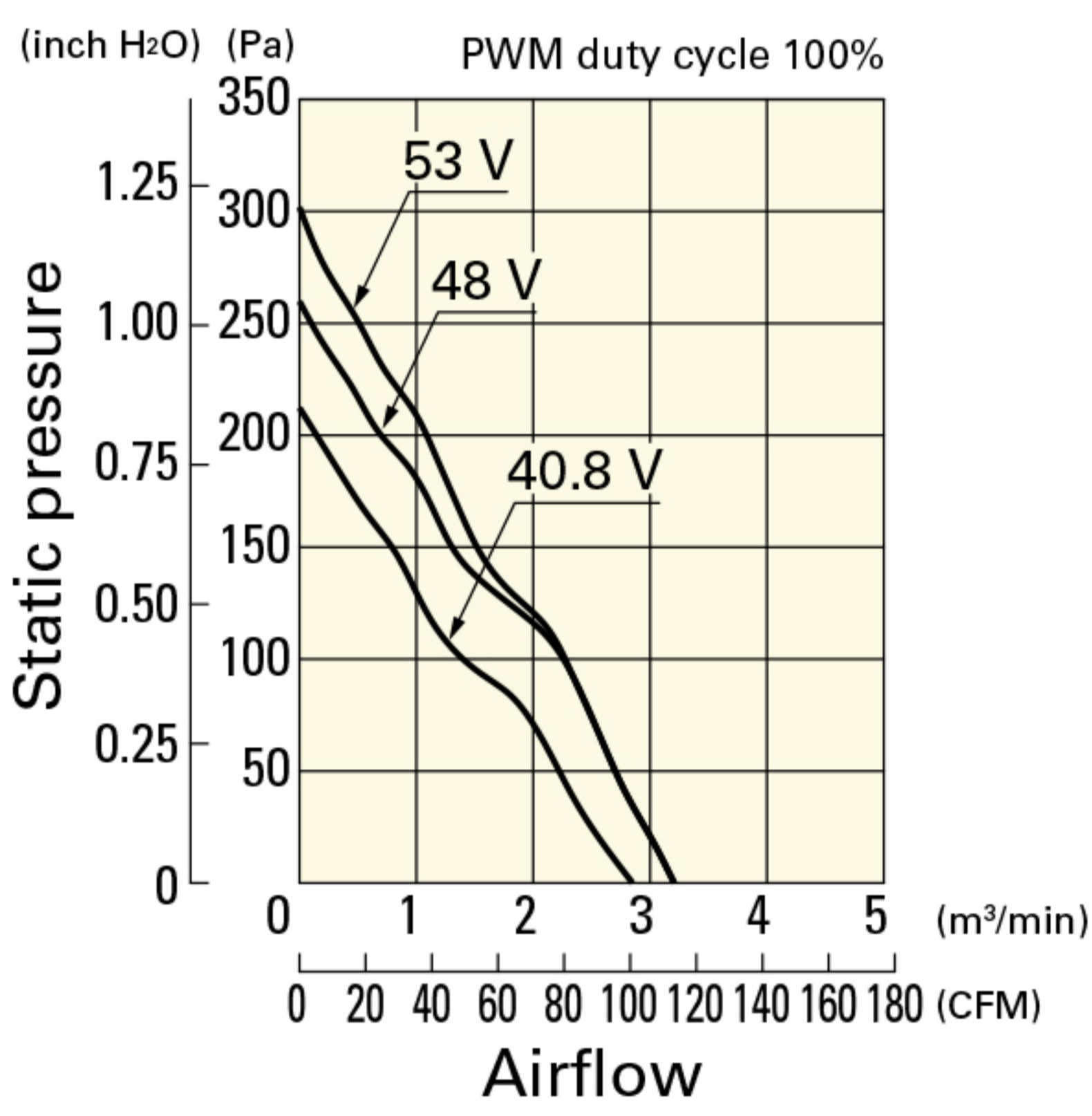

PWM duty - Speed characteristics example

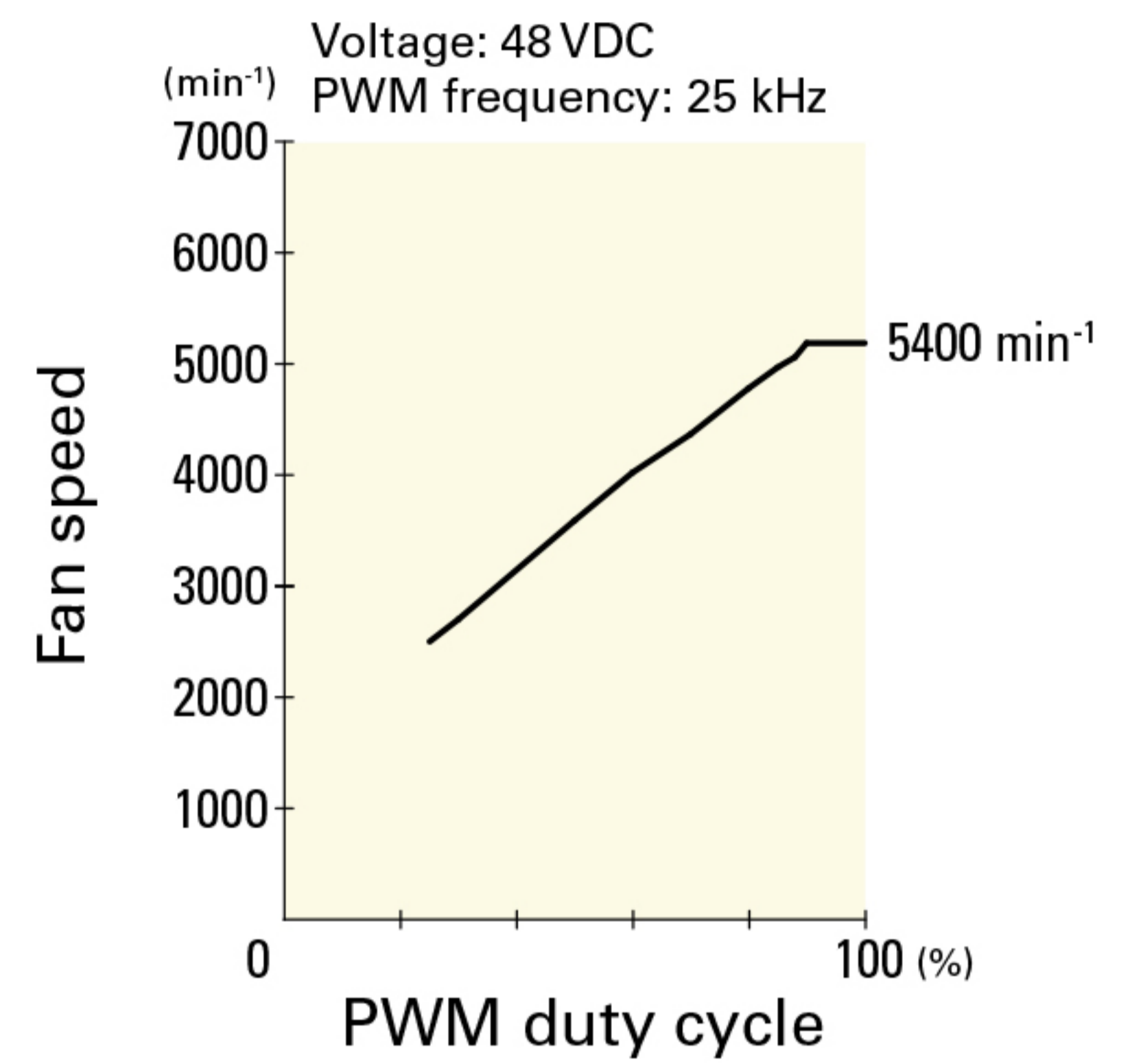

9GA1212G4001 With pulse sensor

Operating voltage range

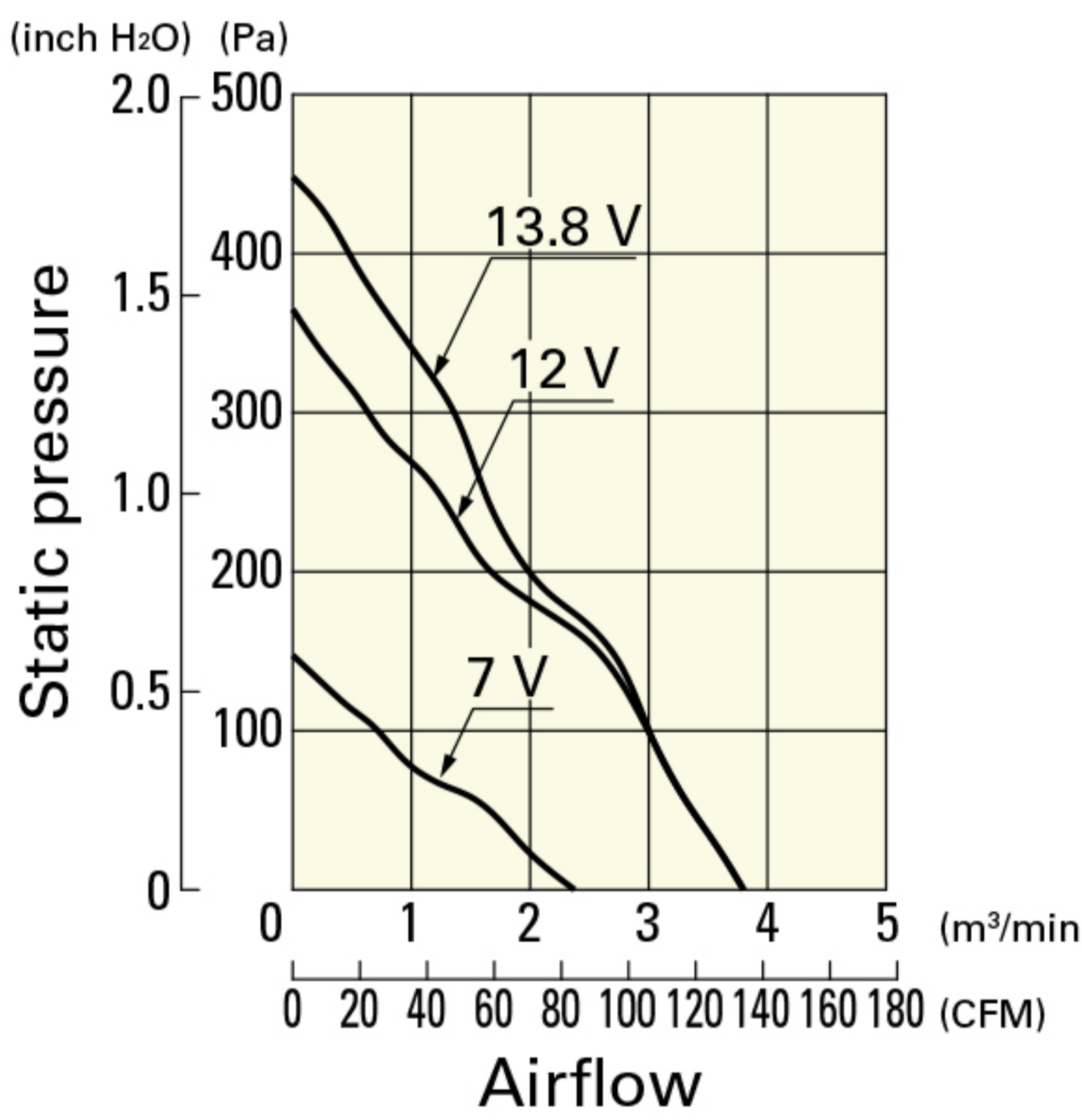

9GA1212S4001 With pulse sensor

Operating voltage range

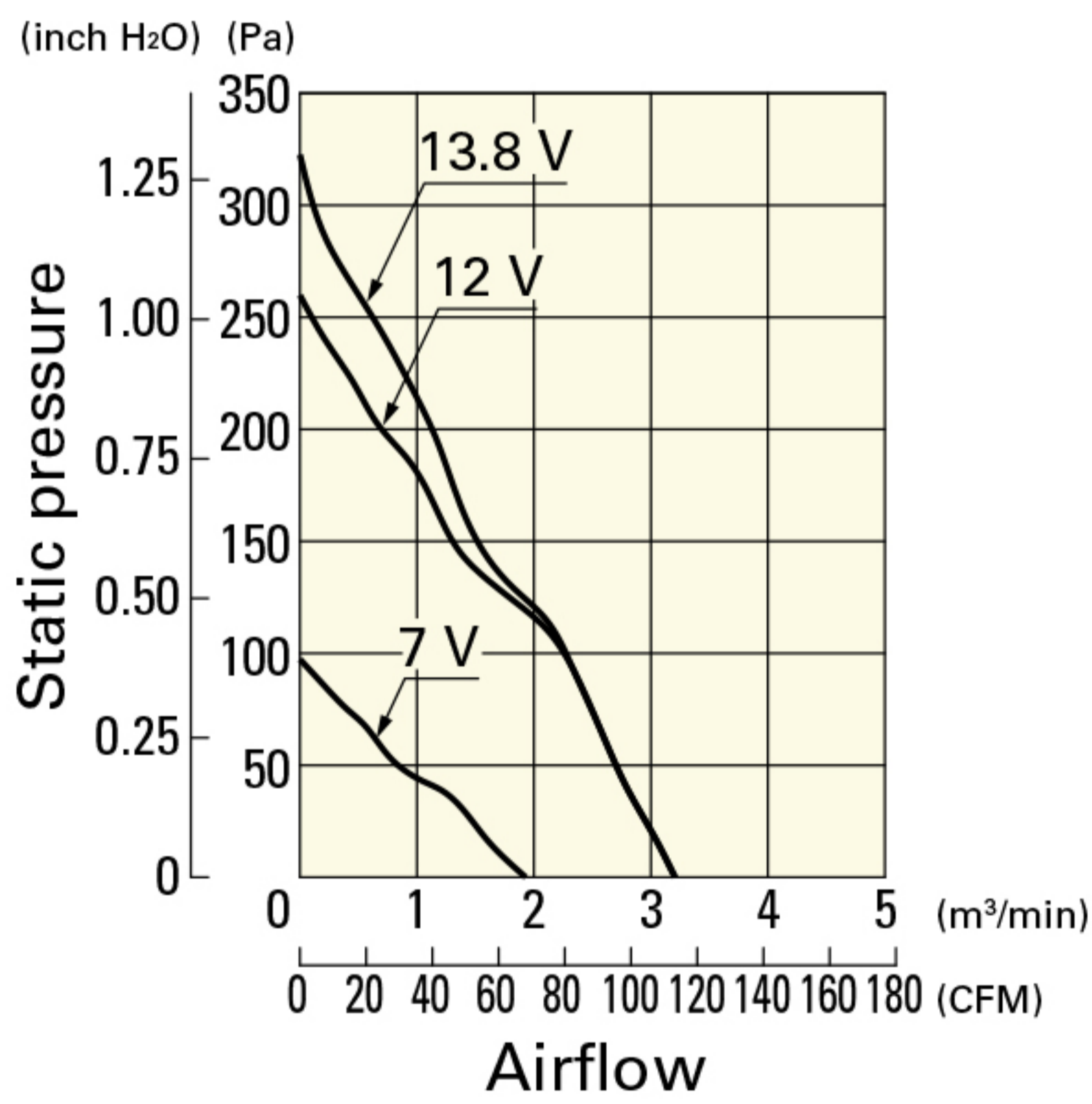

9GA1224G4001 With pulse sensor

Operating voltage range

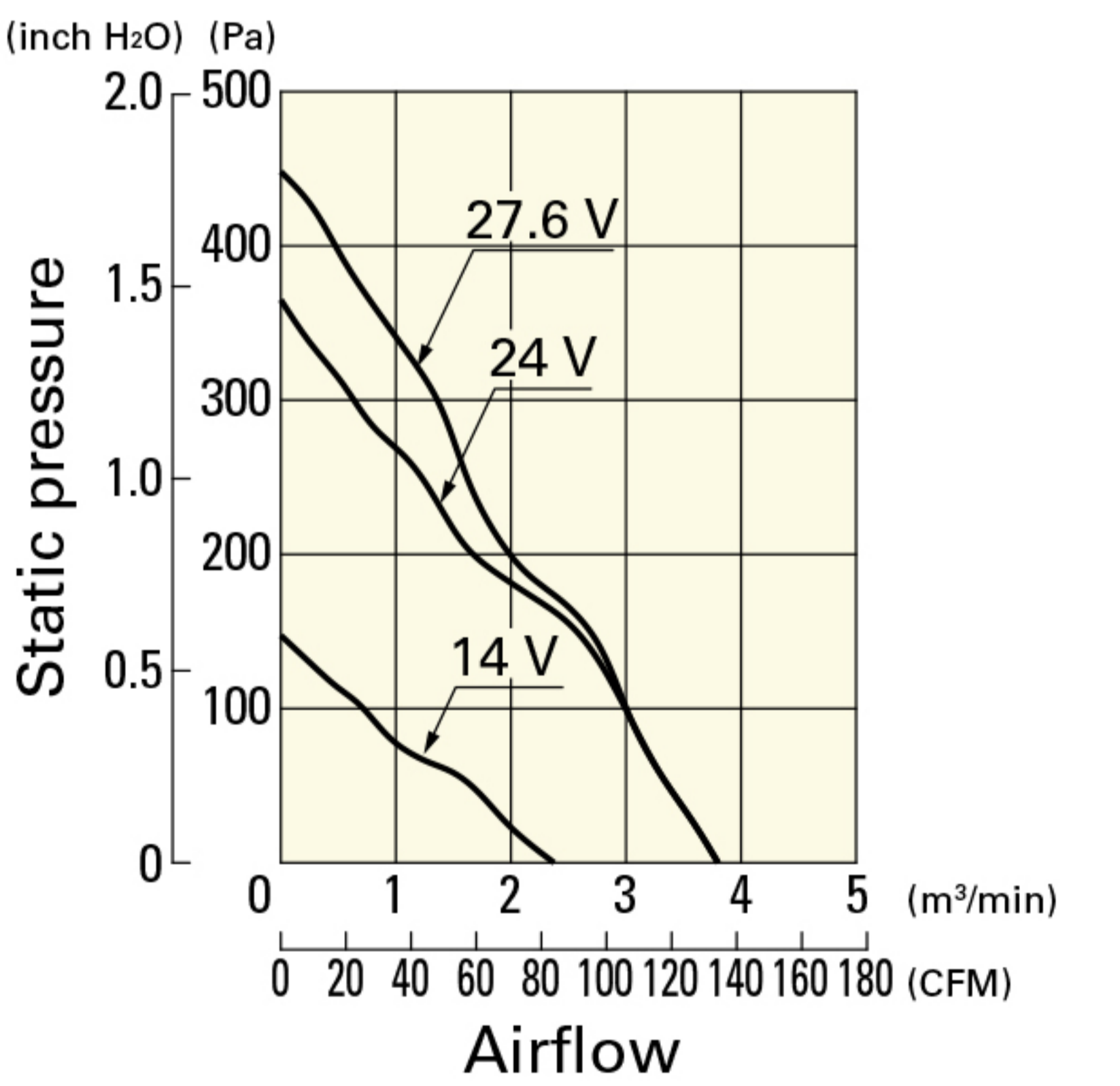

9GA1224S4001 With pulse sensor

Operating voltage range

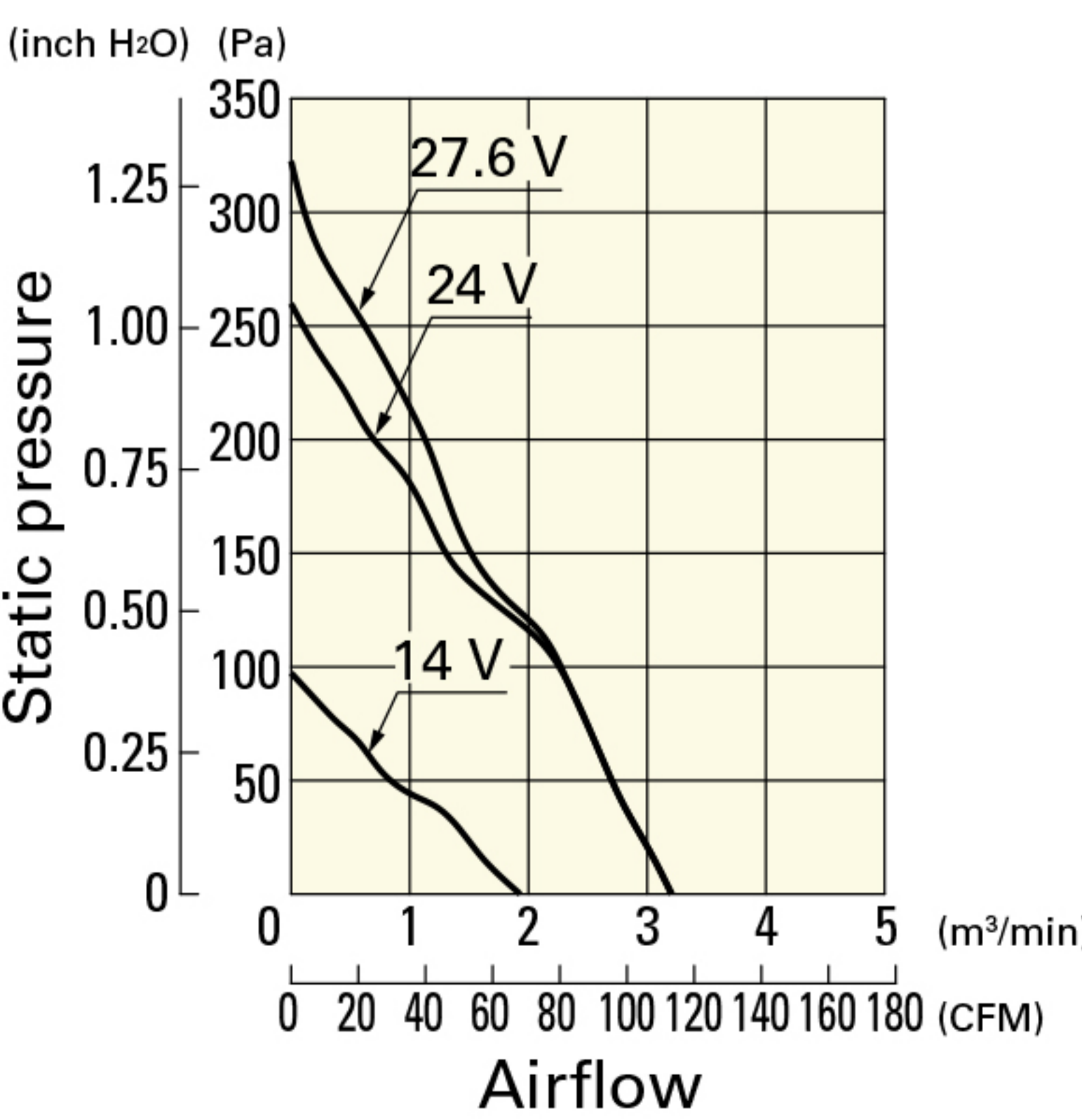

9GA1248G4001 With pulse sensor

Operating voltage range

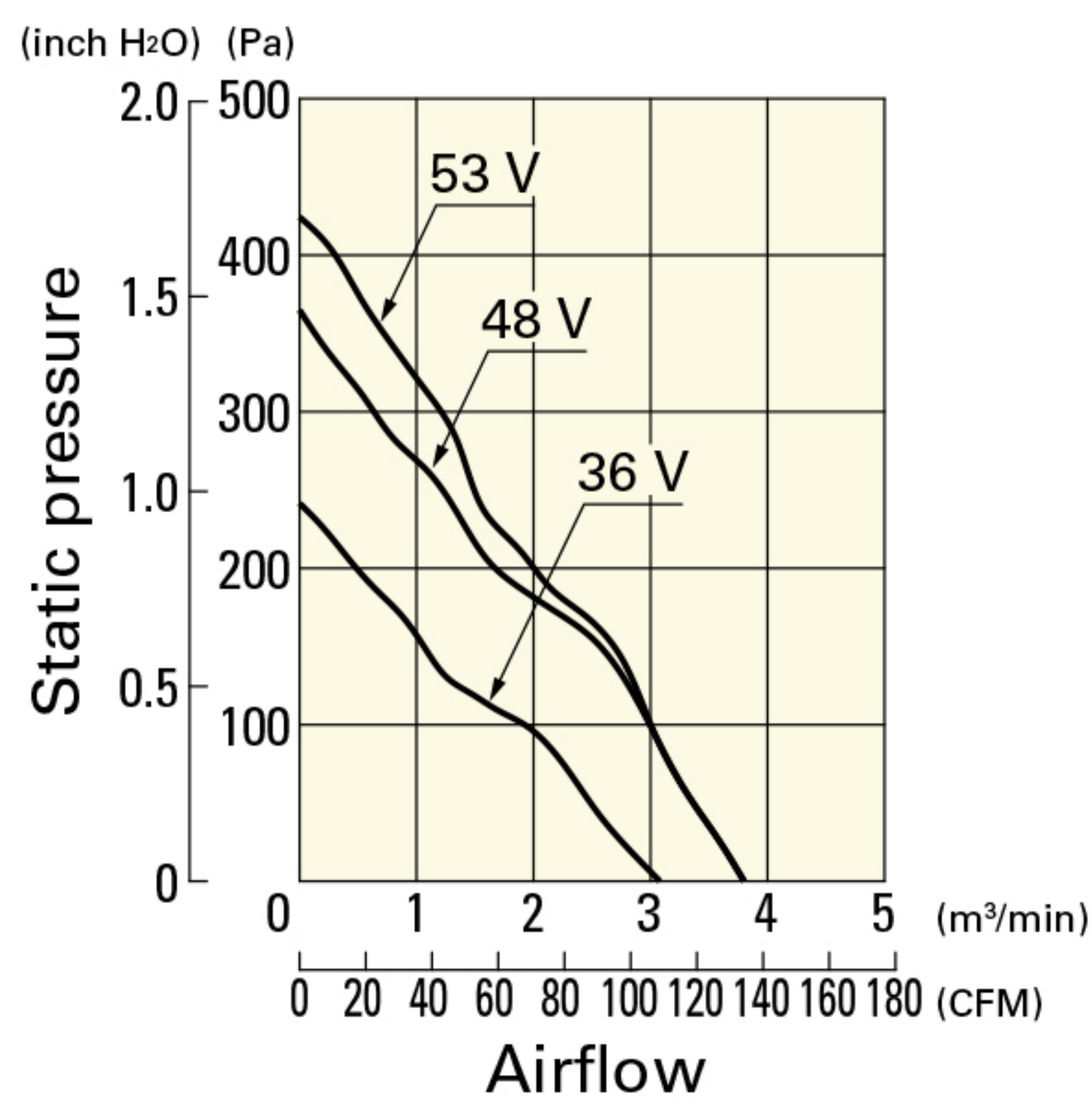

9GA1248S4001 With pulse sensor

Operating voltage range

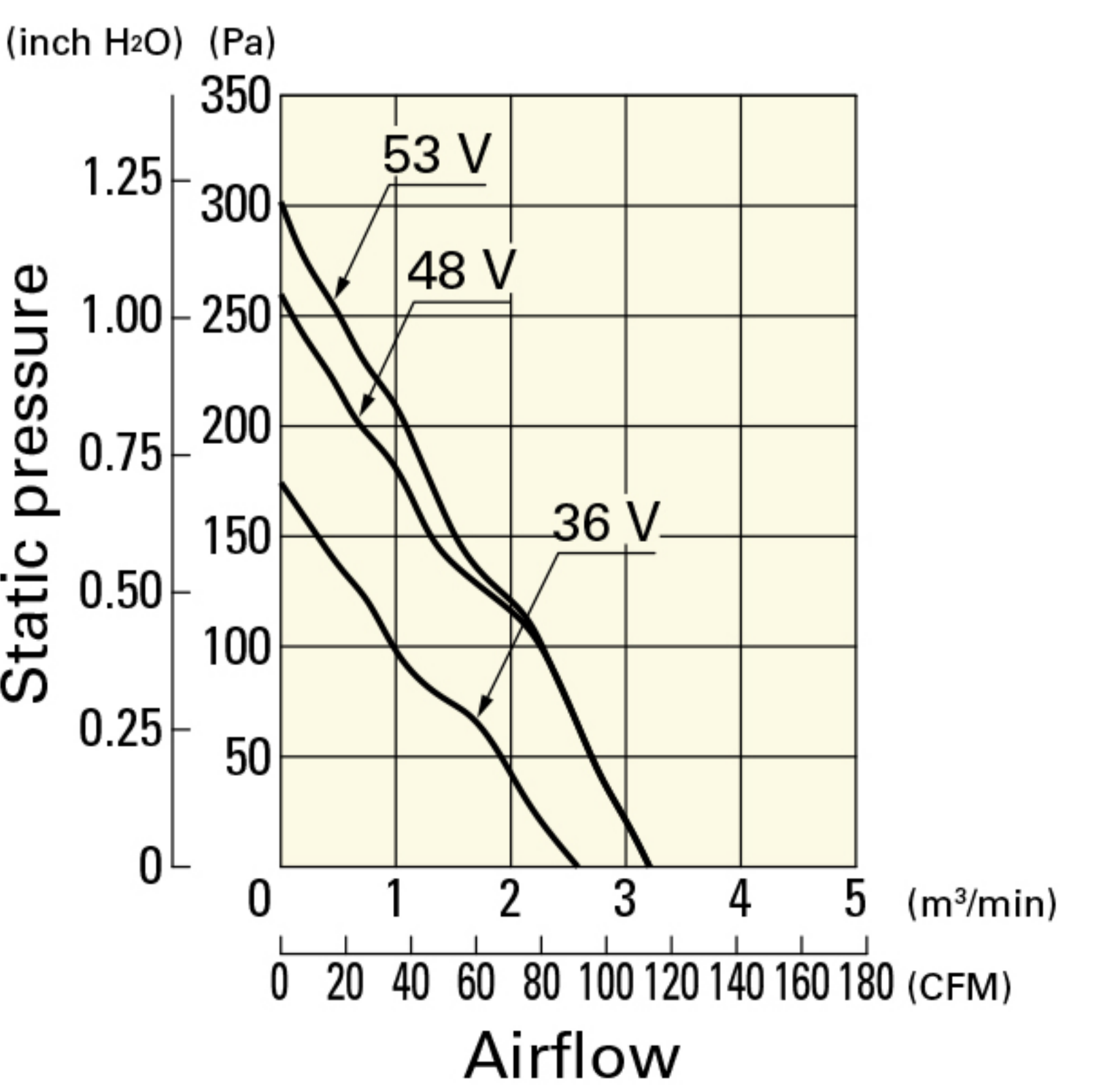

Dimensions (unit: mm) (With pulse sensor with PWM control function)

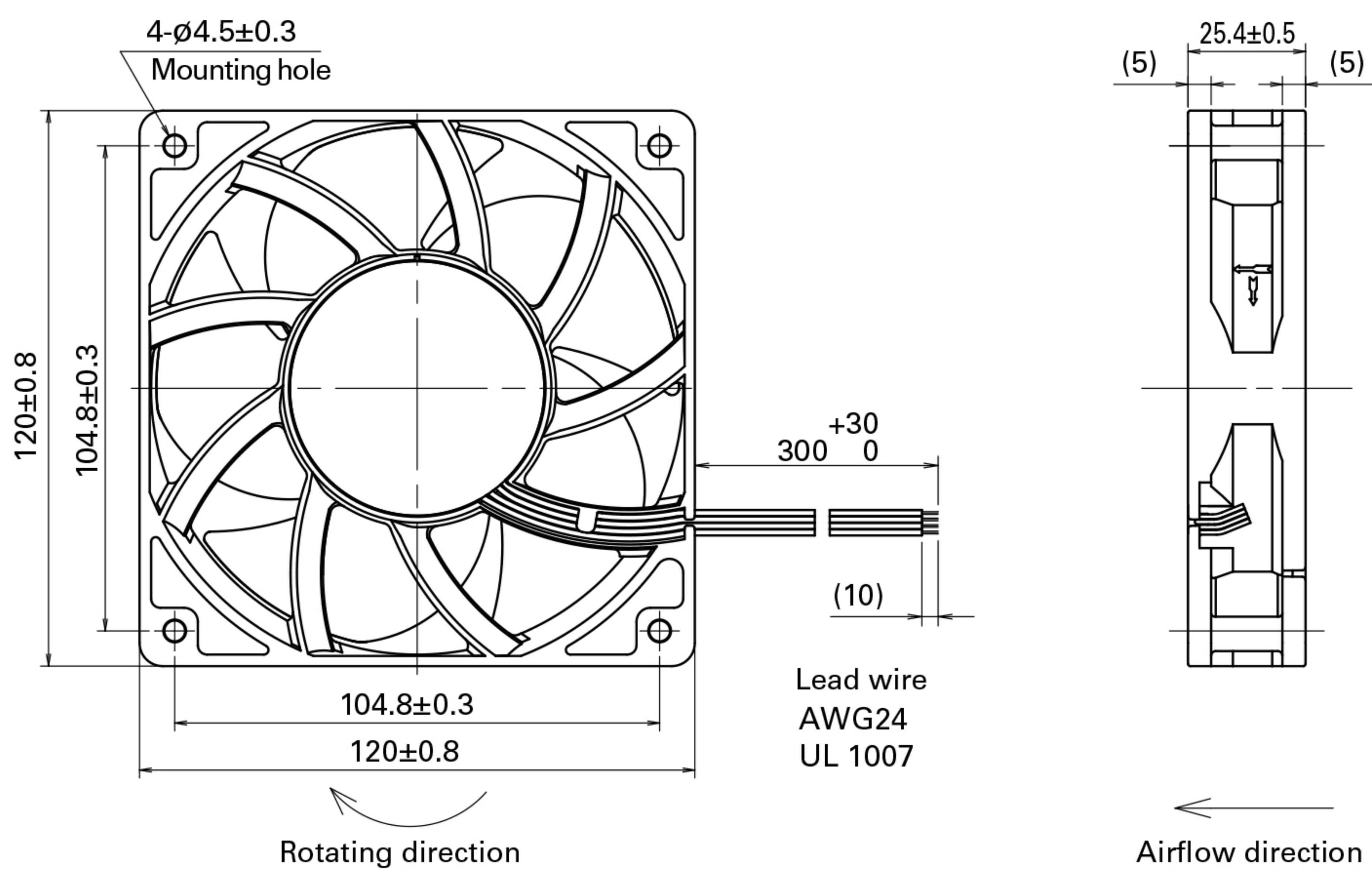

Reference Dimensions of Mounting Holes and Vent Opening (unit: mm)

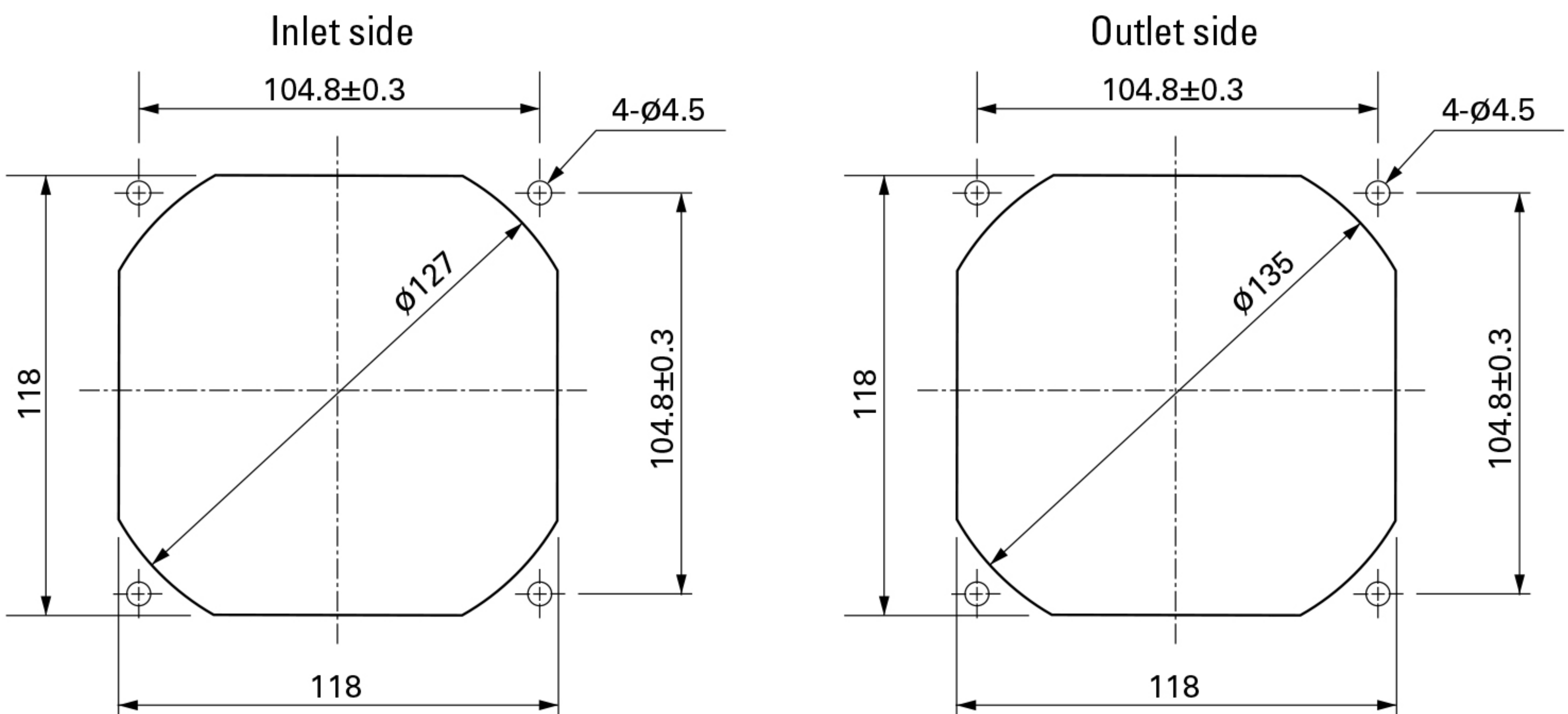

Options

Finger guards page: p. 533
Model no.: 109-019E, 109-019K, 109-019C, 109-019H

Resin finger guards page: p. 539
Model no.: 109-1000G

Resin filter kits page: p. 540
Model no.: 109-1000F13 (13PPI), 109-1000F20 (20PPI),
109-1000F30 (30PPI), 109-1000F40 (40PPI)