

# 80x80x25 mm

**San Ace 80 9R type**    Model 109R0812E401 is not certified.



## General Specifications

- Material ..... Frame: Plastic (Flammability: UL 94V-0), Impeller: Plastic (Flammability: UL 94V-1)
- Expected life ..... See the table below. (L10 life: 90% survival rate for continuous operation in free air at 60°C, rated voltage)
- Motor protection function ..... Locked rotor burnout protection, Reverse polarity protection  
For details, please refer to p. 547.
- Dielectric strength ..... 50/60 Hz, 500 VAC, for 1 minute (between lead wire conductors and frame)
- Insulation resistance ..... 10 MΩ or more with a 500 VDC megger (between lead wire conductors and frame)
- Sound pressure level (SPL) ..... At 1 m away from the air inlet
- Storage temperature ..... -30 to +70°C (Non-condensing)
- Lead wire ..... ⊕Red ⊖Black or Blue Sensor Yellow
- Mass ..... 110 g

## Specifications

The models listed below **have ribs and pulse sensors**. For models without ribs, append "1" to the end of model numbers.

Model no.	Rated voltage [V]	Operating voltage range [V]	Rated current [A]	Rated input [W]	Rated speed [min <sup>-1</sup> ]	Max. airflow [m <sup>3</sup> /min] [CFM]	Max. static pressure [Pa] [inchH <sub>2</sub> O]	SPL [dB (A)]	Operating temperature [°C]	Expected life [h]
<b>109R0805F401</b>	5	4.5 to 5.5	0.25	1.25	2600	0.92 32.5	28.4 0.114	26	-20 to +70	60000/60°C
<b>109R0805M401</b>			0.17	0.85	2350	0.83 29.3	22.5 0.09	23		
<b>109R0812G401</b>	12	10.8 to 13.2	0.37	4.44	4500	1.5 53.0	80.4 0.323	40	-20 to +60	40000/60°C
<b>109R0812E401</b>			0.24	2.88	3700	1.31 46.3	57.8 0.232	35		
<b>109R0812S401</b>		6 to 13.8	0.18	2.16	3400	1.2 42.4	48.0 0.193	34	-20 to +70	60000/60°C
<b>109R0812H401</b>			0.13	1.56	2900	1.03 36.4	35.3 0.142	29		
<b>109R0812F401</b>			0.11	1.32	2600	0.92 32.5	28.4 0.114	26		
<b>109R0812M401</b>			0.09	1.08	2350	0.83 29.3	22.5 0.09	23		
<b>109R0812L401</b>		7 to 13.8	0.06	0.72	1850	0.65 23.0	14.7 0.059	20		
<b>109R0824G401</b>		24	20.4 to 26.4	0.2	4.8	4500	1.5 53.0	80.4 0.323	40	-20 to +60
<b>109R0824S401</b>	12 to 27.6		0.1	2.4	3400	1.2 42.4	48.0 0.193	34	-20 to +70	60000/60°C
<b>109R0824H401</b>			0.07	1.68	2900	1.03 36.4	35.3 0.142	29		
<b>109R0824F401</b>			0.06	1.44	2600	0.92 32.5	28.4 0.114	26		
<b>109R0824M401</b>			0.05	1.2	2350	0.83 29.3	22.5 0.09	23		
<b>109R0824L401</b>	14 to 27.6		0.04	0.96	1850	0.65 23.0	14.7 0.059	20		
<b>109R0848K401</b>	48	40.8 to 55.2	0.1	4.8	4600	1.56 55.1	88.4 0.355	41	-20 to +60	40000/60°C
<b>109R0848S401</b>			0.06	2.88	3400	1.2 42.4	48.0 0.193	34	-20 to +70	60000/60°C

The following sensor and control options are available for selection.

Differs according to the model. Refer to the table on pp. 564 to 565. Without sensor Lock sensor

## Airflow - Static Pressure Characteristics

**109R0805F401** With pulse sensor

Operating voltage range

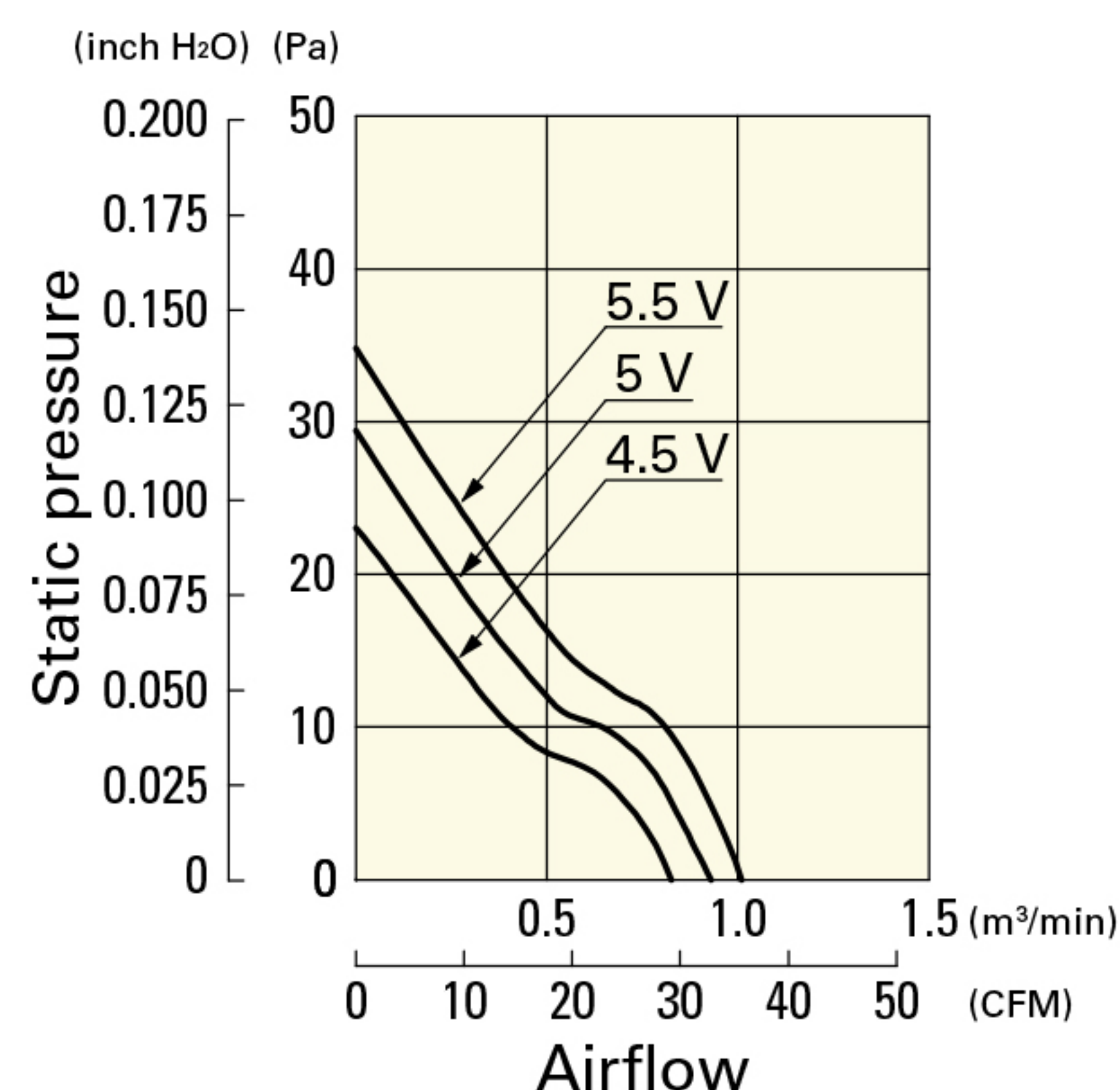

**109R0805M401** With pulse sensor

Operating voltage range

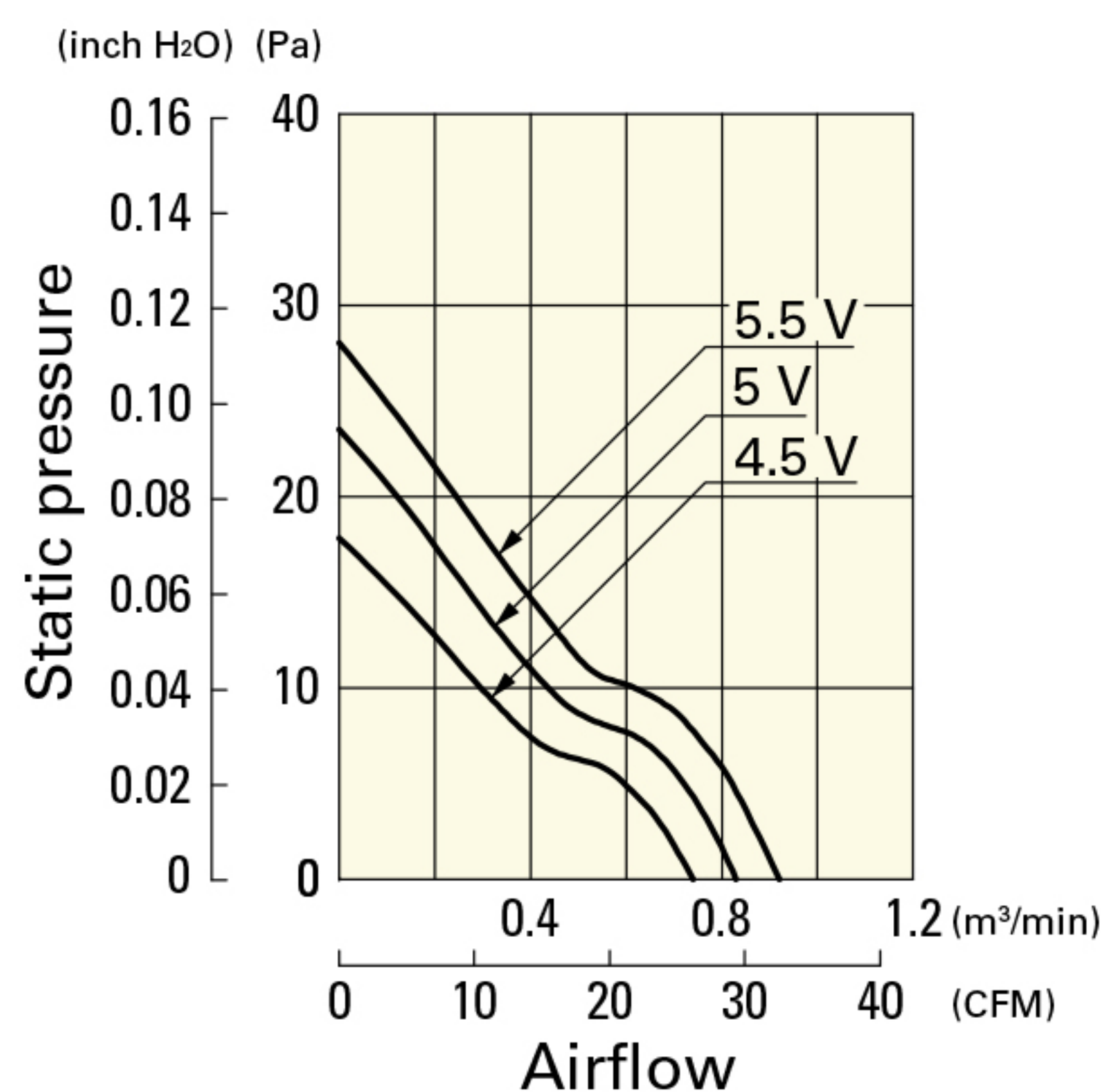

**109R0812G401** With pulse sensor

Operating voltage range

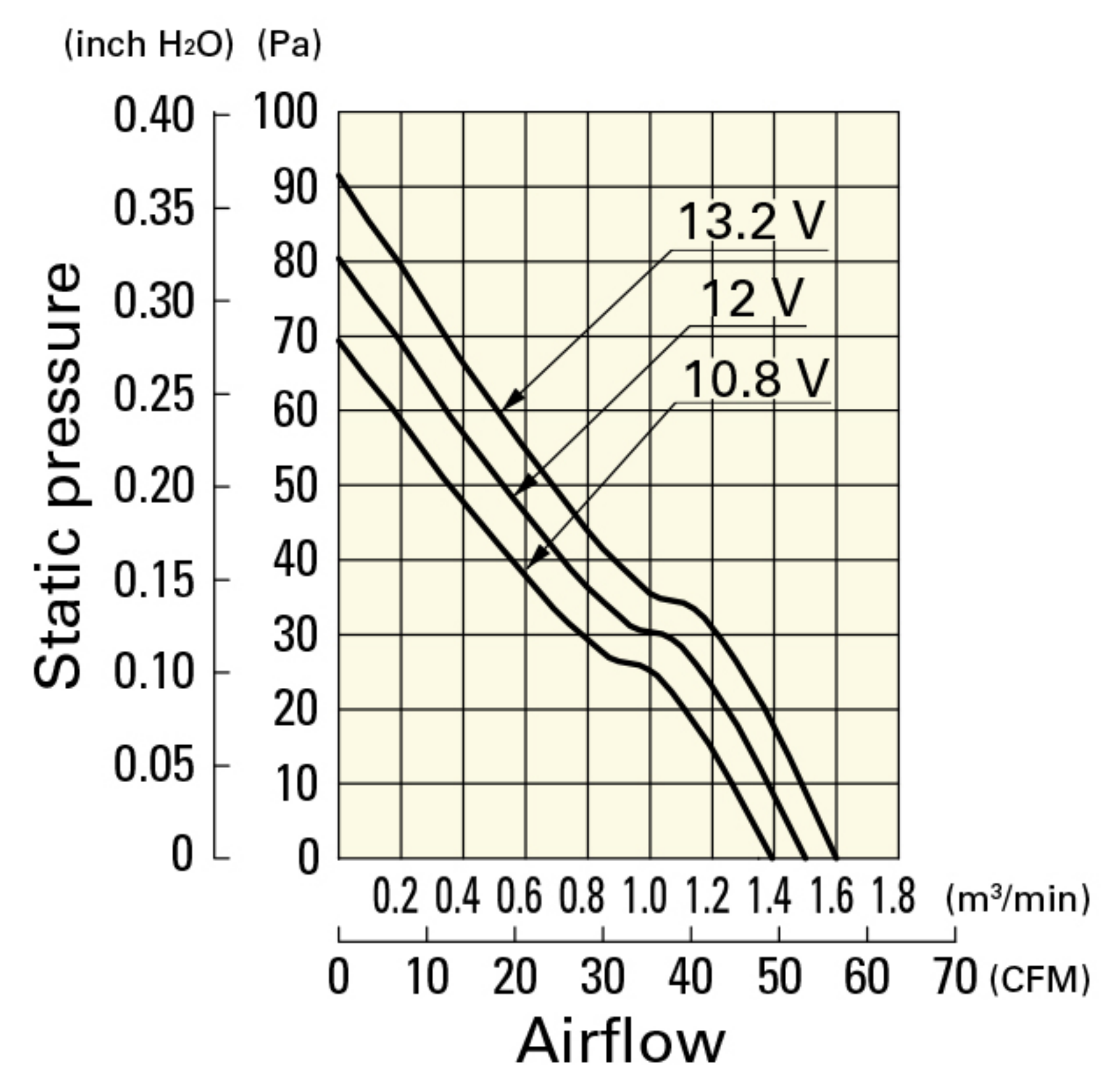

# Airflow - Static Pressure Characteristics

**109R0812E401** With pulse sensor

Operating voltage range

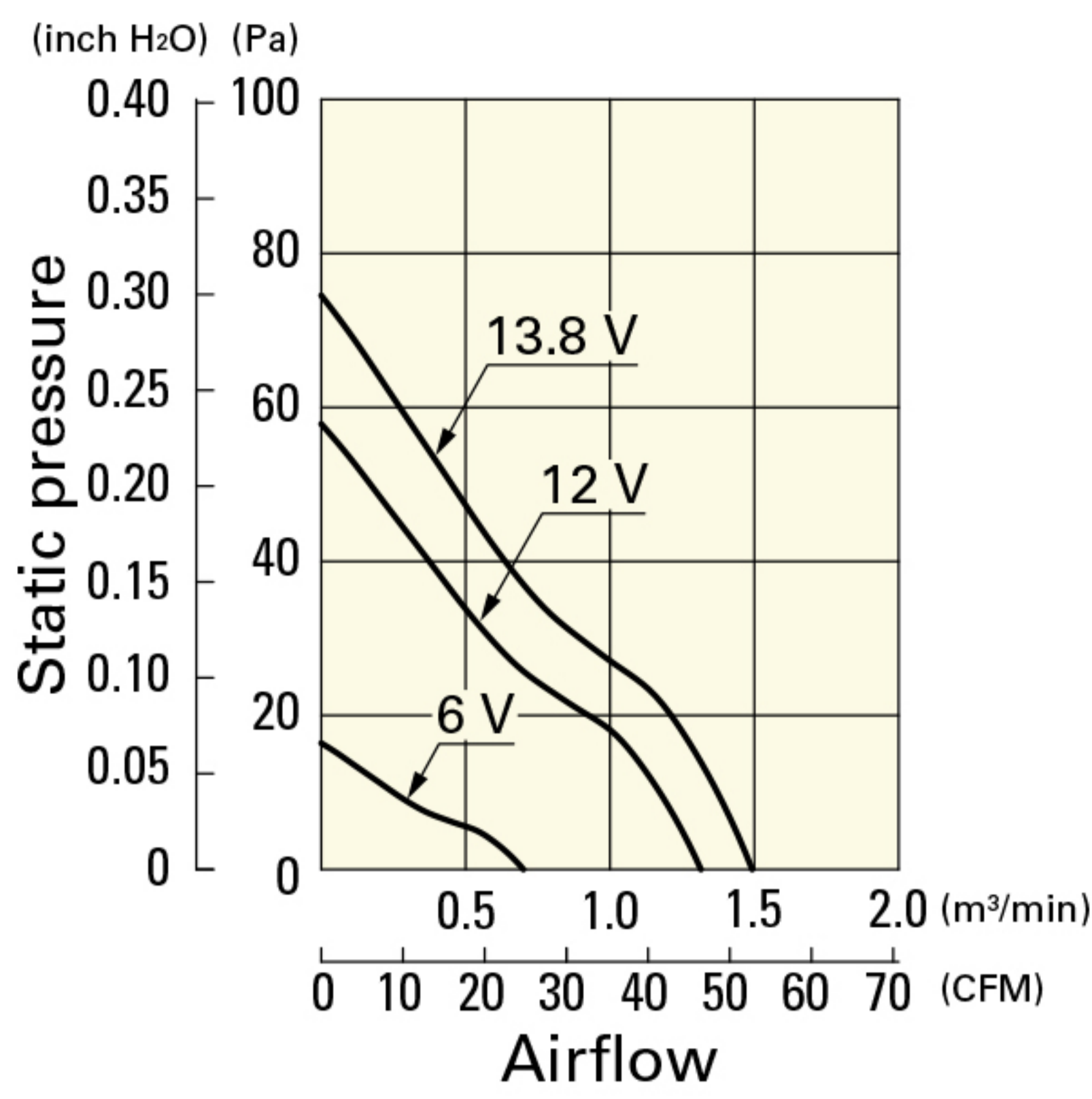

**109R0812S401** With pulse sensor

Operating voltage range

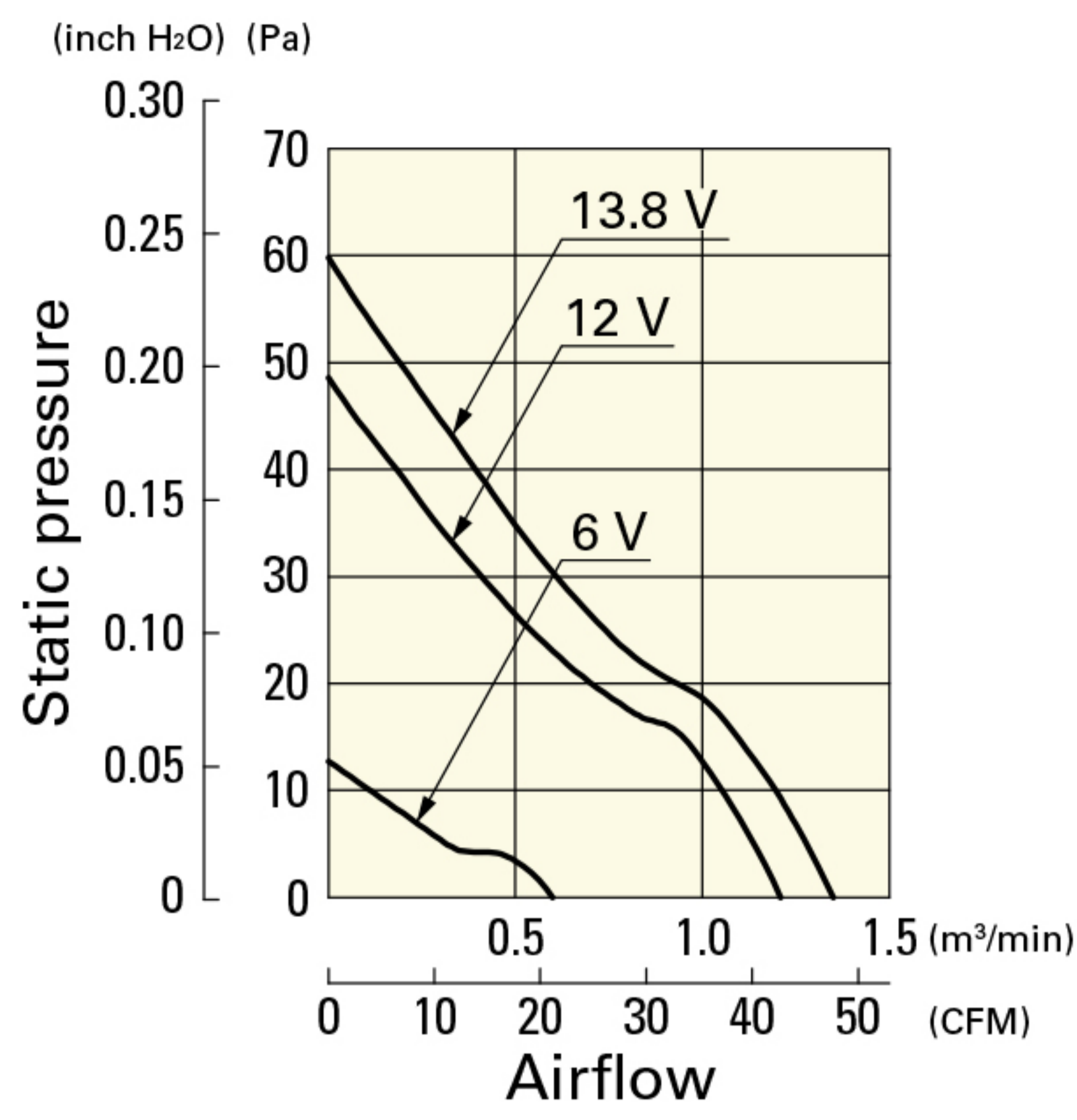

**109R0812H401** With pulse sensor

Operating voltage range

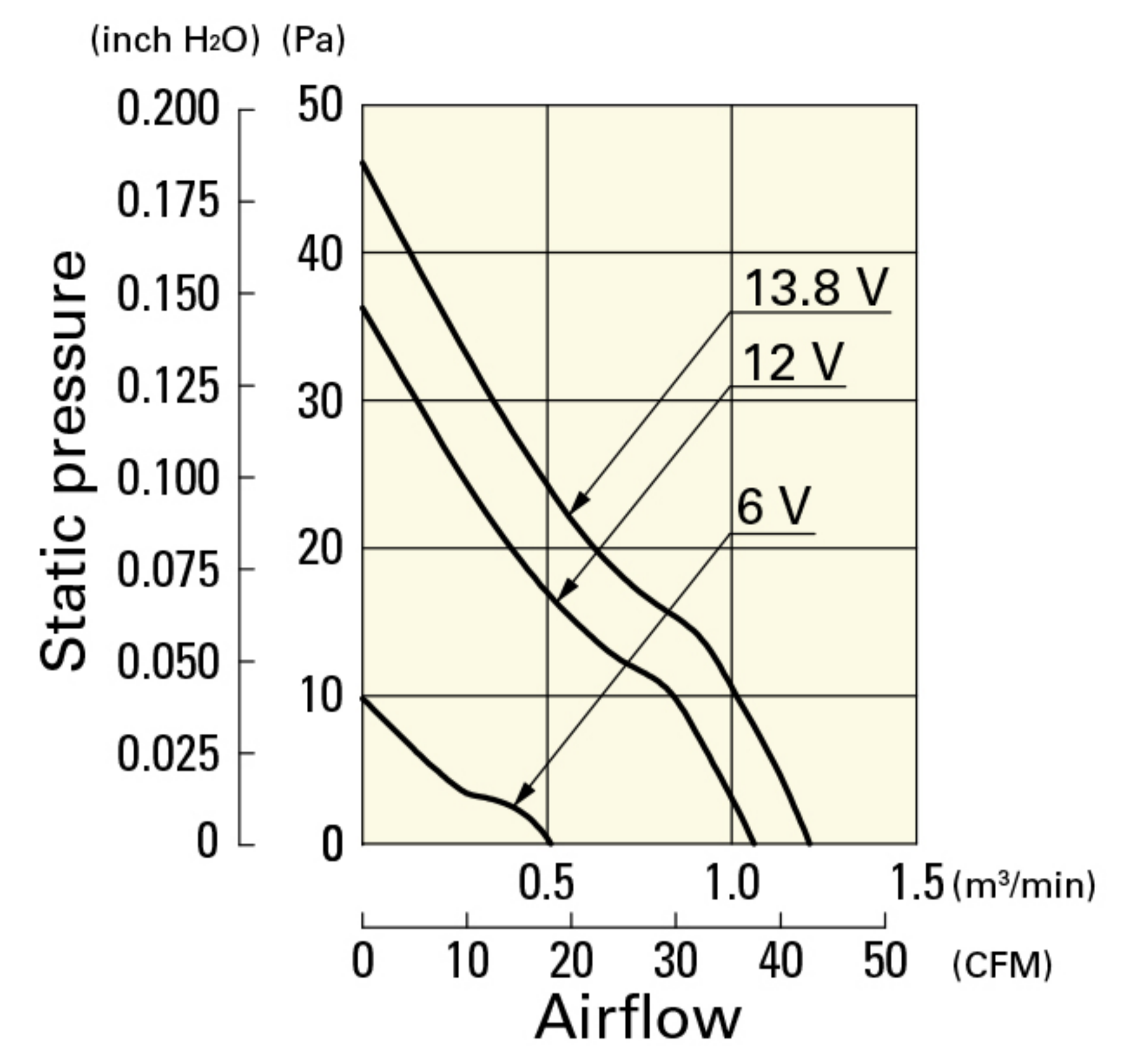

**109R0812F401** With pulse sensor

Operating voltage range

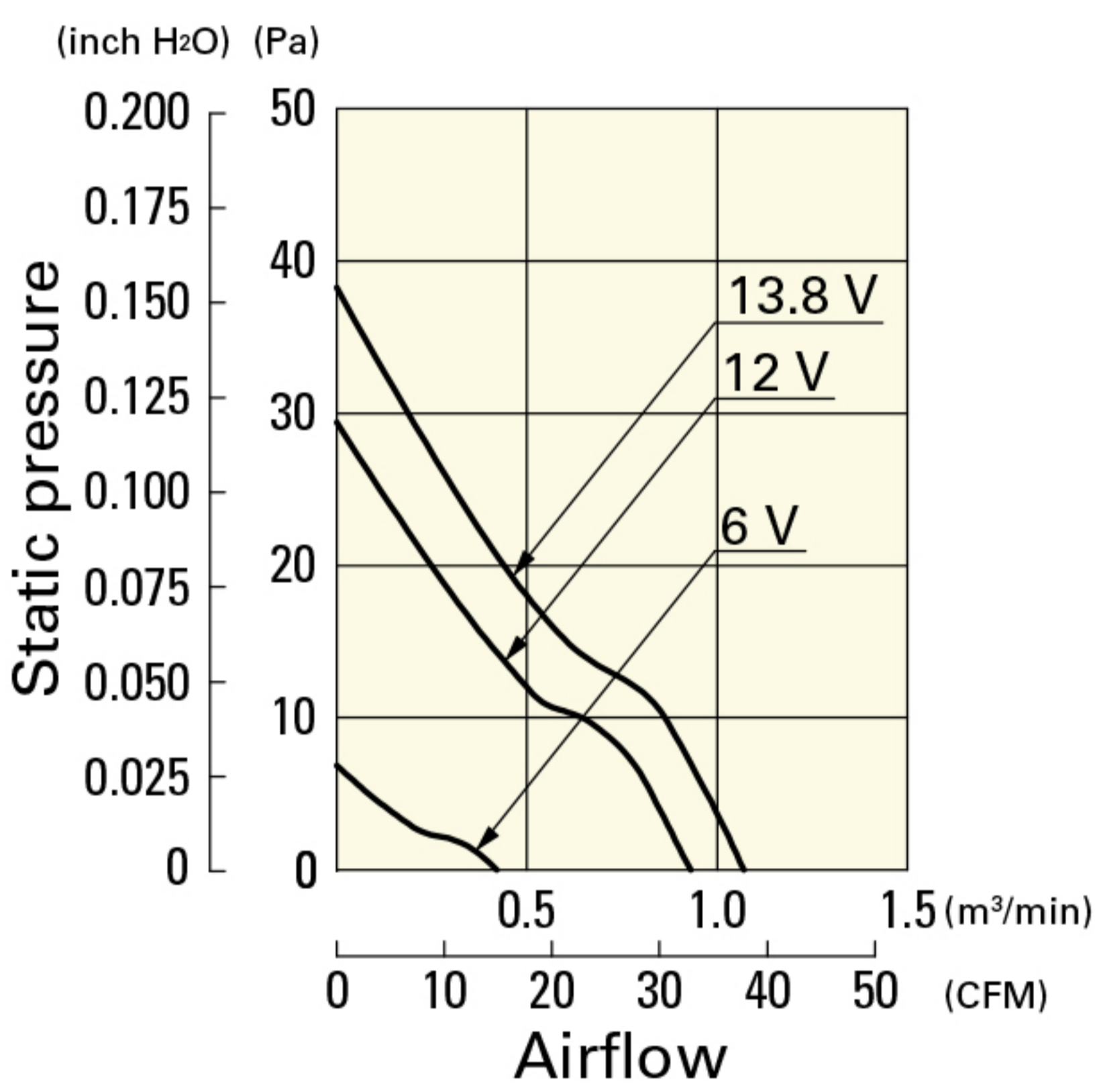

**109R0812M401** With pulse sensor

Operating voltage range

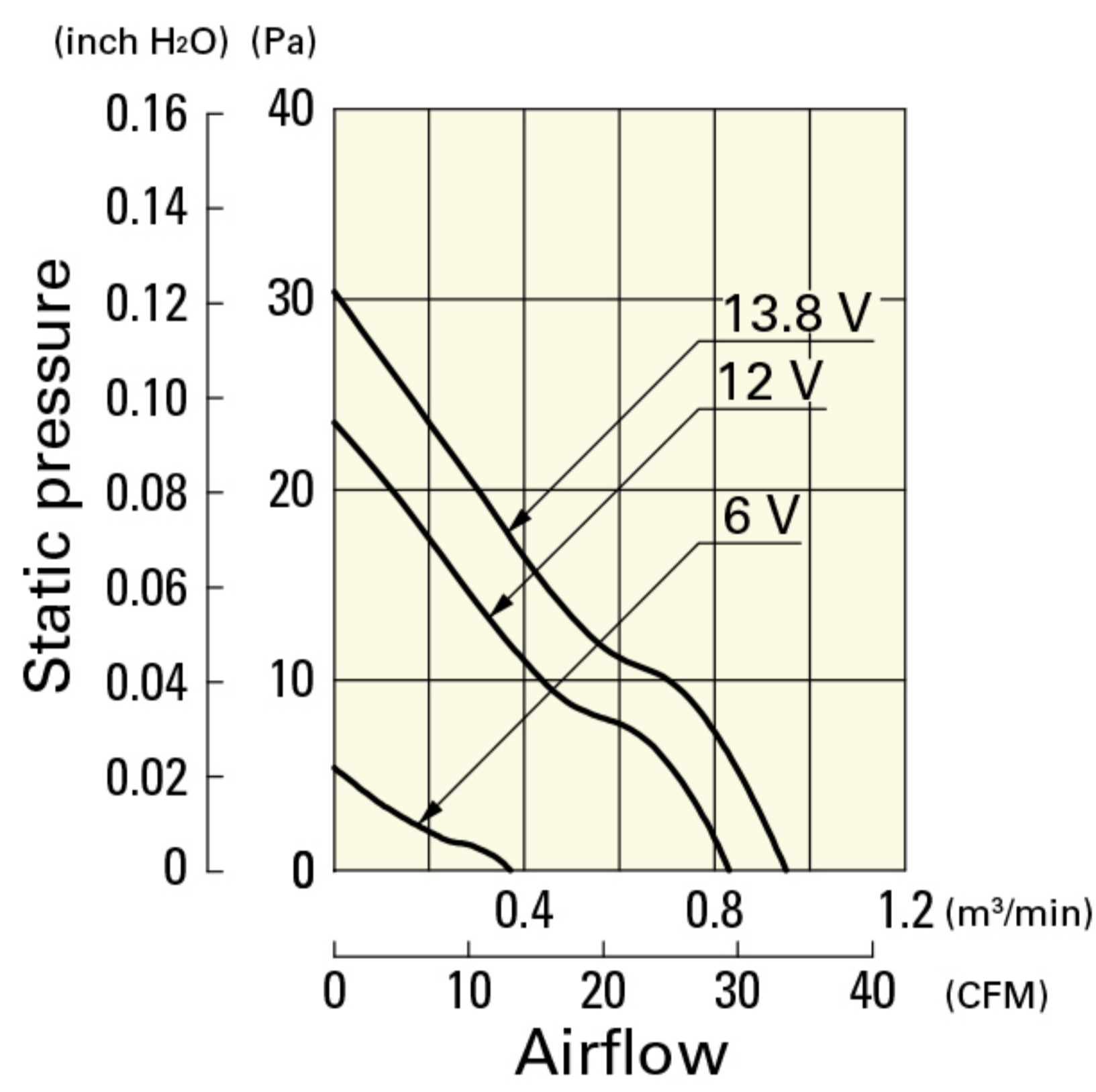

**109R0812L401** With pulse sensor

Operating voltage range

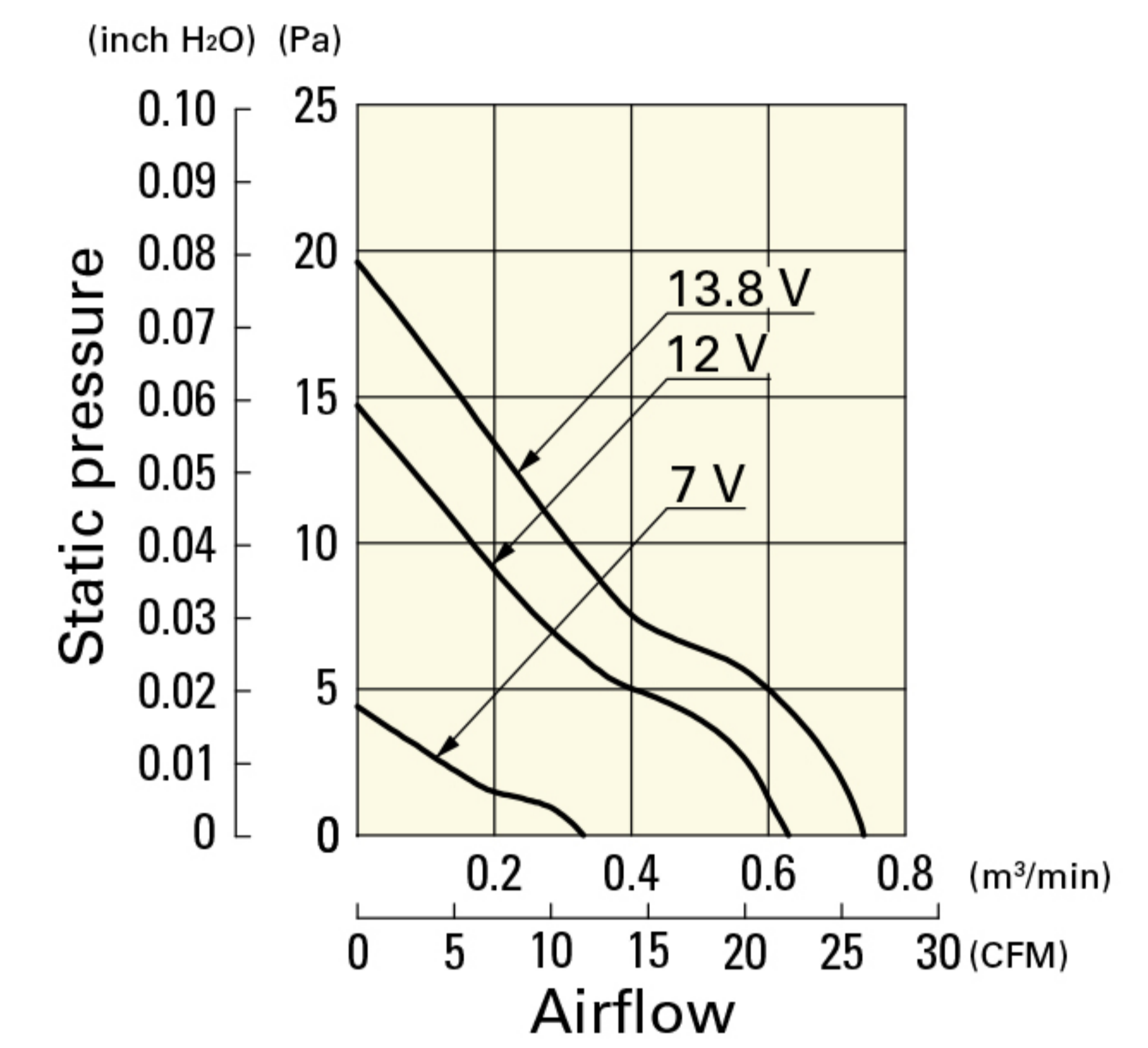

**109R0824G401** With pulse sensor

Operating voltage range

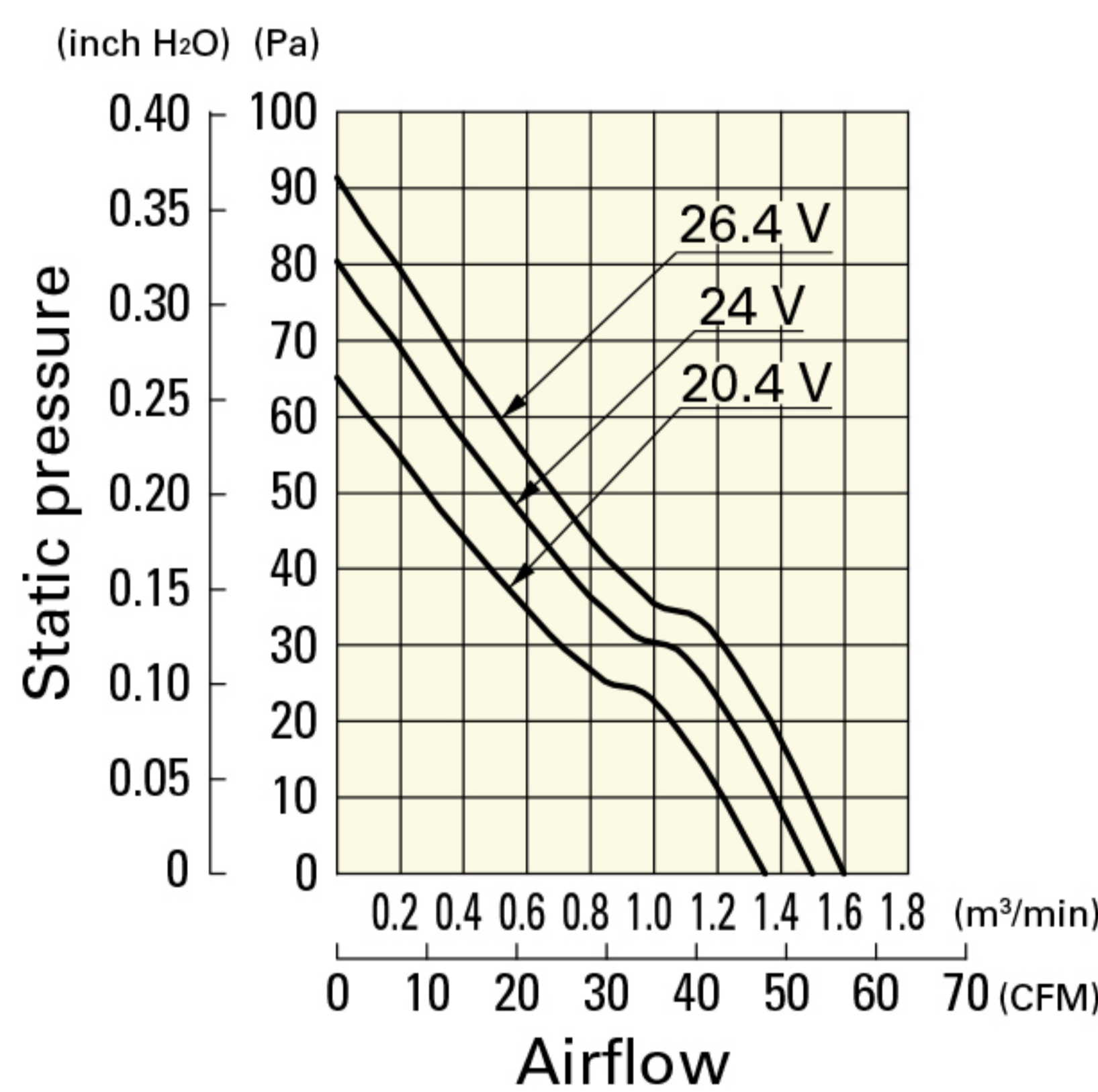

**109R0824S401** With pulse sensor

Operating voltage range

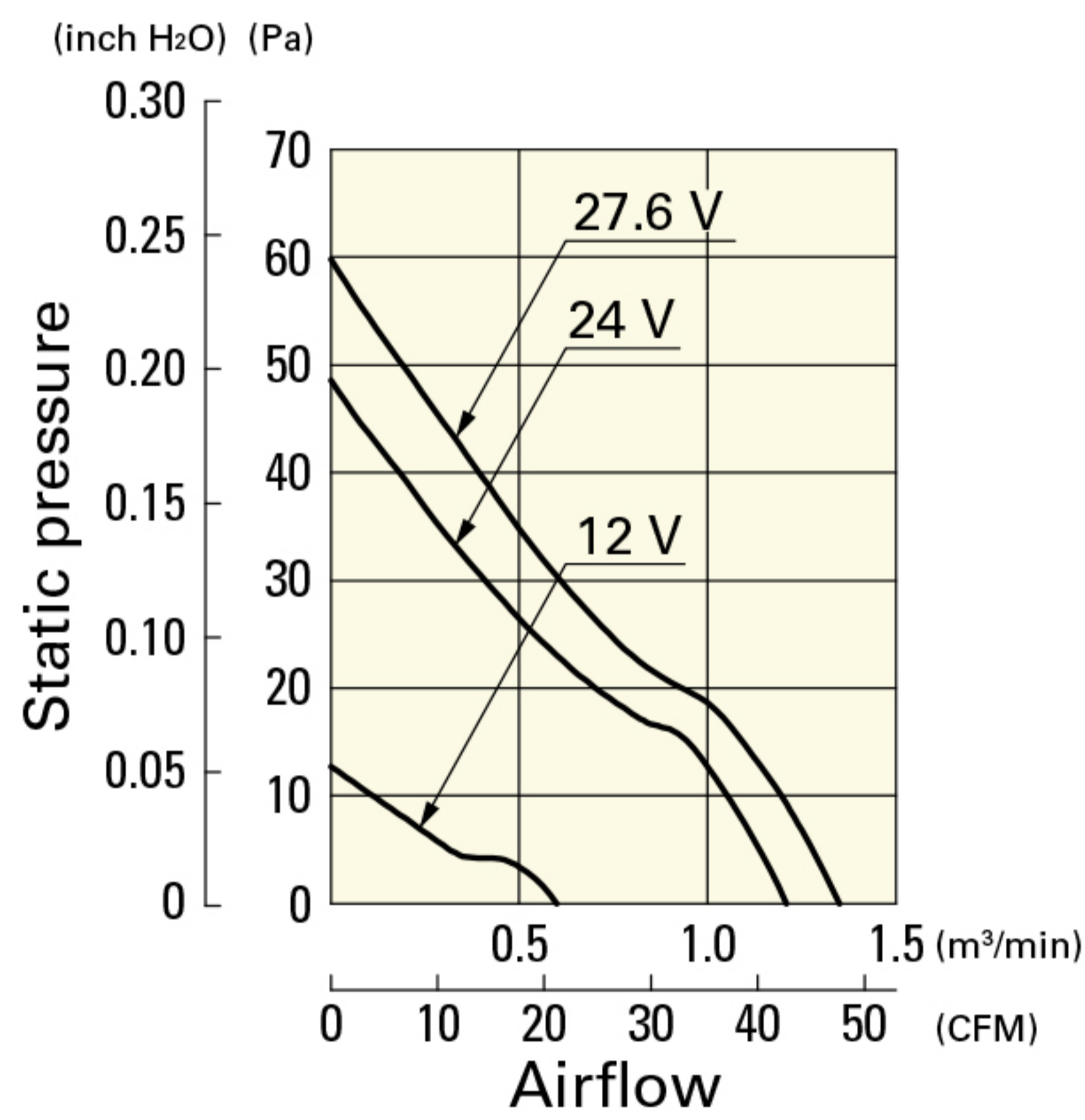

**109R0824H401** With pulse sensor

Operating voltage range

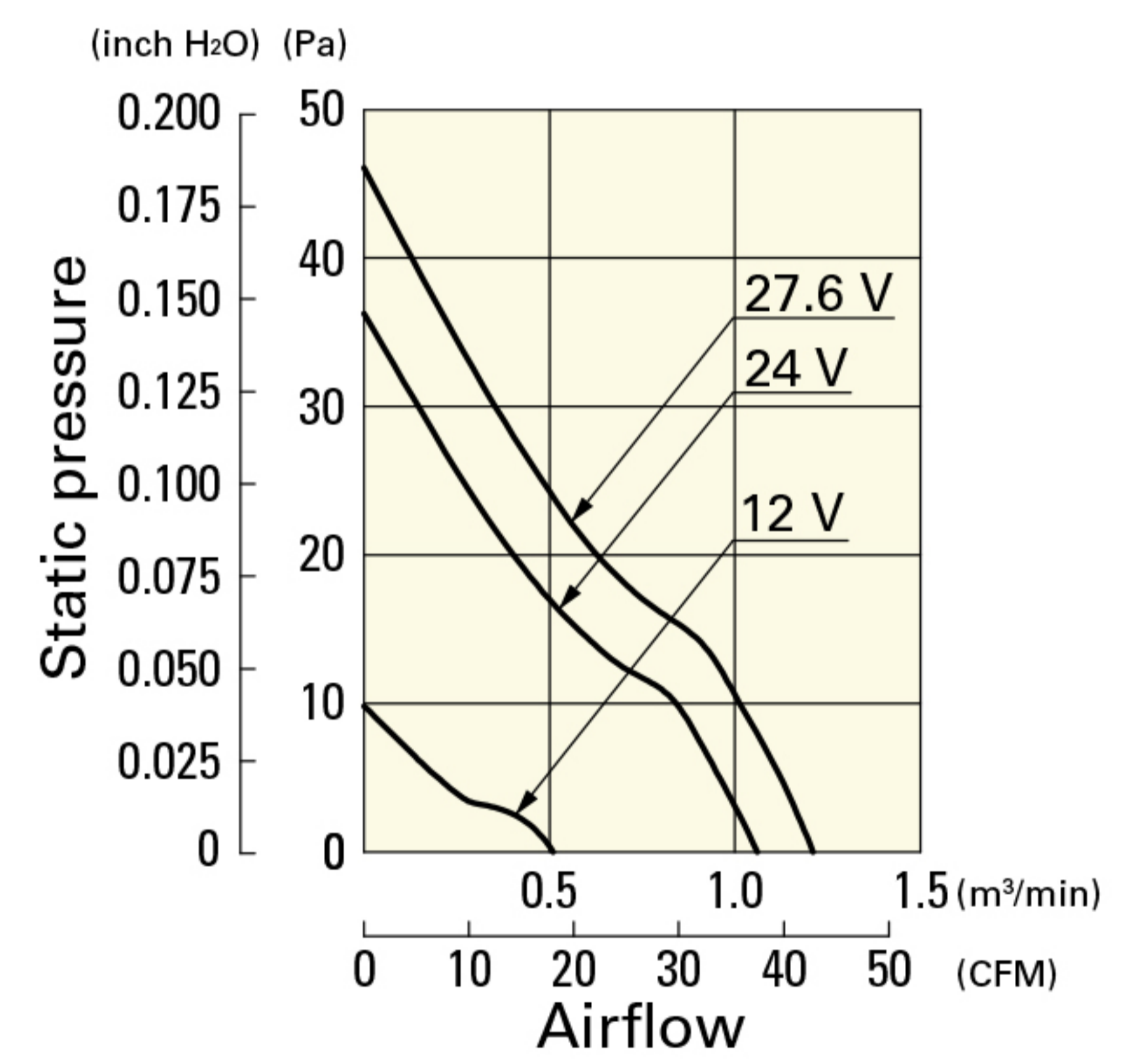

**109R0824F401** With pulse sensor

Operating voltage range

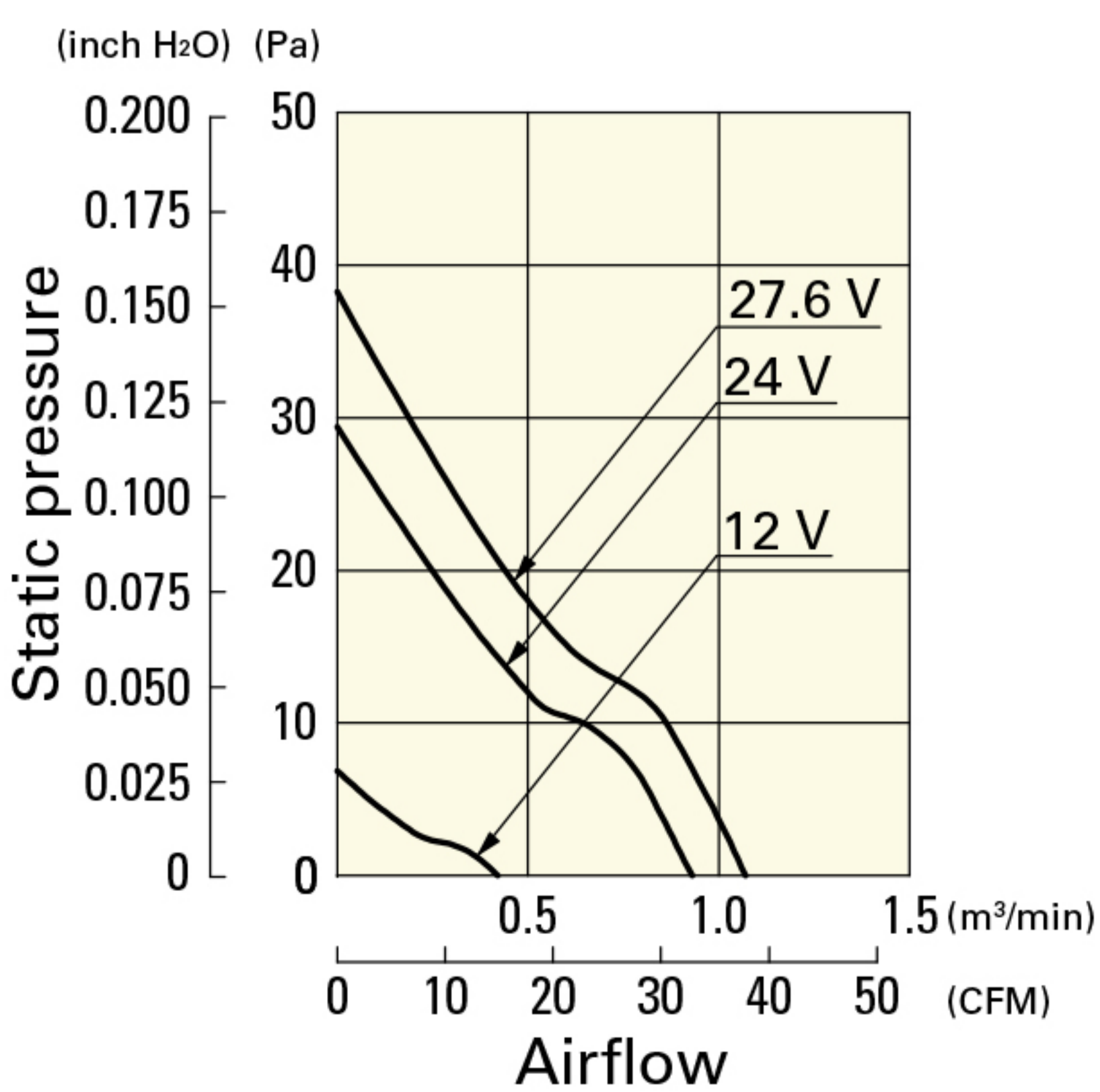

**109R0824M401** With pulse sensor

Operating voltage range

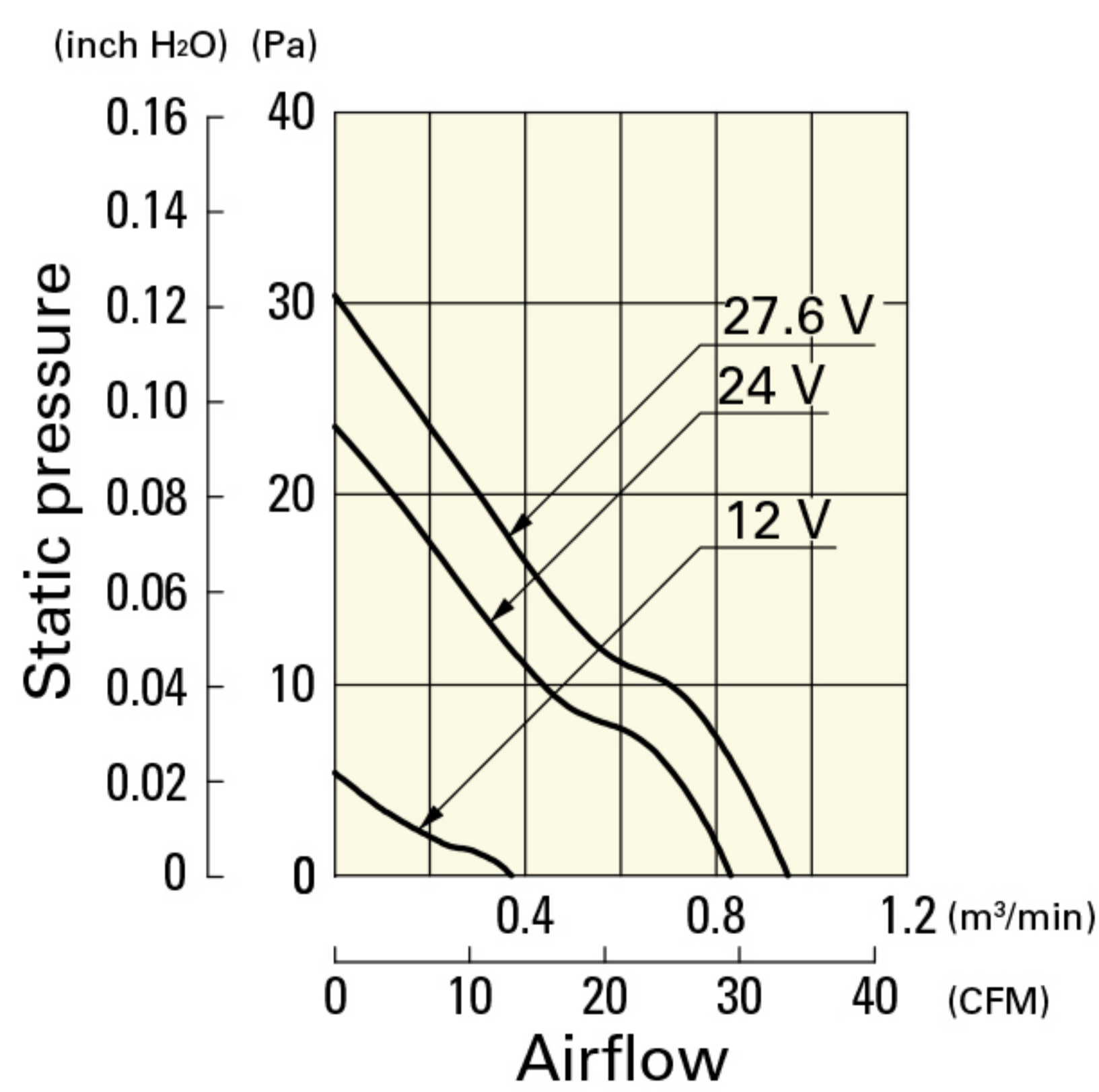

**109R0824L401** With pulse sensor

Operating voltage range

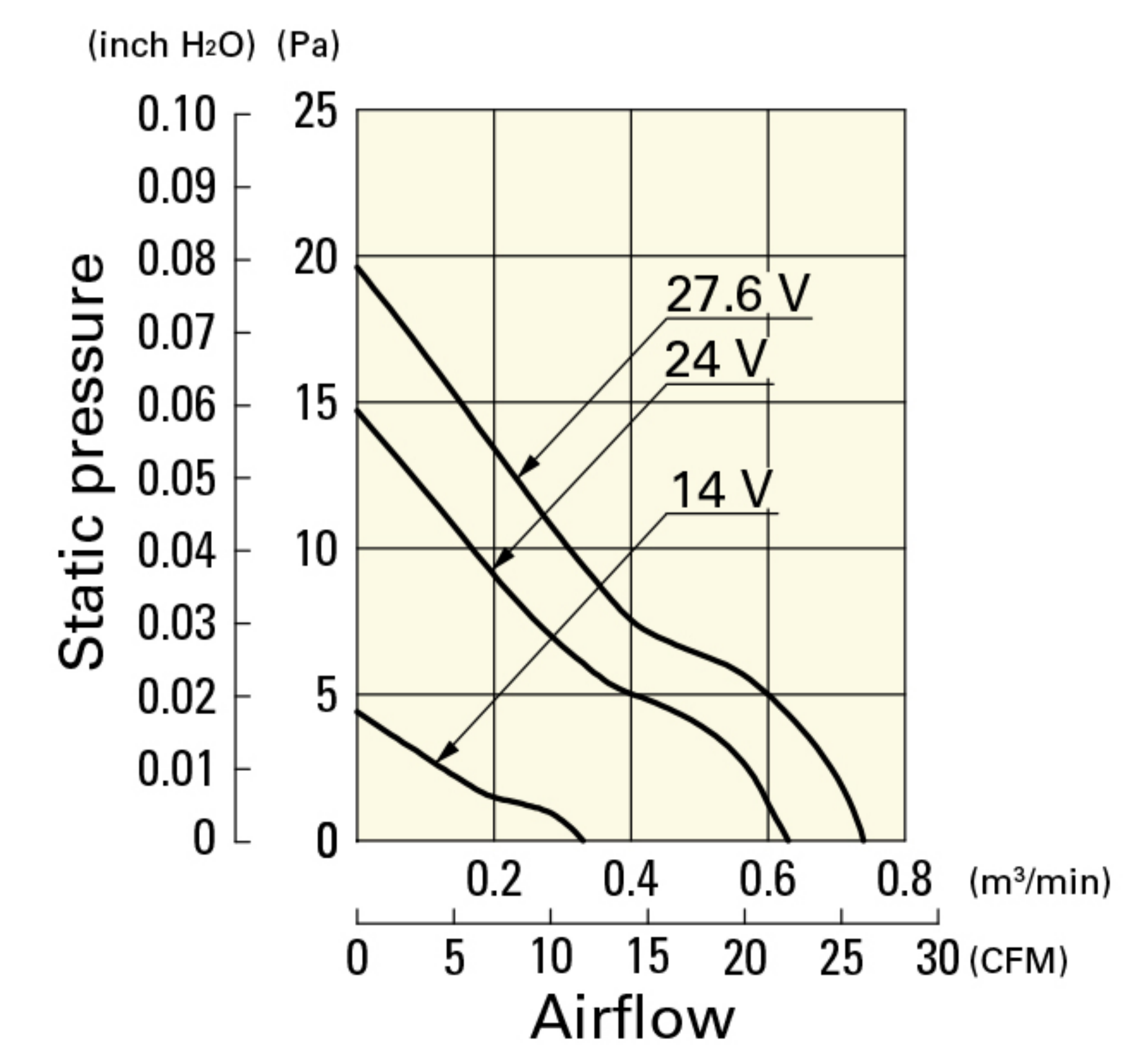

# Airflow - Static Pressure Characteristics

## 109R0848K401 With pulse sensor

## 109R0848S401 With pulse sensor

Operating voltage range

Operating voltage range

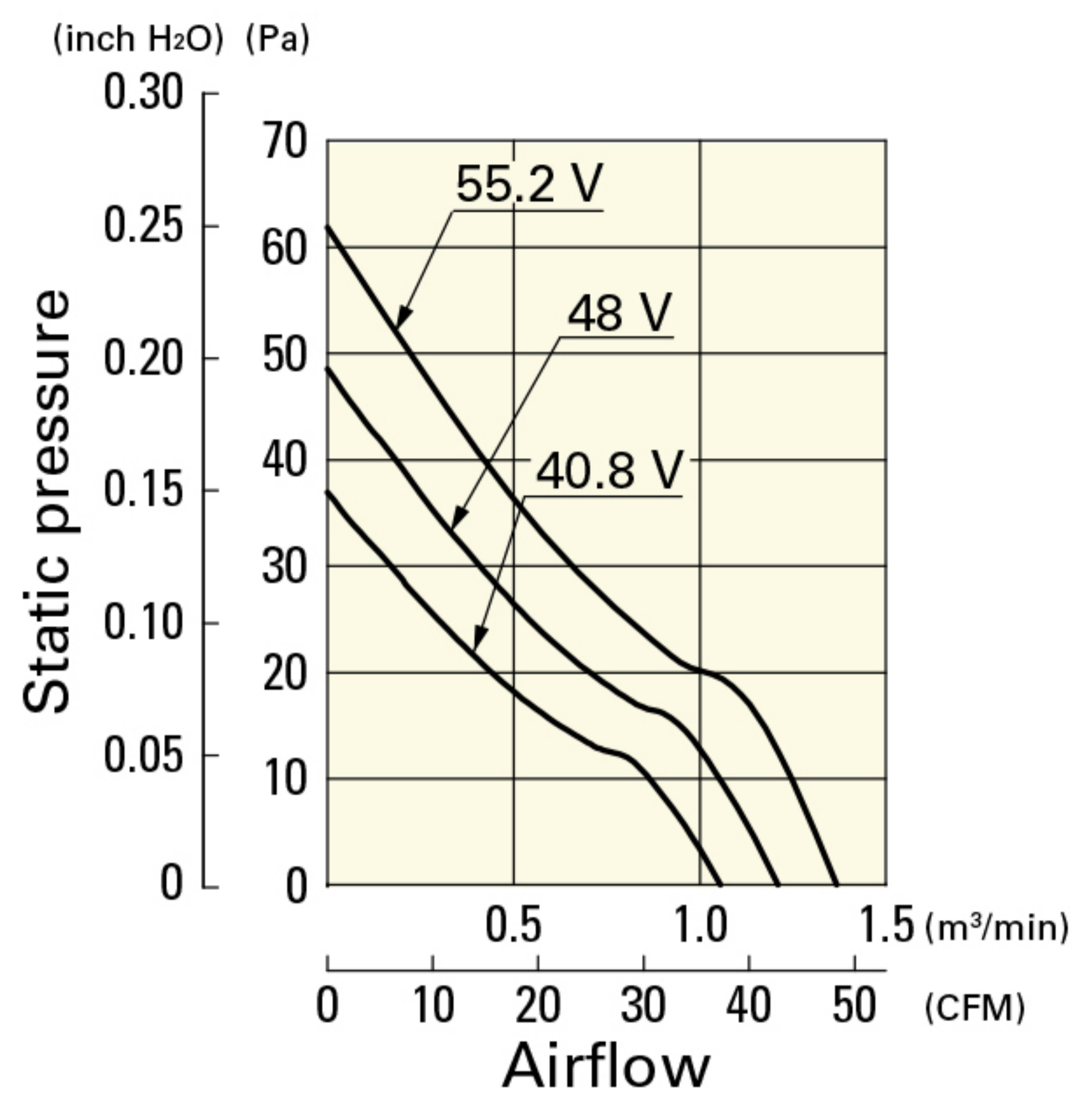
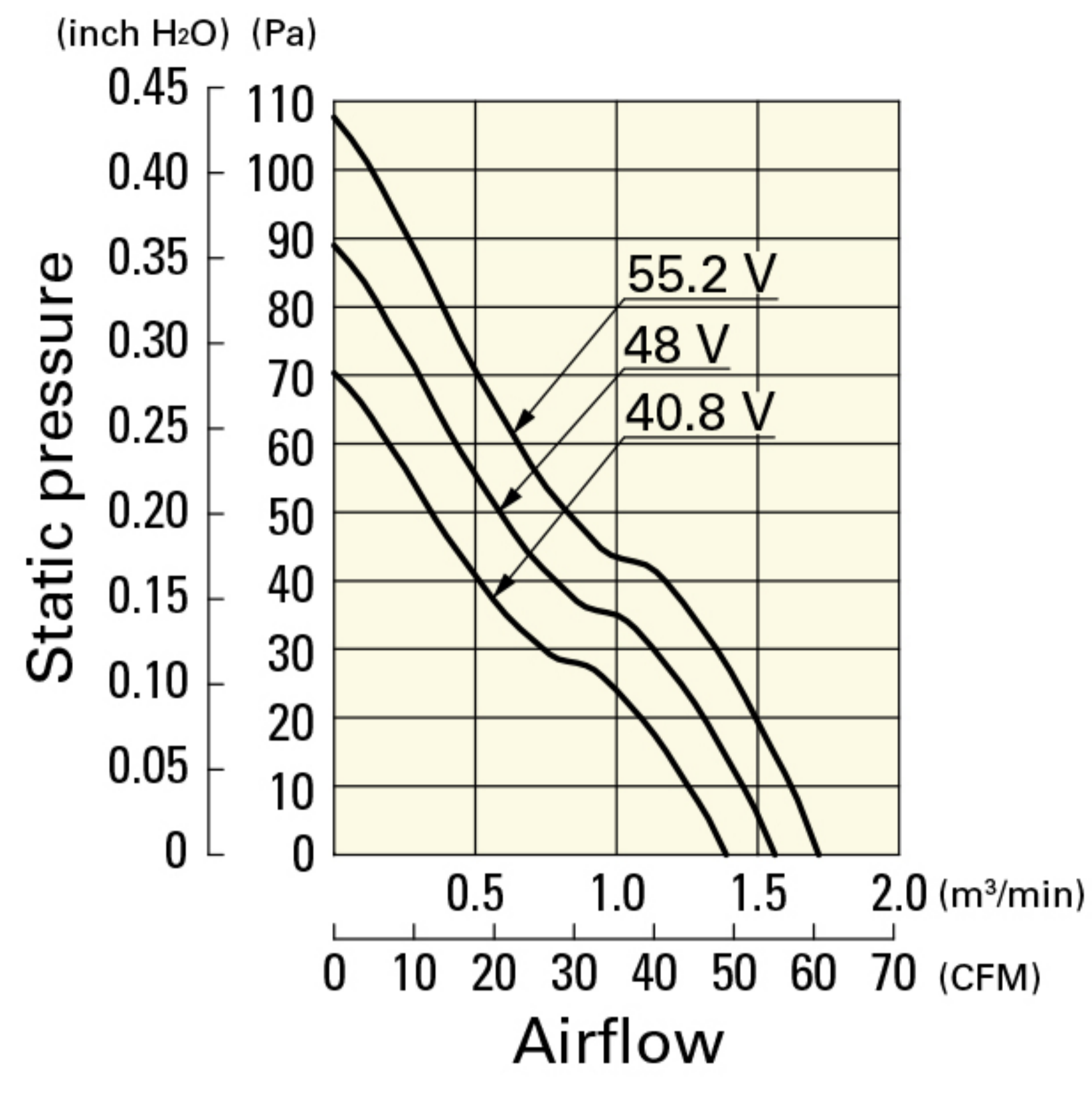

## Dimensions (unit: mm) (With ribs)

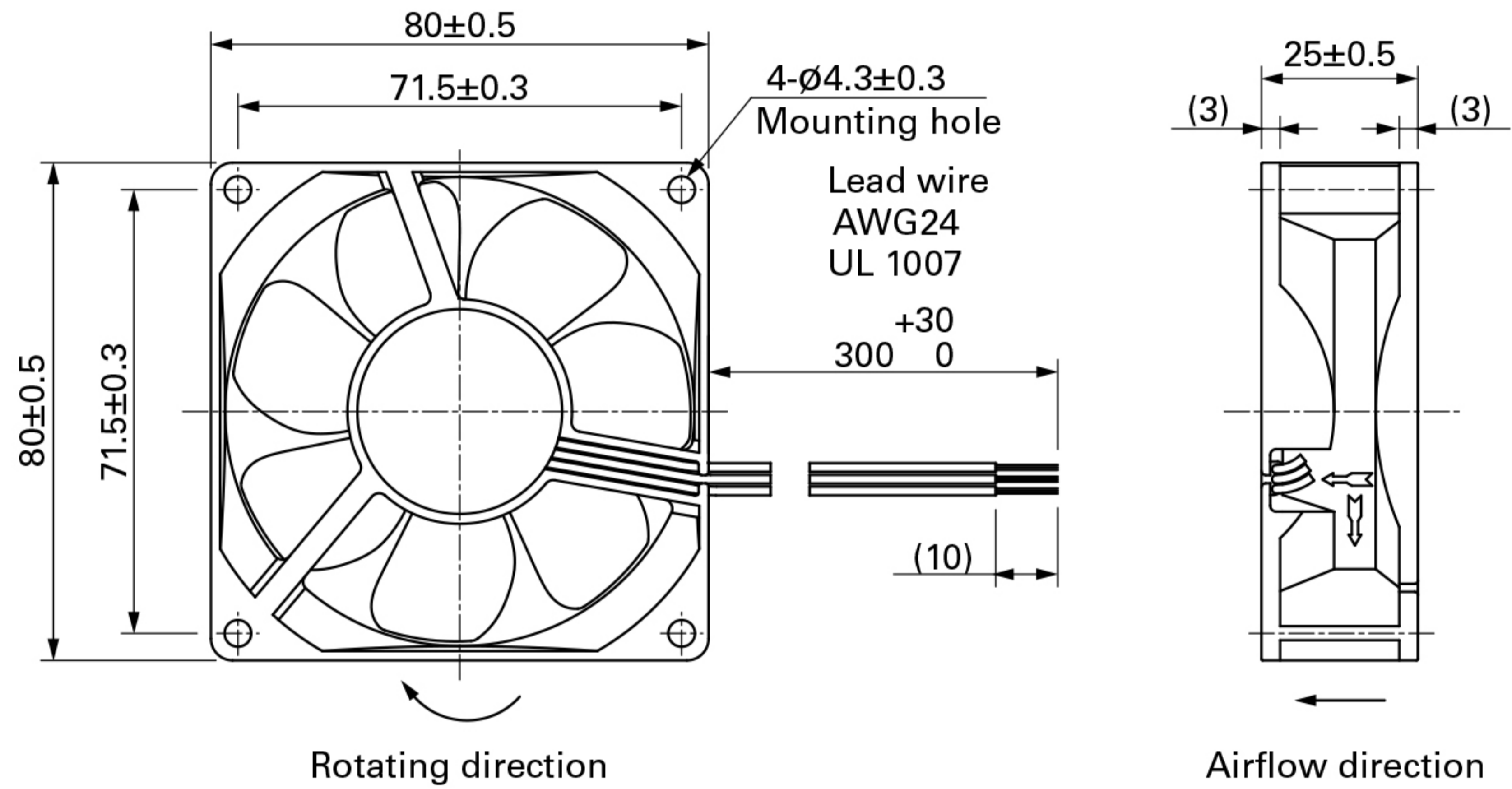

## Reference Dimensions of Mounting Holes and Vent Opening (unit: mm)

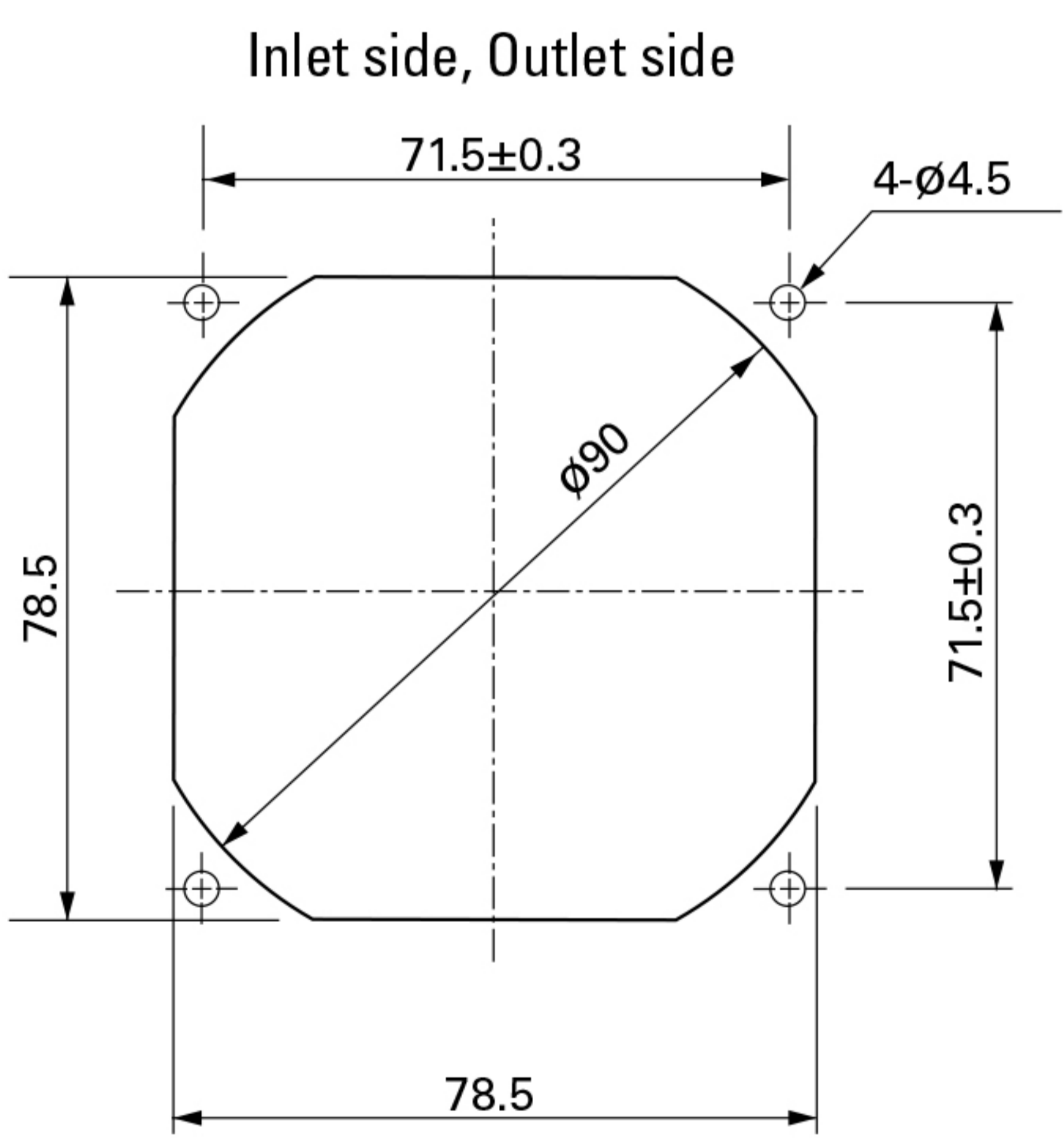

## Options

Finger guards page: p. 532  
Model no.: 109-049E, 109-049H, 109-049C

Resin finger guards page: p. 539  
Model no.: 109-1002G

Resin filter kits page: p. 540  
Model no.: 109-1002F13 (13PPI), 109-1002F20 (20PPI), 109-1002F30 (30PPI), 109-1002F40 (40PPI)