

产 品 规 格 书

Product specification

名 称(NAME): 后倾式离心风机 Backward curved centrifugal fan

型 号(MODEL): R25092N-23W-B7T

客户代码(CUSTOMER CODE): D000

版本号(VERSION NUMBER): A/0

编 制 (Prepared): 陈经纬 2015/11/25

校 对 (Checked): 吴化新 2015.11.25

审 核 (Reviewed): 黄坤河 2015.11.28

批 准 (Approved): 尚毅 2015/11/28

客户确认 (CUSTOMER'S APPROVAL):

日 期(DATE): 2015.11.28

换版记录 Description of Revision

版本号 Version No.	换版原因 Notes & Remarks	换版内容 reason content	修订人 Revised by	日期 Date
A/0	/	/	/	/

1. 适用范围 SCOPE

本电动机规格书适用于3相直流无刷电动机的技术规定
 其中没有特别指明处均遵从中国国家强制性产品认证和CE认证，且满足欧盟ErP要求
 THIS SPECIFICATION IS SPECIFIED FOR 3-PHASE DC BRUSHLESS MOTOR.
 ITEMS EXCEPT HAVING INDICATED IN THE SPECIFICATION, ARE APPLIED TO CHINA COMPULSORY PRODUCT CERTIFICATION AND CE,
 AND TO MEET THE EU ErP REQUIREMENTS.

2. 规格 SPECIFICATIONS

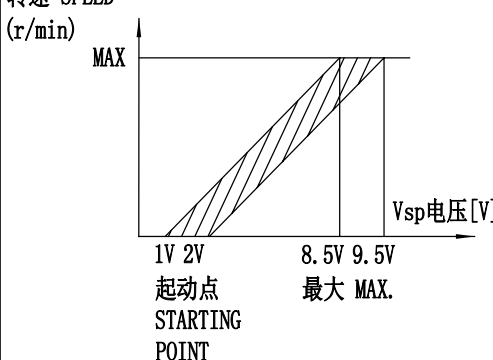
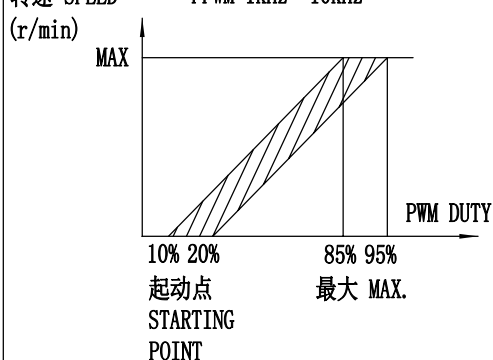
项目 ITEM	内容 SPECIFICATION	备注 DESCRIPTION	
电气特性 ELECTRICAL CHARACTERISTICS	电压VOLTAGE	AC220 [V]	范围：AC200-277V RANGE
	频率FREQUENCY	50 [Hz]	范围：50/60Hz RANGE
	转速SPEED	3100±10% [r/min]	
	功率POWER	165±16% [W]	
	电流 CURRENT	1.15±16% [A]	
	最大风量 AIR FLOW	1480MAX. [m³/h]	
	噪音 NOISE	72±6 [dBA]	
	泄漏电流 LEAKAGE CURRENT	3.5 MAX. [mA]	测试条件 AC1500V 1S TESTING CONDITIONS
	绝缘等级 INSULATION CLASS	B 级 CLASS	
	控制方式 CONTROL INPUT	0-10V Vdc/PWM	见图一、二 SEE FIG. 1、 2
	输出电源 OUTPUT	+10Vdc	
	转速信号 TACH OUTPUT	1PULSE/R	占空比 DUTY 30%~70% 须在+10V与TACH OUTPUT间连接10KΩ上 拉电阻/IT NEEDS 10KΩ PULL-UP RESISTANCE BETWEEN +10V LINE AND TACH OUTPUT LINE
	保护方式： PROTECTED MODE	过温/过流/堵转保护 OVER-TEMPERATURE/OVER-CURRENT/LOCKED PROTECTED	
转速 SPEED (r/min) 		转速 SPEED (r/min) FPWM=1kHz~10kHz 	

机械特性 MECHANICAL SPECIFICATION	外观 APPEARANCE	不能有影响商品质量的伤痕和污迹 THERE SHOULD NOT BE ANY DEFECTS AND DIRTY WHICH SPOIL GOODS VALUE	
	质量 MASS	约 APPROX 2.4[Kg]	
	电机引线引拔强度 LEAD WIRE PULLED OUT STRENGTH	20 [N/根]以上 MIN.	
	寿命 LIFE	20000 [h]MIN	额定负载3100[r/min] 轴承温度70[°C]以下连续运转 RATED LOAD 3100[r/min] AND THE BEARING TEMPERATURE LESS THAN 70[°C] CONTINUOUS RUNNING

3. 环境要求 ENVIRONMENTAL REQUIREMENT

保存温度 STORAGE TEMPERATURE RANGE	-25~60 [°C]	
使用·保存湿度 OPERATING, STORAGE HUMIDITY	30~95 [%]RH	无结露 NON CONDENSING
使用温度范围 OPERATING TEMPERATURE RANGE	-20~60 [°C]	
	IC散热 HEAT SINK OF IC	115[°C]以下 MAX
	其他电子部品 OTHER ELECTRONIC PARTS	85[°C]以下 MAX
	轴承 BALL BEARING	80[°C]以下 MAX
	卷线 COIL	120[°C]以下 MAX

4. 使用注意事项 NOTE IN USE

(1) 电源使用顺序如下：电源加载顺序(AC220V→V _{sp})；电源切断顺序(V _{sp} →AC220V) SERVICE SEQUENCE OF POWER SUPPLY: SEQUENCE OF POWER LOAD(AC220V→V _{sp}) SEQUENCE OF POWER DUMP(V _{sp} →AC220V)
(2) 启动时电流过大会损坏电机 请防止电流峰值超过2.5A TO PREVENT MOTOR DAMAGED BY OVER STARTING CURRENT, THE PEAK CURRENT CAN NOT EXCEED 2.5A
(3) 风机运转时不可插拔风机引线插头 PLEASE DO NOT PERFORM EXTRACTION AND INSERTION OF THE CONNECTOR UNDER REVOLUTION IRRESPECTIVE OF POWER ON AND POWER OFF
(4) 本风机通风冷却 使用时请考虑风机周边的通风条件 FAN CAN BE COOLED BY VENTILATION, PLEASE CONSIDER VENTILATED CONDITION AROUND THE FAN WHEN USING IT
(5) 轴承部不可受到冲击 DO NOT ADD SHOCK TO THE BALL BEARING
(6) 拿取风机时不可拎风机引线 引线过度受力时内部焊接部分可能脱落 DO NOT CARRY WITH LEAD WIRES WHEN HANDLE A FAN, IF ADD HUGE STRENGTH TO LEAD WIRES THAT THE SOLDERED PART IN FAN MAY BE SHED
(7) 防止冲击电压破坏风机 电源线上请不要采用继电器或其它机械开关 DO NOT USE RELAY OR OTHER MECHANICAL SWITCH ON POWER SUPPLY LINE, BECAUSE IMPACT VOLTAGE MAY DAMAGE THE FAN
(8) 按本规格书中的规格评价风机 若工作点规格需要变更 请与本公司联系 EVALUATE THE FAN REFER TO THIS SPECIFICATIONS. IF THE LOAD OR POWER SUPPLY VOLTAGE OF THE MOTOR SHOULD BE CHANGED, PLEASE CONTACT WITH US

5. 其它 OTHERS

<p>(1) 本款风机的知识产权属于本公司 在本款风机的使用上不会发生专利问题 应用本风机形成有关产品或方法及新的技术方案造成专利侵权 本公司不予保证 请贵公司特别注意 THE INTELLECTUAL ASSET OF THE FAN IN THE FORM OF PATENT BELONGS TO OUR CORPORATION SO ANY PATENT PROBLEM WILL NOT BE CAUSED DURING THE ACTUAL APPLICATION. OUR CORPORATION WILL NOT BE RESPONSIBLE FOR ANY PATENT DISPUTE OR PROBLEM THAT CAUSED BY THE PRODUCT METHOD AND NEW TECHNIQUE PROJECT WHICH ARE DEVELOPED BY USING THIS FAN</p>
<p>(2) 贵公司保证未经本公司许可 不得将此技术规格书泄漏给其它任何第三方 IT SHOULD BE ASSURED THAT THIS SPECIFICATION CAN NOT BE REVEALED TO ANY THIRD PARTY WITHOUT THE CONSENT OF OUR CORPORATION</p>
<p>(3) 本电机Pb Cr (VI+) Cd Hg PBB PBDE 6种物质的含有量满足RoHS指令(2002/95/EC)的要求 MATERIALS OF MOTOR CONTAIN SIX SUBSTANCES Pb Cr (VI+) Cd Hg PBB AND PBDE, THOSE CONTENTS COMPLY WITH THE RoHS INSTRUCTION</p>

6. P-Q曲线图 P-Q CURVES

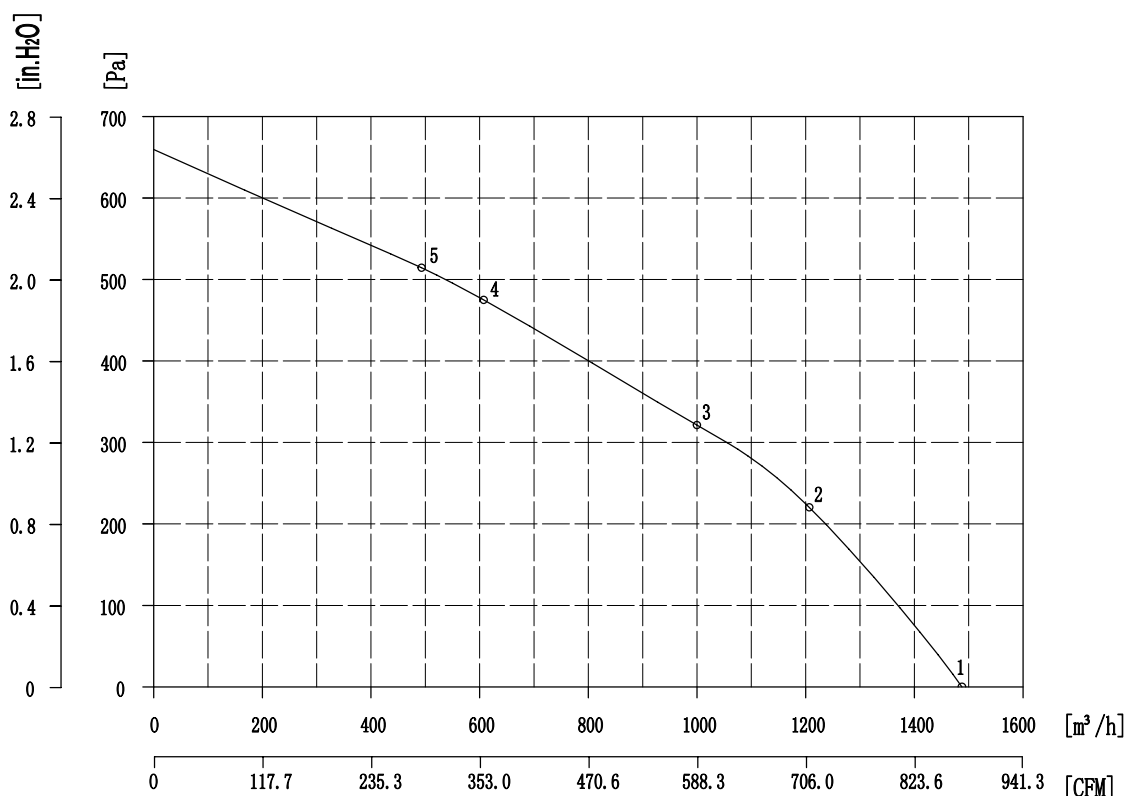

7. 控制方式及应用

NOTES ON VARIOUS CONTROL POSSIBILITIES AND THEIR APPLICATIONS

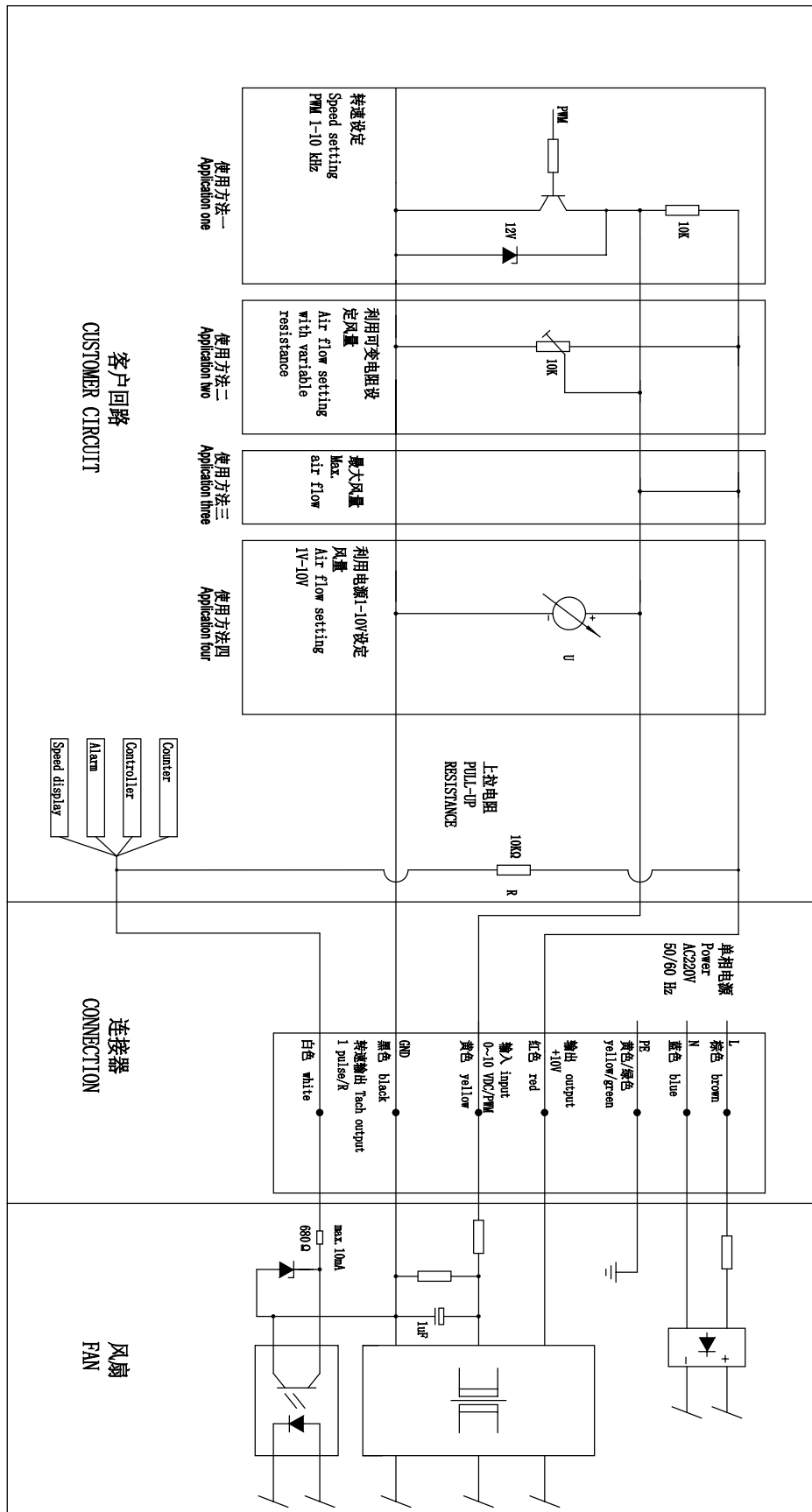

8. 外形图/DIMENSIONED DRAWING

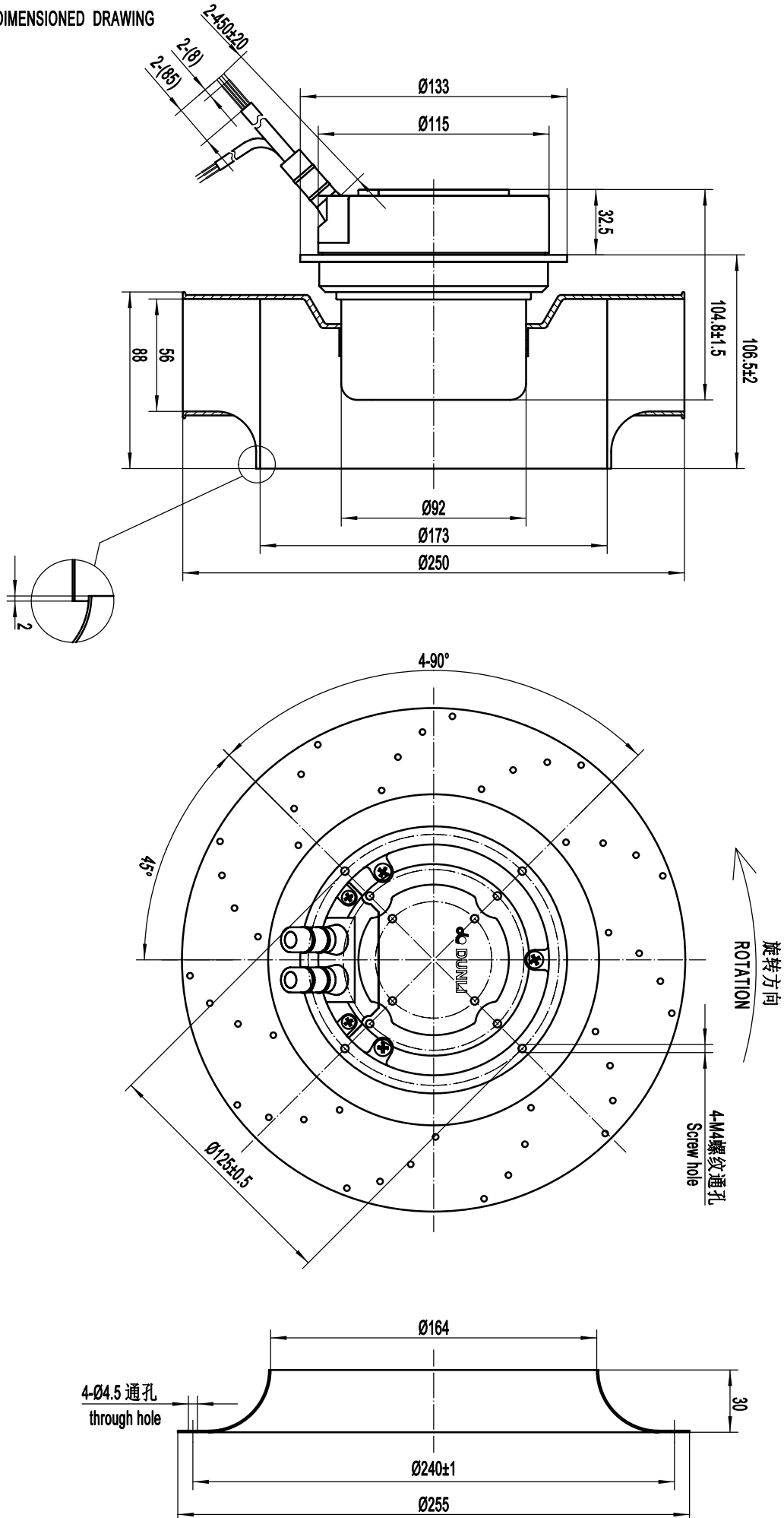

9. 引线式样 LEAD WIRES ASS'Y

【引线①式样】

【LEAD WIRES ASS'Y ①】

电线

WIRES:3*AWG18

信号名 SIGNAL	颜色 COLOR	规格 SPEC
L	棕 BROWN	AC220V/50Hz
N	蓝 BLUE	AC220V/50Hz
PE	黄/绿 YELLOW/GREEN	接地 EARTH

【引线②式样】

【LEAD WIRES ASS'Y ②】

电线

WIRES:4*AWG22

信号名 SIGNAL	颜色 COLOR	规格 SPEC
Vcc	红 RED	DC10V输出
Vsp	黄 YELLOW	0-10V/PWM
GND	黑 BLACK	GND
FG	白 WHITE	1Pulse/R

10. 铭牌 LABEL (选中请打勾 PLEASE TICK AT YOUR CHOISE)

中文 CHINESE

【铭牌一内容 LABEL ONE CONTENTS】



【铭牌二内容 LABEL TWO CONTENTS】

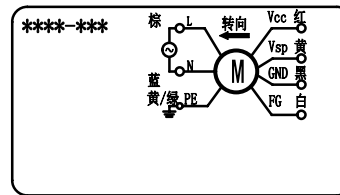

英文 ENGLISH

【铭牌一内容 LABEL ONE CONTENTS】

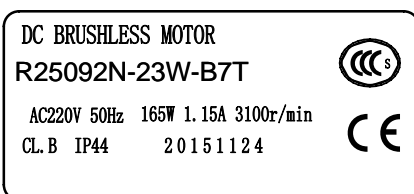

【铭牌二内容 LABEL TWO CONTENTS】

