





# SPECIFICATION FOR APPROVAL

TO : \_\_\_\_\_

REF. No. \_\_\_\_\_

APPROVED DATE 	CHECKED DATE  	PREPARED DATE 
--	---	--

MODEL No. AD0824MX-A70GL P.S. (T)

DESCRIPTION: DC FAN (RoHS) REV. A

ID No. \_\_\_\_\_

THIS OFFER IS MADE ACCORDING TO YOUR CURRENT INQUIRY.  
UNLESS OTHERWISE REVISED, THIS SPECIFICATION WILL BE FINAL FOR  
ALL FUTURE PRODUCTION OF ORDERS FROM YOUR RESPECTED COMPANY

KINDLY STUDY IN DETAILS AND RETURN TO US THE DUPLICATE DULY  
SIGNED AS YOUR CONFIRMATION OF SAME.



ADD A CORP.  
REGISTERED TO ISO 9001  
ISO/TS 16949  
CERTIFICATE NO. A8035

**ADD A** **ADD A CORPORATION**

D A T A - S H E E T

Engineering

BRUSHLESS AXIAL COOLING FANS.

Printed on: 08/07/30

Customer :	Ref: (RoHS)																																		
ADDA Model No. : AD0824MX-A70GL	P.S:(T)																																		
Samples attached :	piece(s)																																		
Safety Approval :	UL,CUL,CSA,TUV,CE																																		
<b>Specifications</b> ===== <table border="1"> <thead> <tr> <th>ITEM</th> <th>SPECIFICATION / CONDITION</th> </tr> </thead> <tbody> <tr> <td>DIMENSIONS</td> <td>: 80x80x25 MM</td> </tr> <tr> <td>BEARING TYPE</td> <td>: HYPRO</td> </tr> <tr> <td>RATED VOLTAGE</td> <td>: 24.0 VDC</td> </tr> <tr> <td>OPERATING VOLTAGE RANGE</td> <td>: 21.6 VDC - 26.4 VDC</td> </tr> <tr> <td>START-UP VOLTAGE</td> <td>: 17.0 VDC, NOMINAL</td> </tr> <tr> <td>RATED / ACTUAL CURRENT</td> <td>: 0.100 Amp. + 10% MAX / 0.070 Amp</td> </tr> <tr> <td>RATED / ACTUAL POWER</td> <td>: 2.40 / 1.68 watt.</td> </tr> <tr> <td>RATED SPEED</td> <td>: 2400 RPM ± 10% (IN FREE AIR AT RATED VOLTAGE)</td> </tr> <tr> <td>AIR FLOW</td> <td>: 31.4 CFM (IN FREE AIR AT RATED VOLTAGE)</td> </tr> <tr> <td>STATIC AIR PRESSURE</td> <td>: 0.114 Inch Water (IN FREE AIR AT RATED VOLTAGE)</td> </tr> <tr> <td>NOISE LEVEL</td> <td>: 28.3 dB(A)</td> </tr> <tr> <td>MOTOR PROTECTION</td> <td>: BY IMPEDANCE</td> </tr> <tr> <td>CONNECTION LEAD TYPE</td> <td>: WIRE ,AWG#24</td> </tr> <tr> <td>LIFE EXPECTANCY</td> <td>: 40000 Hours at 40°C / 65%</td> </tr> <tr> <td>NET WEIGHT</td> <td>: 86 Gram.</td> </tr> <tr> <td>PACKING</td> <td>: 200 pcs. per Export Carton</td> </tr> </tbody> </table> <p>Unless otherwise stated, the relative humidity is 65%, and the temperature is 40°C for the standard testing.</p> <p>should you have any doubt, please refer to the environmental conditions specified in the acknowledgement document.</p>		ITEM	SPECIFICATION / CONDITION	DIMENSIONS	: 80x80x25 MM	BEARING TYPE	: HYPRO	RATED VOLTAGE	: 24.0 VDC	OPERATING VOLTAGE RANGE	: 21.6 VDC - 26.4 VDC	START-UP VOLTAGE	: 17.0 VDC, NOMINAL	RATED / ACTUAL CURRENT	: 0.100 Amp. + 10% MAX / 0.070 Amp	RATED / ACTUAL POWER	: 2.40 / 1.68 watt.	RATED SPEED	: 2400 RPM ± 10% (IN FREE AIR AT RATED VOLTAGE)	AIR FLOW	: 31.4 CFM (IN FREE AIR AT RATED VOLTAGE)	STATIC AIR PRESSURE	: 0.114 Inch Water (IN FREE AIR AT RATED VOLTAGE)	NOISE LEVEL	: 28.3 dB(A)	MOTOR PROTECTION	: BY IMPEDANCE	CONNECTION LEAD TYPE	: WIRE ,AWG#24	LIFE EXPECTANCY	: 40000 Hours at 40°C / 65%	NET WEIGHT	: 86 Gram.	PACKING	: 200 pcs. per Export Carton
ITEM	SPECIFICATION / CONDITION																																		
DIMENSIONS	: 80x80x25 MM																																		
BEARING TYPE	: HYPRO																																		
RATED VOLTAGE	: 24.0 VDC																																		
OPERATING VOLTAGE RANGE	: 21.6 VDC - 26.4 VDC																																		
START-UP VOLTAGE	: 17.0 VDC, NOMINAL																																		
RATED / ACTUAL CURRENT	: 0.100 Amp. + 10% MAX / 0.070 Amp																																		
RATED / ACTUAL POWER	: 2.40 / 1.68 watt.																																		
RATED SPEED	: 2400 RPM ± 10% (IN FREE AIR AT RATED VOLTAGE)																																		
AIR FLOW	: 31.4 CFM (IN FREE AIR AT RATED VOLTAGE)																																		
STATIC AIR PRESSURE	: 0.114 Inch Water (IN FREE AIR AT RATED VOLTAGE)																																		
NOISE LEVEL	: 28.3 dB(A)																																		
MOTOR PROTECTION	: BY IMPEDANCE																																		
CONNECTION LEAD TYPE	: WIRE ,AWG#24																																		
LIFE EXPECTANCY	: 40000 Hours at 40°C / 65%																																		
NET WEIGHT	: 86 Gram.																																		
PACKING	: 200 pcs. per Export Carton																																		
ADDA CORPORATION	Model No.: AD0824MX-A70GL P.S:(T)																																		
	Page 1/4																																		



# SPECIFICATION

## 1.0 SCOPE

- 1.1 If the information or other related document is inconsistent with this acknowledgement document, please refer to the acknowledge document.
- 1.2 This documentation defines the mechanical & electrical characteristics of DC brushless fans.
- 1.3 The specification of this product is described in details in the acknowledgement document. No guarantee is given to our product under the use of over specifications.
- 1.4 For any change or amendment to the specifications, such change will be noticed in writing beforehand.
- 1.5 If the product is used on the MIS system, please specify the specification in the purchase order.

## 2.0 MATERIAL

- 2.1 Frame : UL94V-0 Glass Filled polyester (P.B.T)
- 2.2 Fan Blade : UL94V-0 Glass Filled polyester (P.B.T)
- 2.3 Bearing Sys. : ( ) Sleeve, oil impregnated.  
 ( ) Two Ball Bearing  
 ( ) One Ball one Sleeve  
 (V) Hypro Bearing  
 ( ) FDB Bearing
- 2.4 RoHS : (V) YES

## 3.0 DIMENSIONS & CONSTRUCTION

All dimensions, Direction of rotation and air flow were specified as per drawing attached.

## 4.0 CHARACTERISTICS & DEFINITION

- 4.1 All rated characteristics were specified as per data sheet enclosed.
- 4.2 Rated Current : Rated Current shall be measured after 3 minutes of continuous rotation at rated voltage.
- 4.3 Rated Speed : Rated Speed shall be measured after 3 minutes of continuous rotation at rated voltage.
- 4.4 Start Voltage : The voltage which is able to start the fan to operate by suddenly switching 'ON'.
- 4.5 Input Power : Input Power shall be measured after 3 minutes of continuous rotation at rated voltage.
- 4.6 Locked Rotor Current : Locked current shall be measured within one minute of rotor locked, after 3 minutes of continuous rotation at rated voltage in clean air.
- 4.7 Air Flow & Static Pressure : The air flow data and static pressures should be determined in accordance with AMCA standard or DIN24163 specification in a doublechamber testing with intake - side measurement.
- 4.8 Noise Level : The measurement of noise level is carried out with reference to CNS8753 in an anechoic chamber with the microphone positioned 1 meter from the air intake. Testing fan shall be hung in clean air.

### NOISE LEVEL MEASUREMENT

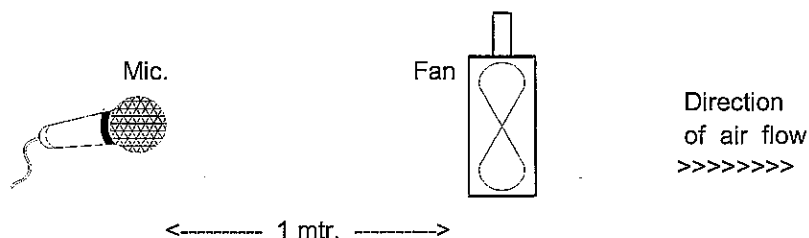

# SPECIFICATION

## 5.0 MECHANICAL INSPECTION

### 5.1 Rotation Direction

Counterclockwise when look into impeller side.

### 5.2 Protection

All fans have integrated protection against locked rotor condition so that there will be no damage to winding or any electronic component.

Restarting is automatic as soon as any constraint to rotation has been released.

As fan placed at dead angle position, and the switch was changed from off to on. Restarting was automatic normal as soon as and proved that this fan is good fan.

### 5.3 Locked Rotor Protection

No damage shall be found after 72 hours continuously at condition of rotation locked.

Restarting is automatic as soon as constraint to running has been released.

### 5.4 Avoid the damage, check the correct voltage and proper polarity before connecting with power.

### 5.5 Free Drop Shock

In minimum package condition, the fan should withstand drops on any three faces from a height of 30cm onto a wood board of 10mm thick.

### 5.6 Please do not stick a grease and/or an oil to the fan housing or blade which may have a harmful influence by a chemical reaction at high humidity.

### 5.7 If the fan is reinstalled, please pay special attention to the noise due to the vibration (or resonance).

### 5.8 During the testing of the fan, please make sure the finger guard is used for safety.

## 6.0 ELECTRICAL INSPECTION

### 6.1 Insulation Resistance

Not less than 10M ohm between housing and positive end of lead wire (red) at 500V DC.

### 6.2 Dielectric Strength

No damage should be found at 500 VAC for 60 seconds, measured with 1mA trip current between housing and positive end of lead wire.

### 6.3 Life Expectancy

The continuous duty life at given temperature after which, 90% of testing units shall still be running.

### 6.4 While the fan is running, do not intentionally lock the fan for a long time since the overheating of the motor produced by the long-time locking will damage the fan.

## 7.0 ENVIRONMENTAL

### 7.1 Improper use such as disassembling the fan, being covered with dust, or dipping the fan in water that results in defects is not covered in the warranty. Do not use the fan in the environment with corrosive air or liquid.

### 7.2 Operating Temperature / Humidity

-10°C to +70°C at humidity 65%+/-20% RH.

### 7.3 Storage Temperature

All function shall be normal after 500 hours storage at -40°C to +70 °C with a 24 hour recovery period at room temperature.

### 7.4 Humidity

After 96 hours, 95% RH, 40+/-2°C per MIL-STD-202F, method 103B humidity test, the measured data on insulation resistance and dielectric strength shall meet the specification.

### 7.5 Do not place or store the fan in the environment with high/low temperature/humidity. Do not store the fan for over 6 months; even if the fan is stored in room temperature for over 6 months, the fan may have the electric current leakage.



# SPECIFICATION

## 8.0 REMARKS

- 8.1 Material and construction are subject to change without advance notice. The changes should be within specification.
- 8.2 All fans shall meet the quality inspection under sampling plan MIL-STD-105E as follow:

Critical	0.25%
Major	1.00%
Minor	2.50%

## 9.0 OUTLINE STYLING & DIMENSIONS

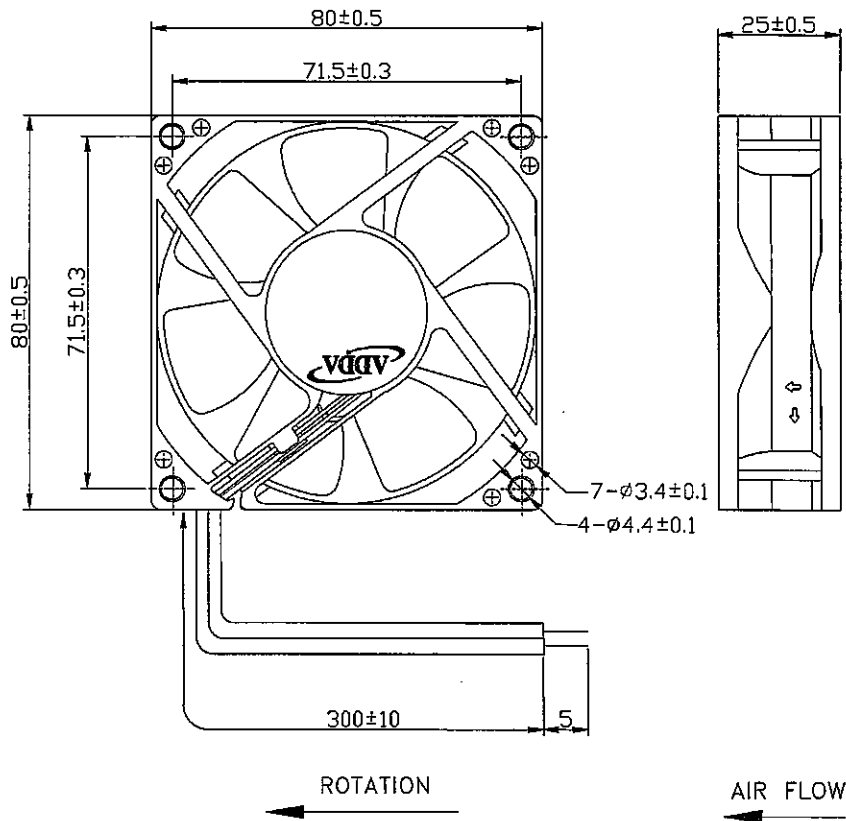

LEAD WIRES : UL 1007, AWG24 , L=300 +/- 10 MM  
 Red = positive ; Black = negative.

## 10.0 Notes:

- 10.1 Please do not touch and push Fan Blade with fingers or others, fan blade and hypro bearings may be damaged and it causes noise defect.
- 10.2 Do not carry the fan by its lead wires.
- 10.3 If the fan does not have the polarity protection function, the connection of the colored wires should be red + red, and black + black, or else the fan will be damaged in no time.
- 10.4 For the models without reverse connection of polarity protection, please do not connect the lead wire in reverse





Models AD0412HB-C70, -C71, AD0412HS-C70, -C71, AD0412MB-C70, -C71, AD0412MS-C70, -C71, AD0412LB-C70, -C71, AD0412LS-C70, -C71, AD06(A)(B)(C)-(F), AD0605M(C)-A70GL, AD0612(B)(C)-(E), AD08(A)(B)(C)-(D), AD08(A)(B)(C)-(G), AD0812H(C)-A74GL series, where (A) may be 12 or 24, (B) may be H, L or M, (C) may be B, S or X, (D) may be A70GL, A71GL, A76GL, (E) may be C70GL, C71GL, (F) may be A70GL, A71GL, A72GL or A73GL, (G) may be A72GL, A73GL.

Models AD08(A)(B)(C)-A(D), AD08(A)(B)X-A(E), AD09(A)(B)(C)-A(D), AD09(A)(B)(X)(F)-(G), AD12(A)(B)(C)-A(E), AD12(A)(B)(X)(F)-A71GL, -A72GL series, where (A) may be 12 or 24, (B) may be H, L or M, (C) may be B or S, (D) may be 50, 51, 70, 71 or 72, (E) may be 70 or 71, (F) may be B, S or X, (G) may be A70GL or A72GL; Models AD12(A)(B)(C)-A(E), AD12(A)(B)(D)-A(E)GL, where (A) may be 12 or 24, (B) may be H, L or M, (C) may be B or S, (D) may be B, S or X, (E) may be 70 or 71.

Models AD0205(A)(B)-(C)(D), AD0212(A)(B)-(C)(D), AD0305(A)(B)-(C)(D), AD0312(A)(B)-(C)(D), AD2005(A)(B)-(C)(D), AD2012(A)(B)-(C)(D) series, where (A) may be D, H, L or M, (B) may be B, S or X, (C) may be G, (D) may be 50 or 70.

Model AD2512HB-BV7.

Models AD0305(D)(B)-G56, AD0312L(B)-G50, AD0405(A)(B)-C50, AD0412(B)(C)-C50 series, where (A) may be L or M, (B) may be B, S or X, (C) may be H, L or M, (D) may be D or L.

Models AD0405LX-K90, AD0405MX-K90, AD0412MX-K90, AD0512LX-G70, AD0512MX-G70, AD0612HY-D74GL series, where (Y) may be B, S or X, (X) may be B or X.

Models AD08(A)(B)(D)-C71, AD09(A)(B)(C)-C71, AD08(A)(B)(D)-C70, AD09(A)(B)(C)-C70, where (A) may be 12 or 24, (B) may be H or M, (C) may be B or S, (D) may be B, S or X.

Model AD(A)(B)(C)(D)-(E)(F), where (A) may be 02, 04, 05, 08, (B) may be 05, 12 or 24, (C) may be H, M or L, (D) may be S, X or B, (E) may be D or G or K, (F) may be 53, 70, 71, 72, 76.

Model ADabcd - efgh, where (a) may be 04, 06, 08 or 09, (b) may be 05, 12 or 48, (c) may be U, H, M or L, (d) may be B, S or X, (e) may be A, D, G, J or K, (f) may be 7, 9, A or C, (g) may be 0, 1, 3 or 6, (h) may be GL or blank.

Models AD12(A)(B)(C)-F5(D), AD1212H(C)-F5(E), AD1224H(C)-F5(F), AD1226H(C)-F51, where (A) may be 12, 24 or 48, (B) may be H, M or L, (C) may be B, S, V or X, (D) may be 1, 2 or 3, (E) may be 4, 5, 6 or 7, (F) may be 4 or 6.

Models AD2512(A), AD2524(A), where (A) may be MB, MS or MX.

Models AD08, AD09 followed by (A)(B)(C)-A5(D), where (A) may be 12 or 24, (B) may be H, L or M, (C) may be B or S, (D) may be 2 or 3.

Models AD0212HB-G71, AD0405HB-G91, AD0405HS-G91, AD0405MB-E81, -G91, AD0405MS-G91, AD0406MB-E81, AD0412HB-E81, -G91, AD0412HS-E81, -G91, AD0412LB-E81, AD0412LS-E81, AD0412MB-E81, -G91, AD0412MS-E81, -G91, AD0605HB-D71, AD0612HB-D71, AD0612HS-D71, AD0612LB-D71, AD0612LS-D71, AD0612MB-D71, AD0612MS-D71.

Models AD06(A)(B)(C)-(F), AD0612(B)(C)-(E), AD08(A)(B)(C)-(D), AD08(A)(B)(C)-(G)AD0605M(C)-A70GL, AD0812H(C)-A74GL, where (A) may be 12 or 24, (B) may be H, M or L, (C) may be B, X or S, (D) may be A70GL, A71GL or A76GL, (E) may be C70GL, C71GL, (F) may be A70GL, A71GL, A72GL or A73GL.

Model AD75(A)(B)(C), where (A) may be 12 or 24, (B) may be H or M, (C) may be B, S or X.

Models AD04(A)(B)(C)-G70, AD0403L(C)-G70, AD0405(D)(C)-K96, AD0424(B)(C)-C70, where (A) may be 05 or 12, (B) may be H or M, (C) may be B, S or X, (D) may be H, L or M; Model BD0412MS-G70.

Model AD04(A), (B), (C), (D) or (E), where (A) may be 05, 12 or 24, (B) may be H, L or M, (C) may be B, S or X, (D) may be C or K, (E) may be 50, 51, 52, 53, 56 or C3.

Models AA128(A)(B)(C)-(D), AA838(A)(E)(C)-(F), where (A) may be 1 or 2, (B) may be D, H, L or M, (C) may be B, S or X, (D) may be AT, AW, PT or PW, (E) may be H or M, (F) may be AT or AW.

Model AD0612UB-D72GL.

Models AA1281U(A)-(B), AA1282U(A)-(B), where (A) may be B, S or X, (B) may be AT or AW.

Models AD05(A)(B)(C)-(D), AD0505(E)(C)-G76, AD0512(E)(C)-(F), AD0512M(C)-D76, where (A) may be 05 or 12, (B) may be H or M, (C) may be B, S or X, (D) may be D70, D71 or G90, (E) may be H, L or M, (F) may be G70 or G76.

Models AD08(A)(B)(C)-D71, AD08(D)UB-A(E)GL, AD0812(B)B-D74, where (A) may be 05 or 12, (B) may be H or M, (C) may be B, S or X, (D) may be 12 or 24, (E) may be 71, 72 or 73.

Models AD06(A)(B)(C)-(E), AD06(A)(D)(C)-G90, AD0612(D)(C)-G96, where (A) may be 05 or 12, (B) may be H or M, (C) may be B, S or X, (D) may be H, L or M, (E) may be D71GL, D72GL or D73GL.

Model AD02(A)(B)-G70, where (A) may be 05 or 12, (B) may be B, S or X; Model AD0205L(C)-G50, where (C) may be B or X.

Models AD09(A)(H)(C)-A74GL, AD0912(B)(C)-A76GL, where (A) may be 12 or 24, (B) may be H, L or M, (C) may be B, S or X; Models AD4505H(B)-G70, AD4512(A)(B)-(C), where (A) may be H or M, (B) may be B, S or X, (C) may be G7 or G76.

Models AD0912(A)(Y)-A(W)GL, AD0912(A)(Y)-A2GL, where (A) may be H, L, M or U, (Y) may be B, S or X, (W) may be 71, 72 or 73.

Model AD0924XY-A7ZGL, where X may be U, H, M or L, Y may be X, B or S, Z may be 0, 1, 2 or 3.

Model AD1224(A)(B)-A74GL, where (A) may be H, L or M, (B) may be B, S or X.

Models AD0305L(X)-K70, AD0312L(X)-K70, where (X) may be B or X; Model AD0424MB-G70.

Models AD0412H(Y)-D50, AD0412H(Y)-D56, AD0412L(Y)-D50, AD0412L(Y)-D56, AD0412M(Y)-D50, AD0412M(Y)-D56, where (Y) may be B, S or X; Model AD0612M(B)-D70GL, where (B) may be B, S or X; Model AD0812MB-D76.

Model AD0612M(B)-D70GL, where (B) may be B, S or X; Model AD0812MB-D76; Models AD0612D(Y)-D70GL, AD0612D(Y)-D76GL, AD0612H(Y)-D70GL, AD0612H(Y)-A76GL, AD0612H(Y)-D76GL, AD0612L(Y)-D70GL, AD0612L(Y)-A76GL, AD0612L(Y)-D76GL, AD0612M(Y)-D70GL, AD0612M(Y)-A76GL, AD0612M(Y)-D76GL, AD0624H(Y)-D70GL, AD0624H(Y)-D76GL, AD0624M(Y)-D70GL, AD0624M(Y)-D76GL, where (Y) may be B, S or X.

Models AD0612H(Y)-A76GL, AD0612L(Y)-A76GL, AD0612M(Y)-A76GL, where (Y) may be B, S or X.

Model AD0624UX-A79GL.

Models AD0612XY-C72GL, AD0612XY-C73GL, AD0612XY-C76GL, AD0624XY-C70GL, AD0624XY-C76GL series, where X may be H, L or M, Y may be B, S or X.

Model AP45(A)(B)(C)-J(D)(E), where (A) may be 05 or 12, (B) may be H, M or L, (C) may be B or X, (D) may be J or G, (E) may be 90 or 96.

Model AD(P1)(P2)(P3)(P4)-G(P5), where (P1) may be 04, 05 or 45, (P2) may be 05, 12 or 24, (P3) may be L, M, H or U, (P4) may be B, X or S, (P5) may be 76 or 77; Models AD02(A)(B)(C)-(D)(E), AD03(A)(B)(C)-(D)(E), AD35(A)(B)(C)-(D)(E), where (A) may be 05 or 12, (B) may be L, M and D, (C) may be B or X, (D) may be B, S or X, (E) may be 50 or 53.

Model AD12(X1)(X2)(X3)-F(X4), where (X1) may be 12, 24 or 48, (X2) may be H, L, M or U, (X3) may be B, S or X, (X4) may be 51, 52 or 53.

Model Atu05vw-xyz, where t may be B or D, u may be 03, 04, 05 or 45, v may be H, L or M, w may be B, S or X, x may be G or R, y may be 7, B or Z, z may be 1, 3 or B.

Model AD(A)48H(B)-(C)(D)8(E), where (A) may be 08, 09 or 12, (B) may be B, S or X, (C) may be A or F, (D) may be 5 or 7, (E) may be GL or blank.

Model AD(A)24(B)(C)-A7(D)GL, where (A) may be 09 or 12, (B) may be H or M, (C) may be B, S or X, (D) may be 4 or A.

Model AD0505(A)(B)-G70, where (A) may be H, M or L, (B) may be B, S or X.

Models AD0524HB-G70, AD0524HS-G70, AD0524HX-G70, AD0524MB-G70, AD0524MS-G70, AD0524MX-G70, AD0524LB-G70, AD0524LS-G70, AD0524LX-G70, AD0524HB-G76, AD0524HS-G76, AD0524HX-G76, AD0524MB-G76, AD0524MS-G76, AD0524MX-G76, AD0524LB-G76, AD0524LS-G76, AD0524LX-G76, AD0612UB-A71GL, AD0612US-A71GL, AD0612UX-A71GL, AD0612UB-A72GL, AD0612US-A72GL, AD0612UX-A72GL, AD0612UB-A73GL, AD0612US-A73GL, AD0612UX-A73GL.

Model AD0612HB-D78GL.

Models AD0812UB-A70GL, AD0812US-A70GL, AD0812UX-A70GL, AD0812UB-A76GL, AD0812US-A76GL, AD0812UX-A76GL, AD0812HB-A76GL, AD0812HS-A76GL, AD0812HX-A76GL, AD0812MB-A76GL, AD0812MS-A76GL, AD0812MX-A76GL, AD0812LB-A76GL, AD0812LS-A76GL, AD0812LX-A76GL, AD0912UB-A70GL,

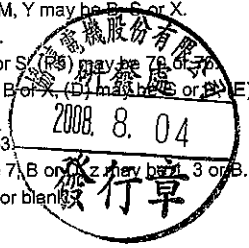

AD0912US-A70GL, AD0912UX-A70GL, AD0912UB-A76GL, AD0912US-A76GL, AD0912UX-A76GL, AD0912DB-A70GL, AD0912DS-A70GL, AD0912DX-A70GL, AD0612HB-G70, AD0612HS-G70, AD0612HX-G70, AD0612MB-G70, AD0612MS-G70, AD0612MX-G70, AD0612LB-G70, AD0612LS-G70, AD0612LX-G70, AD0612HB-G76, AD0612HS-G76, AD0612HX-G76, AD0612MB-G76, AD0612MS-G76, AD0612MX-G76, AD0612LB-G76, AD0612LS-G76, AD0612LX-G76, AD0312MX-G50.

Models AD0412UBC50, AD0412UBC52, AD0412UBC56, AD0412UBD50, AD0412UBD52, AD0412UBD56, AD0412USC50, AD0412USC52, AD0412USC56, AD0412USD50, AD0412USD52, AD0412USD56, AD0412UXC50, AD0412UXC52, AD0412UXC56, AD0412UXD50, AD0412UXD52, AD0412UXD56, AD0412HBC50, AD0412HBC52, AD0412HBC56, AD0412HBD50, AD0412HBD52, AD0412HBD56, AD0412HSC50, AD0412HSC52, AD0412HSC56, AD0412HSD50, AD0412HSD52, AD0412HSD56, AD0412HXC50, AD0412HXC52, AD0412HXC56, AD0412HXD50, AD0412HXD52, AD0412HXD56, AD0412MBC50, AD0412MBC52, AD0412MBC56, AD0412MBD50, AD0412MBD52, AD0412MBD56, AD0412MSC50, AD0412MSC52, AD0412MSC56, AD0412MSD50, AD0412MSD52, AD0412MSD56, AD0412MXC50, AD0412MXC52, AD0412MXC56, AD0412MXD50, AD0412MXD52, AD0412MXD56, AD0412LBC50, AD0412LBC52, AD0412LBC56, AD0412LBD50, AD0412LBD52, AD0412LBD56, AD0412LSC50, AD0412LSC52, AD0412LSC56, AD0412LSD50, AD0412LSD52, AD0412LSD56, AD0412LXC50, AD0412LXC52, AD0412LXC56, AD0412LXD50, AD0412LXD52, AD0412LXD56.

Models AD0305MB-G53, AP0412MX-C70.

Models AD1212UB-F51, AD1212US-F51, AD1212UX-F51, AD1212UB-F52, AD1212US-F52, AD1212UX-F52, AD1212UB-F53, AD1212US-F53, AD1212UX-F53.

Models AB5012HB-C06, AD7512LB, AD7512LS, AD7512LX, AD7512UB, AD7512US, AD7512UX, AD7524LB, AD7524LS, AD7524LX, AD7524UB, AD7524US, AD7524UX.

Models AD0505HX-RBB, AD0505HX-RB0.

Models AD0712HB-A70GL, AD0712HS-A70GL, AD0712HX-A70GL, AD0712MB-A70GL, AD0712MS-A70GL, AD0712MX-A70GL, AD0712LB-A70GL, AD0712LS-A70GL, AD0712LX-A70GL, AD0712HB-A76GL, AD0712HS-A76GL, AD0712HX-A76GL, AD0712MB-A76GL, AD0712MS-A76GL, AD0712MX-A76GL, AD0712LB-A76GL, AD0712LS-A76GL, AD0712LX-A76GL.

Models AA1752HB-AW, AA1752HB-AT.

Models AD0712(A)(B)-DA(C), where (A) may be U, H, M, L or D, (B) may be B, S or X, (C) may be 0 or 6.

Model AA1751(X)B-A(Y), where (X) may be H or M, (Y) may be T or W; Models AD0405(A)(B)-G(C), AD0412(A)(B)-G(C), where (A) may be H, M or L, (B) may be B, S or X, (C) may be 71, 72 or 73.

Model AD0205(A)(B)-Q53, where (A) may be M, L or D, (B) may be B or X.

Model AD4505MX-RB3.

Model AD0405(A)(B)-GA3, where (A) may be H or M, (B) may be B or X.

Model AD12(A)(B)(C)-A7(D)GL, where (A) may be 12 or 24, (B) may be H, M, L or U, (C) may be B, S or X, (D) may be 1, 2 or 3.

AD1224XB-A7(D)GL series, where (D) may be 1, 2 or 3.

Models AD5012(A)(B)-D7(C), where (A) may be H, M, L or U, (B) may be B, S or X, (C) may be 0 or 6.

Models AD0812(A)(B)-C7(D), AD0824(C)(B)-C7(D), where (A) may be U, H, M or L, (B) may be B, S or X, (C) may be H or M, (D) may be 0 or 6.

Models AD2005LB-G73, AB0405HB-G03.

Model AB7005(A)B-SA3, where (A) may be H, M or L.

Model AD12(A)(B)(C)-D(E)F, where (A) may be 12 or 24, (B) may be U, H, M, L or D, (C) may be B, S or X, (D) may be Y or A, (E) may be 51, 52, 53, 74 or 7A, (F) may be GL or blank.

Models AE1281B, AE1281S, AE1281X.

Model AD0812(A)(B)-D7(C), where (A) may be H, M or L, (B) may be B, S or X, (C) may be 1 or 3.

AC fans, Models AA1282(X)(Y)-A(Z)GL, AA1282(X)(Y)-A(Z)GL5, AA1252M(Y)-A(Z)GL, where (X) may be H, M, L or D, (Y) may be B, X or S, (Z) may be T or W.

Model AA1251M(X)-A(Y)GL series, where (X) may be B or S, (Y) may be T or W.

Models AK8251HB, AK8252HB, AK9251HB, AK9252HB, AK1281HB, AK1282HB, AK1751HB, AK1752HB, AK8251MB, AK8251LB, AK8381HB, AK8381MB, AK8381LB, AK9251MB, AK9251LB, AK9381HB, AK9381MB, AK9381LB, AK1251HB, AK1251MB, AK1251LB, AK1281MB, AK1281LB, AK8252MB, AK8252LB, AK8382HB, AK8382MB, AK8382LB, AK9252MB, AK9252LB, AK9382HB, AK9382MB, AK9382LB, AK1252HB, AK1252MB, AK1252LB, AK1282MB, AK1282LB, AK1651HB, AK1651MB, AK1651LB, AK1751MB, AK1751LB, AK2071HB, AK2581HB, AK2581MB, AK1652HB, AK1652MB, AK1652LB, AK1752MB, AK1752LB, AK2072HB, AK2582HB, AK2582MB, AK1781HB, AK1782HB, AK1861HB, AK1862HB.

Models AA1751(X)B-A(Y)SC, AA1752(X)B-A(Y)SC series, where (X) may be H, M or L, (Y) may be T or W; Models AA2072HB-AWSC, AA2582HB-AWSC.

Models AX25892LB, AX25891LB, AX17382HB, AX17381HB, AX25891HB, AX25891MB.

DC fans, Models AD0405UB-GA3, AD0405UX-GA3, AD0612(X)B-D9(Y), where (X) may be U or H, (Y) may be 1, 2 or 3.

Model AD0305(X)(Y)-Q7(Z), where (X) may be H, M or L, (Y) may be B or X, (Z) may be 1 or 3.

Model AD0624(X)(Y)-A7(Z)GL, where (X) may be U, H or M, (Y) may be B, X or S, (Z) may be 1, 2 or 3.

Models AD5105HB-L06, AD4605HB-GC3.

Models AD0605(X)(Y)-D7(Z)GL, AD0605(P)(Y)-A7(Z)GL, where (X) may be U, H, M or L, (Y) may be B, S or X, (Z) may be 1, 2 or 3, (P) may be H, M or L.

Model AD0848H(X)-A7(Y)GL, where (X) may be B, S or X, (Y) may be 0 or 6.

Model AB0405UB-G03.

Model AD0412(A)(B)-B3(C), where (A) may be H, M or L, (B) may be B, S or X, (C) may be 1, 2 or 3.

Models AD0924XB-A71GL, AD0924XB-A72GL, AD0924XB-A73GL.

Models AB3505HB-QB3, AB0605HB-E03, AD2705HB-Q73, AD4505HB-H03.

Models AB7012HB-E01, AB7012HB-E02, AB7012HB-E03.

Models AB6812HX-GC0, AB6812MX-GC0, AB6812LX-GC0.

Models AB7005HB-E0(X), AB6105HB-DC(X), where (X) may be 1, 2 or 3.

Model AB0605(A)(B)-E0(C), where (A) may be H or M, (B) may be B, S or X, (C) may be 1, 2 or 3.

Model AP5212(X)(Y)-E7(Z), where (X) may be H, M, L or D, (Y) may be X or B, (Z) may be 0 or 6.

Models AB4805HB-L03, AB5505M(A)-GD(B), where (A) may be B or X, (B) may be 1, 2 or 3.

Model AB3512(X)(Y)-QB(Z), where (X) may be U, H, M or L, (Y) may be B or X, (Z) may be 0 or 6.

Models AB4505H(A)-GD(B), AB4505M(A)-GD(B), AB4505L(A)-GD(B), AD4505HB-T0(B), AD0605DB-D9(B), AD0712UB-D9(B), AB4512(X)(D)-QA(C), AD5012(X)(A)-D7(B), where (A) may be B, S or X, (B) may be 1, 2 or 3, (X) may be H, M or L, (D) may be B or X, (C) may be 0 or 6.

Models AD0424(B)(Y)-D5(U), AD0612LS-D90, AD0612(X)(Y)-D7(Z)GL, AD0812(A)(Y)-A7(Z)GL, AD0812HS-A70GL, AD0424(B)(Y)-C5(Z), where (A) may be H, M, L or D, (B) may be H, M or L, (X) may be U, H, M, L or D, (Y) may be B, S or X, (U) may be 0 or 6, (W) may be 1 or 2, (Z) may be 1, 2 or 3.

Models AD5012HB-S01, AD5012HB-S02, AD5012HB-S03.

Model AD0812H(X)-A78GL, where (X) may be B, S or X.

Model AD0848HB-A7(X)GL, where (X) may be 1, 2 or 3.

Model AD0205(X)(Y)-G50, where (X) may be H, M, L or D, (Y) may be B or X.

Model AB3505(X)(Y)-QB0, where (X) may be H, M or L, (Y) may be B or X.

Model AD0605HB-TB(X) where (X) may be 1, 2 or 3.

Models AD0512(X)X-RB(Y), AD0512(X)B-RB(Y), where (X) may be H or M, (Y) may be 0 or 6.

Models AD0412UB-G7(Y), AD0412D(Z)-G7(Y), AB0605HB-TB(X), where (X) may be 1, 2 or 3, (Y) may be 0 or 6, (Z) may be B, S or X.

Models AB3505(X)B-GA(Z), AB3505(X)X-GA(Z), AB5012(X)(Y)-C0(W), AD0812U(Y)-C7(W), AD0812(X)(Y)-C7(W), AD0812D(Y)-C7(W), AD0812UB-F7(W), AD0812(X)(Y)-F7(W), AD0812D(Y)-F7(W), where (X) may be H, M or L, (Y) may be B, S or X, (Z) may be 0 or 6, (W) may be 1, 2 or 3.

Model AD0612M(X)-GA0, where (X) may be S, X or B.

Model AD5512HB-SC(X), where (X) may be 1, 2 or 3.

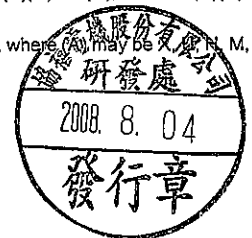

Model AD3505(X)(Y)-G5(Z), where (X) may be H, M or L, (Y) may be B or X, (Z) may be 1 or 2.

Models AD0824H(X)-A7(Y)GL, AD0824H(X)-A7(Y)GL, AB0912MB-Z0(Z), AB0912LB-Z0(Z), where (X) may be B, S or X, (Y) may be A, 4 or 8, (Z) may be 1, 2 or 3.

Models AD0612(X)(Y)-GA(Z), AD0712(W)(Y)-D7(Z), where (X) may be H, M or L, (W) may be M, L or D, (Y) may be B, S or X, (Z) may be 0 or 6.

Models AB0812HB-C03, AB6812HB-A03, AB7312HB-M03.

Models AD0305(X)(A)-D50, AD0312(X)(A)-D50, AD3503HB-G52, AD0712U(Y)-A7(W)GL, AD0712(X)(Y)-A7(W)GL, AD0712(X)B-DA(W), AD0712DB-DA(W), AD0812D(Y)-A7(Z)GL, (A) may be B or X, where (X) may be H, M or L, (Y) may be B, S or X, (Z) may be 0 or 6, (W) may be 1, 2 or 3.

Models AD0712U(X)-A7(Y)GP, AD0712H(X)-A7(Y)GP, AD0812U(X)-A7(Y)GL, AD0912U(X)-A7(Y)GL, where (X) may be B, X or S, (Y) may be B or 9.

Models AD0405HB-GD(W), AD0505HB-C0(W), AB4512(X)(Y)-GD(Z), where (X) may be H, M or L, (Y) may be B, S or X, (W) may be 1, 2 or 3, (Z) may be 0 or 6.

Models AQ0(X)(Y)(A)B-A7(Z)GL, AQ0(X)(Y)(B)B-A7(W)GL, where (X) may be 8 or 9, (Y) may be 12 or 24, (A) may be H, M or L, (B) may be M or L, (Z) may be 1, 2 or 3, (W) may be 0 or 6.

Models AB0712HB-CC1, AB0712HB-CC2, AB0712HB-CC3.

Models AD3512(X)(Y)-G5(W), AD0505(X)(Z)-G7(W), AD0512(X)(Z)-G7(W), where (X) may be H, M or L, (Y) may be B or X, (W) may be 1, 2 or 3, (Z) may be B, S or X.

Models AD0712(Y)F-D9(A), AD0812(W)F-A7(A)GL, AD0812MF-A7(B)GL, AD0812LF-A7(B)GL, AD0724(Z)F-D9(A), AD0824(X)F-A7(A)GL, AD0824MF-A7(B)GL, AD0824LF-A7(B)GL, where (Y) may be H, M, L or D, (A) may be 1, 2 or 3, (W) may be U, H, M or L, (Z) may be U, H, M, L or D, (X) may be X, U, H, M or L, (B) may be 0 or 6.

Models AD0612XB-D7(W)GL, AD0912UB-Y7(Y)GL, AD0912H(Z)-C7(W), AD0912M(Z)-C7(W), where (W) may be 1, 2 or 3, (Y) may be B or 9, (Z) may be B, S or X.

Models AB6505HB-LB(A), AB5505HB-LB(A), AB7405HB-HB(A), AB0605HB-HB(A), AD0612HB-D0(A), where (A) may be 1 or 3.

Model AB7605HB-HB3.

Models AD3705HB-JA(A), AD5505HB-LC(X), AD5512HB-LC(X), AB0812LB-PB(X), where (X) may be 1, 2 or 3, (A) may be 1 or 3.

Model AD0405HB-GB(A), where (A) may be 1 or 3.

Models AD1212(Z)(Y)-A7(A)GL, AD0412UB-B3(A), AD0812(X)B-Y5(A), AD0612(W)F-D7(A)GL, AD0912(W)F-A7(A)GL, AD1212UX-F57, AD1224UX-F57, where (Z) may be X or D, (Y) may be B, S or X, (X) may be X, U, H, M or L, (W) may be M, L or D, (A) may be 1, 2 or 3.

Models AD0305HB-K9(A), AB1205HB-CB(A), AD0712U(B)-D9(C), AD5012U(B)-D7(A), where (A) may be 1, 2 or 3, (B) may be B, S or X, (C) may be B or 9.

Models AD0612XB-C7(A)GL, AD1212(U)(Y)-A7(B)GL, where (A) may be 1, 2 or 3, (U) may be U, H, M, L or D, (Y) may be B, S or X, (B) may be B or 9.

Models AD0605HB-GC(Y), AB0605H(X)-EB(Y), AB0605U(X)-TB(Y), where (X) may be B or X, (Y) may be 1 or 3.

Models AP3505(U)(W)-J70, AP3512(U)(W)-J70, AD1248(V)(X)-A7(Y)GL, AD0512(V)B-TB(Z), AP0812LS-A00GL, where (U) may be H, M or L, (W) may be B or X, (V) may be U or H, (X) may be B, S or X, (Y) may be 1, 2 or 3, (Z) may be 1 or 3.

Model AB3512(X)(Y)-GA0, where (X) may be H, M or L, (Y) may be B or X.

Models AB0612D(A)-TB(B), AD5024(C)(A)-D7(B), where (A) may be B, S or X, (B) may be 1, 2 or 3, (C) may be V, X, U, H or M.

Models AD4505HB-GB(A), AB8505HB-VB(A), AB0805HB-CB(A), where (A) may be 1, 2 or 3.

Models AD4512HB-E0(Y), AB0912UB-Y0(Y), AD0612VB-A7(Y)GP, where (Y) may be 1, 2 or 3.

Models AD0612U(X)-C7(Y)GL, AD0612(W)(X)-C7(Y)GL, AD0912(W)B-Z7(Z)GL series, where (X) may be B, S or X, (Y) may be 1, 2 or 3, (Z) may be B or 9, (W) may be H, M, L or D.

Models AA8251(A)(B)-A(C), AA8252(A)(B)-A(C), AA9251(A)(B)-A(C), AA9252(A)(B)-A(C), AA1251M(B)-A(C), AA1252M(B)-A(C), where (A) may be H or M, (B) may be S or B, (C) may be T or W.

Models AD1212UB-A3(Y)GL, AD1212DB-A9(Y), AB0512H(X)-RB0, AB0512M(X)-RB0, AB0512L(X)-RB0, AB0512H(X)-RB6, AB0512M(X)-RB6, AB0512L(X)-RB6, where (X) may be B, S or X, (Y) may be 1, 2 or 3.

Models AD0712(Z)(X)-D7(Y), AB1212XB-Y0(Y), AB1212(Z)(X)-Y0(Y), AB1224XB-Y0(Y), AB1224(Z)(X)-Y0(Y) series, where (Z) may be U, H, M, L or D, (X) may be B, S or X, (Y) may be 1, 2 or 3.

Models AD0414MB-G74, AB0612HX-T0(Y), AD4505MB-H0(Y), AD3512H/M(X)-K7(Y) series, where (X) may be B or X, (Y) may be 1, 2 or 3.

Models AD0605HB-EB(X), AB0705HB-EB(X), AD4805HB-TB(X), AD6505HB-GC(Y) series, where (X) may be 1, 2 or 3, (Y) may be 9 or B.

Models AD0424(Y)B-B3(X), AB0912HB-W0(X) series, where (Y) may be H, M or L, (X) may be 1, 2 or 3.

Models AQ0948HB-A71GL, AQ0948MB-A71GL.

Models AD8505HB-GC(X) series, where (X) may be 9 or B.

Models AD1224(A)(X)-Y5(D), AD1248(B)(C)-Y5(D) series, where (A) may be U, H, M, L or D, (B) may be U, H or M, (C) may be B, S or X, (D) may be 1, 2 or 3.

Models AD0405HB-HB(Y), AD0605HB-LB(Y), AD5405HB-TB(Y), AB6805HB-GB(Y), AD5012U(D)-C7(Y), AD5012H(D)-C7(Y), AD5012M(D)-C7(Y), AD5012L(D)-C7(Y) series, where (D) may be B, S or X, (Y) may be 1, 2 or 3.

Model AD0612(X)B-A7(Y)GP series, where (X) may be X, U, H, M, L or D, (Y) may be 1, 2 or 3.

Model AD0612(X)B-A7(Y)GP series, where (X) may be X, U, H, M, L or D, (Y) may be 1, 2 or 3.

Models AD0205H(X)-K50, AD0205M(X)-K50, AD0205L(X)-K50, AD0205D(X)-K50, AD0212H(X)-K50, AD0212M(X)-K50, AD0212L(X)-K50, AD0212D(X)-K50, AB4505M(X)-GA0, AB4505L(X)-GA0, AB4505M(X)-GA6, AB4505L(X)-GA6, AB4512H(X)-GA0, AB4512M(X)-GA0, AB4512L(X)-GA0, AB4512H(X)-GA6, AB4512M(X)-GA6, AB4512L(X)-GA6 series, where (X) may be B or X.

Models AD4512(A)B-G7(D), AD4512(B)(C)-G7(D), AD5805HX-TB(D), AB0612HX-HC(D) series, where (A) may be X or U, (B) may be H, M or L, (C) may be B, S or X, (D) may be 1, 2 or 3.

Models AD1212(A)(C)-F5(D), AD1224(A)(C)-F5(D), AD1248(A)(C)-F5(D), AD2512(B)(C) series, where (A) may be U, H, M, L or D, (B) may be M or L, (C) may be B, S or X, (D) may be 1, 2 or 3.

Model AD0912LB-U7BGL.

Model AB6505HB-HB(Y) series, where (Y) may be 1, 2 or 3.

Models AD0912XB-Y7BGL, AD0912XB-Y79GL.

Model AD1212(X)B-A7(C)GL series, where (B) may be B, S or X, (C) may be B or 9.

Models AB7505HB-HB(X), AB0705HB-HB(X) series, where (X) may be 1, 2 or 3.

Models AD0912UB-Y7(X)GL series, where (X) may be 1, 2 or 3.

Model AB0712HB-CB(X) series, where (X) may be 1 or 3.

Model AQ1212(X)B-Y7(Y)GL series, where (X) may be H, M, L or D, (Y) may be 1, 2 or 3.

Models AD0612M(W)-D9(X), AD0312H(Y)-K70, AD0312L(Y)-K70, AD1348(C)B-F5(Z) series, AD0312MX-K70, where (C) may be V, X, U, H, M or L, (Y) may be B, S or X, (Z) may be 1, 2, 3, 9 or B.

Models AD0424H(A)-G7(C), AD0424M(A)-G7(C), AD0424L(A)-G7(C), AD5605HB-TB(C) series, where (A) may be B, S or X, (C) may be 1, 2 or 3.

Model AD0605(A)(B)-C7(C)GL series, where (A) may be H, M or L, (B) may be B, S or X, (C) may be 0 or 6.

Model AB5605HB-RBB.

Models AD0612UX-A70GL, AD0612UX-A76GL.

Models AD0412MX-K90, AD0405HB-GC(Y) series, where (Y) may be 1, 2 or 3.

Models AB0705HX-TB3, AB0605UB-HB3, AB0512(X)(Z)-RB(Y) series, where (X) may be H, M or L, (Y) may be 1, 2 or 3, (Z) may be B, S or X.

Models AB0612HB-PB3, AD5405HX-TB3, AB0405(X)B-GC(Y) series, where (X) may be H, M or L, (Y) may be 1, 2 or 3.

Models AD0312MB-K70, AD0824M(X)-A7(Y)GL, AD1248(A)B-F9(Z)GP series, where (X) may be B, S or X, (Y) may be 0 or 6, (A) may be U, H, M, L or D, (Z) may be 1, 2, 3, 9 or B.

Models AB0705HX-LB3, AB0705HX-HB3, AB7505HX-HB3, AB7505UX-EB3.

Models AD0624H(B)-A7(C)GL series, AB6505HX-TB3, AB0705HX-EB3, where (B) may be B, S or X, (C) may be 0 or 6.

Models AD0812HB-C71GP, AD0812U(X)-C7(Z)GL series, where (X) may be B or X, (Z) may be 1, 2 or 3; Model AB7505HX-EB3.

Models AD0412UB-G71, AD0412UB-G72, AD0412UB-G73, AD0412US-G71, AD0412US-G72, AD0412US-G73, AD0412UX-G71, AD0412UX-G72, AD0412UX-G73, AD0612UB-A7BGL, AD0612UB-A79GL, AD0612US-A7BGL, AD0612US-A79GL, AD0612UX-A7BGL, AD0612UX-A79GL.





Model AD0312HB-G5(X) series, where (X) may be 0 or 6.  
Models AB0705(Z)X-HB3, AB0505HX-HC3, AD0912UB-A7(Y)GP, AD6512UB-TB6 series, where (Y) may be 1, 2 or 3, (Z) may be U or M.  
Models AD0824US-A7(Y)GL series, where (Y) may be 1, 2 or 3.  
Model AD0812XB-D91GP.  
Models AD0412UB-C7(B)GP, AD0412HB-C7(B)GP, AD0412MB-C7(B)GP, AD0412LB-C7(B)GP, AB0705HX-HC(C) series, where (B) may be 1, 2 or 3, (C) may be 1 or 3.  
Models AB0912DB-Z01, AB0912DB-Z02, AB0912DB-Z03, AD0303DB-G53.  
Models AD0624MS-A70, AD0624HS-A7(A), AD0505H(B)-D70 series, where (A) may be 0 or 6, (B) may be B, S or X.  
Models AB0905HX-CB(X) series, where (X) may be 1 or 3.  
Models AD0312HX-G5(C) series, where (C) may be 0 or 6.  
Models AD1212(A)F-A7(C)GL, AD1012(B)B-F9(C) Series, where (A) may be U, H, M, L or D, (B) may be L or D, (C) may be 1, 2 or 3.  
Model AD0712(X)B-A7(Y)GP series, where (X) may be U, H, M or L, (Y) may be 1 or 3.  
Model AQ1212(X1)B-F5(Y1) series, where (X1) may be H, M or L, (Y1) may be 1, 2 or 3.  
Models AD1212(X)(Z)-A7(Y)GL, AD1224(X)(Z)-A7(Y)GL series, where (X) may be M, L or D, (Y) may be 0 or 6, (Z) may be B, S or X.  
Models AD0812(W)B-A7(Y)GP, AD0812(X)(Y)-A7(Z)GL series, where (V) may be 1 or 3, (W) may be V, X or U, (X) may be H or M, (Y) may be B, S or X, (Z) may be 9 or B.  
Models AB1012HB-LCB, AD1224(X)B-F9(Y)GP series, where (X) may be U, H, M, L or D, (Y) may be 1, 2, 3, 9 or B.  
Models AD0812D(X)-A78GL, AB5012(Y)B-A0(Z) series, where (X) may be B, S or X, (Y) may be H, M or L, (Z) may be 1 or 3.  
Models AD1212H(X)-A7(Y)GL, AD0412XB-G7(Y), AD0612(Z)B-A74GL series, where (X) may be B, S or X, (Y) may be 0 or 6, (Z) may be H or X.  
Models AD0605(X)(Y) D76GL, AD6512HB-TB(Z), AB0305H(P)-GA(U), AB0305MB-GA0, AB0305LB GA0, AB0305H(P)-GA(Z), AB0305MB GA(Z) series, where (X) may be H, M or L, (Y) may be B, S or X, (P) may be B or X, (Z) may be 1 or 3, (U) may be 0 or 6.  
Model AD0812U(X)-D7(Y) series, where (X) may be B, S or X, (Y) may be 1, 2 or 3.  
Models AD0912(W)(Z)-A7(Y)GL, AD0612X(Z)-A7(Y1)GL series, (W) may be H or M, (Y) may be 9 or B, (Y1) may be 1, 2 or 3, (Z) may be B, S or X.  
Models AB0705MX-EB3, AB7505MX-EB3, AB6812HB-A0B, AD5405LX-TB3, AP0405MB-G72.  
Model ADT848XB-N9B.  
Model AB0612HX-HC0.  
Model AQ7524UB.  
Model AB7805HX-EB3.  
Models AD0812(Y)B-F7(Z)DS, AD08(X)(S)B-F7(Z)DS, AD0912(Y)B-F9(Z)DS, AD09(X)(S)B-F9(Z)DS, AD0912(Y)B-F9(Z)GP, AD09(X)(S)B-F9(Z)GP series, where (X) may be 24 or 48, (Y) may be V, X, U or H, (S) may be X, U or H, (Z) may be 1, 3, 9 or B.  
Models AD0912(A)B-Y7(X)GL, AD1212(B)B-F9(Y)GP, AD1312(C)B-F5(Y), AD1324(D)B-F5(Y) series, where (A) may be M or L, (B) may be H, M, L or D, (C) may be X, U, H, M or L, (D) may be V, X, U, H, M or L, (X) may be 1, 2 or 3, (Y) may be 1, 2, 3, 9 or B.  
Model AD0812UB-D9(X) series, where (X) may be 1, 2 or 3.  
Models AD06(X)(Y)B-F7(Z)DS, AD0412(S)B-B5(B)GP, AD3812UB-B5(B)GP series, where (X) may be 12, 24 or 48, (Y) may be U, H or M, (Z) may be 1, 2, 3, 9 or B, (S) may be V, X, U, H or M, (B) may be 1, 2 or 3.  
Models AD4705MB-TB3, AB0805HX-EB3, AD0612U(Y)-D9(X), AB0612(W)B-A0(X), AD0812(T)B-A7(Z)GP series, where (T) may be V, X or U, (W) may be H, M or L, (X) may be 1, 2 or 3, (Y) may be B, S or X, (Z) may be B or 9.  
Model AD4412HB-EBB.  
Models AD0912LB-C7(X)GP, AD0612U(A)-C7(Y)GL series, where (A) may be B, S or X, (X) may be 1, 2 or 3, (Y) may be 6 or 0.  
Models AB0612UB-PB3, AB0512MB-GB3, AD4505HB-R03.  
Model AD4805HX-GD3.  
Models AB0805MX-EB3, ADN512(A)B-A9(B) series, where (A) may be X, U, H, M, L or D, (B) may be 1, 2 or 3.  
Models AD4512LX-D03, AD6512HB-TBB, AD0412(A)B-N5(B)DS, AD0412(C)B-B5(B)DS, AD3812(D)B-B5(B)DS, AD3812(E)B-B5(F)GP, AD0712(G)(H)-D7(I), AD0305HB-K70, AB0912UB-Z0(F) Series, where (A) may be X or U, (B) may be 1, 2, 3, 9 or B, (C) may be V, X, U or H, (D) may be V, X or U, (E) may be H or M, (F) may be 1, 2 or 3, (G) may be U, H, M, L or D, (H) may be B, S or X, (I) may be 9 or B.  
Models AD0712(E)B-D9(Z), AD0812(X)(Y)-D9(Z)GP, AD0812XB-D(V)GP series, where (E) may be H, M, L or D, (X) may be U, H, M or L, (Y) may be B, S or X, (Z) may be 1, 2 or 3, (V) may be 2 or 3.  
Models AB4705UB-CC3, AD0412(A)B-C5(D), AD17248XB25B(F)00, AD17224XB25B(F)00 Series, where (A) may be X or U, (D) may be 1, 2 or 3, (F) may be 1, 2, 3, 9 or B.  
Models AB3505MX-JB3, AD0205DX-K50, AD4805MB-GC3, AD5512H(A)-E0B, AD0805(X)(C)-C7(T), AD0612(Y)(C)-D9(U), AD0412(Z)B-B5(V)GP, AD1212U(C)-A7(U)GL series, where (A) may be B or X, (C) may be B, S or X, (T) may be 1, 2 or 3, (U) may be 0 or 6, (V) may be 9 or B, (X) may be H or M, (Y) may be H, M, L or D, (Z) may be V, X or U.  
Models AD4512MB-H03, AB6505HB-EB3, AB4512HX-GD7, AD0205MX-K53, AD1012(X)B-F9(V), AB7512(Y)B-W0(T), AD0805(Z)(U)-D7(P), AD0905DB-A7(V)GL series, where (U) may be B, S or X, (V) may be 1, 2 or 3, (P) may be 2 or 3, (T) may be 1, 2, 3, 9 or B, (Z) may be H or M, (Y) may be U, H, M, L or D, (X) may be U, M or H.  
Model AD0712XB-A7(X)GP series, where (X) may be 9 or B.  
Models AD1224(A)(B)-A7(C)GL, AD0912XB-A7(D)GL, AD0412EB-B57GP, AB0924(E)B-Z0(D) series, where (A) may be U or H, (B) may be B, S or X, (C) may be 0 or 6, (D) may be 1, 2 or 3, (E) may H, M or L.  
Models AB6105HB-RBB, AB6105HX-RBB, AB07012UB250300.  
Models AQ0912UB-Y73GL, AD0812VB-D7B, AD0812(A)(E)-D7B series, AD0912MB-U7BGL, AD1212U(E)-Y5(G) series, AD1212(D)(E)-F5(F) series, AD1224(D)(E)-F5(F) series, ADL312HB-X31, where (A) may be X, U, H, M, L or D, (D) may be H, M, L or D, (E) may be B, X or S, (F) may be 0 or 6, (G) may be 1, 2 or 3.  
Models AD0305HX-G00, AD4505HB-G03, AB05005HB10B(X)00 series, where (X) may be 1 or 3.  
Model AB7405(Y)X-LB3 series, where (Y) may be H or M.  
Model AG08012(X)(Y)257(Z)00, AG08012(X1)(Y)257(Z)00 series, where (X) may be U or H, (X1) may be M, L or D, (Y) may be B, S or X, (Z) may be 0 or 6.  
Models AB7205HB-HB3, AB7405HB-T03, AD0818XB-F7BDS, AD0824UB-Y51.  
Models AB7205HX-GC3, AB7205HX-GC1, AB0512MB-GB(D), AD0812(X)(Y)-D9(Z), AD0412UB-D5(Z), AD0412(V)(Y)-D5(D) series, where (D) may be 1 or 3, (X) may be U, H, M, L or D, (Y) may be B, S or X, (Z) may be 1, 2 or 3, (V) may be H, M or L.  
Models AB1805HX-S03, AB1705HX-S03, AB0905HX-S03, AB7505HX-S03, AD0312LX-K7(Z) series, where (Z) may be 1 or 3.  
Models AD4505HX-EB3, AD4605HX-EB3, AB7505HX-SB3, AB7505HX-LB3, AB7605HX-EB3, AD0612(X1)B-H9(Z1), AD5024(X2)(Y)-C7(Z1), AD12(V)(X3)(Y)-Y5(Z2) series, where (X1) may be U, H, M, L or D, (X2) may be U, H, M or L, (X3) may be H, M, L or D, (Y) may be B, S or X, (V) may be 12 or 24, (Z1) may be 1, 2 or 3, and (Z2) may be 0 or 6.  
Models AB7805HX-EB1, AD5005HX-RC1, AD0618UB F7BDS; Models AB7005(A1)X-ED3, AD5805(A1)X-ED3, AD0812(A2)(B) A7(C1)GL, AS12012(A3)B25A(C2)00, AS12024(A3)B25A(C2)00, AS12048(A3)B25A(C2)00 series, where (A1) may be H or M, (A2) may be X, L or D, (A3) may be U, H, M or L, (B) may be B, S or X, (C1) may be 9 or B, (C2) may be 1, 3, 9 or B.  
Model AD0612(B)X-H9(A) series, where (A) may be may be 1, 2 or 3, (B) may be U, H, M, L or D.  
Models AD0824XB-F72DS, AB0605HX-HE3, AY07012LX159000, AG08024(X1)(Y)257(Z1)00, AD0412XB-C7(Z2)GP, AD0924(X2)B-A7(X3)B-A7(Z2)GP, AD0812H(Y)-A7(Z1)GL series, where (X1) may be X, U or H, (X2) may be X or U, (X3) may be V, X, U or H, (Y) may be B, S or X, (Z1) may be 0 or 6, (Z2) may be 1, 2 or 3.  
Models AB06305HB10B300, AD0405HB-C5B, AD5005HB-D7B, AQ0912UB-Y7(X)GL series, where (X) may be 1 or 2.  
Marking: Company name or trademarks , or and model designation.Last Updated on 2008-05-29



GPWV8.E132139 Fans, Electric - Component  
 ADDA CORP E132139 NO 6 E SECTION INDUSTRY 6 RD PING TUNG, TAIWAN

Models AD08(A)(D)(C)-C70, AD09(A)(B)(C)-C70 series, where (A) may be 12 or 24, (B) may be H or M, (C) may be B or S, (D) may be B, S or X.

Models AD0205(A)(B)-(C)(D), AD0212(A)(B)-(C)(D), AD0305(A)(B)-(C)(D), AD0312(A)(B)-(C)(D), AD2005(A)(B)-(C)(D), AD2012(A)(B)-(C)(D) series, where (A) may be D, H, L or M, (B) may be B, S or X, (C) may be G, (D) may be 50 or 70.

Model AD2512HB-BV7.

Models AD04(A)(B)(C)-G70, AD0403L(C)-G70, AD0405(D)(C)-K96, AD0424(B)(C)-C70 series, where (A) may be 05 or 12, (B) may be H or M, (C) may be B, S or X, (D) may be H, L or M; Model BD0412MS-G70.

Model AD04(A), (B), (C), (D) or (E) series, where (A) may be 05, 12 or 24, (B) may be H, L or M, (C) may be B, S or X, (D) may be C or K, (E) may be 50, 51, 52, 53, 56 or C3.

Models AA128(A)(B)(C)-(D), AA838(A)(E)(C)-(F) series, where (A) may be 1 or 2, (B) may be D, H, L or M, (C) may be B, S or X, (D) may be AT, AW, PT or PW, (E) may be H or M, (F) may be AT or AW.

Model AD0612UB-D72GL.

Models AA1281U(A)-(B), AA1282U(A)-(B) series, where (A) may be B, S or X, (B) may be AT or AW.

Models AD0912H(A)-A70GL, AD0912M(A)-A70GL, AD0912H(A)-A71GL, AD0912M(A)-A71GL, AD0912L(A)-A71GL, AD0912H(A)-A72GL, AD0912M(A)-A72GL, AD0924H(A)-A70GL, AD0924M(A)-A70GL, AD0924L(A)-A70GL, AD0924H(A)-A71GL, AD0924M(A)-A71GL, AD0924L(A)-A71GL, AD0924H(A)-A72GL, AD0924M(A)-A72GL, AD0924L(A)-A72GL series, where (A) may be B, S or X.

Models AD0912(A)(Y)-A(W)GL, AD0912(A)(Y)-A2GL series, where (A) may be H, L, M or U, (Y) may be B, S or X, (W) may be 71, 72 or 73.

Models AD05(A)(B)(C)-(D), AD0505(E)(C)-G76, AD0512(E)(C)-(F), AD0512M(C)-D76, where (A) may be 05 or 12, (B) may be H or M, (C) may be B, S or X, (D) may be D70, D71 or G90, (E) may be H, L or M, (F) may be G70 or G76.

Models AD08(A)(B)(C)-D71, AD08(D)UB-A(E)GL, AD0812(B)B-D74, where (A) may be 05 or 12, (B) may be H or M, (C) may be B, S or X, (D) may be 12 or 24, (E) may be 71, 72 or 73.

Models AD06(A)(B)(C)-(E), AD06(A)(D)(C)-G90, AD0612(D)(C)-G96, where (A) may be 05 or 12, (B) may be H or M, (C) may be B, S or X, (D) may be H, L or M, (E) may be D71GL, D72GL or D73GL.

Models AD0305(D)(B)-G56, AD0312L(B)-G50, AD0405(A)(B)-C50, AD0412(B)(C)-C50, where (A) may be L or M, (B) may be B, S or X, (C) may be H, L or M, (D) may be D or L.

Models AD0405LX-K90, AD0405MX-K90, AD0412MX-K90, AD0512LX-G70, AD0512MX-G70, AD0612HY-D74GL, where (Y) may be B, S or X, (X) may be B or X.

Models AD08(A)(B)(D)-C70, AD09(A)(B)(C)-C70, where (A) may be 12 or 24, (B) may be H or M, (C) may be B or S, (D) may be B, S or X.

Model Atu05vw-xyz, where t may be B or D, u may be 03, 04, 05 or 45, v may be H, L or M, w may be B, S or X, x may be G or R, y may be 7, B or D, z may be 1, 3 or B.

Models AD2512(A), where (A) may be MB, MS or MX.

Model AD0812H(C)-A74GL, where (C) may be B, S or X.

Models AD0912H(A)-A70GL, AD0912M(A)-A70GL, AD0912H(A)-A71GL, AD0912M(A)-A71GL, AD0912L(A)-A71GL, AD0912H(A)-A72GL, AD0912M(A)-A72GL, AD0924H(A)-A70GL, AD0924M(A)-A70GL, AD0924L(A)-A70GL, AD0924H(A)-A71GL, AD0924M(A)-A71GL, AD0924L(A)-A71GL, AD0924H(A)-A72GL, AD0924M(A)-A72GL, AD0924L(A)-A72GL series, where (A) may be B, S or X.

Model AD12(X1)(X2)(X3)-F(X4), where (X1) may be 12, 24 or 48, (X2) may be H, L, M or U, (X3) may be B, S or X, (X4) may be 51, 52 or 53.

Model AD02(A)(L)(B)-G70, where (A) may be 05 or 12, (B) may be B, S or X; Model AD0205L(C)-G50, where (C) may be B or X.

Models AD0605M(C)-A70GL, AD0812H(C)-A74GL, where (C) may be B, X or S.

Model AD75(A)(B)(C), where (A) may be 12 or 24, (B) may be H or M, (C) may be B, S or X.

Models AD09(A)(H)(C)-A74GL, AD0912(B)(C)-A76GL, where (A) may be 12 or 24, (B) may be H, L or M, (C) may be B, S or X; Models AD4505H(B)-G70, AD4512(A)(B)-(C), where (A) may be H or M, (B) may be B, S or X, (C) may be G7 or G76.

Model AD0924XY-A7ZGL, where X may be U, H, M or L, Y may be X, B or S, Z may be 0, 1, 2 or 3.

Model AD1224(A)(B)-A74GL, where (A) may be H, L or M, (B) may be B, S or X.

Models AD0305L(X)-K70, AD0312L(X)-K70, where (X) may be B or X; Model AD0424MB-G70.

Models AD0412H(Y)-D50, AD0412H(Y)-D56, AD0412L(Y)-D50, AD0412L(Y)-D56, AD0412M(Y)-D50, AD0412M(Y)-D56, where (Y) may be B, S or X; Model AD0612M(B)-D70GL, where (B) may be B, S or X; Model AD0812MB-D76.

Model AD0612M(B)-D70GL, where (B) may be B, S or X; Model AD0812MB-D76; Models AD0612D(Y)-D70GL, AD0612D(Y)-D76GL, AD0612H(Y)-D70GL, AD0612H(Y)-A76GL, AD0612H(Y)-D76GL, AD0612L(Y)-D70GL, AD0612L(Y)-A76GL, AD0612L(Y)-D76GL, AD0612M(Y)-D70GL, AD0612M(Y)-A76GL, AD0612M(Y)-D76GL, AD0624H(Y)-D70GL, AD0624H(Y)-D76GL, AD0624M(Y)-D70GL, AD0624M(Y)-D76GL, where (Y) may be B, S or X.

Models AD0612H(Y)-A76GL, AD0612L(Y)-A76GL, AD0612M(Y)-A76GL, where (Y) may be B, S or X.

Model AD0624UX-A79GL.

Models AD0612XY-C72GL, AD0612XY-C73GL, AD0612XY-C76GL, AD0624XY-C70GL, AD0624XY-C76GL series, where X may be H, L or M, Y may be B, S or X.

Model AP45(A)(B)(C)-(D)(E), where (A) may be 05 or 12, (B) may be H, M or L, (C) may be B or X, (D) may be J or G, (E) may be 90 or 96.

Model AD(P1)(P2)(P3)(P4)-(P5), where (P1) may be 04, 05 or 45, (P2) may be 05, 12 or 24, (P3) may be L, M, H or U, (P4) may be B, X or S, (P5) may be 70 or 76.

Models AD02(A)(B)(C)-(D)(E), AD03(A)(B)(C)-(D)(E), AD35(A)(B)(C)-(D)(E), where (A) may be 05 or 12, (B) may be L, M and D, (C) may be B or X, (D) may be G or D, (E) may be 50 or 53.

Model AD(A)(B)(C)(D)-(E)(F), where (A) may be 02, 04, 05, 08, (B) may be 05, 12 or 24, (C) may be H, M or L, (D) may be S, X or B, (E) may be B, S or X, (F) may be 53, 70, 71, 72, 76.

Model ADabcd - efgh, where (a) may be 04, 06, 08 or 09, (b) may be 05, 12 or 48, (c) may be U, H, M or L, (d) may be B, S or X, (e) may be B, S or X, (f) may be 7, 9, A or C, (g) may be 0, 1, 3 or 6, (h) may be GL or blank.

Model AD(A)48H(B)-(C)(D)8(E), where (A) may be 08, 09 or 12, (B) may be B, S or X, (C) may be A or F, (D) may be 5 or 7, (E) may be GL or blank.

Model AD(A)24(B)(C)-A7(D)GL, where (A) may be 09 or 12, (B) may be H or M, (C) may be B, S or X, (D) may be 4 or A.

Model AD0505(A)(B)-G70, where (A) may be H, M or L, (B) may be B, S or X.

Models AD0524HB-G70, AD0524HS-G70, AD0524HX-G70, AD0524MB-G70, AD0524MS-G70, AD0524MX-G70, AD0524LB-G70, AD0524LS-G70, AD0524LX-G70, AD0524HB-G76, AD0524HS-G76, AD0524HX-G76, AD0524MB-G76, AD0524MS-G76, AD0524MX-G76, AD0524LB-G76, AD0524LS-G76, AD0524LX-G76, AD0612UB-A71GL, AD0612US-A71GL, AD0612UX-A71GL, AD0612UB-A72GL, AD0612US-A72GL, AD0612UX-A72GL, AD0612UB-A73GL, AD0612US-A73GL, AD0612UX-A73GL.

Models AD0412UBC50, AD0412UBC52, AD0412UBC56, AD0412UBD50, AD0412UBD52, AD0412UBD56, AD0412USC50, AD0412USC52, AD0412USC56, AD0412USD50, AD0412USD52, AD0412USD56, AD0412UXC50, AD0412UXC52, AD0412UXC56, AD0412UXD50, AD0412UXD52, AD0412UXD56, AD0412HBC50, AD0412HBC52, AD0412HBC56, AD0412HBD50, AD0412HBD52, AD0412HBD56, AD0412HSC50, AD0412HSC52, AD0412HSC56, AD0412HSD50, AD0412HSD52, AD0412HSD56, AD0412HXC50, AD0412HXC52, AD0412HXC56, AD0412HXD50, AD0412HXD52, AD0412HXD56, AD0412MBC50, AD0412MBC52, AD0412MBC56, AD0412MBD50, AD0412MBD52, AD0412MBD56, AD0412MSC50, AD0412MSC52, AD0412MSC56, AD0412MSD50, AD0412MSD52, AD0412MSD56, AD0412MXC50, AD0412MXC52, AD0412MXC56, AD0412MXD50, AD0412MXD52, AD0412MXD56, AD0412LBC50, AD0412LBC52, AD0412LBC56, AD0412LBD50, AD0412LBD52, AD0412LBD56, AD0412LSC50, AD0412LSC52, AD0412LSC56, AD0412LSD50, AD0412LSD52, AD0412LSD56, AD0412LXC50, AD0412LXC52, AD0412LXC56, AD0412LXD50, AD0412LXD52, AD0412LXD56.

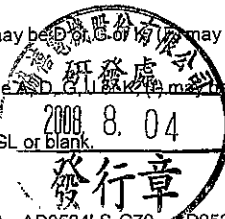

Model AD0612HB-D78GL.

Models AD0812UB-A70GL, AD0812US-A70GL, AD0812UX-A70GL, AD0812UB-A76GL, AD0812US-A76GL, AD0812UX-A76GL, AD0812HB-A76GL, AD0812HS-A76GL, AD0812HX-A76GL, AD0812MB-A76GL, AD0812MS-A76GL, AD0812MX-A76GL, AD0812LB-A76GL, AD0812LS-A76GL, AD0812LX-A76GL, AD0912UB-A70GL, AD0912US-A70GL, AD0912UX-A70GL, AD0912UB-A76GL, AD0912US-A76GL, AD0912UX-A76GL, AD0912DB-A70GL, AD0912DS-A70GL, AD0912DX-A70GL, AD0612HB-G70, AD0612HS-G70, AD0612HX-G70, AD0612MB-G70, AD0612MS-G70, AD0612MX-G70, AD0612LB-G70, AD0612LS-G70, AD0612LX-G70, AD0612HB-G76, AD0612HS-G76, AD0612HX-G76, AD0612MB-G76, AD0612MS-G76, AD0612MX-G76, AD0612LB-G76, AD0612LS-G76, AD0612LX-G76, AD0312MX-G50.

Models AD0305MB-G53, AP0412MX-C70.

Models AD1212UB-F51, AD1212US-F51, AD1212UX-F51, AD1212UB-F52, AD1212US-F52, AD1212UX-F52, AD1212UB-F53, AD1212US-F53, AD1212UX-F53.

Models AB5012HB-C06, AD7512LB, AD7512LS, AD7512LX, AD7512UB, AD7512UX, AD7524LB, AD7524LS, AD7524LX, AD7524UB, AD7524US, AD7524UX.

Models AD0505HX-RBB, AD0505HX-RB0.

Models AD0712HB-A70GL, AD0712HS-A70GL, AD0712HX-A70GL, AD0712MB-A70GL, AD0712MS-A70GL, AD0712MX-A70GL, AD0712LB-A70GL, AD0712LS-A70GL, AD0712LX-A70GL, AD0712HB-A76GL, AD0712HS-A76GL, AD0712HX-A76GL, AD0712MB-A76GL, AD0712MS-A76GL, AD0712MX-A76GL, AD0712LB-A76GL, AD0712LS-A76GL, AD0712LX-A76GL.

Models AA1752HB-AW, AA1752HB-AT.

Models AD0712(A)(B)-DA(C), where (A) may be U, H, M, L or D, (B) may be B, S or X, (C) may be 0 or 6.

Model AA1751(X)B-A(Y), where (X) may be H or M, (Y) may be T or W; Models AD0405(A)(B)-G(C), AD0412(A)(B)-G(C), where (A) may be H, M or L, (B) may be B, S or X, (C) may be 71, 72 or 73.

Model AD0205(A)(B)-Q53, where (A) may be M, L or D, (B) may be B or X.

Model AD4505MX-RB3.

Model AD0405(A)(B)-GA3, where (A) may be H or M, (B) may be B or X.

Model AD12(A)(B)(C)-A7(D)GL, where (A) may be 12 or 24, (B) may be H, M, L or U, (C) may be B, S or X, (D) may be 1, 2 or 3.

Model AD1224XB-A7(D)GL series, where (D) may be 1, 2 or 3.

Models AD5012(A)(B)-D7(C), where (A) may be H, M, L or U, (B) may be B, S or X, (C) may be 0 or 6.

Models AD0812(A)(B)-C7(D), AD0824(C)(B)-C7(D), where (A) may be U, H, M or L, (B) may be B, S or X, (C) may be H or M, (D) may be 0 or 6.

Models AD2005LB-G73, AB0405HB-G03.

Model AB7005(A)B-SA3, where (A) may be H, M or L.

Model AD12(A)(B)(C)-(D)(E)(F), where (A) may be 12 or 24, (B) may be U, H, M, L or D, (C) may be B, S or X, (D) may be Y or A, (E) may be 51, 52, 53, 74 or 7A, (F) may be GL or blank.

Models AE1281B, AE1281S, AE1281X.

Model AD0812(A)(B)-D7(C), where (A) may be H, M or L, (B) may be B, S or X, (C) may be 1 or 3.

AC fans, Models AA1282(X)(Y)-A(Z)GL, AA1282(X)(Y)-A(Z)GL5, AA1252M(Y)-A(Z)GL, where (X) may be H, M, L or D, (Y) may be B, X or S, (Z) may be T or W.

Model AA1251M(X)-A(Y)GL series, where (X) may be B or S, (Y) may be T or W.

Models AK8251HB, AK8252HB, AK9251HB, AK9252HB, AK1281HB, AK1282HB, AK1751HB, AK1752HB, AK8251MB, AK8251LB, AK8381HB, AK8381MB, AK8381LB, AK9251MB, AK9251LB, AK9381HB, AK9381MB, AK9381LB, AK1251HB, AK1251MB, AK1251LB, AK1281MB, AK1281LB, AK8252MB, AK8252LB, AK8382MB, AK8382LB, AK9252MB, AK9252LB, AK9382HB, AK9382MB, AK9382LB, AK1252HB, AK1252MB, AK1252LB, AK1282MB, AK1282LB, AK1651HB, AK1651MB, AK1651LB, AK1751MB, AK1751LB, AK2071HB, AK2581HB, AK2581MB, AK1652HB, AK1652MB, AK1652LB, AK1752MB, AK1752LB, AK2072HB, AK2582HB, AK2582MB, AK1781HB, AK1782HB, AK1861HB, AK1862HB.

Models AA1751(X)B-A(Y)SC, AA1752(X)B-A(Y)SC series, where (X) may be H, M or L, (Y) may be T or W; Models AA2072HB-AWSC, AA2582HB-AWSC.

Models AX25892LB, AX25891LB, AX17382HB, AX17381HB, AX25891HB, AX25891MB.

DC fans, Models AD0405UB-GA3, AD0405UX-GA3, AD0612(X)B-D9(Y), where (X) may be U or H, (Y) may be 1, 2 or 3.

Model AD0305(X)(Y)-Q7(Z), where (X) may be H, M or L, (Y) may be B or X, (Z) may be 1 or 3.

Model AD0624(X)(Y)-A7(Z)GL, where (X) may be U, H or M, (Y) may be B, X or S, (Z) may be 1, 2 or 3.

Models AD5105HB-L06, AD4605HB-GC3.

Models AD0605(X)(Y)-D7(Z)GL, AD0605(P)(Y)-A7(Z)GL, where (X) may be U, H, M or L, (Y) may be B, S or X, (Z) may be 1, 2 or 3, (P) may be H, M or L.

Model AD0848H(X)-A7(Y)GL, where (X) may be B, S or X, (Y) may be 0 or 6.

Model AB0405UB-G03.

Model AD0412(A)(B)-B3(C), where (A) may be H, M or L, (B) may be B, S or X, (C) may be 1, 2 or 3.

Models AD0924XB-A71GL, AD0924XB-A72GL, AD0924XB-A73GL.

Models AB3505HB-QB3, AB0605HB-E03, AD2705HB-Q73, AD4505HB-H03.

Models AB7012HB-E01, AB7012HB-E02, AB7012HB-E03.

Models AB6812HX-GC0, AB6812MX-GC0, AB6812LX-GC0.

Models AB7005HB-E0(X), AB6105HB-DC(X), where (X) may be 1, 2 or 3.

Model AB0605(A)(B)-E0(C), where (A) may be H or M, (B) may be B, S or X, (C) may be 1, 2 or 3.

Model AP5212(X)(Y)-E7(Z), where (X) may be H, M, L or D, (Y) may be X or B, (Z) may be 0 or 6.

Models AB4805HB-L03, AB5505M(A)-GD(B), where (A) may be B or X, (B) may be 1, 2 or 3.

Model AB3512(X)(Y)-QB(Z), where (X) may be U, H, M or L, (Y) may be B or X, (Z) may be 0 or 6.

Models AB4505H(A)-GD(B), AB4505M(A)-GD(B), AB4505L(A)-GD(B), AD4505HB-T0(B), AD0605DB-D9(B), AD0712UB-D9(B), AB4512(X)(D)-QA(C), AD5012(X)(A)-D7(B), where (A) may be B, S or X, (B) may be 1, 2 or 3, (X) may be H, M or L, (D) may be B or X, (C) may be 0 or 6.

Models AD0424(B)(Y)-D5(U), AD0612LS-D90, AD0612(X)(Y)-D7(Z)GL, AD0812(A)(Y)-A7(Z)GL, AD0812HS-A70GL, AD0424(B)(Y)-C5(Z), where (A) may be X, U, H, M, L or D, (B) may be H, M or L, (X) may be U, H, M, L or D, (Y) may be B, S or X, (U) may be 0 or 6, (W) may be 1 or 2, (Z) may be 1, 2 or 3.

Models AD5012HB-S01, AD5012HB-S02, AD5012HB-S03.

Model AD0812H(X)-A78GL, where (X) may be B, S or X.

Model AD0848HB-A7(X)GL, where (X) may be 1, 2 or 3.

Model AD0205(X)(Y)-G50, where (X) may be H, M, L or D, (Y) may be B or X.

Model AB3505(X)(Y)-QB0, where (X) may be H, M or L, (Y) may be B or X.

Model AD0605HB-TB(X), where (X) may be 1, 2 or 3.

Models AD0512(X)X-RB(Y), AD0512(X)B-RB(Y), where (X) may be H or M, (Y) may be 0 or 6.

Models AD0412UB-G7(Y), AD0412D(Z)-G7(Y), AB0605HB-TB(X), where (X) may be 1, 2 or 3, (Y) may be 0 or 6, (Z) may be B, S or X.

Models AB3505(X)B-GA(Z), AB3505(X)X-GA(Z), AB5012(X)(Y)-C0(W), AD0812U(Y)-C7(W), AD0812(X)(Y)-C7(W), AD0812D(Y)-C7(W), AD0812UB-F7(W), AD0812(X)(Y)-F7(W), AD0812D(Y)-F7(W), where (X) may be H, M or L, (Y) may be B, S or X, (Z) may be 0 or 6, (W) may be 1, 2 or 3.

Model AD0612M(X)-GA0, where (X) may be S, X or B.

Model AD5512HB-SC(X), where (X) may be 1, 2 or 3.

Model AD3505(X)(Y)-G5(Z), where (X) may be H, M or L, (Y) may be B or X, (Z) may be 1 or 2.

Models AD0824H(X)-A7(Y)GL, AD0824H(X)-A7(Y)GL, AB0912MB-Z0(Z), AB0912LB-Z0(Z), where (X) may be B, S or X, (Y) may be A, 4 or 8, (Z) may be 1, 2 or 3.

Models AD0612(X)(Y)-GA(Z), AD0712(W)(Y)-D7(Z), where (X) may be H, M or L, (W) may be M, L or D, (Y) may be B, S or X, (Z) may be 0 or 6.

Models AB0812HB-C03, AB6812HB-A03, AB7312HB-M03.



Models AD0305(X)(A)-D50, AD0312(X)(A)-D50, AD3503HB-G52, AD0712U(Y)-A7(W)GL, AD0712(X)(Y)-A7(W)GL, AD0712(X)B-DA(W), AD0712DB-DA(W), AD0812D(Y)-A7(Z)GL, (A) may be B or X, where (X) may be H, M or L, (Y) may be B, S or X, (Z) may be 0 or 6, (W) may be 1, 2 or 3.

Models AD0712U(X)-A7(Y)GP, AD0712H(X)-A7(Y)GP, AD0812U(X)-A7(Y)GL, AD0912U(X)-A7(Y)GL, where (X) may be B, X or S, (Y) may be B or 9.

Models AD0405HB-GD(W), AD0505HB-C0(W), AB4512(X)(Y)-GD(Z), where (X) may be H, M or L, (Y) may be B, S or X, (W) may be 1, 2 or 3, (Z) may be 0 or 6.

Models AQ0(X)(Y)(A)B-A7(Z)GL, AQ0(X)(Y)(B)B-A7(W)GL, where (X) may be 8 or 9, (Y) may be 12 or 24, (A) may be H, M or L, (B) may be M or L, (Z) may be 1, 2 or 3, (W) may be 0 or 6.

Models AB0712HB-CC1, AB0712HB-CC2, AB0712HB-CC3.

Models AD3512(X)(Y)-G5(W), AD0505(X)(Z)-G7(W), AD0512(X)(Z)-G7(W), where (X) may be H, M or L, (Y) may be B or X, (W) may be 1, 2 or 3, (Z) may be B, S or X.

Models AD0712(Y)F-D9(A), AD0812(W)F-A7(A)GL, AD0812MF-A7(B)GL, AD0812LF-A7(B)GL, AD0724(Z)F-D9(A), AD0824(X)F-A7(A)GL, AD0824MF-A7(B)GL, AD0824LF-A7(B)GL, where (Y) may be H, M, L or D, (A) may be 1, 2 or 3, (W) may be U, H, M or L, (Z) may be U, H, M, L or D, (X) may be X, U, H, M or L, (B) may be 0 or 6.

Models AD0612XB-D7(W)GL, AD0912UB-Y7(Y)GL, AD0912H(Z)-C7(W), AD0912M(Z)-C7(W), where (W) may be 1, 2 or 3, (Y) may be B or 9, (Z) may be B, S or X.

Models AB6505HB-LB(A), AB5505HB-LB(A), AB7405HB-HB(A), AB0605HB-HB(A), AD0612HB-D0(A), where (A) may be 1 or 3.

Model AB7605HB-HB3.

Models AD3705HB-JA(A), AD5505HB-LC(X), AD5512HB-LC(X), AB0812LB-PB(X), where (X) may be 1, 2 or 3, (A) may be 1 or 3.

Model AD0405HB-GB(A), where (A) may be 1 or 3.

Models AD1212(Z)(Y)-A7(A)GL, AD0412UB-B3(A), AD0812(X)B-Y5(A), AD0612(W)F-D7(A)GL, AD0912(W)F-A7(A)GL, AD1212UX-F57, AD1224UX-F57, where (Z) may be X or D, (Y) may be B, S or X, (X) may be X, U, H, M or L, (W) may be M, L or D, (A) may be 1, 2 or 3.

Models AD0305HB-K9(A), AB1205HB-CB(A), AD0712U(B)-D9(C), AD5012U(B)-D7(A), where (A) may be 1, 2 or 3, (B) may be B, S or X, (C) may be B or 9.

Models AD0612XB-C7(A)GL, AD1212(U)(Y)-A7(B)GL, where (A) may be 1, 2 or 3, (U) may be U, H, M, L or D, (Y) may be B, S or X, (B) may be B or 9.

Models AD0605HB-GC(Y), AB0605H(X)-EB(Y), AB0605U(X)-TB(Y), where (X) may be B or X, (Y) may be 1 or 3.

Models AP3505(U)(W)-J70, AP3512(U)(W)-J70, AD1248(V)(X)-A7(Y)GL, AD0512(V)B-TB(Z), AP0812LS-A00GL, where (U) may be H, M or L, (W) may be B or X, (V) may be U or H, (X) may be B, S or X, (Y) may be 1, 2 or 3, (Z) may be 1 or 3.

Model AB3512(X)(Y)-GA0, where (X) may be H, M or L, (Y) may be B or X.

Models AB0612D(A)-TB(B), AD5024(C)(A)-D7(B), where (A) may be B, S or X, (B) may be 1, 2 or 3, (C) may be V, X, U, H or M.

Models AD4505HB-GB(A), AB8505HB-VB(A), AB0805HB-CB(A) series, where (A) may be 1, 2 or 3.

Models AD4512HB-E0(Y), AB0912UB-Y0(Y), AD0612VB-A7(Y)GP series, where (Y) may be 1, 2 or 3.

Models AD0612U(X)-C7(Y)GL, AD0612(W)(X)-C7(Y)GL, AD0912(W)B-Z7(Z)GL series, where (X) may be B, S or X, (Y) may be 1, 2 or 3, (Z) may be B or 9, (W) may be H, M, L or D.

Models AA8251(A)(B)-A(C), AA8252(A)(B)-A(C), AA9251(A)(B)-A(C), AA9252(A)(B)-A(C), AA1251M(B)-A(C), AA1252M(B)-A(C) series, where (A) may be H or M, (B) may be S or B, (C) may be T or W.

Models AD1212UB-A3(Y)GL, AD1212DB-A9(Y), AB0512H(X)-RB0, AB0512M(X)-RB0, AB0512L(X)-RB0, AB0512H(X)-RB6, AB0512M(X)-RB6, AB0512L(X)-RB6 series, where (X) may be B, S or X, (Y) may be 1, 2 or 3.

Models AD0712(Z)(X)-D7(Y), AB1212XB-Y0(Y), AB1212(Z)(X)-Y0(Y), AB1224XB-Y0(Y), AB1224(Z)(X)-Y0(Y) series, where (Z) may be U, H, M, L or D, (X) may be B, S or X, (Y) may be 1, 2 or 3.

Models AD0414MB-G74, AB0612HX-T0(Y), AD4505MB-H0(Y), AD3512H(M)(X)-K7(Y) series, where (X) may be B or X, (Y) may be 1, 2 or 3.

Models AD0605HB-EB(X), AB0705HB-EB(X), AD4805HB-TB(X), AD6505HB-GC(Y) series, where (X) may be 1, 2 or 3, (Y) may be 9 or B.

Models AD0424(Y)B-B3(X), AB0912HB-W0(X) series, where (Y) may be H, M or L, (X) may be 1, 2 or 3.

Models AQ0948HB-A71GL, AQ0948MB-A71GL.

Models AD8505HB-GC(X) series, where (X) may be 9 or B.

Models AD1224(A)(C)-Y5(D), AD1248(B)(C)-Y5(D) series, where (A) may be U, H, M, L or D, (B) may be U, H or M, (C) may be B, S or X, (D) may be 1, 2 or 3.

Models AD0405HB-HB(Y), AD0605HB-LB(Y), AD5405HB-TB(Y), AB6805HB-GB(Y), AD5012U(D)-C7(Y), AD5012H(D)-C7(Y), AD5012M(D)-C7(Y), AD5012L(D)-C7(Y) series, where (D) may be B, S or X, (Y) may be 1, 2 or 3.

Model AD0612(X)B-A7(Y)GP series, where (X) may be X, U, H, M, L or D, (Y) may be 1, 2 or 3.

Model AD0612(X)B-A7(Y)GP series, where (X) may be X, U, H, M, L or D, (Y) may be 1, 2 or 3.

Models AD0205H(X)-K50, AD0205M(X)-K50, AD0205L(X)-K50, AD0205D(X)-K50, AD0212H(X)-K50, AD0212M(X)-K50, AD0212L(X)-K50, AD0212D(X)-K50, AB4505M(X)-GA0, AB4505L(X)-GA0, AB4505M(X)-GA6, AB4505L(X)-GA6, AB4512H(X)-GA0, AB4512M(X)-GA0, AB4512L(X)-GA0, AB4512H(X)-GA6, AB4512M(X)-GA6, AB4512L(X)-GA6 series, where (X) may be B or X.

Models AD4512(A)B-G7(D), AD4512(B)(C)-G7(D), AD5805HX-TB(D), AB0612HX-HC(D) series, where (A) may be X or U, (B) may be H, M or L, (C) may be B, S or X, (D) may be 1, 2 or 3.

Models AD1212(A)(C)-F5(D), AD1224(A)(C)-F5(D), AD1248(A)(C)-F5(D), AD2512(B)(C) series, where (A) may be U, H, M, L or D, (B) may be M or L, (C) may be B, S or X, (D) may be 1, 2 or 3.

Model AD0912LB-U7BGL.

Model AB6505HB-HB(Y) series, where (Y) may be 1, 2 or 3.

Models AD0912XB-Y7BGL, AD0912XB-Y79GL.

Model AD1212X(B)-A7(C)GL series, where (B) may be B, S or X, (C) may be B or 9.

Models AB7505HB-HB(X), AB0705HB-HB(X) series, where (X) may be 1, 2 or 3.

Models AD0912UB-Y7(X)GL series, where (X) may be 1, 2 or 3.

Model AB0712HB-CB(X) series, where (X) may be 1 or 3.

Model AQ1212(X)B-Y7(Y)GL series, where (X) may be H, M, L or D, (Y) may be 1, 2 or 3.

Models AD0612M(W)-D9(X), AD0312H(Y)-K70, AD0312L(Y)-K70, AD1348(C)B-F5(Z) series, AD0312MX-K70, where (C) may be V, X, U, H, M or L, (W) may be B, S or X, (X) may be 1, 2 or 3, (Y) may be B or X, (Z) may be 1, 2, 3, 9 or B.

Models AD0424H(A)-G7(C), AD0424M(A)-G7(C), AD0424L(A)-G7(C), AD5605HB-TB(C) series, where (A) may be B, S or X, (C) may be 1, 2 or 3.

Model AD0605(A)(B)-C7(C)GL series, where (A) may be H, M or L, (B) may be B, S or X, (C) may be 0 or 6.

Model AB5605HB-RBB.

Models AD0612UX-A70GL, AD0612UX-A76GL.

Models AD0412MX-K90, AD0405HB-GC(Y) series, where (Y) may be 1, 2 or 3.

Models AB0705HX-TB3, AB0605UB-HB3, AB0512(X)(Z)-RB(Y) series, where (X) may be H, M or L, (Y) may be 1, 2 or 3, (Z) may be B, S or X.

Models AB0612HB-PB3, AD5405HX-TB3, AB0405(X)B-GC(Y) series, where (X) may be H, M or L, (Y) may be 1, 2 or 3.

Models AD3012MB-K70, AD0824M(X)-A7(Y)GL, AD1248(A)B-F9(Z)GP series, where (X) may be B, S or X, (Y) may be 0 or 6, (A) may be U, H, M, L or D, (Z) may be 1, 2, 3, 9 or B.

Models AB0705HX-LB3, AB0705HX-HB3, AB7505HX-HB3, AB7505UX-EB3.

Models AD0624H(B)-A7(C)GL series, AB6505HX-TB3, AB0705HX-EB3, where (B) may be B, S or X, (C) may be 0 or 6.

Models AD0812HB-C71GP, AD0812U(X)-C7(Z)GL series, where (X) may be B or X, (Z) may be 1, 2 or 3; Model AB7505HX-EB3.

Models AD0412UB-G71, AD0412UB-G72, AD0412UB-G73, AD0412US-G71, AD0412US-G72, AD0412US-G73, AD0412UX-G71, AD0412UX-G72, AD0412UX-G73, AD0612UB-A7BGL, AD0612UB-A79GL, AD0612US-A7BGL, AD0612US-A79GL, AD0612UX-A7BGL, AD0612UX-A79GL.

Model AD0312HB-G5(X) series, where (X) may be 0 or 6.

Models AB0705(Z)X-HB3, AB0505HX-HC3, AD0912UB-A7(Y)GP, AD6512UB-TB6 series, where (Y) may be 1, 2 or 3, (Z) may be U or M.



Models AD0824US-A7(Y)GL series, where (Y) may be 1, 2 or 3.  
Model AD0812XB-D91GP.  
Models AD0412UB-C7(B)GP, AD0412HB-C7(B)GP, AD0412MB-C7(B)GP, AD0412LB-C7(B)GP, AB0705HX-HC(C) series, where (B) may be 1, 2 or 3, (C) may be 1 or 3.  
Models AB0912DB-Z01, AB0912DB-Z02, AB0912DB-Z03, AD0303DB-G53.  
Models AD0624MS-A70, AD0624HS-A7(A), AD0505H(B)-D70 series, where (A) may be 0 or 6, (B) may be B, S or X.  
Models AB0905HX-CB(X) series, where (X) may be 1 or 3.  
Models AD0312HX-G5(C) series, where (C) may be 0 or 6.  
Models AD1212(A)F-A7(C)GL, AD1012(B)B-F9(C) series, where (A) may be U, H, M, L or D, (B) may be L or D, (C) may be 1, 2 or 3.  
Model AD0712(X)B-A7(Y)GP series, where (X) may be U, H, M or L, (Y) may be 1 or 3.  
Model AQ1212(X1)B-F5(Y1) series, where (X1) may be H, M or L, (Y1) may be 1, 2 or 3.  
Models AD1212(X)Z-A7(Y)GL, AD1224(X)Z-A7(Y)GL series, where (X) may be M, L or D, (Y) may be 0 or 6, (Z) may be B, S or X.  
Models AD0812(W)B-A7(V)GP, AD0812(X)Y-A7(Z)GL series, where (V) may be 1 or 3, (W) may be V, X or U, (X) may be H or M, (Y) may be B, S or X, (Z) may be 9 or B.  
Models AD0812D(X)-A78GL, AB5012(Y)B-A0(Z) series, where (X) may be B, S or X, (Y) may be H, M or L, (Z) may be 1 or 3.  
Models AD1212H(X)-A7(Y)GL, AD0412XB-G7(Y), AD0612(Z)B-A74GL series, where (X) may be B, S or X, (Y) may be 0 or 6, (Z) may be H or X.  
Models AD0605(X)(Y) D76GL, AD6512HB-TB(Z), AB0305H(P)-GA(U), AB0305MB-GA0, AB0305LB GA0, AB0305H(P)-GA(Z), AB0305MB GA(Z) series, where (X) may be H, M or L, (Y) may be B, S or X, (P) may be B or X, (Z) may be 1 or 3, (U) may be 0 or 6.  
Model AD0812U(X)-D7(Y) series, where (X) may be B, S or X, (Y) may be 1, 2 or 3.  
Models AD0912(W)Z-A7(Y)GL, AD0612X(Z)-A7(Y1)GL series, (W) may be H or M, (Y) may be 9 or B, (Y1) may be 1, 2 or 3, (Z) may be B, S or X.  
Models AB0705MX-EB3, AB7505MX-EB3, AB6812HB-A0B, AD5405LX-TB3, AP0405MB-G72.  
Model ADT848XB-N9B.  
Model AB0612HX-HC0.  
Model AQ7524UB.  
Model AB7805HX-EB3.  
Models AD0812(Y)B-F7(Z)DS, AD08(X)(S)B-F7(Z)DS, AD0912(Y)B-F9(Z)DS, AD09(X)(S)B-F9(Z)DS, AD0912(Y)B-F9(Z)GP, AD09(X)(S)B-F9(Z)GP series, where (X) may be 24 or 48, (Y) may be V, X, U or H, (S) may be X, U or H, (Z) may be 1, 3, 9 or B.  
Models AD0912(A)B-Y7(X)GL, AD1212(B)B-F9(Y)GP, AD1312(C)B-F5(Y), AD1324(D)B-F5(Y) series, where (A) may be M or L, (B) may be H, M, L or D, (C) may be X, U, H, M or L, (D) may be V, X, U, H, M or L, (X) may be 1, 2 or 3, (Y) may be 1, 2, 3, 9 or B.  
Model AD0812UB-D9(X) series, where (X) may be 1, 2 or 3.  
Models AD06(X)(Y)B-F7(Z)DS, AD0412(S)B-B5(B)GP, AD3812UB-B5(B)GP series, where (X) may be 12, 24 or 48, (Y) may be U, H or M, (Z) may be 1, 2, 3, 9 or B, (S) may be V, X, U, H or M, (B) may be 1, 2 or 3.  
Models AD4705MB-TB3, AB0805HX-EB3, AD0612U(Y)-D9(X), AB0612(W)B-A0(X), AD0812(T)B-A7(Z)GP series, where (T) may be V, X or U, (W) may be H, M or L, (X) may be 1, 2 or 3, (Y) may be B, S or X, (Z) may be B or 9.  
Model AD4412HB-EBB.  
Models AB0612UB-PB3, AB0512MB-GB3, AD4505HB-R03.  
Models AD0912LB-C7(X)GP, AD0612U(A)-C7(Y)GL series, where (A) may be B, S or X, (X) may be 1, 2 or 3, (Y) may be 6 or 0.  
Model AD4805HX-GD3.  
Models AB0805MX-EB3, ADN512(A)B-A9(B) series, where (A) may be X, U, H, M, L or D, (B) may be 1, 2 or 3.  
Models AD4512LX-D03, AD6512HB-TBB, AD0412(A)B-N5(B)DS, AD0412(C)B-B5(B)DS, AD3812(D)B-B5(B)DS, AD3812(E)B-B5(F)GP, AD0712(G)(H)-D7(I), AD0305HB-K70, AB0912UB-Z0(F) series, where (A) may be X or U, (B) may be 1, 2, 3, 9 or B, (C) may be V, X, U or H, (D) may be V, X or U, (E) may be H or M, (F) may be 1, 2 or 3, (G) may be U, H, M, L or D, (H) may be B, S or X, (I) may be 9 or B.  
Models AD0712(E)B-D9(Z), AD0812(X)(Y)-D9(Z)GP, AD0812XB-D(V)GP series, where (E) may be H, M, L or D, (X) may be U, H, M or L, (Y) may be B, S or X, (Z) may be 1, 2 or 3, (V) may be 2 or 3.  
Models AB4705UB-CC3, AD0412(A)B-C5(D), AD17248XB25B(F)00, AD17224XB25B(F)00 Series, where (A) may be X or U; (D) may be 1, 2 or 3; (F) may be 1, 2, 3, 9 or B.  
Models AB3505MX-JB3, AD0205DX-K50, AD4805MB-GC3, AD5512H(A)-E0B, AD0805(X)(C)-C7(T), AD0612(Y)(C)-D9(U), AD0412(Z)B-B5(V)GP, AD1212U(C)-A7(U)GL series, where (A) may be B or X, (C) may be B, S or X, (T) may be 1, 2 or 3, (U) may be 0 or 6, (V) may be 9 or B, (X) may be H or M, (Y) may be H, M, L or D, (Z) may be V, X or U.  
Models AD4512MB-H03, AB6505HB-EB3, AB4512HX-GD7, AD0205MX-K53, AD1012(X)B-F9(V), AB7512(Y)B-W0(T), AD0805(Z)(U)-D7(P), AD0905DB-A7(V)GL series, where (U) may be B, S or X, (V) may be 1, 2 or 3, (P) may be 2 or 3, (T) may be 1, 2, 3, 9 or B, (Z) may be H or M, (Y) may be U, H, M, L or D, (X) may be U, M or H.  
Model AD0712XB-A7(X)GP series, where (X) may be 9 or B.  
Models AD1224(A)B-A7(C)GL, AD0912XB-A7(D)GL, AD0412EB-B57GP, AB0924(E)B-Z0(D) series, where (A) may be U or H, (B) may be B, S or X, (C) may be 0 or 6, (D) may be 1, 2 or 3, (E) may H, M or L.  
Models AB6105HB-RBB, AB6105HX-RBB, AB07012UB250300.  
Models AQ0912UB-Y73GL, AD0812VB-D7B, AD0812(A)(E)-D7B series, AD0912MB-U7BGL, AD1212U(E)-Y5(G) series, AD1212(D)(E)-F5(F) series, AD1224(D)(E)-F5(F) series, ADL312HB-X31, where (A) may be X, U, H, M, L or D, (D) may be H, M, L or D, (E) may be B, X or S, (F) may be 0 or 6, (G) may be 1, 2 or 3.  
Models AD0305HX-G00, AD4505HB-G03, AB05005HB10B(X)00 series, where (X) may be 1 or 3.  
Model AB7405(Y)X-LB3 series, where (Y) may be H or M.  
Model AG08012(X)(Y)257(Z)00, AG08012(X1)(Y)257(Z)00 series, where (X) may be U or H, (X1) may be M, L or D, (Y) may be B, S or X, (Z) may be 0 or 6.  
Models AB7205HB-HB3, AB7405HB-T03, AD0818XB-F7BDS, AD0824UB-Y51.  
Models AB7205HX-GC3, AB7205HX-GC1, AB0512MB-GB(D), AD0812(X)(Y)-D9(Z), AD0412UB-D5(Z), AD0412(V)(Y)-D5(D) series, where (D) may be 1 or 3, (X) may be U, H, M, L or D, (Y) may be B, S or X, (Z) may be 1, 2 or 3, (V) may be H, M or L.  
Models AB1805HX-S03, AB1705HX-S03, AB0905HX-S03, AB7505HX-S03, AD0312LX-K7(Z) series, where (Z) may be 1 or 3.  
Models AD4505HX-EB3, AD4605HX-EB3, AB7505HX-SB3, AB7505HX-LB3, AB7605HX-EB3, AD0612(X1)B-H9(Z1), AD5024(X2)(Y)-C7(Z1), AD12(V)(X3)(Y)-Y5(Z2) series, where (X1) may be U, H, M, L or D, (X2) may be U, H, M or L, (X3) may be H, M, L or D, (Y) may be B, S or X, (V) may be 12 or 24, (Z1) may be 1, 2 or 3, and (Z2) may be 0 or 6.  
Models AB7805HX-EB1, AD5005HX-RC1, AD0618UB F7BDS; Models AB7005(A1)X-ED3, AD5805(A1)X-ED3, AD0812(A2)(B) A7(C1)GL, AS12012(A3)B25A(C2)00, AS12024(A3)B25A(C2)00, AS12048(A3)B25A(C2)00 series, where (A1) may be H or M, (A2) may be X, L or D, (A3) may be U, H, M or L, (B) may be B, S or X, (C1) may be 9 or B, (C2) may be 1, 3, 9 or B.  
Model AD0612(B)X-H9(A) series, where (A) may be 1, 2 or 3, (B) may be U, H, M, L or D.  
Models AD0824XB-F72DS, AB0605HX-HE3, AY07012LX159000, AG08024(X1)(Y)257(Z1)00, AD0412XB-C7(Z2)GP, AD0924(X2)B-A7(Z2)GP, AD0824(X3)B-A7(Z2)GP, AD0812H(Y)-A7(Z1)GL series, where (X1) may be X, U or H, (X2) may be X or U, (X3) may be V, X, U or H, (Y) may be B, S or X, (Z1) may be 0 or 6, (Z2) may be 1, 2 or 3.  
Models AB06305HB10B300, AD0405HB-C5B, AD5005HB-D7B, AQ0912UB-Y7(X)GL series, where (X) may be 1 or 2.

Marking: Company name, model designation and the Recognized Component Mark for Canada,   
Last Updated on 2008-05-29

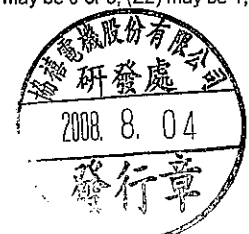



GSA INTERNATIONAL

Certification Record No: 085488 0 000

Class No: 3812 01

AD0612MX-A71GL	12	0.14
AD0612LX-A71GL	12	0.08
AD0624HX-A70GL	24	0.15
AD0624MX-A70GL	24	0.08
AD0624LX-A70GL	24	0.06
AD0624HX-A71GL	24	0.15
AD0624MX-A71GL	24	0.08
AD0624LX-A71GL	24	0.08
AD0812HX-A70GL	12	0.25
AD0812MX-A70GL	12	0.15
AD0812LX-A70GL	12	0.12
AD0812HX-A71GL	12	0.44
AD0812MX-A71GL	12	0.44
AD0812LX-A71GL	12	0.44
AD0812MX-A76GL	12	0.15
AD0824HX-A70GL	24	0.16
AD0824MX-A70GL	24	0.10
AD0824LX-A70GL	24	0.09
AD0824HX-A71GL	24	0.16
AD0824MX-A71GL	24	0.10
AD0824LX-A71GL	24	0.09
AD0424HS-G70, AD0424HB-G70, AD0424HX-G70	24	0.9
AD0405HB-G7B or AD0405HX-G7B or AD0405HS-G7B	5	0.13
AD4505HB-G7B or AD4505HX-G7B or AD4505HS-G7B	5	0.13



DQD No. 548 99/04/08

# Zertifikat

# Certificate



Zertifikat Nr. Certificate No.  
R 50068602

Blatt Page  
0020

Ihr Zeichen Client Reference  
12031916

Unser Zeichen Our Reference  
ZTW2-MRC- 11005418 015

Ausstellungsdatum  
09.05.2006

Date of Issue  
(day/mo/yr)

### Genehmigungsinhaber License Holder

Adda Corporation  
6, East Section, Industry 6 Road  
Pingtung City 900  
Taiwan, R.O.C.

### Fertigungsstätte Manufacturing Plant

Adda Corporation  
6, East Section, Industry 6 Road  
Pingtung City 900  
Taiwan, R.O.C.

### Prüfzeichen Test Mark

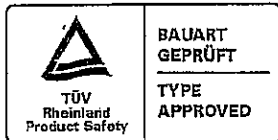

Geprüft nach Tested acc. to  
EN 60950-1:2001+A11

Zertifiziertes Produkt (Geräteidentifikation)  
Certified Product (Product Identification)

Lizenzentgelte - Einheit  
License Fee - Unit

Ventilator (DC Fan)

Wie Blatt (As Page) 01

### Ergänzung (Addition)

Bezeichnung : ADZ1Z2Z3Z4-Z5Z6Z7Z8

(Type Designation)

Z1 steht für (stands for) : 20, 02, 03, 35, 04, 45, 05, 50,  
06, 07, 08, 09, 12 oder (or) 75

Z2 steht für (stands for) : 05, 12, 24 oder (or) 48

Z3 steht für (stands for) : U, H, M, L oder (or) D

Z4 steht für (stands for) : B, S oder (or) X

Z5 steht für (stands for) : A, C, D, F, J, K, Q, R, Y oder  
(or) G

Z6 steht für (stands for) : 5, 7, 9, A, B oder (or) C

Z7 steht für (stands for) : 0, 1, 2, 3, 4, 6, 8, A oder  
(or) B

Z8 steht für (stands for) : freibleibend (blank) oder (or)  
GL

ANLAGE (Appendix) : 1

Dem Zertifikat liegt unsere Prüf- und Zertifizierungsordnung zugrunde.  
Das Produkt entspricht den o.g. Anforderungen, die Herstellung wird überwacht.  
This certificate is based on our Testing and Certification Regulation. The product  
fulfills above-mentioned-requirements, the production is subject to surveillance.

TÜV Rheinland Product Safety GmbH, Am Grauen Stein, D-51105 Köln

Tel.:(+49/221)8 06 - 13 71 Fax:(+49/221)8 06 - 39 35 e-mail: Althoff@de.tuv.com

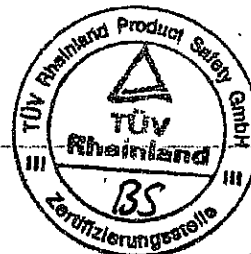

Zertifizierungsstelle



Dipl.-Ing. B. Scheirer