

QLK45/0030-2524

AC tangential blower

forward-curved



ebm-papst Landshut GmbH

Hofmark-Aich-Straße 25

D-84030 Landshut

Phone +49 (0) 871 707-0

Fax +49 (0) 871 707-465

info3@de.ebmpapst.com

www.ebmpapst.com

Nominal data

Type	QLK45/0030-2524	
Phase		1~
Nominal voltage	VAC	230
Frequency	Hz	50
Speed	min ⁻¹	2100
Power consumption	W	32
Current draw	A	0.28
Min. ambient temperature	°C	0
Max. ambient temperature	°C	60
Air flow	m ³ /h	200
Pressure increase	Pa	56

ml = Max. load · me = Max. efficiency · fa = Free air · cs = Customer specification · ce = Customer equipment
Subject to change



Technical description

Weight	1.25 kg
Dimensions	45 mm
Insulation class	"B" on request also F or H
Installation position	Horizontal or vertical with motor on bottom
Cable	Flat plug 6.3 x 0.8

Product drawing

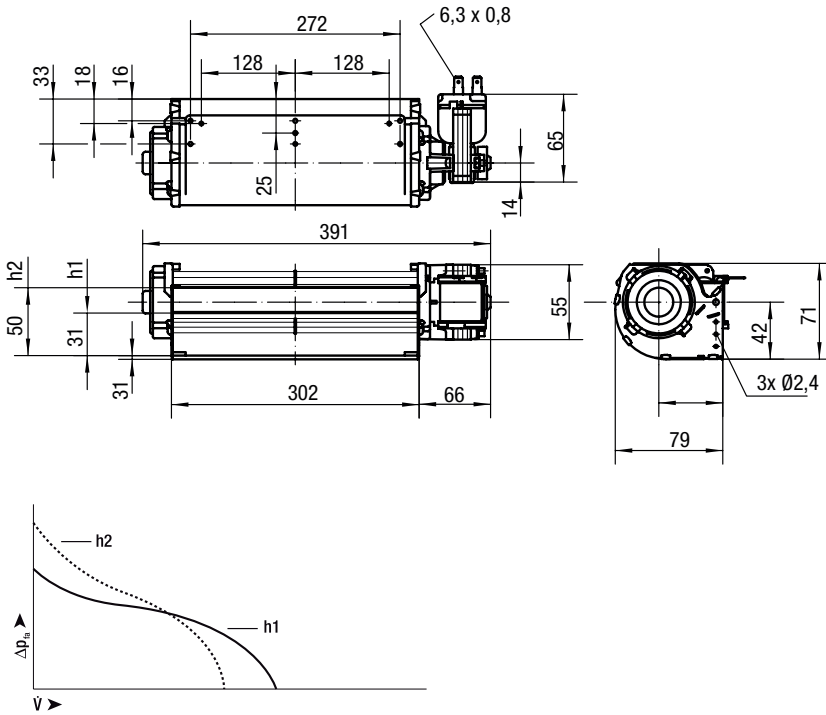

Curves: Air performance

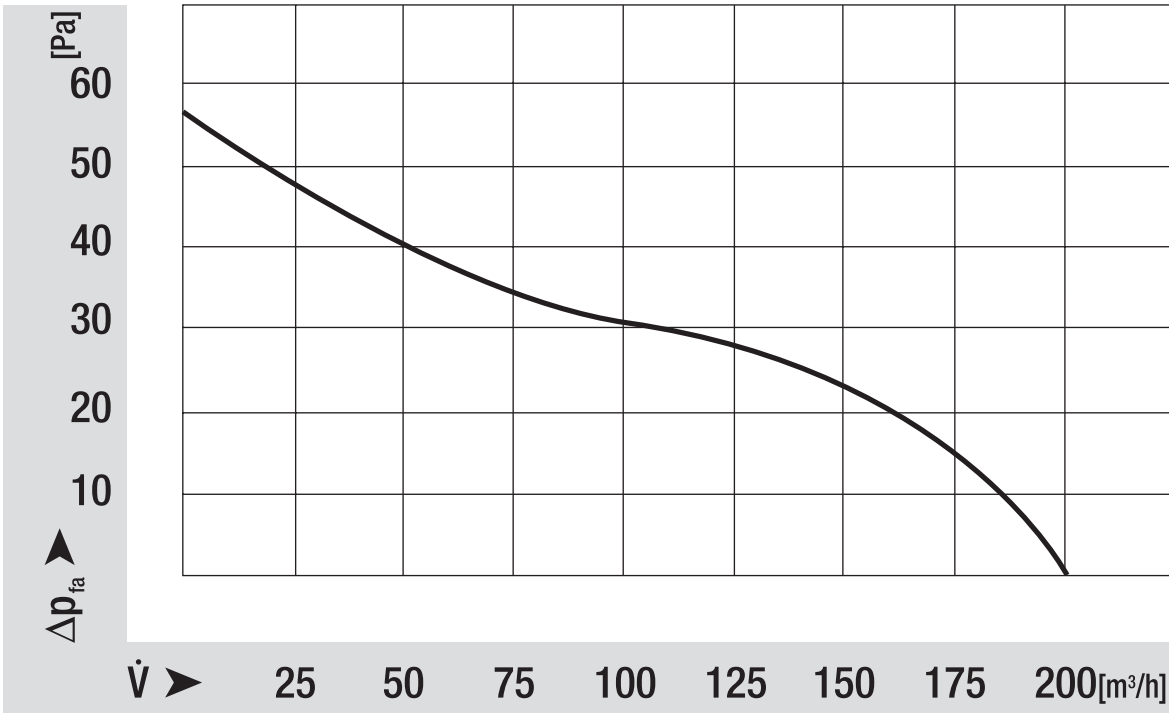

Curves: Speed

