

PLC SERIES CONNECTOR



The 1/4" flow PLC Series is proven worldwide in thousands of applications and offers the widest selection of sizes and configurations. PLC couplings are injection molded from acetal thermoplastic and are resistant to most mild chemical solutions. One-hand connection/disconnection, plus integral terminations make the PLC Series the choice for ease of use and manufacture.

FEATURES

- CPC thumb latch
- Integral terminations
- Clicks when connected
- Compatible

BENEFITS

- One-hand connection and disconnection
- Fewer leak points, shorter assemblies, faster installations
- Assurance of a reliable connection
- Mates with LC and PLC12 Series couplings

Specifications

PRESSURE:

Vacuum to 120 psi, 8.3 bar

TEMPERATURE:

-40°F to 180° F (-40°C to 82°C)

MATERIALS:

- Main components and valves: Acetal
- Thumb latch: Stainless steel
- Valve spring: 316 stainless steel
- External springs and pin: Stainless steel
- O-rings: Buna-N

COLOR: Natural white, others available

TUBING SIZES:

1/4" to 3/8" ID, 6.4mm to 9.5mm ID

JG® TUBING SPECIFICATIONS:

Tube tolerances: 1/4" OD, +0.001/-0.004 | 3/8" OD, +0.001/-0.004

Tube Types: Plastic tube: Polyethylene, nylon, polyurethane. For soft or thin wall tubing with JG® terminations, tube supports are recommended.

Metal tube: Brass, copper and mild steel

Also available in NSF listed versions, please visit our website for part number information.



These graphs are intended to give you a general idea of the performance capabilities of each product line. The shaded area of each graph represents the operating range of the product family, i.e., upper and lower values are shown. Therefore, depending on the exact coupling configurations selected, you can reasonably expect values to fall within the shaded area.

PLC Air Flow, 100 psig Inlet Pressure

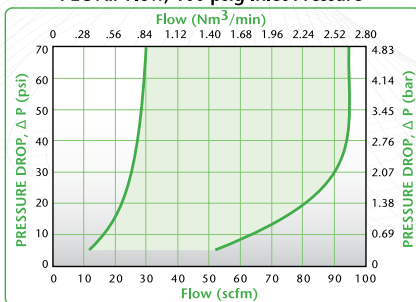

PLC Water Flow

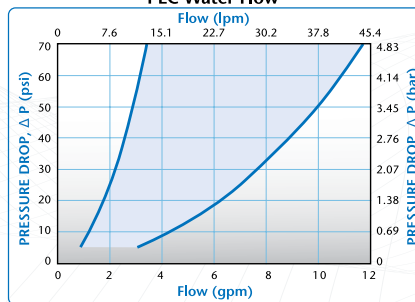

PLC Pressure Range

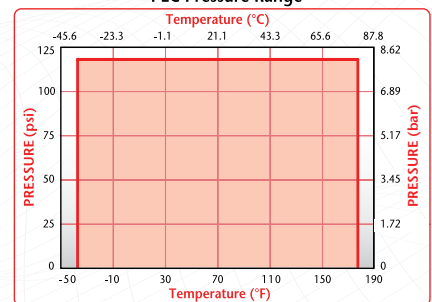

Decoding Coupling Options

Often times, it can be an overwhelming task to decipher which coupling best fits your application needs. The chart below helps to decode popular CPC couplings.

1/4" FLOW OPTIONS	PRIMARY MATERIAL	O-RING	APPLICATION BENEFITS
PLC	Acetal	Buna-N	General purpose plastic connector with metal latch
PLC12	Polypropylene	EPDM	Expanded chemical compatibility
LC	Chrome-Plated Brass	Buna-N	Higher operating temperature and pressure
APC	Acetal	Buna-N	Plastic thumb latch
BREAKAWAY®	Acetal	Buna-N	Breakaway latch
NS4	Glass-filled polypropylene	EPDM	Drybreak, non-spill connect and disconnect, even under pressure

For further information please contact CPC Customer Service at 1-800-444-2474 or 651-645-0091.

Liquid Flow Rate Information for Couplings

The chart below shows the flow rate for CPC couplings. Each coupling was tested with water at 70°F (21°C). To determine flow rates for specific coupling configurations use the formula at the right.

$$Q = C_v \sqrt{\frac{\Delta P}{S}}$$

- Q = Flow rate in gallons per minute
- C_v = Average coefficient across various flow rates (see chart)
- ΔP = Pressure drop across coupling (psi)
- S = Specific gravity of liquid

C_v VALUES FOR 1/4" FLOW PLC COUPLINGS

BODIES	INSERTS	PLC 20004	PLCD 20004	PLC 20006	PLCD 20006	PLC 22004	PLCD 22004	PLC 22006	PLCD 22006	PLC 24004	PLCD 24004	PLC 24006	PLCD 24006	PLC 26004
	PLC10004	.40	.36	1.05	.58	.83	.56	1.40	.82	1.40	.75	1.40	.77	.83
	PLCD10004	.36	.31	.73	.48	.66	.41	.82	.50	.80	.45	.77	.45	.81
	PLC10006	.40	.36	1.05	.60	.83	.56	1.40	.81	1.40	.76	1.40	.76	.83
	PLCD10006	.37	.31	.81	.47	.70	.43	1.02	.51	.98	.46	.99	.48	.98
	PLC12006	.38	.36	.84	.63	.74	.56	1.14	.75	1.14	.70	1.14	.72	.74
	PLCD12006	.38	.33	.78	.49	.68	.44	.84	.49	.81	.43	.82	.44	.81
	PLC16004	.38	.37	.87	.54	.95	.51	1.00	.70	.95	.64	1.00	.66	.95
	PLCD16004	.37	.31	.61	.44	.57	.41	.78	.44	.78	.43	.75	.46	.78
	PLC16006	.38	.37	1.00	.57	.95	.53	1.40	.80	1.40	.71	1.40	.73	1.40
	PLCD16006	.38	.32	.71	.49	.63	.42	.89	.51	.96	.45	.92	.49	.97

PLC DIMENSIONS

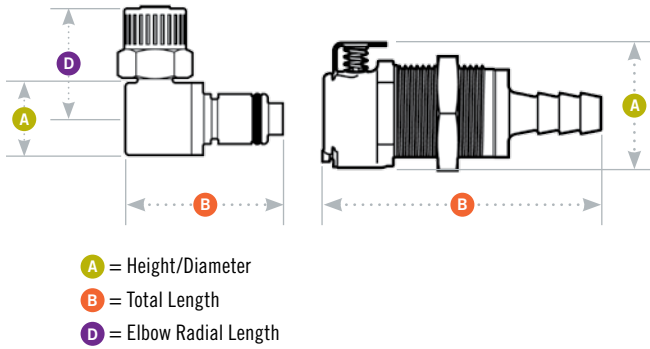

Panel Dimensions

	PANEL OPENING	PANEL THICKNESS MAX.-MIN.	PANEL NUT HEX	PANEL NUT THREAD
COUPLING BODIES	see drawing	.50 - .05	13/16	11/16-24UNEF
COUPLING INSERTS	see drawing	.30 - .05	13/16	11/16-24UNEF

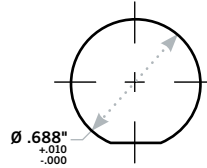

Coupling Bodies • ACETAL

	TUBING/THREAD SIZE	METRIC EQ.	STRAIGHT THRU	SHUTOFF	A	B
TERMINATION IN-LINE PIPE THREAD	1/4" NPT		PLC10004	PLCD10004	.90	1.17
	1/4" BSPT		PLC10004BSPT	PLCD10004BSPT	.90	1.15
	3/8" NPT		PLC10006	PLCD10006	.90	1.15
	3/8" BSPT		PLC10006BSPT	PLCD10006BSPT	.90	1.15
PANEL MOUNT FERRULELESS POLYTUBE FITTING, PTF†	1/4" OD, .17" ID	6.4mm OD, 4.3mm ID	PLC12004	PLCD12004	.88	1.87
		8.0mm OD, 6.0mm ID	PLC120M8	PLCD120M8	.88	1.95
	3/8" OD, .25" ID	9.5mm OD, 6.4mm ID	PLC12006	PLCD12006	.88	1.95
		10.0mm OD, 8.0mm ID	PLC120M10	PLCD120M10	.88	1.95
PANEL MOUNT HOSE BARB	1/4" ID	6.4mm ID	PLC16004	PLCD16004	.88	1.95
	5/16" ID	7.9mm ID	PLC16005	PLCD16005	.88	1.95
	3/8" ID	9.5mm ID	PLC16006	PLCD16006	.88	1.95
PANEL MOUNT JG® PUSH-TO-CONNECT	1/4" OD	6.4mm OD	PLC11004	PLCD11004	.88	1.95
IN-LINE FERRULELESS POLYTUBE FITTING, PTF†	1/4" OD, .17" ID	6.4mm OD, 4.3mm ID	PLC13004	PLCD13004	.94	1.82
		8.0mm OD, 6.0mm ID	PLC130M8	PLCD130M8	.94	1.95
	3/8" OD, .25" ID	9.5mm OD, 6.4mm ID	PLC13006	PLCD13006	.94	1.95
		10.0mm OD, 8.0mm ID	PLC130M10	PLCD130M10	.94	1.95
IN-LINE HOSE BARB	1/4" ID	6.4mm ID	PLC17004	PLCD17004	.94	1.80 / 1.95
	5/16" ID	7.9mm ID	PLC17005	PLCD17005	.94	1.95
	3/8" ID	9.5mm ID	PLC17006	PLCD17006	.94	1.80 / 1.95
IN-LINE JG® PUSH-TO-CONNECT	1/4" OD	6.4mm OD	PLC14004	PLCD14004	.94	1.95
	3/8" OD	9.5mm OD	PLC14006	PLCD14006	.94	2.09

(See page 162 for JG accessories)

All measurements are in inches (millimeters) unless otherwise noted. Tubing must meet stated inside and outside diameters.
 †NOTE: CPC's Ferruleless Polytube Fitting terminations do not require ferrules to achieve a secure connection, which makes them easier to use and reuse. PTF fittings are designed for semi-rigid tubing, i.e., polyethylene, nylon, polyurethane, etc. NOTE: JG is a registered trademark of John Guest USA, Inc.

Coupling Inserts • ACETAL



TERMINATION IN-LINE PIPE THREAD

TUBING/THREAD SIZE METRIC EQ.

STRAIGHT THRU

SHUTOFF

A

B

D

PANEL MOUNT FERRULELESS POLYTUBE FITTING, PTF†

1/4" OD, .17" ID	6.4mm OD, 4.3mm ID	PLC40004	PLCD40004	.72	1.25/1.66
	8.0mm OD, 6.0mm ID	PLC400M8	PLCD400M8	.94	1.91/2.03
3/8" OD, .25" ID	9.5mm OD, 6.4mm ID	PLC40006	PLCD40006	.87	1.25/1.63
	10.0mm OD, 8.0mm ID	PLC400M10	PLCD400M10	.94	1.91/2.05

PANEL MOUNT HOSE BARB

1/4" ID	6.4mm ID	PLC42004	PLCD42004	.94	1.91/2.05
5/16" ID	7.9mm ID	PLC42005	PLCD42005	.94	1.91/2.05
3/8" ID	9.5mm ID	PLC42006	PLCD42006	.94	1.91/2.05

PANEL MOUNT JG® PUSH-TO-CONNECT

1/4" OD	6.4mm OD	PLC41004	PLCD41004	.94	1.91/2.05
---------	----------	----------	-----------	-----	-----------

IN-LINE FERRULELESS POLYTUBE FITTING, PTF†

1/4" OD, .17" ID	6.4mm OD, 4.3mm ID	PLC20004	PLCD20004	.72	1.25/1.88
	8.0mm OD, 6.0mm ID	PLC200M8	PLCD200M8	.72	1.38/1.82
3/8" OD, .25" ID	9.5mm OD, 6.4mm ID	PLC20006	PLCD20006	.72	1.38/1.82
	10.0mm OD, 8.0mm ID	PLC200M10	PLCD200M10	.72	1.38/1.82

IN-LINE HOSE BARB

1/4" ID	6.4mm ID	PLC22004	PLCD22004	.62	1.35/1.99
5/16" ID	7.9mm ID	PLC22005	PLCD22005	.62	1.35/1.99
3/8" ID	9.5mm ID	PLC22006	PLCD22006	.62	1.36/1.81

IN-LINE JG® PUSH-TO-CONNECT

1/4" OD	6.4mm OD	PLC29004	PLCD29004	.63	1.35/1.95
3/8" OD	9.5mm OD	PLC29006	PLCD29006	.78	1.51/2.11

ELBOW FERRULELESS POLYTUBE FITTING, PTF†

3/8" OD, .25" ID	9.5mm OD, 6.4mm ID	PLC21006	PLCD21006	.61/.62	1.22/1.35	.85/.96
------------------	--------------------	----------	-----------	---------	-----------	---------

ELBOW HOSE BARB

1/4" ID	6.4mm ID	PLC23004	PLCD23004	.67/.63	1.10/1.28	.85/.96
3/8" ID	9.5mm ID	PLC23006	PLCD23006	.67/.63	1.25/1.28	.90/.96

All measurements are in inches (millimeters) unless otherwise noted. Tubing must meet stated inside and outside diameters. Couplings are pictured with valves unless otherwise noted.

†NOTE: CPC's Ferruleless Polytube Fitting terminations do not require ferrules to achieve a secure connection, which makes them easier to use and reuse. PTF fittings are designed for semi-rigid tubing, i.e., polyethylene, nylon, polyurethane, etc. NOTE: JG is a registered trademark of John Guest USA, Inc.