

# PTS645 Series 6 mm Tact Switches

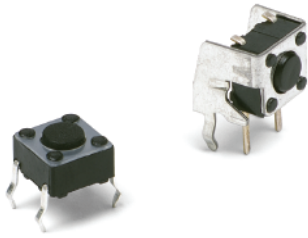

## Features/Benefits

- Compact size 6 x 6 mm
- Variety of actuator lengths
- Choice of actuation force
- RoHS compliant and compatible

## Typical Applications

- Consumer products
- Instrumentation
- Computer products
- Industrial

B

Tactile Switches

### Specification

FUNCTION: Momentary action  
CONTACT ARRANGEMENT: SPST, N.O.  
TERMINALS: PC pins

### Mechanical

ACTUATION FORCE: 130 grams, 160 grams, 200 grams, 260 grams  
LIFE EXPECTANCY: 100,000 operations.

### Electrical

CONTACT RATING: 50 mA @ 12 V DC.  
DIELECTRIC STRENGTH: 250 V AC min.  
CONTACT RESISTANCE: 100 mΩ max. initial.  
INSULATION RESISTANCE: 10<sup>11</sup> Ω min.

### Environmental

OPERATING TEMPERATURE: -20°C to 60°C

### Process

SOLDERING: Preheating to 100°C for 45 sec. max. Keep flux flush with top surface of PCB; do not apply to component side of PCB and area where terminals are located. Soldering to 255°C for 5 sec. max. Clean by brushing on solder surface. Do not clean switch with solvents.

### Packaging

Bulk packaging.

#### Tape & reel for the SMT type:

Reels of 1,000 pieces for 4,3 and 5,0 mm height  
Reels of 700 pieces for 7,0 mm height  
Reels of 500 pieces for 9,5 mm height  
Reels of 400 pieces for 13,0 mm height

**NOTE:** Specifications listed above are for switches with standard options.  
For information on specific and custom switches, consult Customer Service Center.

## How To Order

Our easy build-a-switch concept allows you to mix and match options to create the switch you need. To order, select desired option from each category and place it in the appropriate box.

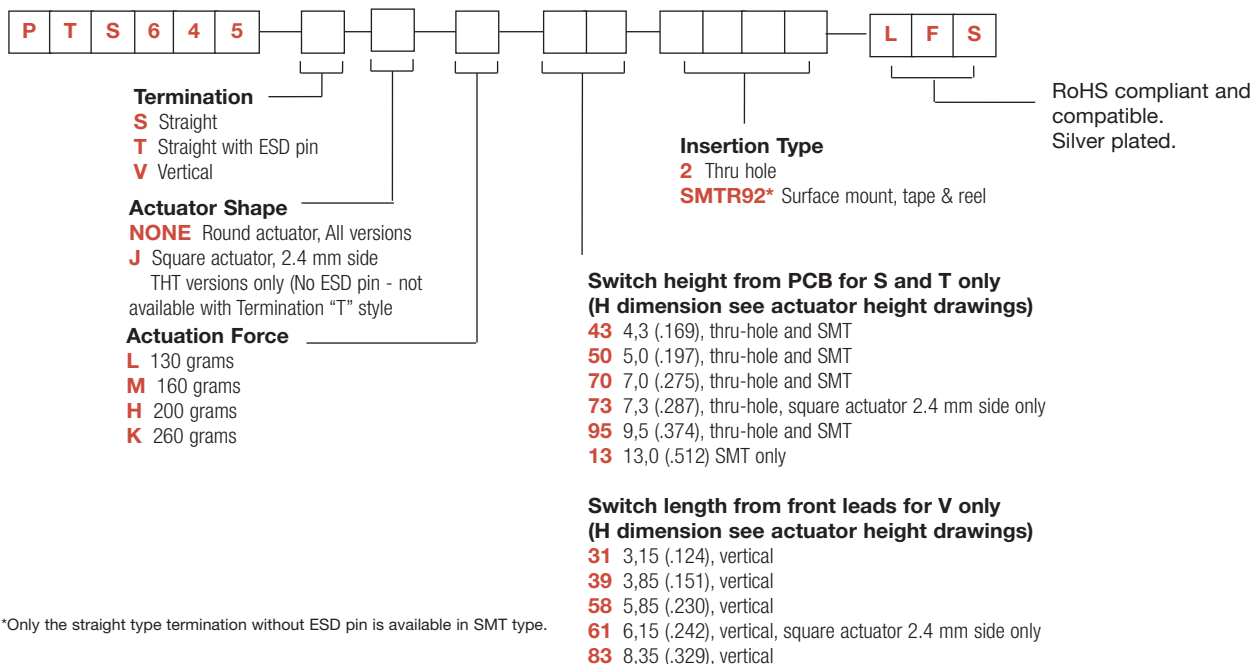

\*Only the straight type termination without ESD pin is available in SMT type.



Dimensions are shown: mm  
Specifications and dimensions subject to change

# PTS645 Series 6 mm Tact Switches

## TERMINATION

### S STRAIGHT

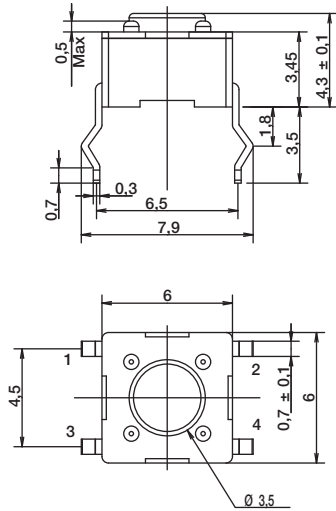

SCHEMATIC

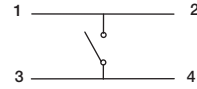

PCB LAYOUT

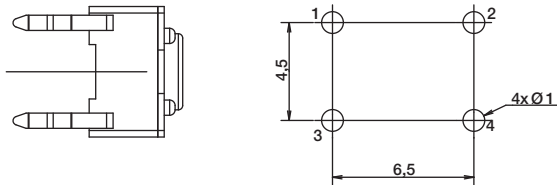

### T STRAIGHT WITH ESD PIN

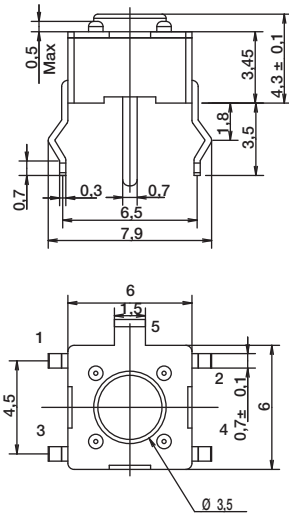

SCHEMATIC

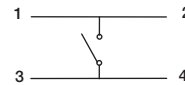

PCB LAYOUT

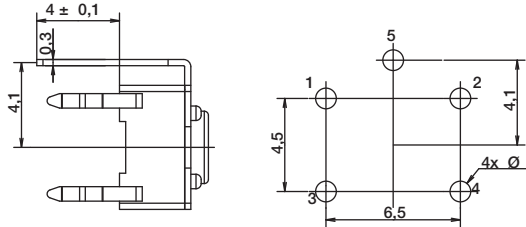

### V VERTICAL

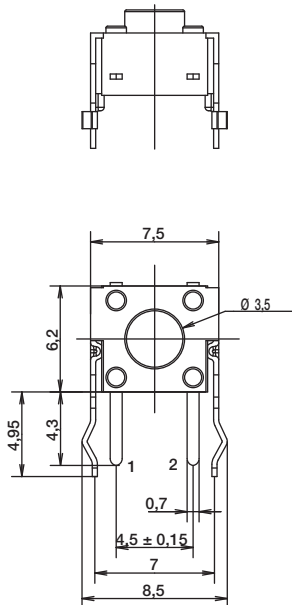

SCHEMATIC

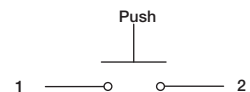

PCB LAYOUT

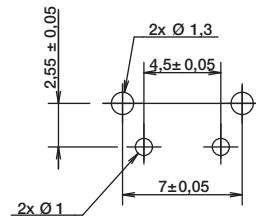

Dimensions are shown: mm  
Specifications and dimensions subject to change

# PTS645 Series 6 mm Tact Switches

## TERMINATION

### SMT

FOR 4.3, 5.0, 7.0, 9.5 MM HEIGHT

13.0 MM HEIGHT ONLY

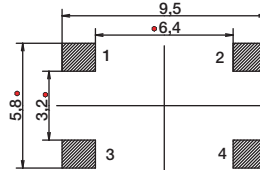
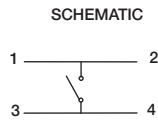
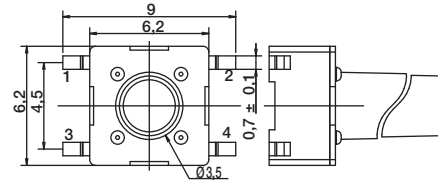
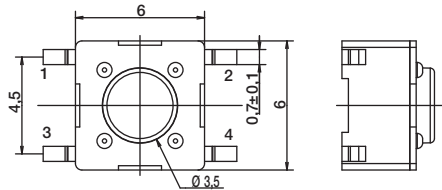
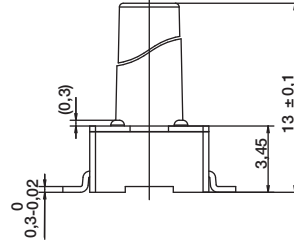
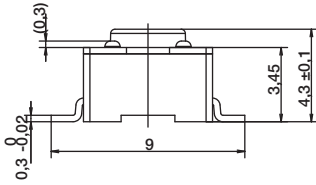

PCB LAYOUT

## ACTUATOR SHAPE

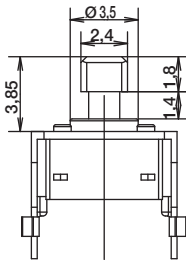

SCHEMATIC

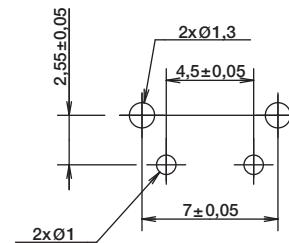
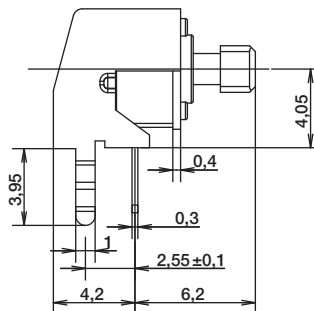
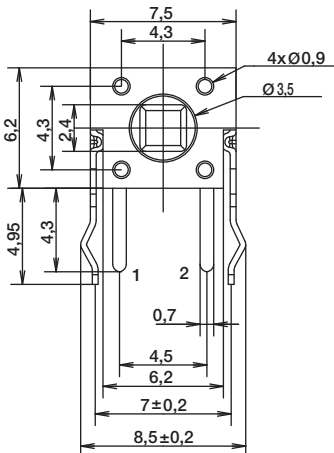
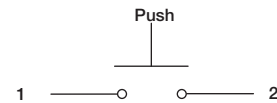

RECOMMENDED PCB LAYOUT

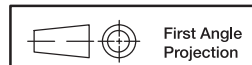

Dimensions are shown: mm  
Specifications and dimensions subject to change

# PTS645 Series 6 mm Tact Switches

## ACTUATOR SHAPE

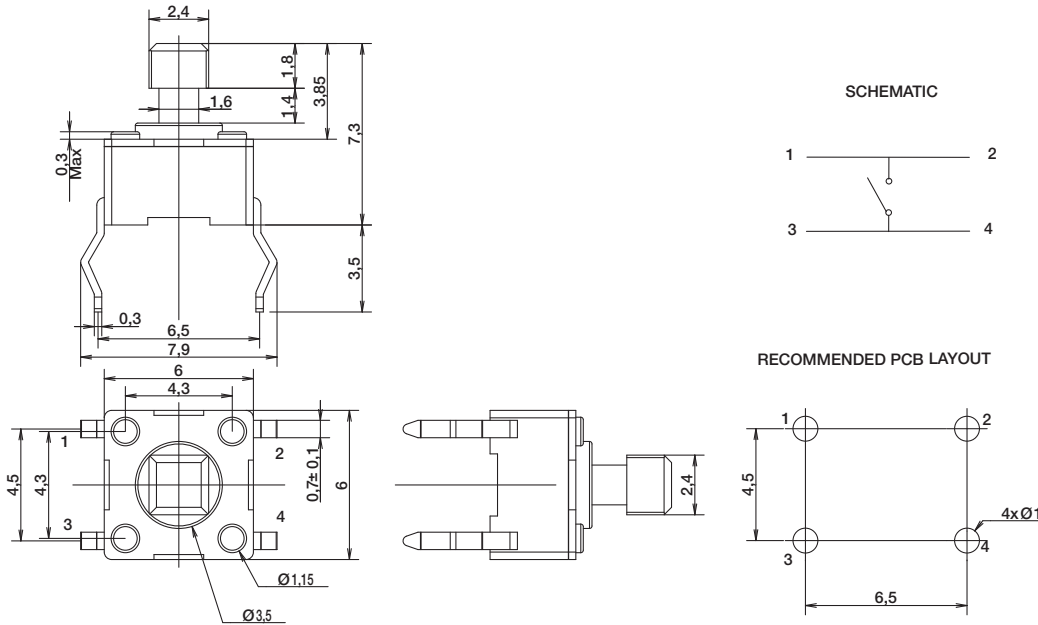

B

Tactile Switches

## ACTUATION FORCE

| OPTION CODE | FORCE           |
|-------------|-----------------|
| <b>L</b>    | 130 grams Black |
| <b>M</b>    | 160 grams Blue  |
| <b>H</b>    | 200 grams Gray  |
| <b>K</b>    | 260 grams Red   |

## ACTUATOR HEIGHT

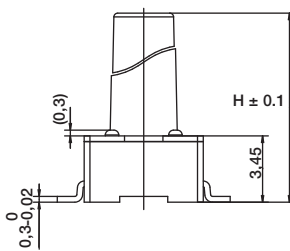

### Switch height from PCB for S and T only

| OPTION CODE | DIMENSION H | TERMINATION       | SCHEMATIC       |              |
|-------------|-------------|-------------------|-----------------|--------------|
|             |             |                   | Without EMC pin | With EMC pin |
| <b>43</b>   | 4,3 (.169)  | Thru-hole and SMT | 1 — 2           | 1 — 2        |
| <b>50</b>   | 5,0 (.197)  | Thru-hole and SMT | 1 — 2           | 1 — 2        |
| <b>70</b>   | 7,0 (.275)  | Thru-hole and SMT | 3 — 4           | 3 — 4        |
| <b>95</b>   | 9,5 (.374)  | Thru-hole and SMT | 3 — 4           | 3 — 4        |
| <b>13</b>   | 13,0 (.512) | SMT               |                 |              |

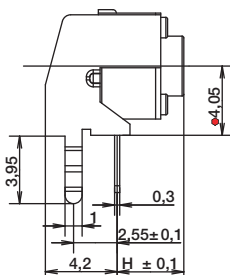

### Switch length from front leads for V only

| OPTION CODE | DIMENSION H | TERMINATION | SCHEMATIC       |              |
|-------------|-------------|-------------|-----------------|--------------|
|             |             |             | Without EMC pin | With EMC pin |
| <b>31</b>   | 3,15 (.124) | Vertical    |                 | 1 — 3        |
| <b>39</b>   | 3,85 (.151) | Vertical    |                 | 1 — 3        |
| <b>58</b>   | 5,85 (.230) | Vertical    |                 | 1 — 3        |
| <b>83</b>   | 8,35 (.329) | Vertical    |                 | 1 — 3        |

# PTS645 Series 6 mm Tact Switches

## TAPE & REEL

B

Tactile Switches

