

CB-OWS451 AND CB-OWL253 ELECTRICAL AND MECHANICAL DATASHEET

This is a draft version of the document

Document Revision

Release: 28 sep, 2010 11:35

Document version: 27

constitute any binding undertakings from connectBlue AB. connectBlue AB is not responsible under any circumstances for direct, indirect, unexpected damage or consequent damage that is caused by this document. All rights reserved. All brand and product names are trademarks or service marks of their respective owners.

1 Table of Content

- 1 Table of Content
- 2 Introduction
 - 2.1 Key features
 - 2.2 Product variants
 - 2.3 Block diagram
- 3 Electrical interface and connectors
 - 3.1 Pin numbering
 - 3.2 Pin description
 - 3.3 Characteristics
 - 3.4 Hardware Reset
 - 3.5 Power Control
- 4 Antenna Information
 - 4.1 Surface mounted antenna (internal)
 - 4.2 External antennas
 - 4.3 Antenna accessories
 - 4.4 Antennas
- 5 Mounting information
 - 5.1 Module dimensions
 - 5.2 Using the J2/J3 board-to-board connectors
 - 5.3 Using press-fit nuts for mounting
 - 5.4 Recommended M2 screw
 - 5.5 Antenna issues
- 6 WLAN information
 - 6.1 Radio sensitivity OFDM
 - 6.2 Radio sensitivity DSSS
- 7 Regulatory information
 - 7.1 Limitations
 - 7.2 Declaration of conformity
 - 7.3 IC and FCC compliance
 - 7.4 UL listing information
 - 7.5 Compliance with RoHS directive
- 8 Guidelines for efficient and safe use
 - 8.1 General
 - 8.2 Product care
 - 8.3 Radio frequency exposure
 - 8.4 Electronic equipment
 - 8.5 Potentially explosive atmospheres
 - 8.6 Safety compliance
- 9 Design examples
 - 9.1 Basic design

2 Introduction

The IEEE 802.11abgn OEM Modules from connectBlue has been developed for integration in industrial devices. The modules are providing state of the art low power features, compatibility, robustness, and reliability. The modules minimizes the work needed to implement IEEE 802.11 in a device as it provides, together with the driver package, all software, hardware, type approval, EMC certification etc. It is developed for reliable, high demanding industrial devices and applications and delivers high performance. The connectBlue wireless LAN modules are available in different versions (see Product variants).

The wireless LAN modules are complete IEEE 802.11 implementations. The IEEE 802.11 modules has small form factors and the interface layout is the same as the Bluetooth and IEEE 802.15.4 modules from connectBlue, which enables customers to prepare their device for both wireless LAN, IEEE 802.15.4, and Bluetooth.

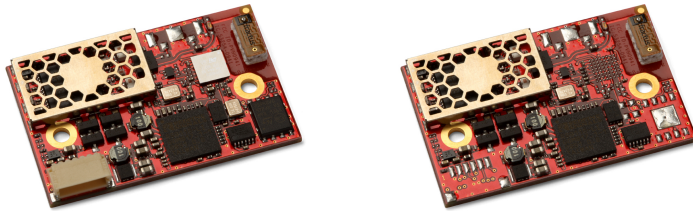

2.1 Key features

- Dual-band operation (IEEE 802.11-2007, abg, incl. single stream IEEE 802.11n)
- WEP, AES, and CRC-32 hardware accelerators
- WPA and WPA2 support - both personal and enterprise modes
- UART host interface
- SPI host interface
- Quality of Service: 802.11e and WMM
- Ad-hoc and infrastructure mode
- Bluetooth co-location with PTA (Packet Traffic Arbitration) support
- Radio type approved for Europe.
- Unlicensed Modular Transmitter Approval for US (FCC) and Canada (IC).
- Compliant with EMC standards.
- Industrial temperature range -40 to +85 °C.
- Support for low power modes.
- Compatible with connectBlue Bluetooth and IEEE 802.15.4 modules
- Internal or external antenna
- Receive diversity

2.2 Product variants

This electrical & mechanical data sheet is applicable the following wireless LAN modules from connectBlue:

- cB-OWL253
- cB-OWS451

The hardware of the cB-OWS451 and cB-OWL253 products are referred to as cB-0942. The module is Type Approved and referred in this document with the type name cB-0942.

Product name	Regulatory ID	FCC ID	IC ID	Description
cB-OWL253i-04	cB-0942	PVH0942	5325A-0942	IEEE802.11abgn LAN module with internal antenna, board-to-board connector, solder-lands, high-speed SPI host interface
cB-OWL253x-04	cB-0942	PVH0942	5325A-0942	IEEE802.11abgn LAN module with dual external antenna U.FL. connectors, board-to-board connector, solder-lands, high-speed SPI host interface
cB-OWS451i-04	cB-0942	PVH0942	5325A-0942	IEEE802.11abgn Serial Port Adapter module with internal antenna, board-to-board connector, solder-lands, UART host interface
cB-OWS451x-04	cB-0942	PVH0942	5325A-0942	IEEE802.11abgn Serial Port Adapter module with dual external antenna U.FL. connectors, board-to-board connector, solder-lands, UART host interface

cB-OWS451i-06	cB-0942	PVH0942	5325A-0942	IEEE802.11abgn Serial Port Adapter module with internal antenna, board-to-board connector, solder-lands, JST connector, UART host interface
cB-OWS451x-06	cB-0942	PVH0942	5325A-0942	IEEE802.11abgn Serial Port Adapter module with dual external antenna U.FL. connectors, board-to-board connector, solder-lands, JST connector, UART host interface

2.3 Block diagram

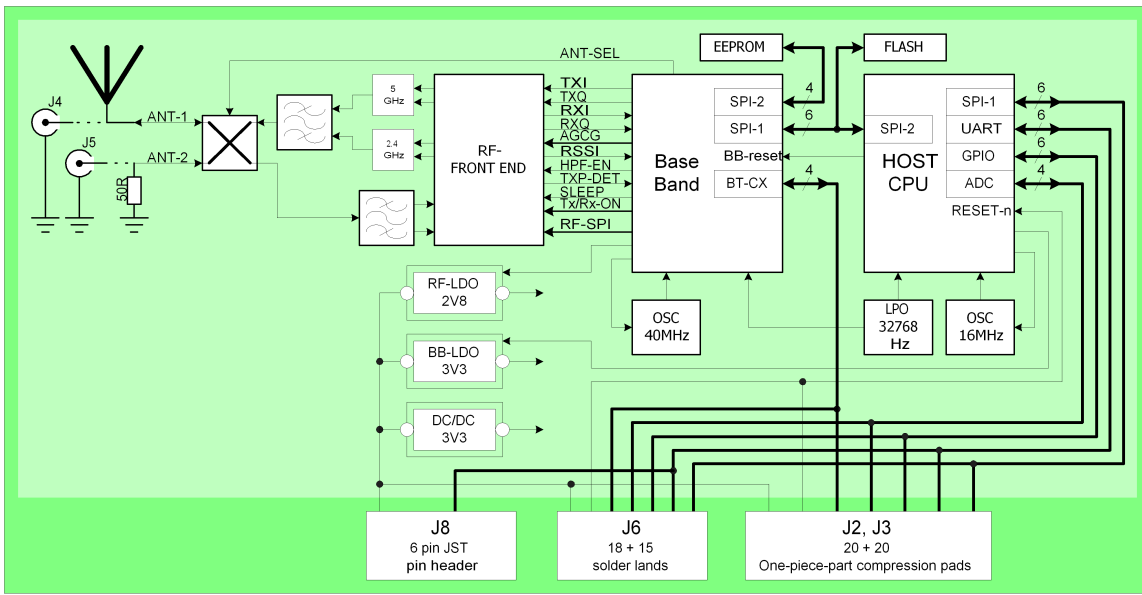

3 Electrical interface and connectors

This section describes the signals available on the module interface connectors. There are three ways of connecting:

- Via the PCB solder lands on the edge of the PCB, J6 (see figure below: Secondary side connectors). For more information see Section J6 Solder Lands Description.
- Via the 2 x 20-pin 1mm pitch board-to-board (one piece part) connectors J2 and J3. The J2 and J3 connectors exist on the module only as compression pads (see figure below: Secondary side connectors). These pads mates with the carrier board one-piece part connector. For more information see Section J2 Connector Description and J3 Connector Description.

Optional:

- Via the JST connector, J8 (see figure below: Primary side connectors). The connector is a 6 poles pin header. The pitch is 1mm and the connector is from JST with part number SM06B-SRSS-TB. For more information see section J8 Connector Description.

3.1 Pin numbering

3.1.1 Primary side connectors

J8 is the JST connector located on the primary side of the module. A1 is the internal antenna.

J4 and J5 are U.FL connectors for external antennas. J4 is the primary antenna connector and J5 the auxiliary antenna connector.

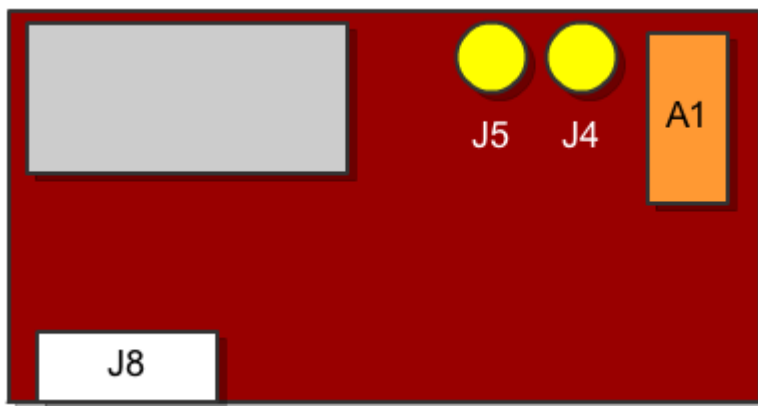

3.1.2 Secondary side connectors

J2 and J3 is the connectBlue board-to-board connector. The pin layout of the connector is compatible with all OEM Serial Port Adapters from connectBlue.

The J6 is the solder land connector.

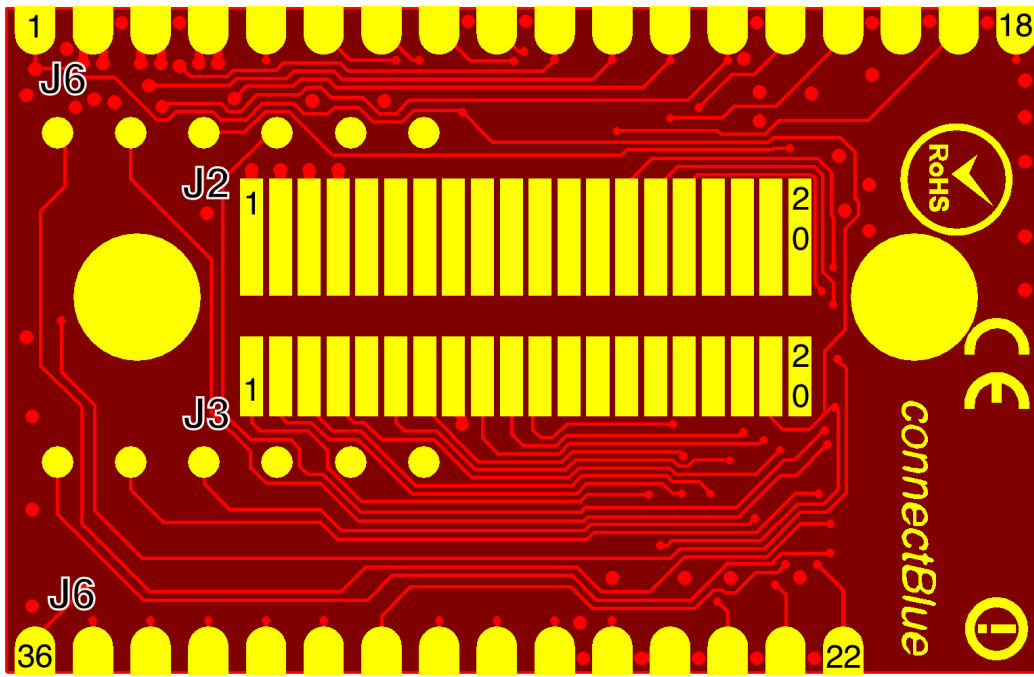

 Solder lands connector (J6) has a new layout compared to cB-OWSPA311g.

3.2 Pin description

3.2.1 J2, J3, J6, J8 connector description

J2 Pin Nr	J3 Pin Nr	J6 Pin Nr	J8 Pin Nr	Signal Name	Signal Level	Type	Description
1,2	8	3, 25***	1	VSS	Ground	Power	GND
3,4	-	4	2	VCC	3.3 V	Power	3.3 - 5.5 VDC power supply
11	-	7		RED/Mode	CMOS	Out/In	<p>This signal is multiplexed:</p> <p>RED: red LED logic signal valid 600ms after power-up (see the Operating status section), active low.</p> <p>Mode: Mode signal is valid as input only during the first 600ms after startup, after that its function changes to red LED. The Mode pin is active low with internal weak pull-up</p>
12	-	6		Switch-0	CMOS	In	<p>Used for the "Connect on external signal" function, see the Serial Port Adapter AT command Specification for more information on the Function switch, active low. The Switch-0 pin has internal weak pull-up</p> <p>A secondary function is that the module will restore all factory settings if both the Switch-1 and Switch-0 signals are low during start up. See the Serial Port Adapter AT command Specification for more information on the Restoring Default Configuration functionality.</p> <p>See section Switch-0 Signal for design examples.</p>
13	-	8		GREEN/Switch-1	CMOS	Out/In	<p>This signal is multiplexed:</p> <p>GREEN: green-LED logic signal valid 500ms after power-up (see the Operating status section), active low.</p> <p>Switch-1: Switch-1 signal is valid as input only during the first 500ms after power-up, after that its function changes to green-LED. If this pin is pulled-down** the unit goes back to default serial settings. The Switch-1 signal is active low with internal weak pull-up</p> <p>The module will restore all factory settings if both the Switch-1 and Switch-0 signals are pulled-down during power-up. See the Serial Port Adapter AT command Specification for more information on the Restoring Default Configuration functionality.</p> <p>See section GREEN/Switch-1 for design examples</p>
14	-	9	5	BLUE	CMOS	Out	<p>Logic Blue LED Signal (see the Operating status, table 9 section). Active low.</p> <p>Note: Blue LED will flash when data is transferred.</p> <p>See section BLUE Signal for design examples.</p>
15	-	10	5	UART-CTS*	CMOS	In	Logic level UART Clear To Send, active low.
16	-	11	3	UART-TxD*	CMOS	Out	Logic level UART Transmit Data, "0" = Low, "1" = High
17	-	12	6	UART-RTS*	CMOS	Out	Logic level UART Request To Send, active low.
18	-	13	4	UART-RxD*	CMOS	In	Logic level UART Receive Data, "0" = Low, "1" = High
19	-	5	-	UART-DTR*	CMOS	Out	Logic level UART Data Terminal Ready, active low.
20	-	18, 30***	-	UART-DSR*	CMOS	In	Logic level UART Data Set Ready, active low.
	6	28	-	SPI-CS0n	CMOS	In	Logic level SPI chip select, active low.
	7	27	-	SPI-MOSI	CMOS	In	Logic level SPI Master Output Slave Input
	9	36	-	SerialSelect-0	CMOS	Out	Control signal for external serial transceivers. See Appendix Serial Interface section for more info.

	10	35	-	SerialSelect-1	CMOS	Out	Control signal for external serial transceivers. See Appendix Serial Interface section for more info.
	11	26	-	SPI-CLK	CMOS	In	Logic level SPI Clk input
-	13	24	-	SPI-MISO	CMOS	Out	Logic level SPI Master Input Slave Output
-	14	23	-	SPI-Int	CMOS	In	Logic level SPI external interrupt.
-	19	1	-	Reset-n	CMOS	In	Hardware reset. Active low. internal 100k ohm pull-up
-	20	2	-	VCC-3V	3.0 V	Out	Regulated interface voltage for voltage level shifting, max 10mA.
5 - 10	1 - 5, 12, 15 - 18	14 - 17, 19 - 21, 29, 31 - 34	-				Reserved, do not connect.

*** Alternative signal pin recommended to use in new designs (both signal pins should be connected).

- Logic level signals are CMOS logic level ($-0.3V < V_{IL} < 0.8V$, $2.3V < V_{IH} < 3.3V$).

3.2.2 J4 Primary external antenna connector

J4 is the primary external antenna connector. It is used for both transmit and receive. The port impedance to match is 50Ω.

J4 pin nr	Pin name	Signal level	Type	Description
1	Ant-1	RF	I/O	Primary external antenna port (50Ω)

 This connector is only available on the cB-OWS451x and cB-OWL253x.

3.2.3 J5 Auxiliary external antenna connector

J5 is the auxiliary external antenna connector. It is used only for receiving and if the unit is configured for receive diversity mode. The unit never transmits RF through this antenna connector. The port impedance to match is 50Ω.

J5 pin nr	Pin name	Signal level	Type	Description
1	Ant-1	RF	I	Auxiliary external antenna port (50Ω)

 This connector is only available on the cB-OWS451x and cB-OWL253x.

1. UART signals are CMOS logic level ($-0.3V < V_{IL} < 0.9V$, $2.1V < V_{IH} < 3.3V$)

3.3 Characteristics

The OWSPA311g module is designed to be fully interchangeable with the connectBlue Bluetooth product range. If the host product has space for the board, it is possible to choose freely between Bluetooth modules, e.g. cB-OEMSPA311i/x or cB-OEMSPA331i/x, or WLAN modules, e.g. OWSPA311gi/x, without any change of the host product. If you design your power supply for cB-OWS451i/x the modules will be fully interchangeable.

3.3.1 Power supply

 Read the safety notes in section Guidelines for Efficient and Safe Use before using the modules.

3.3.1.1 Supply voltage

Symbol	Parameter	Min	Typ.	Max	Unit
VDD	Supply voltage	3.3		5.5	V

3.3.1.2 Current consumption

Symbol	Mode	Min	Typ.	Max	Unit
--------	------	-----	------	-----	------

3.3.2 Input/output signals

Symbol	Parameter	Min	Typ	Max	Unit
VIN Low	Logic LOW level input voltage on all logic	-0.3		0.85	V
VIN High	Logic HIGH level input voltage	2.1		3.3	V
VOU Low	Logic LOW level output voltage			0.4	V
VOU High	Logic HIGH level output voltage	2.5			V
I GPIO	Sink and source current			4.0	mA
C GPIO	Input capacitance		8		pF

3.4 Hardware Reset

A hardware-reset input is available on the J1 and J3 connectors. An external reset source must be open drain or collector. The RESET-n pin is pulled-up internally with 15 kOhm.

3.5 Power Control

The wireless LAN modules can be operated in several different power modes.

- Standard IEEE802.11 power save
- UAPSD/WMM Power Save Support

4 Antenna Information

This chapter gives a quality overview of the different antenna options.

There are 2 different antenna options available:

- An internal surface mounted (SMD) antenna.
- Two U.FL connectors for external antennas. Different types of external antennas are available.

4.1 Surface mounted antenna (internal)

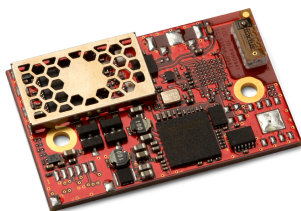

Part number	cB-OWL253 / cB-OWS451
Antenna	FR05-S1-NO-1-004
Manufacturer	Fractus
Gain	0 dBi @ 2.4GHz, 3 dBi @ 5GHz
avg. VSWR	3.1 @ 2.4GHz, 2.3 @ 5GHz
avg. Efficiency	22% @ 2.4GHz, 39% @ 5GHz
Antenna size (LxWxH)	7 x 3 x 2 mm

Comments	The antenna gain is very dependent of the mounting of the module. The unit cannot be mounted in a metal-shielded enclosure with this antenna.
----------	--

4.1.1 Radiation patterns

Unable to render embedded object: File (Topview of OWL253_lowres.png) not found.

4.1.1.1 Radiation Pattern Cuts @2450 MHz – Free Space

Unable to render embedded object: File (RadiationPattern24.png) not found.

4.1.1.2 Radiation Pattern Cuts @5400 MHz – Free Space

Unable to render embedded object: File (RadiationPattern5.png) not found.

4.2 External antennas

The external antennas are connected to the board through a U.FL connector. Some of the antennas are connected directly to the U.FL connector of the board and some are connected using an SMA or reversed polarity SMA connector through a short U.FL to SMA or reversed polarity SMA adapter cable.

Other antennas are also available on request. Please contact connectBlue for more information.



Antennas with SMA connectors are not allowed to be used in USA or Canada due to FCC / IC regulations. For USA and Canada antennas with **reversed polarity SMA** connectors are allowed.

4.3 Antenna accessories



Part Number	cB-ACC-18 / cB-ACC-48
Name	U.FL to SMA adapter cable
Connector	U.FL and SMA jack (outer thread and pin receptacle)
Cable length	120 mm
Cable loss	Less than 0.5 dBm
Comments	The SMA connector may be mounted in a panel. Not approved for use in the US and Canada. Approved for EU.

Part Number	cB-ACC-38
Name	U.FL to reverse polarity SMA adapter cable
Connector	U.FL and reverse polarity SMA jack (outer thread and pin)
Cable length	120 mm
Cable loss	Less than 0.5 dBm
Comments	The reverse polarity SMA connector may be mounted in a panel. Approved for use in the US, Canada and Europe.

4.4 Antennas

4.4.1 Dual-band antennas



Part Number	cB-ACC-53 / cB-ACC-54
Name	Ex-IT WLAN RPSMA / Ex-IT WLAN SMA
Manufacture	ProAnt
Type	½ wave dipole
Polarization	Vertical
Gain	+3 dBi
Size	107 mm (Straight)
Connector	cB-ACC-53: Reverse Polarity SMA plug (inner thread and pin receptacle) cB-ACC-54: SMA plug (inner thread and pin)
Comment	To be mounted on the U.FL to SMA or reverse polarity SMA adapter cable.
Approval	Both SMA and Reverse Polarity SMA versions are approved for use in Europe. The SMA version is not approved for use in the US and Canada. The Reverse Polarity SMA version is approved for use in the US, Canada and Europe.

4.4.2 Single-band antennas



Part Number	cB-ACC-16 / cB-ACC-36
Name	WCR2400-SMA / WCR2400-SMRP
Manufacture	Laird Technologies / Centurion

Type	½ wave dipole
Polarization	Vertical
Gain	+2.5 dBi
Size	100 mm (Straight)
Connector	cB-ACC-16: SMA plug (inner thread and pin) cB-ACC-36: Reverse Polarity SMA plug (inner thread and pin receptacle)
Comment	To be mounted on the U.FL to SMA or reverse polarity SMA adapter cable.
Approval	Both SMA and Reverse Polarity SMA versions are approved for use in Europe. The SMA version is not approved for use in the US and Canada. The Reverse Polarity SMA version is approved for use in the US, Canada and Europe.



Part Number	cB-ACC-27
Name	WCR-2400-IP04
Manufacture	Laird Technologies / Centurion
Type	½ wave dipole
Polarization	Vertical
Gain	+2.0 dBi
Size	108 mm (Straight)
Cable length	100 mm (250 mm is also available)
Connector	U.FL. connector
Comment	To be mounted on the U.FL connector on the PCB.
Approval	Approved for use in the US, Canada and Europe.



Part Number	cB-ACC-23
Name	Mobile Mark Stub
Manufacture	Mobile Mark Communications Antennas
Type	¼ wave dipole

Polarization	Vertical
Gain	0 dBi
Size	Ø 9.5 x 26 mm
Connector	SMA plug (inner thread and pin)
Comment	To be mounted on the U.FL to SMA adapter cable.
Approval	Approved for Europe. Not approved for use in the US and Canada.



Part Number	cB-ACC-17
Name	Reel planTec Bluetooth m70
Manufacture	REEL
Type	Patch antenna
Gain	+1.0 dBi
Size	Ø 75 x 20 mm
Mounting	M16 x 13.6 mm
Connector	SMA plug (inner thread and pin)
Cable length	300 cm. Other cable lengths are available on request.
Comment	To be mounted on the U.FL to SMA adapter cable.
Approval	Approved for Europe. Not approved for use in the US and Canada. Please contact connectBlue for information about US and Canada approved versions of the antenna with Reverse Polarity SMA plug connector.



Part Number	cB-ACC-21
Name	Rugged SMA R380.500.127
Manufacture	Radiall/Larsen
Type	½ wave dipole
Polarization	Vertical
Gain	+2.0 dBi
Size	Ø 14.3 x 61.4 mm
Connector	SMA plug (inner thread and pin)
Comment	To be mounted on the U.FL to SMA adapter cable.
Approval	Approved for Europe. Not approved for use in the US and Canada. Please contact connectBlue for information about US and Canada approved versions of the antenna with Reverse Polarity SMA plug connector.

5 Mounting information

5.1 Module dimensions

Unable to render embedded object: File (w23_measure_A.PNG) not found.

Antenna keep out area 10.2mm x 6.9mm. No copper inside this area.
Tolerances:

1. Outline dimensions +/- 0.1mm
2. Drilled hole to outline: +/- 0.05mm

Unable to render embedded object: File (w23_measure_B.PNG) not found.

Unable to render embedded object: File (w23_measure_C.PNG) not found.

5.1.1 Mounting holes

There are 2 x 2.3mm mounting holes on cB-0942. The reasons for the 2.3mm holes are that the threaded M2 holes on the single and double row connectors (see section 4.2.1) are not aligned. The outer tangents of the 2.3mm holes align the module if the single row connectors are used and the inner if double row connectors are used (see Figure 11). Choose the outer tangent (CC distance 27.24mm) if the module is aligned and mounted with some other technique based on M2 screws (e.g. press-fit nuts), see Figure 12.

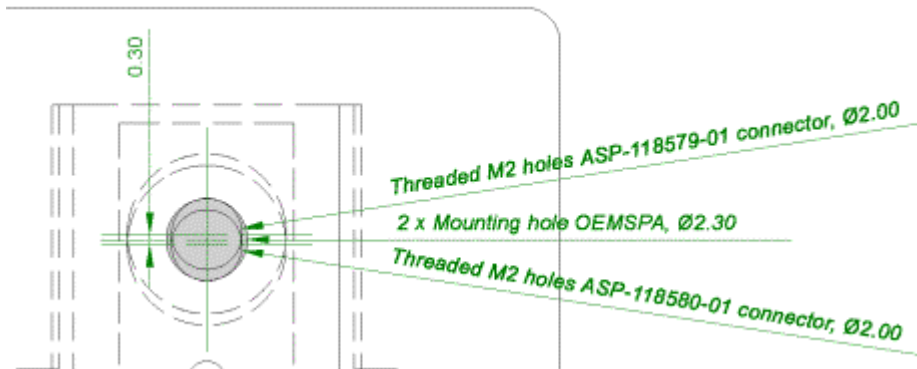

5.2 Using the J2/J3 board-to-board connectors

The board-to-board connector should be a 1 mm pitch one-piece part connector. The recommended manufacture is Samtec with many connector options available; see section 4.2.1.1. Chapter 2 contains more information about the connector and the electrical interface.

5.2.1 Suitable one-piece part connectors

5.2.2 Double row ASP-118580-01 / ASP-118581-01 connectors

This connector is a double row connector and connects both J2 and J3. It connector has a height of 3.0 mm and this has to be considered if components are to be mounted on the motherboard under the board. The connector is also available with a height of 6.0 mm and 10.0 mm (The FSI-120 serie from Samtec).

There are alignment pins on the bottom side of the connector.

The connector is available with M2 threaded inserts (ASP-118580-01) that fit the mounting holes on the board. You may screw the board directly into these inserts. If you want to have a tighter and more secure mounting you may use longer screws and secure it using a nut on the backside of the motherboard.

Another way to mount the module is to use press-fit nuts on the motherboard and skip the M2 threads on the connector (ASP-118581-01), see section 4.3 for more information about press-fit nuts.

Samtec order number	Quote number	Equivalent part	Package	Remark
REF-120021-01	55392	FSI-120-03-G-D-AB	Tube	Align pin on bottom side only
REF-120021-02	55392	FSI-120-03-G-D-AB-K-TR	Tape-n-Reel	Align pin on bottom side only
REF-120018-01	55392	FSI-120-03-G-D-M-AB	Tube	With M2 threaded inserts and align pin on bottom side only

REF-120018-02	55392	FSI-120-03-G-D-M-AB-K-TR	Tape-n-Reel	With M2 threaded inserts and align pin on bottom side only
---------------	-------	--------------------------	-------------	--

i When ordering connectors from Samtec or an official Samtec distributor, please use the REF order number and refer to the connectBlue global quote number for best price. For technical questions regarding the Samtec connectors please contact connectBlue or Samtec at Scandinavia@samtec.com.

See figure below for more information about the connector and necessary measurements on the motherboard. The large mounting holes on the motherboard are designed for press-fit nuts and could be smaller if press-fit nuts are not used.

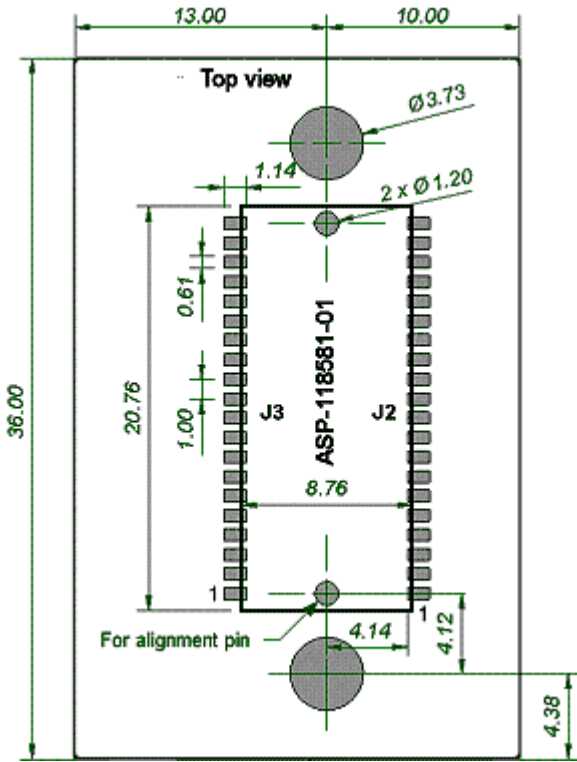

5.3 Using press-fit nuts for mounting

A press-fit nut is pressed into the PCB from the bottom side with a special press tool. M2 sized press-fit nuts are suitable for the modules (see figure below) and are manufactured by PEM Fastening Systems, www.pemnet.com, part no KFS2-M2. Be careful with the distance between the nuts regarding alignment.

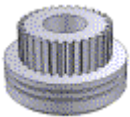

Spacer-pipes are recommended to use between the PCBs when press-fit nuts are used.

5.4 Recommended M2 screw

If a double-row connector with threaded inserts or press-fit nuts are used, then recommended for mounting of modules is a ISO 7380 M2 compatible screw. A suitable screw is the BN6404 from Bossard, www.bossard.com, with TORX T6 head cap. See figure below.

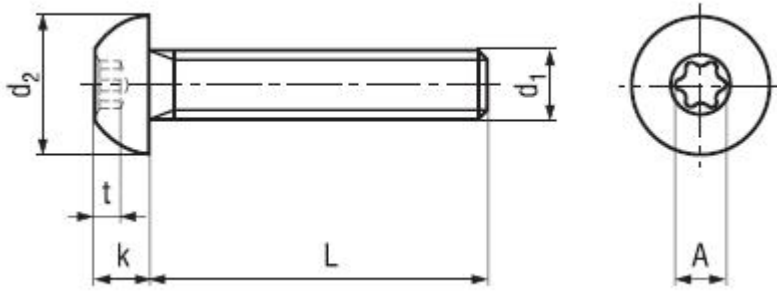

Parameter	Value	Unit
d2	3.5	mm
k max	1.3	mm
t max	0.8	mm
A	2.0	mm



If other type of screw is used please ensure that d_2 is less than 3.8 mm otherwise components near the mounting holes can be damaged.

5.5 Antenna issues

The unit cannot be mounted arbitrary, because of the radio communication. The unit with an internal surface mounted antenna (cB-OWL253 and cB-OWS451) cannot be mounted in a metal enclosure. No metal casing or plastics using metal flakes should be used, avoid also metallic based paint or lacquer. Keep a minimum clearance of 10 mm between the antenna and the casing. Keep 10 mm free space from metal around the antenna. If a metal enclosure is required, one of the external antenna options has to be used. See section 3.2 for more information on the antenna options available.

6 WLAN information

In the tables below you can find information about WLAN properties.

Parameter	Data
Radio	Redpine Signals RS9110 + Airoha 8230
RF output power	802.11b (CCK): +20dBm (typ.)
	802.11g (OFDM): +17dBm (typ.)
	802.11a (OFDM): +15dBm (typ.)
Receiver sensitivity	See table below
Receive input level (max)	-10 dBm
Output frequency	2.412 - 2.462 GHz, channel 1 - 11
	5 MHz channel separation
	5.180 - 5.240 GHz, U-NII-1, channel 36, 40, 44, 48
	20 MHz channel separation
Bluetooth co-existence	CSR traditional 3-wire

6.1 Radio sensitivity OFDM

Data rate	802.11gn (channel 6, 2437MHz, dBm)	802.11an (channel 36, 5180MHz, dBm)
MCS7	-69	-68
MCS6	-70	-70
MCS5	-72	-72
MCS4	-76	-76
MCS3	-79	-79
MCS2	-82	-82
MCS1	-84	-83
MCS0	-87	-86
54	-73	-72
48	-75	-73
36	-78	-78
24	-83	-80
18	-85	-83
12	-87	-85
9	-88	-86
6	-89	-87

6.2 Radio sensitivity DSSS

Data rate	802.11b (channel 6, 2437MHz, dBm)
11	-86
5.5	-89
2	-91
1	-94

7 Regulatory information



In progress

The qualification stated below is not yet applicable. They are currently included only to show what certifications will apply for the product after the certification process has been completed.

7.1 Limitations

With current type approvals the module is allowed to operate only on the 2.4 GHz ISM band and on the 5 GHz U-NII band 1.

7.2 Declaration of conformity



We, connectBlue AB, of
Norra Vallgatan 64 3V
SE-211 22 Malmö, Sweden

declare under our sole responsibility that our products:

- cB-OWL253i
- cB-OWL253x
- cB-OWS451i
- cB-OWS451x

to which this declaration relates, conforms to the following product specifications:

R&TTE Directive 1999/5/EC

EN 300 328 V1.7.1 (2006-10)

EN 301 893 V1.5.1 (2008-12)

EN 301 489-1 V1.8.1 (2008-04)

EN 301 489-17 V1.3.2 (2007-06)

EN 61000-6-2 (2005)

Safety Compliance

EN 60950-1:2006 and/or IEC 60950-1:2006

EN 60950-1/A11:2004 + Corrigendum:2004

Medical Electrical Equipment

IEC 60601-1-2 (2007) (for single antenna configurations)

2010-xx-xx Malmö, Sweden

Mats Andersson
CTO of connectBlue AB

If a cB-OWL253 or a cB-OWS451 is used within EU a notification may be necessary to be made to each of the national authorities responsible for radio spectrum management of the intention to place radio equipment that uses frequency bands whose use is not harmonized throughout the EU, on its national market.

More information at: <http://europa.eu.int/comm/enterprise/rtte/gener.htm>

7.3 IC and FCC compliance

See [Product variants](#) for information about the different product variants.

7.3.1 IC Compliance

Operation is subject to the following two conditions:

1. this device may not cause harmful interference,
2. this device must accept any interference received, including interference that may cause undesired operation.

This device has been designed to operate with an antenna having a maximum gain of +8.5 dBi. Having a higher gain is strictly prohibited per regulations of Industry Canada. The required antenna impedance is 50 ohms. To reduce potential radio interference to other users, the antenna type and its gain should be so chosen that the equivalent isotropic radiated power (EIRP) is not more than that required for successful communication. The installer of this radio equipment must ensure that the antenna is located or pointed such that it does not emit RF field in excess of Health Canada limits for the general population; consult Safety Code 6, obtainable from Health Canada's website <http://www.hc-sc.gc.ca/rpb>.

7.3.2 FCC statement

This device complies with Part 15 of the FCC Rules. Operation is subject to the following two conditions: (1) this device may not cause harmful interference, and (2) this device must accept any interference received, including interference that may cause undesired operation.



This equipment has been tested and found to comply with the limits for a Class B digital device, pursuant to Part 15 of the FCC Rules. These limits are designed to provide reasonable protection against harmful interference in a residential installation. This equipment generates, uses and can radiate radio frequency energy and, if not installed and used in accordance with the instructions, may cause harmful interference to radio communications. However, there is no guarantee that interference will not occur in a particular installation. If this equipment does cause harmful interference to radio or television reception, which can be determined by turning the equipment off and on, the user is encouraged to try to correct the interference by one or more of the following measures:

- Reorient or relocate the receiving antenna
- Increase the separation between the equipment and receiver
- Connect the equipment into an outlet on a circuit different from that to which the receiver is connected

Consult the dealer or an experienced radio/TV technician for help.

7.3.2.1 Labeling requirements for end product

For an end product using the product there MUST be a label containing, at least, the following information:

This device contains

FCC ID: PVH0942
IC: 5325A-0942

The label must be affixed on an exterior surface of the end product such that it will be visible upon inspection in compliance with the modular approval guidelines developed by the FCC. In accordance with 47 CFR § 15.19 the end product shall bear the following statement in a conspicuous location on the device:

"This device complies with Part 15 of the FCC Rules. Operation is subject to the following two conditions:

1. this device may not cause harmful interference, and
2. this device must accept any interference received, including interference that may cause undesired operation."

When the device is so small or for such use that it is not practicable to place the statement above on it, the information shall be placed in a prominent location in the instruction manual or pamphlet supplied to the user or, alternatively, shall be placed on the container in which the device is marketed. However, the FCC ID label must be displayed on the device. In case, where the final product will be installed in locations where the end-user is not able to see the FCC ID and/or this statement, the FCC ID and the statement shall also be included in the end-product manual.

7.3.2.2 Antenna

Our module types cB-OWL253 and cB-OWS451 are for OEM integrations only. In the end-user product the module shall be professionally installed in such a manner that only the authorized antennas can be used.

7.3.2.3 Caution



Any changes or modifications NOT explicitly APPROVED by connectBlue AB could cause the module to cease to comply with FCC rules part 15, and thus void the user's authority to operate the equipment.



Within the 5180 to 5240 MHz band (5 GHz radio channels 34 to 48) the module types cB-OWL253 and cB-OWS451 are restricted to indoor operations.



§15.407 statement; in case of absence of information to transmit or operational failure the modules types cB-OWL253 and cB-OWS451 will automatically discontinue transmission.

7.3.2.4 Ad-hoc frequencies

Module types cB-OWL253 and cB-OWS451 when operating under the definition of a client in 47 CFR §15.202 is preconfigured to use the most restrictive regulatory domain. For this reason the available operating frequency range is limited to channel 1 - 11 (2412 - 2462 MHz) for IEEE802.11b/g. For IEEE802.11a the available operating frequency range is limited to channels 36 - 48 (5180 - 5240 MHz).

7.3.2.5 RF-exposure statement

This modular transmitter MUST have a separation distance of at least 20 cm between the antenna and the body of the user or nearby persons.

If the radio module is installed in a laptop display, transmission MUST be prevented if the lid is closed to ensure that the minimum distance of 20 cm between the user and the transmitting antenna is maintained.

Any notification to the end user of installation or removal instructions about the integrated radio module is NOT allowed.

7.4 UL listing information

If a customer intends to UL list a product including the cB-OWL253 or cB-OWS451 based on the PCB cB-0942 this information is useful. The printed circuit board is produced according to the following specification:

- UL recognized ZPMV2 min. 130 °C flame class V-0 or better.

7.5 Compliance with RoHS directive

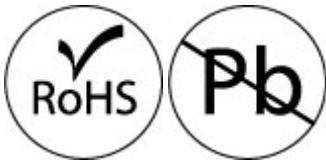

The cB-OWL253 and cB-OWS451 are produced according to the RoHS (Restriction of the use of certain Hazardous Substances in electrical and electronic equipment) directive and complies with the directive.

8 Guidelines for efficient and safe use

8.1 General

Read this information before using your cB-OWL253 or cB-OWS451 module.

For any exceptions, due to national requirements or limitations, when using your cB-OWL253 or cB-OWS451 module, please contact connectBlue AB.



Changes or modifications to the product not expressly approved by connectBlue AB will void the user's authority to operate the equipment.

8.2 Product care

- Do not expose your product to liquid or moisture.
- Do not expose your product to extreme hot or cold temperature.
- Do not expose your product to lit candles, cigarettes, cigars, open flames, etc.
- Do not drop, throw or try to bend your product since rough treatment could damage your product.
- Do not attempt to disassemble your product. Doing so will void warranty. The product does not contain consumer serviceable or replaceable components. Service should only be performed by connectBlue AB.
- Do not paint your product as the paint could prevent normal use.
- If you will not be using your product for a while, store it in a place that is dry, free from damp, dust and extreme heat and cold.
- The clearance and creepage distances required by the end product must be withheld when the module is installed.
- The cooling of the end product shall not negatively be influenced by the installation of the module when the module is installed.

8.3 Radio frequency exposure

The cB-OWL253 and cB-OWS451 module contains a small radio transmitter and receiver.

During communication with other WLAN products the cB-OWL253 and cB-OWS451 module receives and transmits radio frequency (RF) electromagnetic fields (microwaves) in the frequency range 2412 - 2462 MHz and 5180 - 5240 MHz. The output power of the radio transmitter is very low.

When using the cB-OWL253 or cB-OWS451 module, you will be exposed to some of the transmitted RF energy. This exposure is well below the prescribed limits in all national and international RF safety standards and regulations.

8.4 Electronic equipment

Most modern electronic equipment, for example, in hospitals and cars, is shielded from RF energy. However, certain electronic equipment is not. Therefore:



This equipment emits RF energy in the ISM (Industrial, Scientific, Medical) band. Please insure that all medical devices used in proximity to this device meet appropriate susceptibility specifications for this type of RF energy.

8.5 Potentially explosive atmospheres

Turn off your electronic device before entering an area with potentially explosive atmosphere. It is rare, but your electronic device could generate sparks. Sparks in such areas could cause an explosion or fire resulting in bodily injury or even death.

Areas with a potentially explosive atmosphere are often, but not always, clearly marked. They include fuelling areas, such as petrol station, below deck on boats, fuel or chemical transfer or storage facilities, and areas where the air contains chemicals or particles, such as grain, dust, or metal powders.

8.6 Safety compliance

In order to fulfill the safety standard EN 60950-1:2006 the cB-OWL253 and cB-OWS451 must be supplied by a Class-2 Limited Power Source.

8.6.1 Power supply

- Connect your power supply only to designated power-sources as marked on the product.
- Make sure all cords and cable are positioned so that they will not be stepped on, tripped over or otherwise subject to damage or stress.
- To reduce risk of electric shock, unplug the unit from any power source before attempting to clean it.

9 Design examples

9.1 Basic design