

PowerFlex® 520-Series AC Drives



The Next Generation of Powerful Performance. Flexible Control.



LISTEN.
THINK.
SOLVE.®

PowerFlex 520-Series AC Drives

The Next Generation of Powerful Performance. Flexible Control.

The Allen-Bradley® PowerFlex 520-Series of AC drives is the next generation of compact drives offering a variety of features and time-saving benefits to help meet a wide range of global applications. PowerFlex® 523 AC drives are ideal for standalone machines and provide motor control for applications up to 11 kW/15 Hp. PowerFlex® 525 AC drives are ideal for networked machines and simple system integration, offering standard features including embedded EtherNet/IP™, safety and performance up to 22 kW/30 Hp.

By combining an innovative design, several motor control options, installation flexibility, communications, energy savings and ease of programming, PowerFlex 520-Series AC drives can help you increase your system performance and reduce your time to design and deliver better machines.





Designed for ease of use and flexible installation, PowerFlex 520-Series AC drives can help you maximize your productivity.

- Power ratings
 - PowerFlex 523 AC drives: **0.2...11 kW / 0.25...15 Hp** in global voltage classes from 100-600V
 - PowerFlex 525 AC drives: **0.4...22 kW / 0.5...30 Hp** in global voltage classes from 100-600V
- The **modular design** features an innovative removable control module that allows installation and configuration at the same time to help increase productivity
- An **embedded port** for EtherNet/IP for the PowerFlex 525 AC drive supports seamless integration into the Logix environment and EtherNet/IP networks
- An optional **dual port EtherNet/IP** card supports ring topologies and device level ring (DLR) functionality, which can help provide network resiliency
- PowerFlex 525 AC drives can help protect personnel with **embedded Safe Torque-Off**
- **Software** and **tools** help simplify programming
- An integral human interface module (HIM) supports **multiple languages** and features descriptive **QuickView™** scrolling text to help explain parameters and codes, easing configuration
- **AppView™** application parameter groups help speed configuration for many common applications
- **CustomView™** configuration helps speed machine commissioning with your own defined group of parameters
- Economizer control mode and energy monitoring features can help **reduce energy costs**
- Drives operate in **ambient temperatures** from -20°C (-4°F) to 50°C (122°F). With current derating and a control module fan kit, up to 70°C (158°F)
- A **range of motor control options** support a variety of applications
- A **compact footprint** provides flexible installation options and helps save space inside of a panel



A modular design allows you to install a power module and configure a control module at the same time.



Maintain a compact footprint when accessory cards are installed.

MainsFree™ programming allows configuration files to be uploaded and downloaded to the control module via a USB connection.



Innovative, Modular Design

Versatile Installation

PowerFlex 520-Series AC drives are made up of two modules that can be detached for simultaneous and independent wiring installation and software configuration. This innovative design allows you to begin mounting the power modules while configuration of the control modules is performed elsewhere, helping speed up installation.

You can download drive configuration files to the control module while the power module is installed using MainsFree configuration. Simply connect a PowerFlex 523 or 525 AC drive to your PC with a standard USB cable and upload or download configuration files using the onboard transfer application.

Flexible mounting options, a compact size and a high temperature tolerance can allow PowerFlex 520-Series AC drives to help meet your needs for flexibility and space savings.

Adding accessory cards does not affect the footprint of the drives. Additional panel space can be saved when installing these drives with the 50mm (1.96 in) clearance requirement at the top and bottom of drive. For further flexibility, these drives can be installed vertically or horizontally as well as side by side in either orientation. A control module fan kit is required for horizontal mounting.

Generous venting allows PowerFlex 520-Series AC drives to operate in high ambient temperatures of up to 50°C (122°F) without current derating and 60°C (140°F) with current derating. These drives can run in temperatures up to 70°C (158°F) with current derating using a control module fan kit.

Conformal coating to IEC 60721 3C2 standards over the circuitry also helps improve the drive's robustness.



A control module fan kit allows PowerFlex 520-Series AC drives to run in temperatures up to 70°C (158°F) with current derating.



Control module fan kits allow you to mount PowerFlex 520-Series AC drives side by side and horizontally, saving panel space.

Ease of Programming

Tools Help Make It Simple

There are several ways to quickly and easily configure PowerFlex 520-Series AC drives. From the integral human interface module (HIM), to Connected Components Workbench™ software or the Studio 5000 Logix Designer™ application, we can provide you with powerful, intuitive tools to help enhance your user experience and reduce your development time so you can deliver faster and more efficiently.



Five-digit, 16-segment liquid crystal display (LCD) HIM with scrolling descriptive text.

Support for multiple languages.

Quickly navigate menus and speed configuration with the integral keypad.

PowerFlex 520-Series AC drives help make configuration easier with an integral LCD human interface module (HIM) that displays parameter numbers and other codes followed by simple descriptions in scrolling text. These QuickView details help provide meaningful explanations, saving time by reducing the need to look up parameters and codes in a manual. The HIM also supports multiple languages, which can be quickly selected through the integral keypad. For an interactive demonstration of how this works, visit www.ab.com/powerflex525.

Speed Configuration

PowerFlex 520-Series AC drives can help you configure drives faster with intuitive and convenient AppView and CustomView application-specific parameter tools.

AppView configuration, which is available through the integral HIM, Connected Components Workbench software and the Studio 5000 Logix Designer application, provides parameter groups for several of the most common applications, including conveyors, mixers, compressors, pumps and blowers. With the settings to run these applications already in place, you can get your machine up and running faster, increasing your productivity.

Customize your machine and further reduce future design and development time by quickly defining your own group of parameters using the CustomView tool. This configuration option, which is also available through all the same drive configuration tools, allows you to customize your configuration by adding or removing parameters from an AppView group or save your own custom group of parameters.

AppView group configuration provides parameters for common applications. With a few clicks, save time by seeing only the parameters most relevant to an application.

Parameter	Value	Units	Internal Value
req	0.00	Hz	0
Language	English		1
V	230	V	230
Hz	60	Hz	60
A	0.2	A	2
A	0.2	A	2
	4		4

Create and save a user defined group of parameters.

Select parameters from the parameter list.

Move parameters by clicking the "add" or "remove" button.

Parameters appear in the CustomView window.

Edit Custom Group

Filter Value:

Group Name:

Group:

#	Name
30	Language
31	Motor NP Volts
32	Motor NP Hertz
33	Motor OL Current
34	Motor NP FLA
35	Motor NP Poles
36	Motor NP RPM
37	Motor NP Power
39	Torque Perf Mode
40	Autotune
41	Accel Time 1

Custom Group

#	Name
30	Language

Buttons: Add ->, <- Remove

Buttons: OK, Cancel

Drive Configuration

Connected Components Workbench Software

Connected Components Workbench software can help you get your drives up and running with an intuitive interface and startup wizards. This free software uses Rockwell Automation and Microsoft® Visual Studio® technologies for fast and easy drive configuration.

- Start up wizards to help speed up configuration
- Configuration and control of drives over communication networks

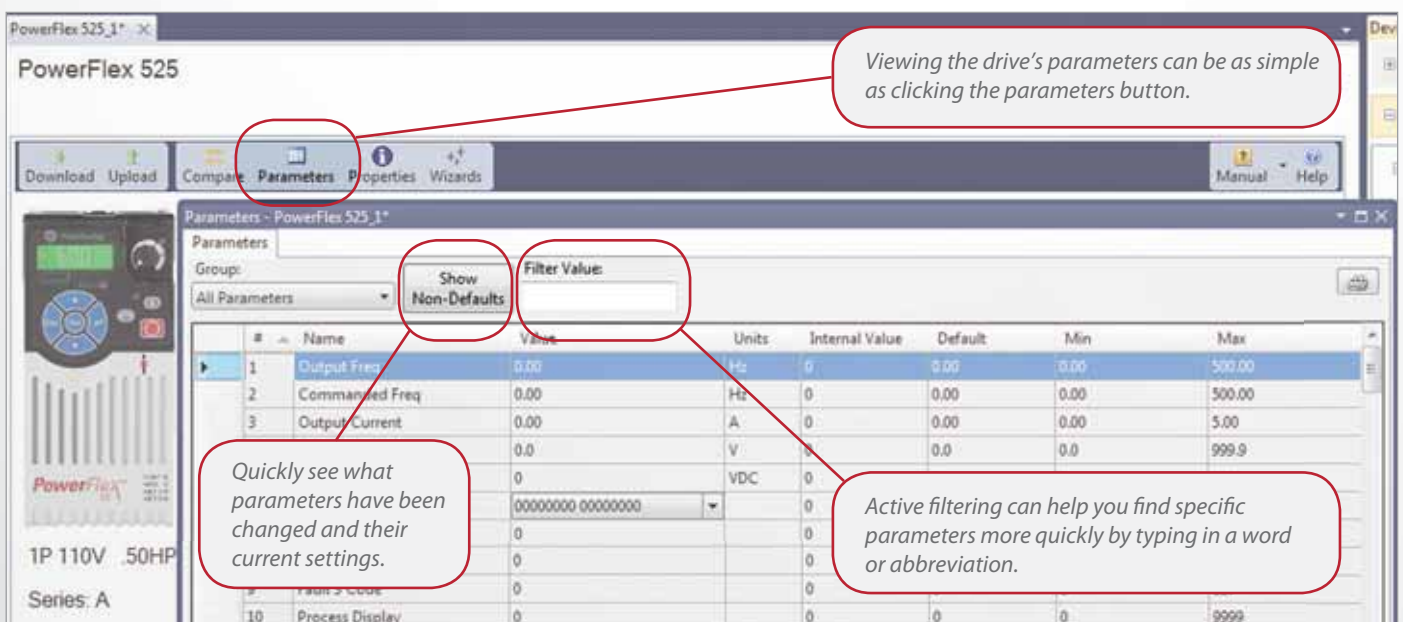
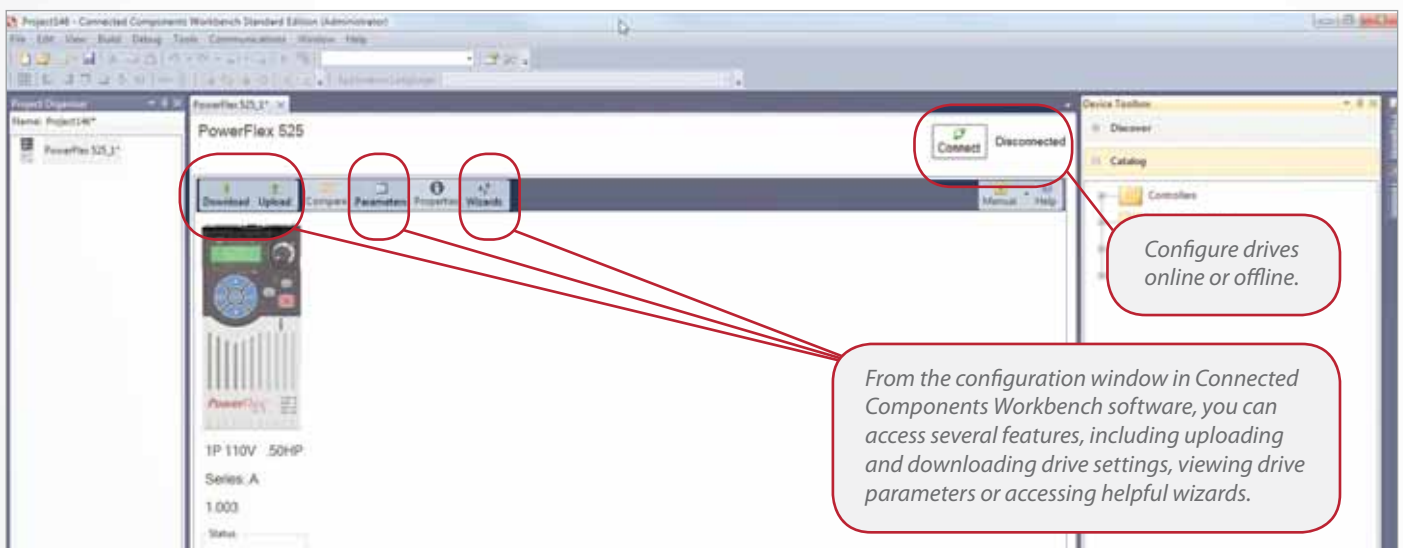

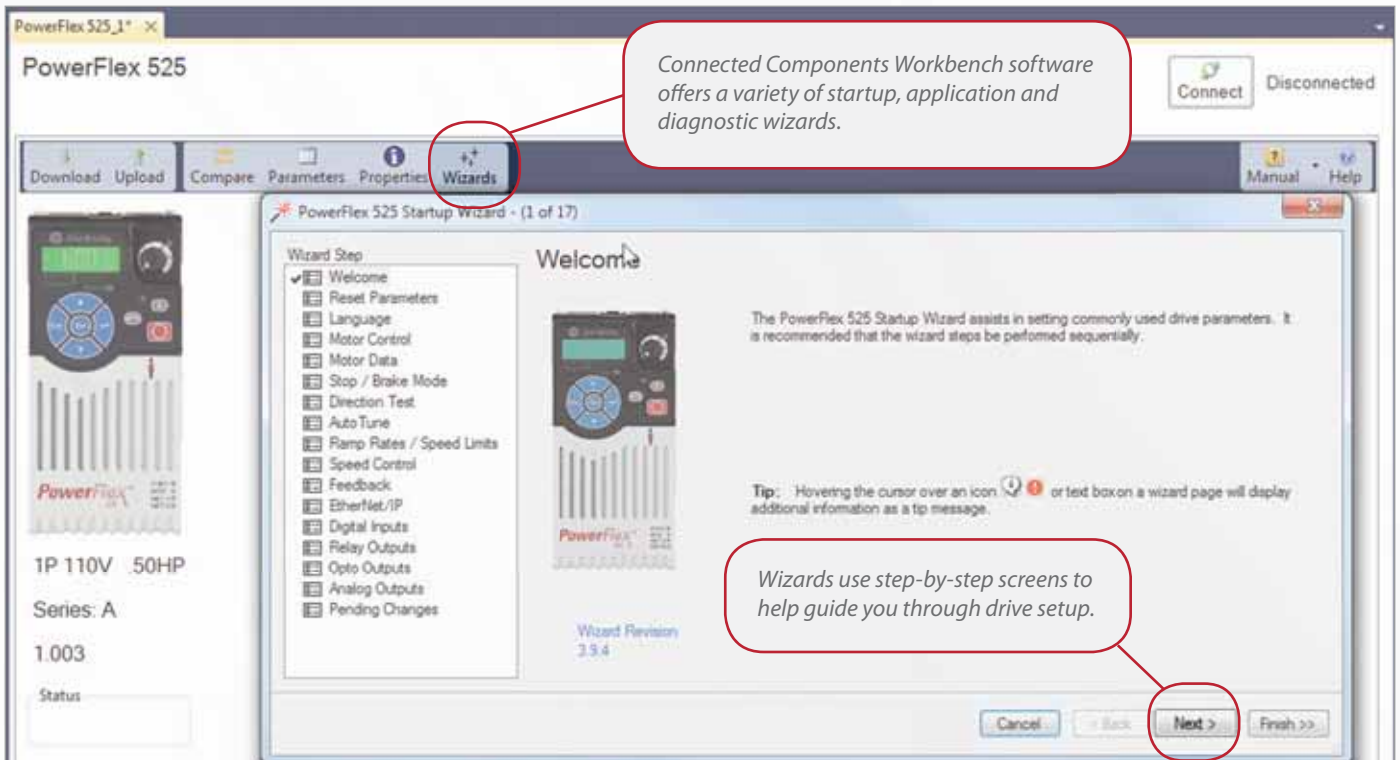

Connected Components Workbench software can help minimize your machine design and development time and is ideal for standalone applications. You can upload and download configurations over a USB connection and configure drives over EtherNet/IP, DeviceNet® or other open industrial networks. Connected Components Workbench software supports PowerFlex drives as well as Micro800™ programmable controllers and PanelView™ component graphic terminals.

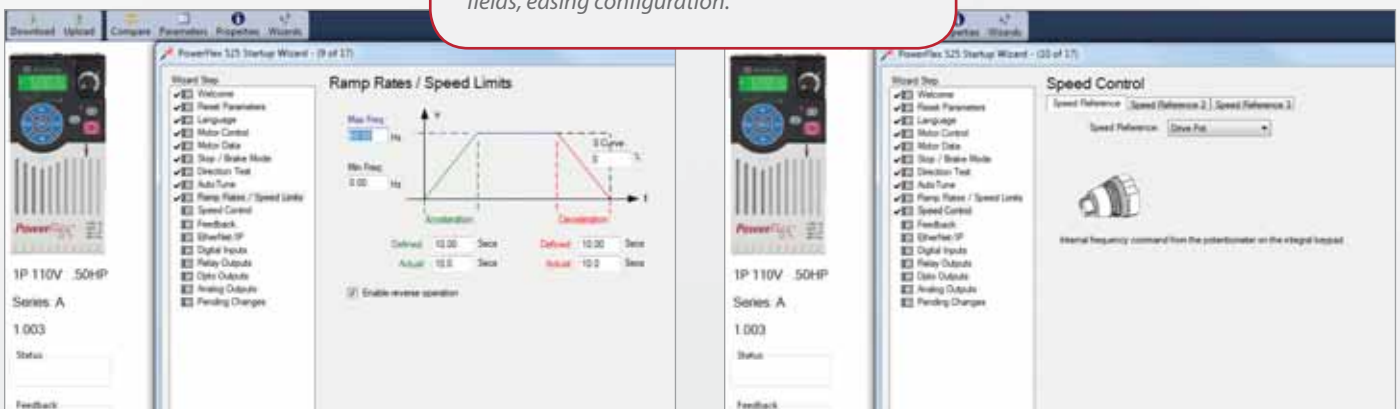
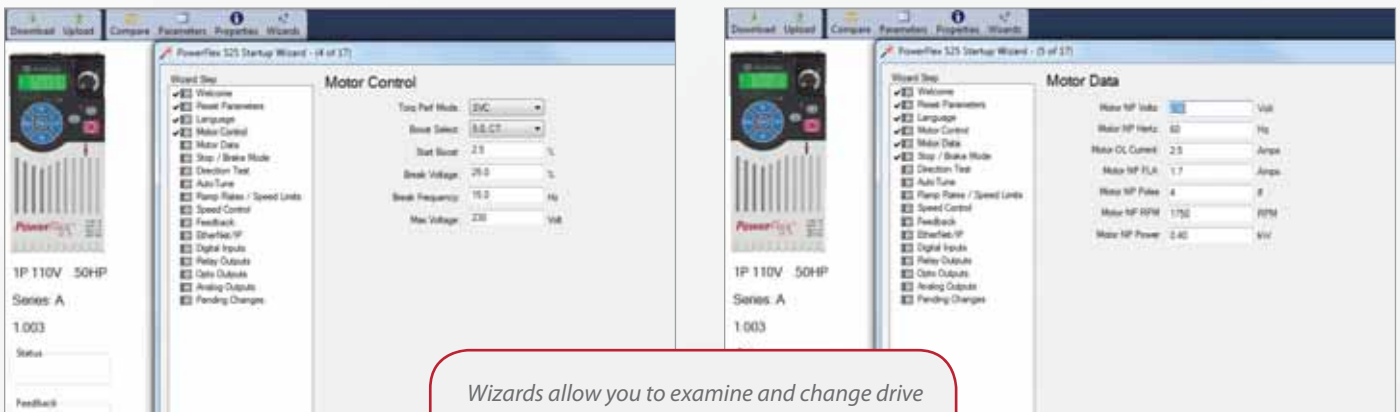

Premier Integration

Streamline Development, Use and Maintenance

The power of Rockwell Automation Integrated Architecture™ combined with the communication capabilities of PowerFlex 520-Series AC drives can offer an exceptional level of integration that can reduce development costs and time.

You can benefit from Premier Integration with PowerFlex 520-Series AC drives and Allen-Bradley programmable automation controllers (PACs). The Studio 5000 Logix Designer application can help reduce programming time by automatically populating drive parameters in the controller memory as controller tags.

PowerFlex drives are placed in the controller I/O tree, minimizing mismatch errors and further reducing configuration time. Using Premier Integration can help you reduce engineering time and related costs while improving the configuration, control and collection of data.

Automatic Device Configuration (ADC) is another productivity enhancing feature available with the Studio 5000 Logix Designer application and PowerFlex 525 AC drives with EtherNet/IP. This feature allows a Logix controller to automatically detect a replaced PowerFlex 520-Series AC drive* and download firmware and all configuration parameters using an Allen-Bradley Stratix™ 5700, 6000 or 8000 switch, which automatically assigns the drive's IP address. This time-saving feature can help minimize the need for manual reconfiguration.

- A single software environment to configure your entire system can help save time and money by allowing you to work more productively
- Seamless integration into the Logix environment, reducing programming time
- Automatic Device Configuration downloads configuration parameters to a replaced drive, helping save time to repair

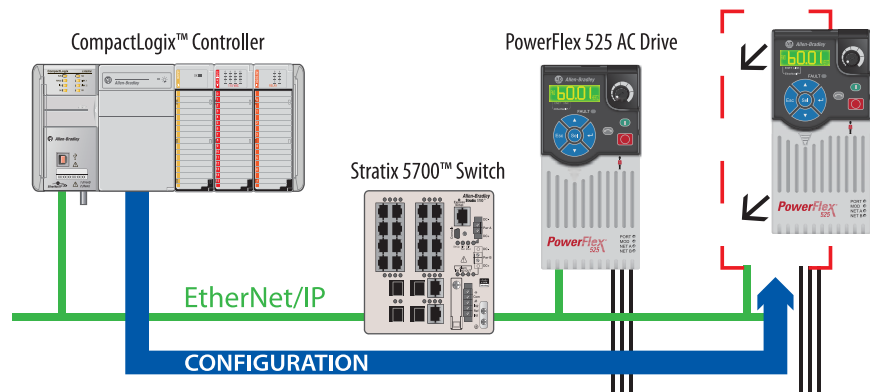

Automatic Device Configuration (ADC) allows a Logix controller to automatically detect a replaced PowerFlex 525 or 523* AC drive and download all configuration parameters. A Stratix 5700, 6000 or 8000 switch can automatically assign the drive's IP address.

*PowerFlex 523 AC drives require a dual port EtherNet/IP communication card for ADC.



Studio 5000 Logix Designer Application

The Studio 5000 Logix Designer application allows you to configure your PowerFlex drives similarly to previous versions of RSLogix 5000™ software. Use a single software tool to help reduce your programming time, ease startup and commissioning and streamline diagnostics.

PowerFlex 520-Series AC drives are compatible with RSLogix 5000 (v17 and higher)

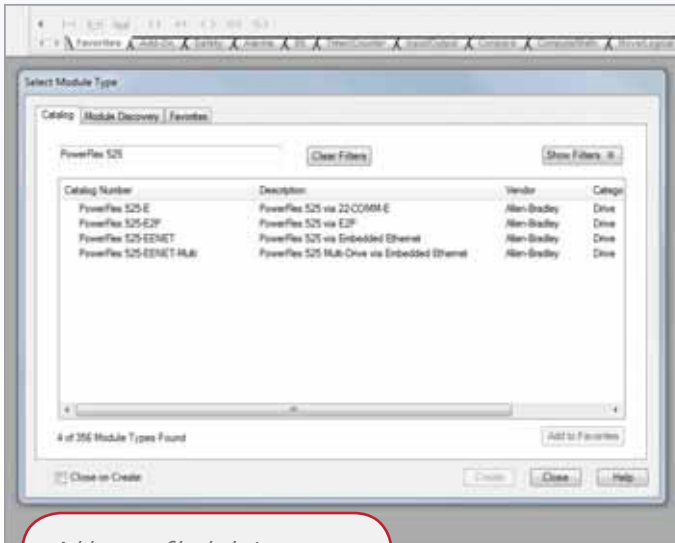

Add-on profiles help integrate PowerFlex 525 AC drives into the Logix environment.



Premier Integration with PowerFlex 525 AC drives helps save development time and makes systems easier to maintain.

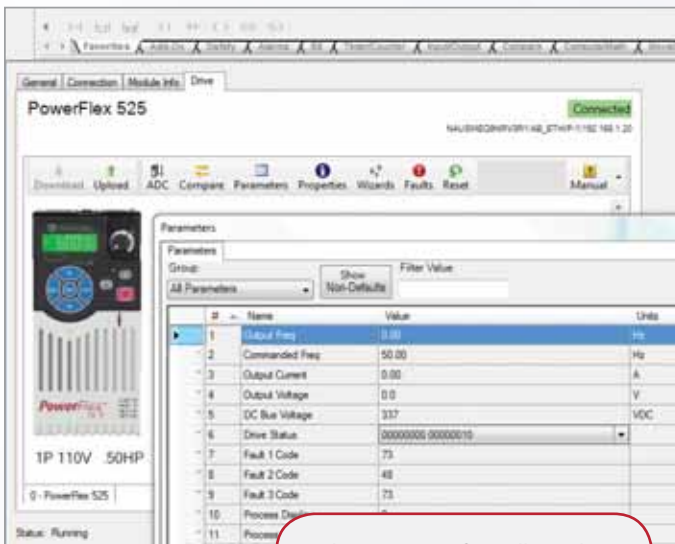

The Logix interface allows the dynamic selection of drive parameters transmitted over the network.

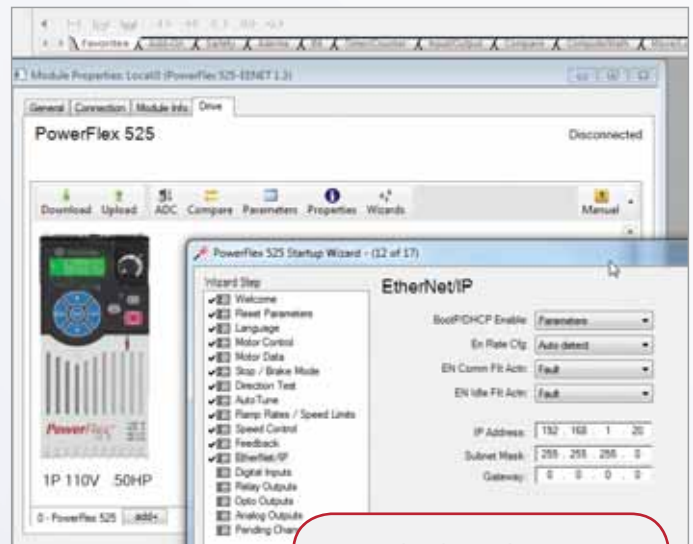

A wizard in the Studio 5000 Logix Designer application can help you configure your PowerFlex 525 AC drives EtherNet/IP settings.

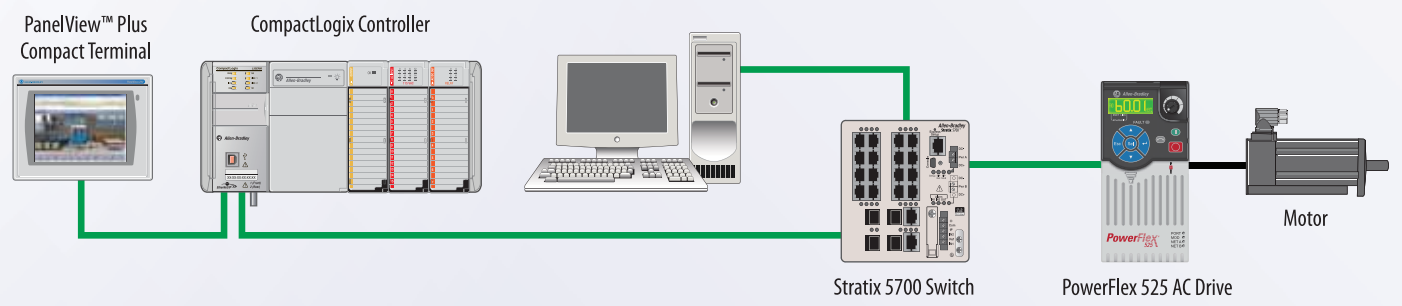

PowerFlex 525 AC drives and the Integrated Architecture system offer you the flexibility to find the ideal solution for your application.

Communications

A Wide Variety of Options

The seamless exchange of information between drives and operators helps save time and increase efficiency, and PowerFlex 523 and 525 AC drives offer features that can help you easily manage data throughout your operations.

For networked applications, PowerFlex 525 AC drives have an embedded port for EtherNet/IP that allows you to easily configure, control and collect data over the network. An optional dual port EtherNet/IP card for PowerFlex 520-Series AC drives supports linear and ring network topologies.

The dual port communication adapter offers device level ring (DLR) functionality, which can help increase system resiliency in the case of the loss of one network connection. DLR technology, which is an ODVA standard, helps reduce configuration time and costs by minimizing the number of managed switches and reducing cabling needs while allowing users to create a single network ring that connects all components at the device level.

- Embedded DSI port standard
- PowerFlex 525 AC drives include an embedded port for EtherNet/IP
- Dual port EtherNet/IP option card
- DeviceNet communications option card

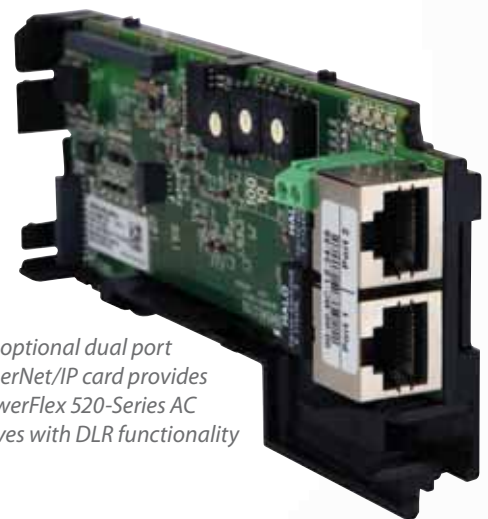

An optional dual port EtherNet/IP card provides PowerFlex 520-Series AC drives with DLR functionality

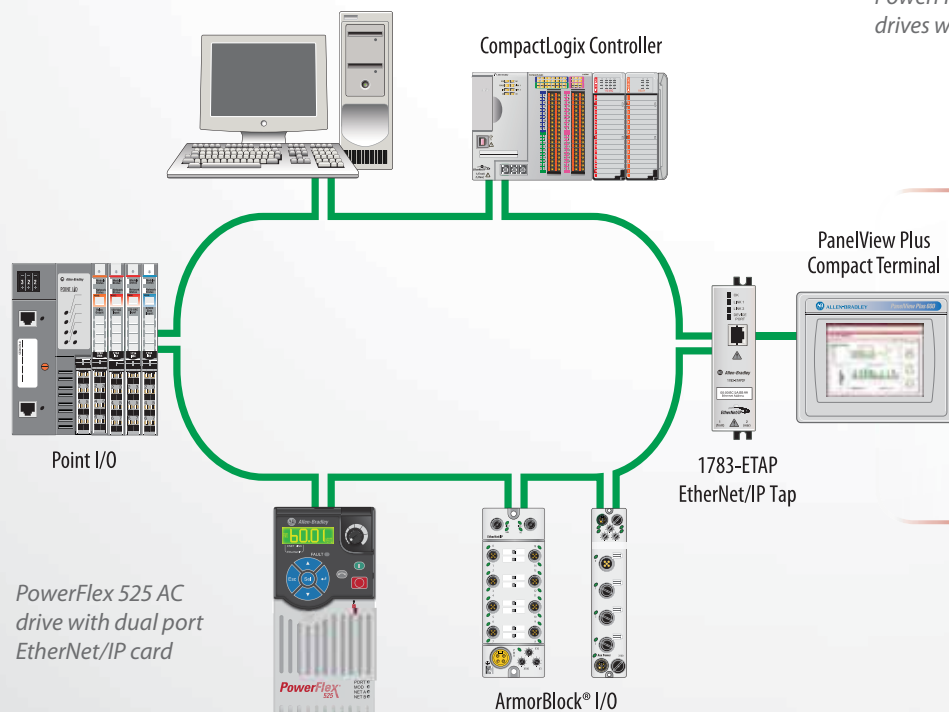

DLR is an ODVA standard and requires no additional hardware to implement. This provides network resiliency.

Flexible Control

Suitable for Many Applications

PowerFlex 520-Series AC drives provide a range of motor control options for a vast array of applications, including volts per hertz, sensorless vector control and Economizer mode in sensorless vector control. PowerFlex 525 AC drives can also provide closed-loop velocity vector control and permanent magnet motor control* in addition to closed-loop feedback for positioning capability with an optional encoder card.

For applications requiring stops at designated positions regardless of the speed or load, and without the help of an encoder, PowerFlex 520-Series AC drives utilize PointStop™ positioning control. This set of parameters directs the drive to adjust its deceleration rate based on its speed when a command is initiated, allowing a motor to stop in a consistent position.

And for position control applications such as diverters, smart conveyors and packaging machines, PowerFlex 525 AC drives provide point-to-point positioning in a cost effective and flexible package to help meet your needs.

- Volts per hertz
- Sensorless vector control
- Economizer mode in sensorless vector control
- Closed loop velocity vector control for PowerFlex 525 AC drives
- Permanent magnet motor control for PowerFlex 525 AC drives

** Permanent magnet motor control is scheduled for a future firmware release*



Energy Savings

Improved motor control performance boosts efficiency, and PowerFlex 520-Series AC drives can provide a measurable impact on energy use.

In addition to the inherent energy savings associated with using a variable frequency drive, PowerFlex 520-Series AC drives offer additional savings in Economizer mode when using sensorless vector control. Economizer measures power consumption and optimizes current output to meet the demands of the application.

PowerFlex 520-Series AC drives can also monitor and report energy usage data and provide that information in a standard format to help you develop and manage an energy strategy for your operations.

- Adjust energy use and help reduce costs with Economizer mode
- Monitors and reports energy usage to help make data-driven decisions



PowerFlex 523 AC Drive

PowerFlex 523 AC drives are designed to help reduce installation and configuration time while offering the control you need for your application. These drives offer convenient programming features and installation flexibility in a cost-effective solution.



Power ratings of 0.2...11 kW / 0.25...15 Hp in global voltage classes of 120, 240, 480 and 600 volts. Available in four frame sizes (A, B, C and D).

Volts per hertz, sensorless vector control and Economizer mode in sensorless vector control to meet a wide range of applications.

An embedded DSI port comes standard. With a communication adapter card, PowerFlex 523 AC drives support multi-drive networking, connecting up to five PowerFlex AC drives on one node.

- 5 digital inputs (24V DC, 4 programmable)
- 1 analog input (unipolar voltage or current)
- 1 relay (form C)

Product shown is actual size, PowerFlex 523 AC drive Frame A



PowerFlex 525 AC Drive

PowerFlex 525 AC drives are ideal for networked applications requiring more motor control options, embedded EtherNet/IP, energy savings and standard safety features. When you combine PowerFlex 525 AC drives with EtherNet/IP, you can seamlessly integrate into your system architecture and standardize on a single software tool.



Power ratings of 0.4...22 kW / 0.5...30 Hp in global voltage classes of 120, 240, 480 and 600 volts. Available in five frame sizes (A, B, C, D and E).

Volts per hertz, sensorless vector control, closed loop velocity vector control and permanent magnet motor control* to meet a wide range of applications.

An embedded port for EtherNet/IP supports seamless integration into the Logix environment and EtherNet/IP networks.

An embedded DSI port supports multi-drive networking, connecting up to five PowerFlex AC drives on one node.

- 7 digital inputs (24V DC, 6 programmable)
- 2 analog inputs (1 bipolar voltage, 1 current)
- 2 digital outputs
- 1 analog output (1 unipolar voltage or current)
- 2 relays (1 form A relay & 1 form B relay; 24V DC, 120V AC, 240V AC)

Embedded Safe Torque-Off can help to protect personnel.

Product shown is actual size,
PowerFlex 525 AC drive Frame A



PowerFlex 520-Series AC Drives

Maximize System Performance

Control

- Volts per hertz
- Sensorless vector control (SVC)
- Closed loop velocity vector control for PowerFlex 525 AC drives
- Permanent magnet motor control* for PowerFlex 525 AC drives
- Multiple preset speeds with programmable control through digital inputs or communications

Positioning Control

- PointStop positioning control stops motor load in a consistent position without encoder feedback
- Closed loop feedback with an optional encoder card for PowerFlex 525 AC drives
- Point-to-point positioning mode for PowerFlex 525 AC drives

Communications

- Built-in port for EtherNet/IP for PowerFlex 525 AC drives
- Embedded DSI port
- Dual port EtherNet/IP option card
- DeviceNet and PROFIBUS® option cards

Energy Savings

- Economizer mode in SVC adjusts current output to help reduce energy costs
- Energy data monitoring and reporting capability
- Permanent magnet motor control* for PowerFlex 525 AC drives

Hardware

- Modular design with removable control modules
- Same control module for the entire power range
- Built-in USB port uses standard USB cable
- Vertical, side-by-side mounting to reduce panel space
- Flexible, time-saving installation using DIN rail mounting with A, B and C frame drives
- Horizontal mounting with a control module fan kit
- Ambient operating temperatures from -20°C (-4°F) up to 70°C (158°F) with current derating and a control module fan kit
- IP20 NEMA/Open, IP30 NEMA/UL Type 1 (with conduit kit)
- EMC filtering embedded at 200V and 400V; optional EMC filtering available for all voltages
- Standard conformal coating IEC 60721 3C2 (chemical and gases only)

Programming and Commissioning

- Integral HIM supports multiple languages and features QuickView scrolling text
- Application specific parameter groups and customized application settings using AppView and CustomView tools
- Simplified configuration and MainsFree programming using standard USB cables
- Connected Components Workbench software for fast and easy drive configuration
- Premier Integration with the Logix control platform with the Studio 5000 Logix Designer application

** Permanent magnet motor control is scheduled for a future firmware release*

Help Protect Personnel with Embedded Safety

Safe Torque-Off is a standard safety feature of the PowerFlex 525 AC drive to help protect personnel and equipment. Integrated Safe Torque-Off suits several safety situations that require removing rotational power from the motor without powering down the drive.

Safe Torque-Off allows you to restart your application faster after a safety-related situation. The system, which meets ISO 13849-1 standards, provides safety ratings up to and including SIL2/PLd Cat 3.

Embedded safety can help lower your total system costs, boost machine availability and reduce downtime.

- **Safe Torque-Off functionality removes rotational power without powering down the drive, helping to reduce downtime**
- **Embedded safety reduces wiring and saves on installation space**
- **Rated SIL 2/PLd Cat 3 to meet many applications**

Technical Specifications

PowerFlex® 523 AC Drives		PowerFlex® 525 AC Drives												
Power Ratings	100 - 120V: 0.2...1.1 kW / 0.25...1.5 Hp 380 - 480V: 0.4...11 kW / 0.5...15 Hp	200 - 240V: 0.2...7.5 kW / 0.25...10 Hp 525 - 600V: 0.4...11 kW / 0.5...15 Hp	100 - 120V: 0.4...1.1 kW / 0.5...1.5 Hp 380 - 480V: 0.4...22 kW / 0.5...30 Hp	200 - 240V: 0.4...15 kW / 0.5...20 Hp 525 - 600V: 0.4...22 kW / 0.5...30 Hp										
Motor Control	Volts per hertz Sensorless vector control	Sensorless vector control with Economizer	Volts per hertz Sensorless vector control Closed loop velocity vector control	Sensorless vector control with Economizer Permanent magnet motor control*										
Application	Open loop speed regulation		Open loop speed regulation	Closed loop speed regulation										
Overload Capability	Heavy duty application: 150% for 60 seconds, 180% for 3 sec (200% programmable)		Normal duty application: 110% for 60 seconds, 150% for 3 sec Heavy duty application: 150% for 60 seconds, 180% for 3 sec (200% programmable)											
Input Specifications	1 phase voltage: 100 ... 120V/200 ... 240V Voltage: adjustable 0V to rated motor voltage; -15% / +10% voltage tolerance 3 phase voltage: 200 ... 240V/380 ... 480V/525 ... 600V frequency: 50 to 60 Hz Logic control ride through: >0.5 seconds, 2 seconds typical 1/2 DC bus operation (selectable) Maximum short circuit rating: 100,000 amps symmetrical		1 phase voltage: 100 ... 120V/200 ... 240V Voltage: adjustable 0V to rated motor voltage; -15% / +10% voltage tolerance 3 phase voltage: 200 ... 240V/380 ... 480V/525 ... 600V frequency: 50 to 60 Hz Logic control ride through: >0.5 seconds, 2 seconds typical 1/2 DC bus operation (selectable) Maximum short circuit rating: 100,000 amps symmetrical											
Output Voltage Range	Adjustable 0V to rated motor voltage	Intermittent current: 150% for 60 seconds	Adjustable 0V to rated motor voltage	Intermittent current: 150% for 60 seconds										
Frequency Range	Max output frequency 500 Hz	Input frequency variation 47 to 63 Hz	Max output frequency 500 Hz	Input frequency variation 47 to 63 Hz										
Ambient Operating Temperatures*	-20 °C to 50 °C (-4 °F to 122 °F) -20 °C to 60 °C (-4 °F to 140 °F) with current derating -20 °C to 70 °C (-4 °F to 158 °F) with current derating (with optional control module fan kit)		-20 °C to 50 °C (-4 °F to 122 °F) -20 °C to 60 °C (-4 °F to 140 °F) with current derating -20 °C to 70 °C (-4 °F to 158 °F) with current derating (with optional control module fan kit)											
Altitude	1000 m (3,280 ft) with derating guideline for up to max 4000 m (13,123 ft), with the exception of 600V at max 2000 m (6,561 ft)		1000 m (3,280 ft) with derating guideline for up to max 4000 m (13,123 ft), with the exception of 600V at max 2000 m (6,561ft)											
Enclosures	IP20 NEMA/Open	IP30 NEMA/UL Type 1 (with conduit kit)	IP20 NEMA/Open	IP30 NEMA/UL Type 1 (with conduit kit)										
Mounting	DIN rail (frames A,B and C) Zero Stacking	50 mm (1.96 in) air-flow gap at the top and bottom	DIN rail (frames A,B and C) Zero Stacking	50mm (1.96 in) air-flow gap at the top and bottom***										
Configuration	Integral HIM, LCD, 5 digits, 16 segments, multi-language Connected Components Workbench software Studio 5000™ Logix Designer application		Integral HIM, LCD, 5 digits, 16 segments, multi-language Connected Components Workbench software Studio 5000™ Logix Designer application											
Human Interface Module (HIM) Languages	English, French, Spanish, Italian, German, Portuguese, Polish, Turkish, Czech		English, French, Spanish, Italian, German, Portuguese, Polish, Turkish, Czech											
Control I/O	5 digital inputs (24V DC, 4 programmable) 1 analog input (unipolar voltage or current) 1 relay (form C)		7 digital inputs (24V DC, 6 programmable) 2 analog inputs (1 bipolar voltage, 1 current) 2 digital outputs 1 analog output (1 unipolar voltage or current) 2 relays (1 form A relay & 1 form B relay; 24V DC, 120V AC, 240V AC)											
Dynamic Braking	7th IGBT braking, DC braking		7th IGBT braking, DC braking											
Carrier Frequency	2 to 16 kHz. 4 kHz default		2 to 16 kHz. 4 kHz default											
EMC Filtering	Embedded 1 ph 240V and 3 ph 480V. Available as an external option for all voltages		Embedded 1 ph 240V and 3 ph 480V. Available as an external option for all voltages											
Safety	None		Embedded ISO 13849-1 SIL2/PLD Cat 3 Safe Torque-Off											
Communications	Integral RS485 with Modbus RTU/DSI Dual port EtherNet/IP option card DeviceNet option card PROFIBUS® DP option card		Integral RS485 with Modbus RTU/DSI Embedded EtherNet/IP port Dual port EtherNet/IP option card DeviceNet option card PROFIBUS DP option card											
Feedback Types	None		Line driver type encoder quadrature (dual channel) or single channel -Single ended or differential (A, B channel); Duty cycle of 50%, +10% Pulse-train input (1 to 100kHz) -Configurable input voltage: 5VDC (±10%); 10-12VDC (±10%), or 24V DC (±15%) Allowance pulse frequency -DC to 250 kHz Frequency controlled PWM allowable pulse frequency											
Protection	Fault history log, password-lock security		Fault history log, password-lock security											
Standards	UL	C-Tick	RoHS	ACS 156	CE	cUL	GOST-R	KCC	UL	TUV	C-Tick	Semi F47	ATEX	CE Marine (Lloyds)
Control Features	Flying start V/F ratio Bus regulator Process PID Common DC bus Fiber application specific features	PTC input compatible 1/2 DC bus operation 8 datalinks (4 in and 4 out, requires communication option card) Multi-drive connectivity (requires communication option card) 8 preset speeds	Flying start V/F ratio Bus regulator Process PID Common DC bus StepLogic™ functions (relays and timers) Fiber application specific features PTC input compatible	Position control Regulation with encoder feedback or analog input 1/2 DC bus operation 8 datalinks (4 in and 4 out) Multi-drive connectivity 16 preset speeds										
Accessories	70 °C (158 °F) control module fan kit (requires external power) EMC plates NEMA/UL Type 1 kits	EMC line filters Line reactors Dynamic brake resistors	70 °C (158 °F) control module fan kit (may require external power) Incremental encoder EMC plates NEMA/UL Type 1 kits	EMC line filters Line reactors Dynamic brake resistors										
Dimensions mm (in)	Frame A: 152 (5.98) H x 72 (2.83) W x 172 (6.77) D Frame B: 180 (7.08) H x 87 (3.42) W x 172 (6.77) D Frame C: 220 (8.66) H x 109 (4.29) W x 184 (7.24) D Frame D: 260 (10.23) H x 130 (5.11) W x 212 (8.34) D		Frame A: 152 (5.98) H x 72 (2.83) W x 172 (6.77) D Frame B: 180 (7.08) H x 87 (3.42) W x 172 (6.77) D Frame C: 220 (8.66) H x 109 (4.29) W x 184 (7.24) D Frame D: 260 (10.23) H x 130 (5.11) W x 212 (8.34) D Frame E: 300 (11.81) H x 185 (7.28) W x 279 (10.98) D											

* Permanent magnet motor control is scheduled for a future firmware release

** These temperatures are for typical vertical drive mounting. For other mounting options and temperatures, please refer to the user manual (520-UM001)

*** Frame E at 60°C to 70°C requires 95mm (3.74 in) airflow gap at the top of the drive and a control module fan kit

PowerFlex 523 AC Drives

50/60Hz	Heavy Duty (HD)		Output Current	Catalog No.	Frame Size
	Hp	kW			
100-120V, 1Ø No Filter	0.25	0.2	1.6A	25A-V1P6N104	A
	0.5	0.4	2.5A	25A-V2P5N104	A
	1	0.75	4.8A	25A-V4P8N104	B
	1.5	1.1	6.0A	25A-V6P0N104	B
200-240V, 1Ø No Filter	0.25	0.2	1.6A	25A-A1P6N104	A
	0.5	0.4	2.5A	25A-A2P5N104	A
	1	0.75	4.8A	25A-A4P8N104	A
	2	1.5	8.0A	25A-A8P0N104	B
	3	2.2	11.0A	25A-A011N104	B
200-240V, 1Ø EMC Filter	0.25	0.2	1.6A	25A-A1P6N114	A
	0.5	0.4	2.5A	25A-A2P5N114	A
	1	0.75	4.8A	25A-A4P8N114	A
	2	1.5	8.0A	25A-A8P0N114	B
	3	2.2	11.0A	25A-A011N114	B
200-240V, 3Ø No Filter	0.25	0.2	1.6A	25A-B1P6N104	A
	0.5	0.4	2.5A	25A-B2P5N104	A
	1	0.75	5.0A	25A-B5P0N104	A
	2	1.5	8.0A	25A-B8P0N104	A
	3	2.2	11.0A	25A-B011N104	A
	5	4	17.5A	25A-B017N104	B
	7.5	5.5	24.0A	25A-B024N104	C
	10	7.5	32.2A	25A-B032N104	D
380-480V, 3Ø No Filter	0.5	0.4	1.4A	25A-D1P4N104	A
	1	0.75	2.3A	25A-D2P3N104	A
	2	1.5	4.0A	25A-D4P0N104	A
	3	2.2	6.0A	25A-D6P0N104	A
	5	4	10.5A	25A-D010N104	B
	7.5	5.5	13.0A	25A-D013N104	C
	10	7.5	17.0A	25A-D017N104	C
	15	11	24A	25A-D024N104	D
380-480V, 3Ø EMC Filter	0.5	0.4	1.4A	25A-D1P4N114	A
	1	0.75	2.3A	25A-D2P3N114	A
	2	1.5	4.0A	25A-D4P0N114	A
	3	2.2	6.0A	25A-D6P0N114	A
	5	4	10.5A	25A-D010N114	B
	7.5	5.5	13.0A	25A-D013N114	C
	10	7.5	17.0A	25A-D017N114	C
	15	11	24A	25A-D024N114	D
525-600V, 3Ø No Filter	0.5	0.4	0.9A	25A-E0P9N104	A
	1	0.75	1.7A	25A-E1P7N104	A
	2	1.5	3.0A	25A-E3P0N104	A
	3	2.2	4.2A	25A-E4P2N104	A
	5	4	6.6A	25A-E6P6N104	B
	7.5	5.5	9.9A	25A-E9P9N104	C
	10	7.5	12.0A	25A-E012N104	C
	15	11	19.0A	25A-E019N104	D

PowerFlex 525 AC Drives

50/60Hz	Normal Duty (ND)		Heavy Duty (HD)		Output Current	Catalog No.	Frame Size
	Hp	kW	Hp	kW			
100-120V, 1Ø No Filter	0.5	0.4	0.5	0.4	2.5A	25B-V2P5N104	A
	1	0.75	1	0.75	4.8A	25B-V4P8N104	B
	1.5	1.1	1.5	1.1	6.0A	25B-V6P0N104	B
200-240V, 1Ø No Filter	0.5	0.4	0.5	0.4	2.5A	25B-A2P5N104	A
	1	0.75	1	0.75	4.8A	25B-A4P8N104	A
	2	1.5	2	1.5	8.0A	25B-A8P0N104	B
	3	2.2	3	2.2	11.0A	25B-A011N104	B
200-240V, 1Ø EMC Filter	0.5	0.4	0.5	0.4	2.5A	25B-A2P5N114	A
	1	0.75	1	0.75	4.8A	25B-A4P8N114	A
	2	1.5	2	1.5	8.0A	25B-A8P0N114	B
	3	2.2	3	2.2	11.0A	25B-A011N114	B
200-240V, 3Ø No Filter	0.5	0.4	0.5	0.4	2.5A	25B-B2P5N104	A
	1	0.75	1	0.75	5.0A	25B-B5P0N104	A
	2	1.5	2	1.5	8.0A	25B-B8P0N104	A
	3	2.2	3	2.2	11.0A	25B-B011N104	A
	5	4	5	4	17.5A	25B-B017N104	B
	7.5	5.5	7.5	5.5	24.0A	25B-B024N104	C
	10	7.5	10	7.5	32.2A	25B-B032N104	D
	15	11	15	11	48.3A	25B-B048N104	E
380-480V, 3Ø No Filter	0.5	0.4	0.5	0.4	1.4A	25B-D1P4N104	A
	1	0.75	1	0.75	2.3A	25B-D2P3N104	A
	2	1.5	2	1.5	4.0A	25B-D4P0N104	A
	3	2.2	3	2.2	6.0A	25B-D6P0N104	A
	5	4	5	4	10.5A	25B-D010N104	B
	7.5	5.5	7.5	5.5	13.0A	25B-D013N104	C
	10	7.5	10	7.5	17.0A	25B-D017N104	C
	15	11	15	11	24A	25B-D024N104	D
	20	15	15	11	30A	25B-D030N104	D
	25	18.5	20	15	37A	25B-D037N114*	E
380-480V, 3Ø EMC Filter	0.5	0.4	0.5	0.4	1.4A	25B-D1P4N114	A
	1	0.75	1	0.75	2.3A	25B-D2P3N114	A
	2	1.5	2	1.5	4.0A	25B-D4P0N114	A
	3	2.2	3	2.2	6.0A	25B-D6P0N114	A
	5	4	5	4	10.5A	25B-D010N114	B
	7.5	5.5	7.5	5.5	13.0A	25B-D013N114	C
	10	7.5	10	7.5	17.0A	25B-D017N114	C
	15	11	15	11	24A	25B-D024N114	D
	20	15	15	11	30A	25B-D030N114	D
	25	18.5	20	15	37A	25B-D037N114	E
525- 600V, 3Ø No Filter	0.5	0.4	0.5	0.4	0.9A	25B-E0P9N104	A
	1	0.75	1	0.75	1.7A	25B-E1P7N104	A
	2	1.5	2	1.5	3.0A	25B-E3P0N104	A
	3	2.2	3	2.2	4.2A	25B-E4P2N104	A
	5	4	5	4	6.6A	25B-E6P6N104	B
	7.5	5.5	7.5	5.5	9.9A	25B-E9P9N104	C
	10	7.5	10	7.5	12.0A	25B-E012N104	C
	15	11	15	11	19.0A	25B-E019N104	D
	20	15	15	11	22.0A	25B-E022N104	D
	25	18.5	20	15	27.0A	25B-E027N104	E
30	22	25	18.5	32.0A	25B-E032N104	E	

*With EMC filter



Energy Savings Calculators

See how installing a PowerFlex drive for your fan or pump can help reduce energy costs when compared with traditional flow control methods. Download the tools at:

<http://www.rockwellenergycalc.com/>



Download or order a copy of Connected Components Workbench software at www.ab.com/go/ccws



Rockwell Automation, Inc. (NYSE:ROK), the world's largest company dedicated to industrial automation, makes its customers more productive and the world more sustainable. Throughout the world, our flagship Allen-Bradley® and Rockwell Software® product brands are recognized for innovation and excellence.

Follow ROKAutomation on Facebook & Twitter.



Connect with us on LinkedIn.



Allen-Bradley, AppView, ArmorBlock, Connected Components Workbench, CustomView, Integrated Architecture, LISTEN. THINK. SOLVE, MainsFree, Micro800, PanelView, PointStop, PowerFlex, QuickView, RSLogix 5000, Rockwell Software and Stratix, Studio 5000, Studio 5000 Logix Designer are trademarks of Rockwell Automation, Inc. Trademarks not belonging to Rockwell Automation are property of their respective companies.

www.rockwellautomation.com

Power, Control and Information Solutions Headquarters

Americas: Rockwell Automation, 1201 South Second Street, Milwaukee, WI 53204-2496 USA, Tel: (1) 414.382.2000, Fax: (1) 414.382.4444

Europe/Middle East/Africa: Rockwell Automation NV, Pegasus Park, De Kleetlaan 12a, 1831 Diegem, Belgium, Tel: (32) 2 663 0600, Fax: (32) 2 663 0640

Asia Pacific: Rockwell Automation, Level 14, Core F, Cyberport 3, 100 Cyberport Road, Hong Kong, Tel: (852) 2887 4788, Fax: (852) 2508 1846