

Piezo Switch for Explosive Environments



PSE M19 EX



Description

- Piezo switch certified according to ATEX and IECEx
- Assembly by mounting with nut
- Pins, Crimp Terminal male, AMP

Approvals

- EMC: EMC directive 2004/108/EWG
- ATEX Approval Test Report:
 - SEV 13 ATEX 0170
 - IECEX SEV 13.0011
- ATEX Approval Marking:
 - Ex II 2 GD
 - Ex ib IIC T6...T5 Gb
 - Ex ib IIIC T85°C...T100°C Db
- MIL-STD Certificate Number: 202F Method 107G, 202F Method 204D, 202F Method 213B, 416D Method RS103, 810E Method 501.3, 810E Method 502.3, 810E Method 507.3
- VDE Certificate Number: DIN EN 61000-4-2, DIN EN 61000-4-4

Characteristics

- Housing material types: aluminum, brass chrome-plated or stainless steel
- High reliability, long lifetime with more than 20 mill. actuations
- Easy to clean due to a tightly closed surface (IP 69K)
- for use in harsh environments, in potentially explosive applications and environments where volatile fumes, gases and dust are present

References

Alternative: Standard version [PSE NO 19](#)

Weblinks

[html-datasheet](#), [General Product Information](#), [CE declaration of conformity](#), [RoHS](#), [CHINA-RoHS](#), [e-Shop](#), [CAD-Drawings](#), [Product News](#), [Detailed request for product](#)

Technical Data

Electrical Data

Switching Function	N.O.
Switching Voltage	Ui max. 24 / 24 VAC/DC
Switching Current	Ii max. 40 mA
Rated Breaking Capacity (Temperature Class T5/T100°C)	Pi max. 0.96 W
Rated Breaking Capacity (Temperature Class T6/T85°C)	Pi max. 0.7 W
Lifetime	20 million at Rated Switching Capacity
Switch Resistance OFF	> 10 kΩ
Switch Resistance ON	< 20 mΩ
Capacity	5 pF
N.O. Closing Impulse Duration	20- 1000 ms
Contact Configuration	free polarity

Mechanical Data

Actuating Force	≤ 3 N at ambient temperature
Actuating Travel	0.002 mm
Shock Protection	IK 02
Tightening Torque	2.5 Nm

Climatical Data

Operating Temperature	-20 to +60 °C
Storage Temperature	-20 to +60 °C
IP-Protection	IP 67 Front Side submerged (1m water column), IP 69K Front side High Pressure cleaner test, Front Side / Rear Side DIN EN 60068-2-30 Db (Moist heat - air test with 55°C / 93% humidity)
Salt Spray Test (acc. to DIN 50021-SS)	24 h / 48 h / 96 h Residence Time

Material

Housing (depending on type)	Stainless Steel, Aluminium anodized, Polyamide, Chromed Brass
-----------------------------	---

Dimension

PSE M19 with Pins

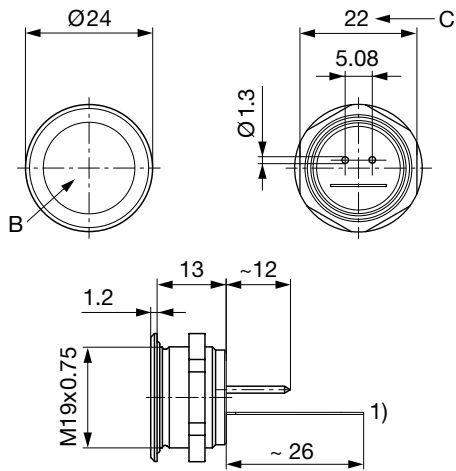

Legend:

1) = Type label

B = Actuating area

C = Width across flats

l = Crimp terminal male 3.6 x 0.8

- Wire (Standard: 0.14 mm² / 200 mm wire-length)

- Pins (with connection terminal 0701.9225)

- AMP

Lettering:

- Either with/without lettering

- Position of the connections with respect to the position of the lettering is not defined

Dimension

PSE M19

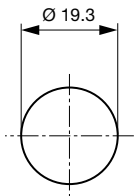

Drilling diagram

Lettering

The last three digits in the order number define the lettering:

001-076 Standard Lettering

101- Customized Lettering

Lettering - Aluminium / Plastic Material

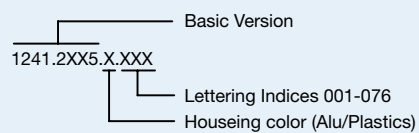

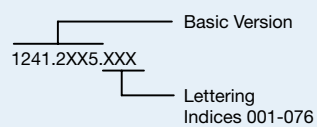

Lettering - Stainless Steel



Lettering Colour of Laser Lettering

Material	Lettering Colour	
Stainless Steel	black	Filled letters
Aluminum natural anodized	light grey	Filled letters (only after customer approval)
Aluminum coloured anodized	light grey	Filled letters

Order Index Lettering

Laser Marking			
001 = A	021 = U	041 = ÷	061 = EIN
002 = B	022 = V	042 = *	062 = AUS
003 = C	023 = W	043 = =	063 = AUF
004 = D	024 = X	044 = #	064 = AB
005 = E	025 = Y	045 = ↔	065 = ON
006 = F	026 = Z	046 = †	066 = OFF
007 = G	027 = 0	047 = →	067 = UP
008 = H	028 = 1	048 = ←	068 = DOWN
009 = I	029 = 2	049 = ↓	069 = HIGH
010 = J	030 = 3	050 = ↑	070 = LOW
011 = K	031 = 4	051 = %	071 = ON/OFF
012 = L	032 = 5	052 = √	072 = START
013 = M	033 = 6	053 = CTRL	073 = RESET
014 = N	034 = 7	054 = RETURN	074 = 
015 = O	035 = 8	055 = SHIFT	075 = 
016 = P	036 = 9	056 = LOCK	076 = 
017 = Q	037 = +	057 = STOP	
018 = R	038 = -	058 = ENTER	
019 = S	039 = .	059 = BACK	
020 = T	040 = x	060 = LINE	

All Variants

Mounting Diameter [mm]	Terminal	Housing Material	Colour of Housing	Config. Code	Order Number
19	Pins	Aluminum	red	PSE M 19 EX	1241.2475.3
19	Pins	Aluminum	green	PSE M 19 EX	1241.2475.5
19	Pins	Aluminum	Alu natural	PSE M 19 EX	1241.2475.8

Annotation to the protection type:

- The explosion protected piezo switch element (PSE EX) has the function of a NO (normally open) switch.
- Permissible voltage and current of the PSE EX are limited, so that the PSE EX is intrinsically safe in accordance with EN60079-11 (see Technical Data).
- The use of the PSE EX is permitted in areas where the formation of explosive atmospheres caused by gases, fumes, mist or dust mixing with air occurs occasionally. The explosion protected PSE is classified according to EN 60079-0 in the device group II, category 2.

Attention:

- The permissible operating temperature is - 20°C to 60°C.
- The approval will cease when the type label is removed.
- The switch has to be installed and used according to IEC/EN 60079-14 and IEC/EN 60079-25.

The listed item numbers represent a selection of the range of piezo switches.

Other mounting diameters, materials, colors, connections and symbols are available on request.

Special materials for use in salt and chlorinated environment on request.

Availability for all products can be searched real-time: <http://www.schurter.com/en/Stock-Check/Stock-Check-SCHURTER>

Packaging unit 10 in cardboard box packed in air cushion bag with instruction manual



- Actuating elements in ESD safe packaging
- Screw nuts and sealing rings in a bag (enclosed in the box)

Accessories

Description



Connecting Terminal PSE
Connecting Terminal