

For the electronic measurement of current: DC, AC, pulsed..., with galvanic separation between the primary and the secondary circuit.

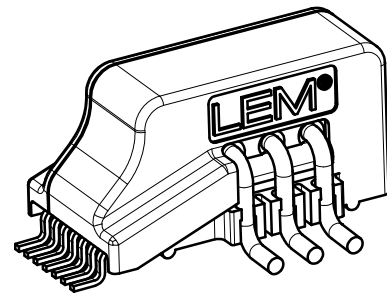

Features

- Hall effect measuring principle
- Multirange current transducer through PCB pattern lay-out
- Galvanic separation between primary and secondary circuit
- Insulated test voltage 4300 V
- Low power consumption
- Extremely low profile 12 mm
- Fixed offset & sensitivity
- Over-current detect $2.63 \times I_{PN}$ (peak value)
- Memory check.

Special feature

- Single power supply 3.3 V.

Advantages

- Small size and space saving
- Only one design for wide primary current range
- High immunity to external interference
- 8 mm creepage /clearance
- Fast response.

Applications

- AC variable speed drives
- Static converters for DC motor drives
- Battery supplied applications
- Uninterruptible Power Supplies (UPS)
- Switched Mode Power Supplies (SMPS)
- Power supplies for welding applications
- The solar inverter on DC side of the inverter (MPPT)
- Combiner box.

Standards

- EN 50178: 1997
- IEC 61010-1: 2010
- IEC 61326-1: 2012
- UL 508: 2010.

Application Domain

- Industrial.

Absolute maximum ratings

Parameter	Symbol	Unit	Value
Supply voltage (not operating)	U_C	V	6.5
Primary conductor temperature	T_B	°C	120
ESD rating, Human Body Model (HBM)	U_{ESD}	kV	2

Stresses above these ratings may cause permanent damage. Exposure to absolute maximum ratings for extended periods may degrade reliability.

UL 508: Ratings and assumptions of certification

File # E189713 Volume: 2 Section: 5

Standards

- CSA C22.2 NO. 14-10 INDUSTRIAL CONTROL EQUIPMENT - Edition 11 - Revision Date 2011/08/01
- UL 508 STANDARD FOR INDUSTRIAL CONTROL EQUIPMENT - Edition 17 - Revision Date 2010/04/15

Ratings

Parameter	Symbol	Unit	Value
Primary involved potential		V AC/DC	600
Max surrounding air temperature	T_A	°C	105
Primary current	I_P	A	According to series primary currents
Secondary supply voltage	U_C	V DC	3.3
Output voltage	V_{out}	V	0 to 3.3

Conditions of acceptability

When installed in the end-use equipment, consideration shall be given to the following:

- 1 - These devices have been evaluated for overvoltage category III and for use in pollution degree 2 environment.
- 2 - A suitable enclosure shall be provided in the end-use application.
- 3 - The terminals have not been evaluated for field wiring.
- 4 - These devices have been evaluated for use in 105 °C maximum surrounding air temperature.
- 5 - The secondary (Sensing) circuit is intended to be supplied by a Isolated Secondary Circuit - Limited voltage circuit defined by UL 508 paragraph 32.5. The maximum open circuit voltage potential available to the circuit and overcurrent protection shall be evaluated in the end use application.
- 6 - These devices are intended to be mounted on a printed wiring board of end-use equipment. The suitability of the connections (including spacings) shall be determined in the end-use application.
- 7 - Primary terminals shall not be straightened since assembly of housing case depends upon bending of the terminals.
- 8 - Any surface of polymeric housing have not been evaluated as insulating barrier.
- 9 - Low voltage circuits are intended to be powered by a circuit derived from an isolating source (such as a transformer, optical isolator, limiting impedance or electro-mechanical relay) and having no direct connection back to the primary circuit (other than through the grounding means).

Marking

Only those products bearing the UL or UR Mark should be considered to be Listed or Recognized and covered under UL's Follow-Up Service. Always look for the Mark on the product.

Insulation coordination

Parameter	Symbol	Unit	Value	Comment
Rms voltage for AC isolation test 50/60 Hz/1 min	U_d	kV	4.3	
Impulse withstand voltage 1.2/50 μ s	\dot{U}_w	kV	8	
Partial discharge extinction rms voltage @ 10 pC	U_e	V	1650	
Clearance (pri. - sec.)	d_{Cl}	mm	8	Shortest distance through air
Creepage distance (pri. - sec.)	d_{cp}	mm	8	Shortest path along device body
Case material			V0 according to UL 94	
Comparative tracking index	CTI		600	
Application example	-	-	600 V CAT III PD2	Reinforced insulation, non uniform field according to EN 50178
Application example	-	-	300 V CAT III PD2	Reinforced insulation, non uniform field according to IEC 61010
Application example	-	-	1000 V CAT III PD2	Simple insulation, non uniform field according to EN 50178, IEC 61010

Environmental and mechanical characteristics

Parameter	Symbol	Unit	Min	Typ	Max	Comment
Ambient operating temperature	T_A	$^{\circ}$ C	-40		105	
Ambient storage temperature	T_S	$^{\circ}$ C	-40		105	
Surrounding temperature according to UL 508		$^{\circ}$ C			105	
Mass	m	g		5		

Electrical data HO 8-NSM/SP33-1000

 At $T_A = 25^\circ\text{C}$, $U_C = +3.3\text{ V}$, $N_P = 3$ turns, $R_L = 10\text{ K}\Omega$ unless otherwise noted (see Min, Max, typ. definition paragraph in page 12).

Parameter	Symbol	Unit	Min	Typ	Max	Comment
Primary nominal rms current	I_{PN}	At		8		
Primary current, measuring range	I_{PM}	At	-20		20	
Number of primary turns	N_P			1,2,3		
Supply voltage	U_C	V	3.14	3.3	3.46	
Current consumption	I_C	mA			25	
Reference voltage	V_{ref}	V	1.636	1.65	1.664	Internal reference
External reference voltage	V_{ref}	V	0.5		1.85	@ $U_C = 3.3 \approx 3.46\text{ V}$
			0.5		1.7	@ $U_C = 3.14 \approx 3.3\text{ V}$
Output voltage range @ I_{PM}	$V_{out} - V_{ref}$	V	-1.15		1.15	
Output voltage @ $I_P = 0\text{ A}$	V_{out}	V		$V_{ref} + V_{OE}$		
Electrical offset voltage	V_{OE}	mV	-7		7	
Temperature coefficient of V_{ref}	TCV_{ref}	ppm/K			± 170	-20 °C .. 85 °C Internal reference
					± 180	-40 °C .. 105 °C Internal reference
Temperature coefficient of V_{OE}	TCV_{OE}	mV/K			± 0.080	-40 °C .. 105 °C
Theoretical sensitivity	G_{th}	mV/A		57.5		460 mV/ I_{PN} @ $U_C = 3.3\text{ V}$
Sensitivity error	ϵ_G	%			± 0.5	Factory adjustment
Temperature coefficient of G	TCG	ppm/K			± 200	-20 °C .. 85 °C
					± 210	-40 °C .. 105 °C
Linearity error 0 .. I_{PN}	ϵ_L	% of I_{PN}			± 0.5	@ $U_C = 3.3\text{ V}$
Linearity error 0 .. I_{PM}	ϵ_L	% of I_{PM}			± 0.8	@ $U_C = 3.3\text{ V}$
Gain error with respect to $U_C \pm 10\%$		%/%			± 0.4	Gain error per U_C drift
Magnetic offset voltage @ $I_P = 0$ after $2.5 \times I_{PN}$	V_{OM}	mV			± 4	
Reaction time @ 10 % of I_{PN}	t_{ra}	μs			2	$di/dt = I_{PN}/\mu\text{s}$
Response time @ 90 % of I_{PN}	t_r	μs			3.5	$di/dt = I_{PN}/\mu\text{s}$
Frequency bandwidth (-3 dB)	BW	kHz		250		
Output rms voltage noise (spectral density) (DC .. 100 kHz)	e_{no}	$\mu\text{V}/\sqrt{\text{Hz}}$			18.9	
Output voltage noise (DC .. 20 MHz)	V_{no}	mVpp		40		
Standby pin "0" level		V			0.3	
Standby pin "1" level		V	$U_C - 0.3$			
Time to switch from standby to normal mode		μs			20	
Over-current detect		At	$2.6 \times I_{PN}$	$2.9 \times I_{PN}$	$3.2 \times I_{PN}$	peak value
Accuracy @ I_{PN}	X	% of I_{PN}			± 1	$= \epsilon_G + \epsilon_L$
Accuracy @ I_{PN} @ $T_A = +85^\circ\text{C}$	X	% of I_{PN}			± 3.3	See formula note ¹⁾
Accuracy @ I_{PN} @ $T_A = +105^\circ\text{C}$	X	% of I_{PN}			± 4.1	See formula note ¹⁾

Note: ¹⁾ Accuracy @ I_P and $X_{TA} = \pm [X + (TCG/10000) \cdot (T_A - 25) + TCV_{OE} \cdot 100 \cdot (T_A - 25) / (G_{th} \cdot I_P)]$.

Electrical data HO 15-NSM/SP33-1000

 At $T_A = 25^\circ\text{C}$, $U_C = +3.3\text{V}$, $N_P = 3$ turns, $R_L = 10\text{K}\Omega$ unless otherwise noted (see Min, Max, typ. definition paragraph in page 12).

Parameter	Symbol	Unit	Min	Typ	Max	Comment
Primary nominal rms current	I_{PN}	At		15		
Primary current, measuring range	I_{PM}	At	-37.5		37.5	
Number of primary turns	N_P			1,2,3		
Supply voltage	U_C	V	3.14	3.3	3.46	
Current consumption	I_C	mA			25	
Reference voltage	V_{ref}	V	1.636	1.65	1.664	Internal reference
External reference voltage	V_{ref}	V	0.5		1.85	@ $U_C = 3.3 \approx 3.46\text{V}$
			0.5		1.7	@ $U_C = 3.14 \approx 3.3\text{V}$
Output voltage range @ I_{PM}	$V_{out} - V_{ref}$	V	-1.15		1.15	
Output voltage @ $I_P = 0\text{A}$	V_{out}	V		$V_{ref} + V_{OE}$		
Electrical offset voltage	V_{OE}	mV	-5		5	
Temperature coefficient of V_{ref}	TCV_{ref}	ppm/K			± 170	-20 °C .. 85 °C Internal reference
					± 180	-40 °C .. 105 °C Internal reference
Temperature coefficient of V_{OE}	TCV_{OE}	mV/K			± 0.080	-40 °C .. 105 °C
Theoretical sensitivity	G_{th}	mV/A		30.67		460 mV/ I_{PN} , @ $U_C = 3.3\text{V}$
Sensitivity error	ϵ_G	%			± 0.5	Factory adjustment
Temperature coefficient of G	TCG	ppm/K			± 200	-20 °C .. 85 °C
					± 210	-40 °C .. 105 °C
Linearity error 0 .. I_{PN}	ϵ_L	% of I_{PN}			± 0.5	@ $U_C = 3.3\text{V}$
Linearity error 0 .. I_{PM}	ϵ_L	% of I_{PM}			± 0.8	@ $U_C = 3.3\text{V}$
Gain error with respect to $U_C \pm 10\%$		%/%			± 0.4	Gain error per U_C drift
Magnetic offset voltage @ $I_P = 0$ after $2.5 \times I_{PN}$	V_{OM}	mV			± 4	
Reaction time @ 10 % of I_{PN}	t_{ra}	μs			2	$di/dt = I_{PN}/\mu\text{s}$
Response time @ 90 % of I_{PN}	t_r	μs			3.5	$di/dt = I_{PN}/\mu\text{s}$
Frequency bandwidth (-3 dB)	BW	kHz		250		
Output rms voltage noise (spectral density) (DC .. 100 MHz)	e_{no}	$\mu\text{V}/\sqrt{\text{Hz}}$			10.15	
Output voltage noise (DC .. 20 MHz)	V_{no}	mVpp		30		
Standby pin "0" level		V			0.3	
Standby pin "1" level		V	$U_C - 0.3$			
Time to switch from standby to normal mode		μs			20	
Over-current detect		At	$2.6 \times I_{PN}$	$2.9 \times I_{PN}$	$3.2 \times I_{PN}$	peak value
Accuracy @ I_{PN}	X	% of I_{PN}			± 1	$= \epsilon_G + \epsilon_L$
Accuracy @ I_{PN} @ $T_A = +85^\circ\text{C}$	X	% of I_{PN}			± 3.3	See formula note ¹⁾
Accuracy @ I_{PN} @ $T_A = +105^\circ\text{C}$	X	% of I_{PN}			± 4.1	See formula note ¹⁾

Note: ¹⁾ Accuracy @ I_P and $X_{TA} = \pm [X + (TCG/10000) \cdot (T_A - 25) + TCV_{OE} \cdot 100 \cdot (T_A - 25) / (G_{th} \cdot I_P)]$.

Electrical data HO 25-NSM/SP33-1000

 At $T_A = 25^\circ\text{C}$, $U_C = +3.3\text{ V}$, $N_P = 3$ turns, $R_L = 10\text{ k}\Omega$ unless otherwise noted (see Min, Max, typ. definition paragraph in page 12).

Parameter	Symbol	Unit	Min	Typ	Max	Comment
Primary nominal rms current	I_{PN}	At		25		
Primary current, measuring range	I_{PM}	At	-62.5		62.5	
Number of primary turns	N_P			1,2,3		
Supply voltage	U_C	V	3.14	3.3	3.46	
Current consumption	I_C	mA			25	
Reference voltage	V_{ref}	V	1.636	1.65	1.664	Internal reference
External reference voltage	V_{ref}	V	0.5		1.85	@ $U_C = 3.3 \approx 3.46\text{ V}$
			0.5		1.7	@ $U_C = 3.14 \approx 3.3\text{ V}$
Output voltage range @ I_{PM}	$V_{out} - V_{ref}$	V	-1.15		1.15	
Output voltage @ $I_P = 0\text{ A}$	V_{out}	V		$V_{ref} + V_{OE}$		
Electrical offset voltage	V_{OE}	mV	-6		6	
Temperature coefficient of V_{ref}	TCV_{ref}	ppm/K			± 170	-20 °C .. 85 °C Internal reference
					± 180	-40 °C .. 105 °C Internal reference
Temperature coefficient of V_{OE}	TCV_{OE}	mV/K			± 0.080	-40 °C .. 105 °C
Theoretical sensitivity	G_{th}	mV/A		18.4		460 mV/ I_{PN} @ $U_C = 3.3\text{ V}$
Sensitivity error	ϵ_G	%			± 0.5	Factory adjustment
Temperature coefficient of G	TCG	ppm/K			± 200	-20 °C .. 85 °C
					± 210	-40 °C .. 105 °C
Linearity error 0 .. I_{PN}	ϵ_L	% of I_{PN}			± 0.5	@ $U_C = 3.3\text{ V}$
Linearity error 0 .. I_{PM}	ϵ_L	% of I_{PM}			± 0.8	@ $U_C = 3.3\text{ V}$
Gain error with respect to $U_C \pm 10\%$		%/%			± 0.4	Gain error per U_C drift
Magnetic offset voltage @ $I_P = 0$ after $2.5 \times I_{PN}$	V_{OM}	mV			± 4	
Reaction time @ 10 % of I_{PN}	t_{ra}	μs			2	$dI/dt = I_{PN}/\mu\text{s}$
Response time @ 90 % of I_{PN}	t_r	μs			3.5	$dI/dt = I_{PN}/\mu\text{s}$
Frequency bandwidth (-3 dB)	BW	kHz		250		
Output rms voltage noise (spectral density) (DC .. 100 MHz)	e_{no}	$\mu\text{V}/\sqrt{\text{Hz}}$			6.13	
Output voltage noise (DC .. 20 MHz)	V_{no}	mVpp		20		
Standby pin "0" level		V			0.3	
Standby pin "1" level		V	$U_C - 0.3$			
Time to switch from standby to normal mode		μs			20	
Over-current detect		At	$2.6 \times I_{PN}$	$2.9 \times I_{PN}$	$3.2 \times I_{PN}$	peak value
Accuracy @ I_{PN}	X	% of I_{PN}			± 1	$= \epsilon_G + \epsilon_L$
Accuracy @ I_{PN} @ $T_A = +85^\circ\text{C}$	X	% of I_{PN}			± 3.3	See formula note ¹⁾
Accuracy @ I_{PN} @ $T_A = +105^\circ\text{C}$	X	% of I_{PN}			± 4.1	See formula note ¹⁾

 Note: ¹⁾ Accuracy @ I_P and $X_{TA} = \pm [X + (TCG/10000) \cdot (T_A - 25) + TCV_{OE} \cdot 100 \cdot (T_A - 25) / (G_{th} \cdot I_P)]$.

Typical performance characteristics $I_{PN} = 8\text{ A}$

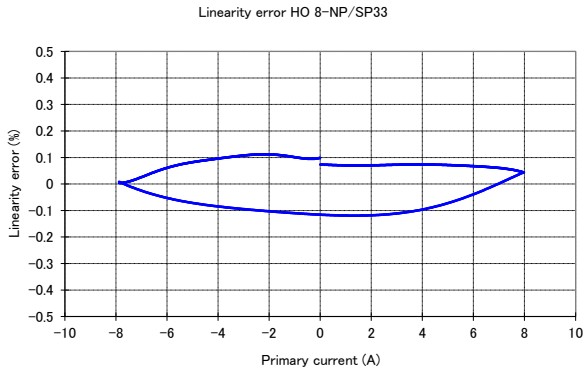

Figure 1: Linearity error

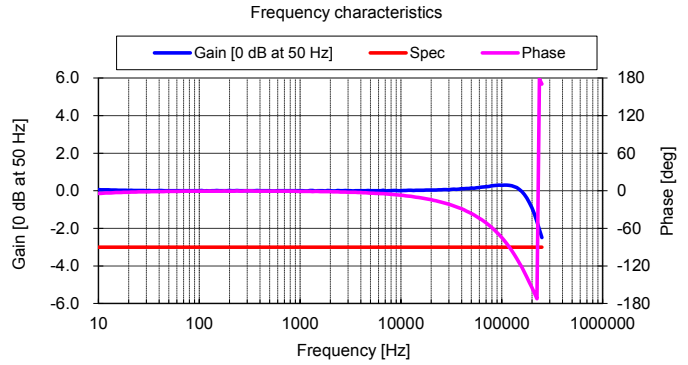

Figure 2: Frequency response

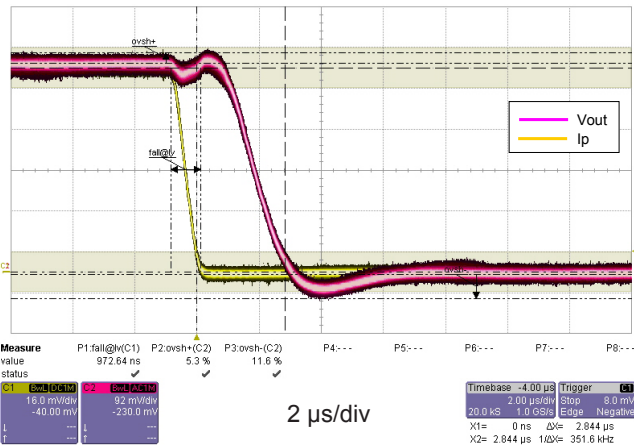

Figure 3: Step response

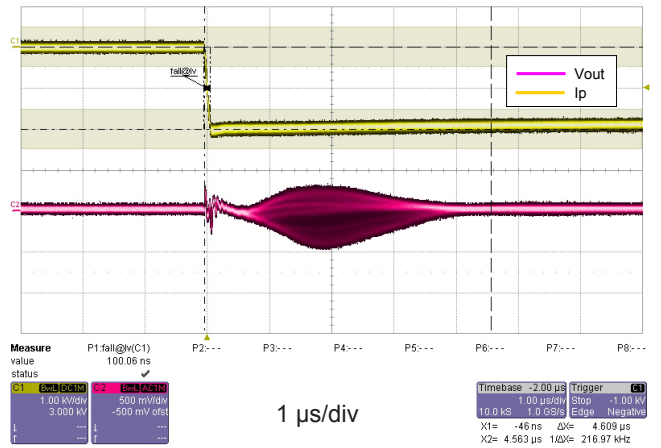

Figure 4: dv/dt

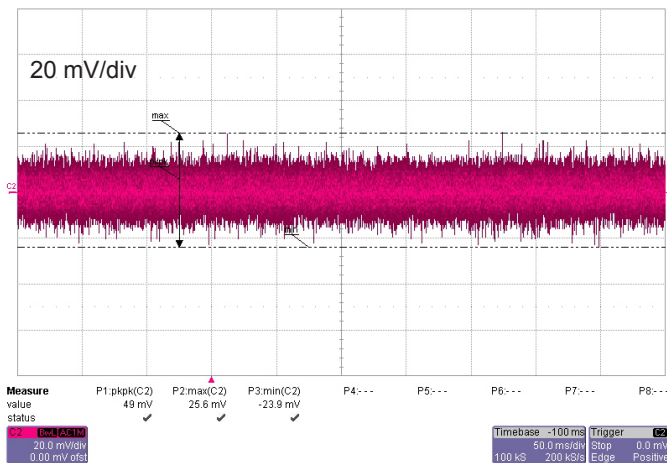

Figure 5: Output noise

Typical performance characteristics $I_{PN} = 15\text{ A}$

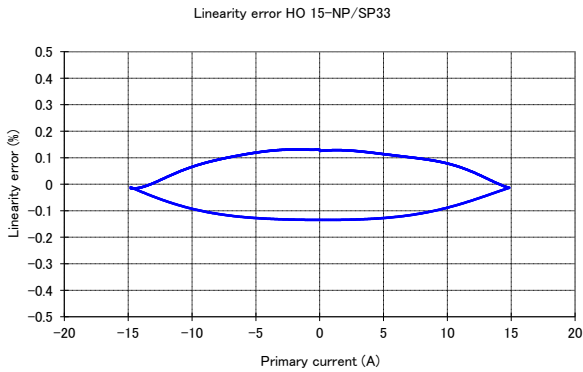

Figure 6: Linearity error

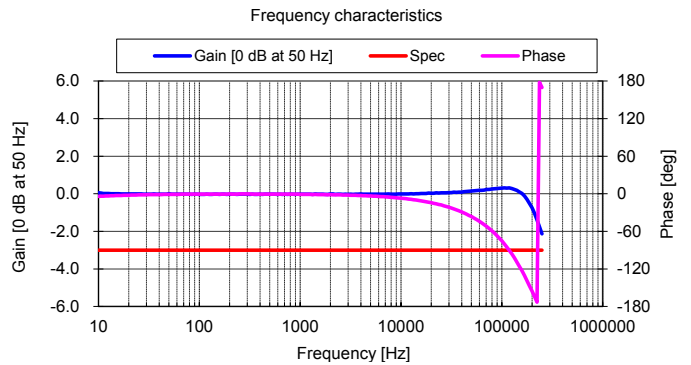

Figure 7: Frequency response

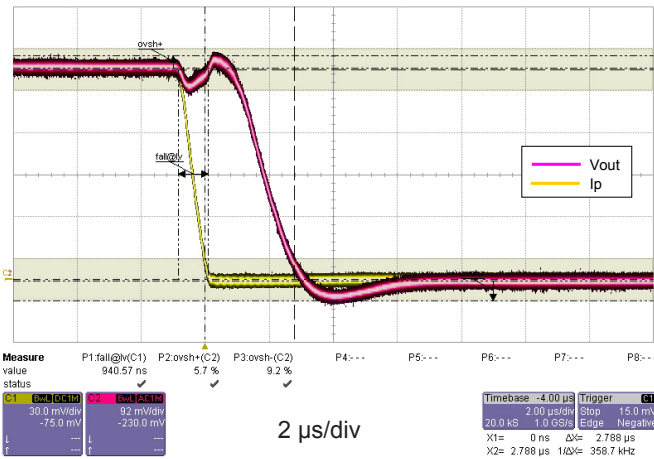

Figure 8: Step response

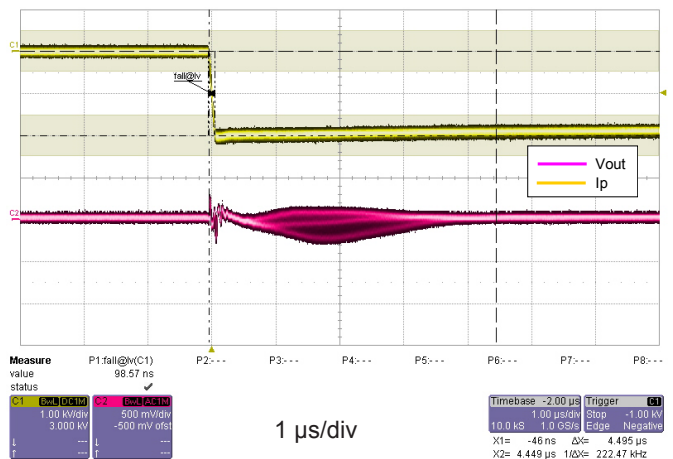

Figure 9: dv/dt

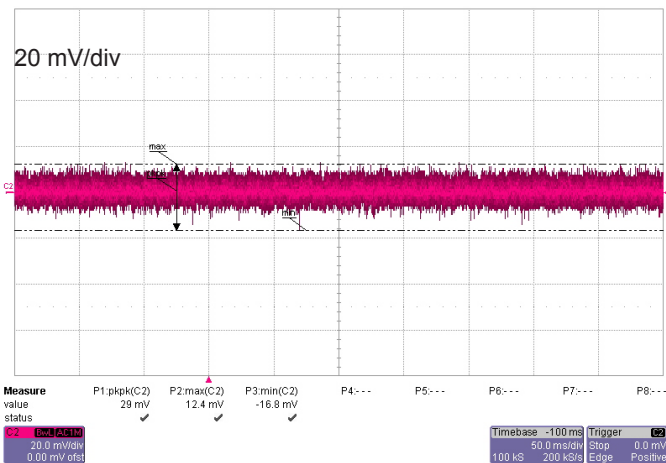

Figure 10: Output noise

Typical performance characteristics $I_{PN} = 25\text{ A}$

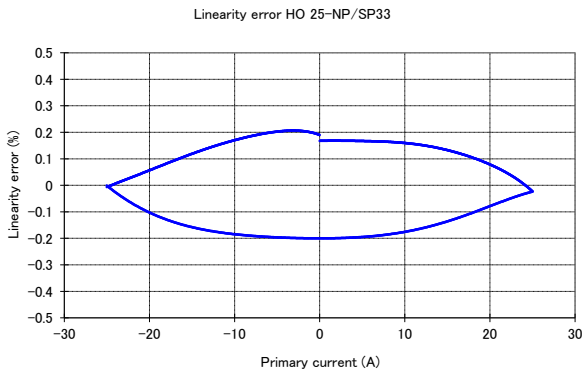

Figure 11: Linearity error

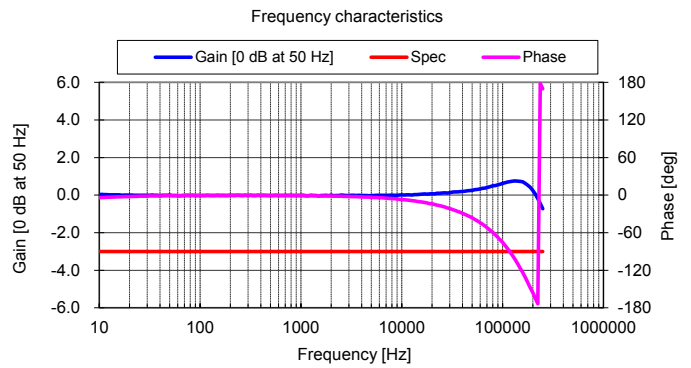

Figure 12: Frequency response

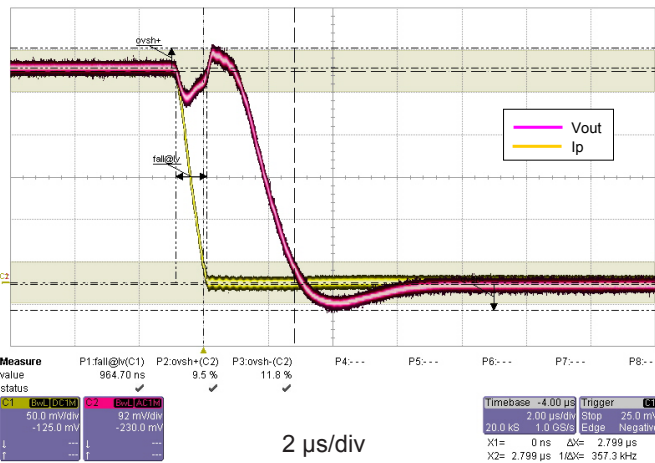

Figure 13: Step response

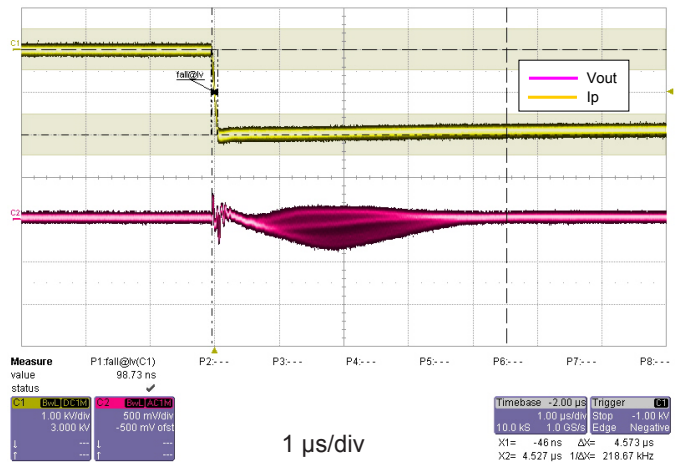

Figure 14: dv/dt

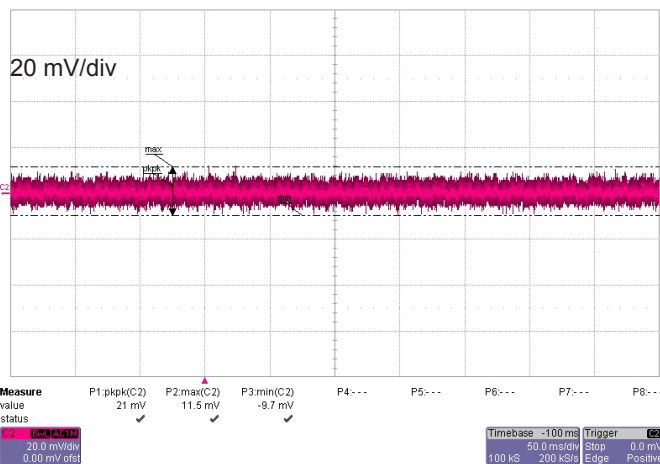

Figure 15: Output noise

Maximum continuous DC primary current

Figure 16: I_p vs T_A for HO series

Important notice: whatever the usage and/or application, the transducer jumper temperature shall not go above the maximum rating of 120 °C as stated in page 2 of this datasheet.

Measuring range with external reference voltage

Upper limit: $I_p = 17.39 \times V_{ref} + 48.7$ ($V_{ref} = 0.5 \dots 1.65$ V)

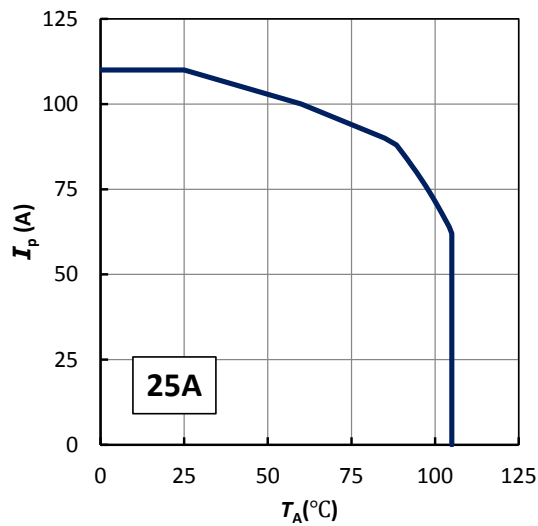
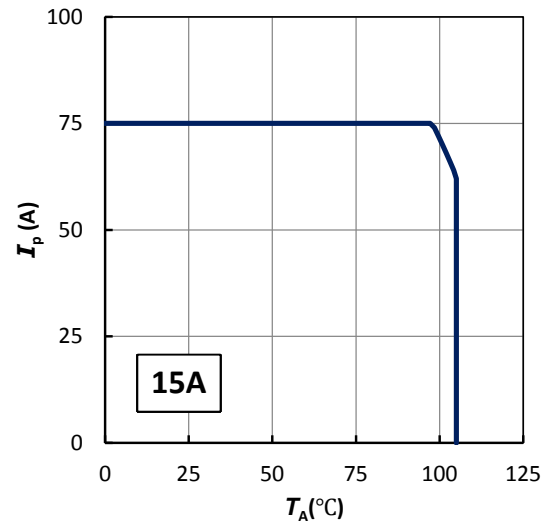
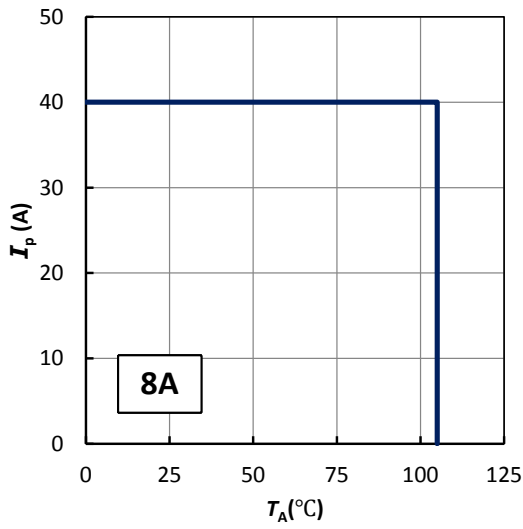
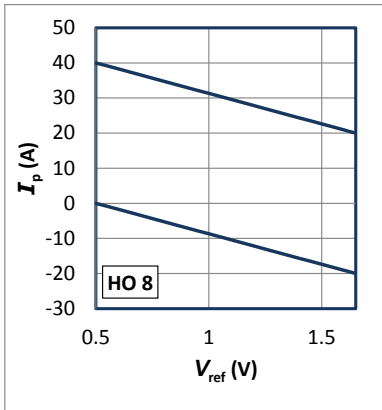
Lower limit: $I_p = 17.39 \times V_{ref} + 8.7$ ($V_{ref} = 0.5 \dots 1.65$ V)

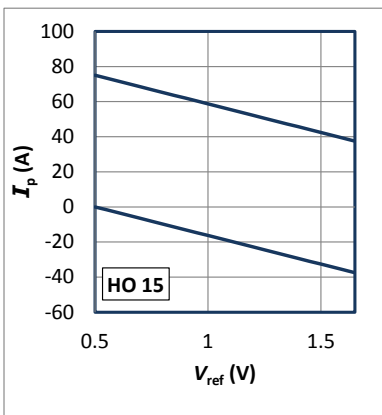

Upper limit: $I_p = -32.81 \times V_{ref} + 91.3$ ($V_{ref} = 0.5 \dots 1.65$ V)

Lower limit: $I_p = -32.81 \times V_{ref} + 16.3$ ($V_{ref} = 0.5 \dots 1.65$ V)

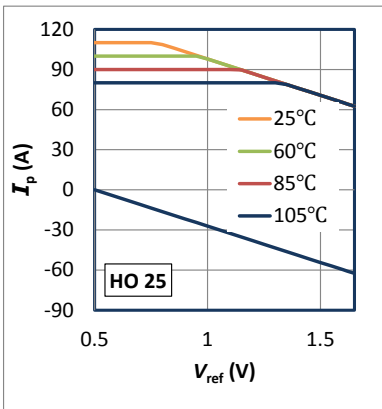

Upper limit:
 $T_A = 105^\circ\text{C}$

$I_p = 80$ ($V_{ref} = 0.5 \dots 1.328$ V)
 $I_p = -54.35 \times V_{ref} + 152.17$ ($V_{ref} = 1.328 \dots 1.65$ V)

$T_A = 85^\circ\text{C}$

$I_p = 90$ ($V_{ref} = 0.5 \dots 1.144$ V)
 $I_p = -54.35 \times V_{ref} + 152.17$ ($V_{ref} = 1.144 \dots 1.65$ V)

$T_A = 80^\circ\text{C}$

$I_p = 100$ ($V_{ref} = 0.5 \dots 0.96$ V)
 $I_p = -54.35 \times V_{ref} + 152.17$ ($V_{ref} = 0.96 \dots 1.65$ V)

$T_A = 25^\circ\text{C}$

$I_p = 110$ ($V_{ref} = 0.5 \dots 0.776$ V)
 $I_p = -54.35 \times V_{ref} + 152.17$ ($V_{ref} = 0.776 \dots 1.65$ V)

Lower limit:

$I_p = -54.35 \times V_{ref} + 27.17$ ($V_{ref} = 0.5 \dots 1.65$ V)

Example with $V_{ref} = 0.5$ V:

- The 8 A version has a measuring range from 0 A to 40 A
- The 15 A version has a measuring range from 0 A to 75 A
- The 25 A version has a measuring range from 0 A to 80 A at $T_A = 105^\circ\text{C}$

Example with $V_{ref} = 1.5$ V:

- The 8 A version has a measuring range from -17.4 A to 22.6 A
- The 15 A version has a measuring range from -32.6 A to + 42.4 A
- The 25 A version has a measuring range from -54.4 A to + 70.6 A

Application information

Total primary resistance

The primary resistance is 0.36 mΩ per conductor at 25 °C.

In the following table, examples of primary resistance according to the number of primary turns.

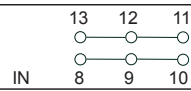
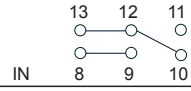
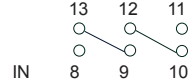
Number of primary turns	Primary resistance current rms R_p [mΩ]	Recommended connections	Primary nominal current I_{PN} [A]		
			8	15	25
1	0.12		8	15	25
2	0.54		4	7.5	12.5
3	1.18		2.67	5	8.33

Definition of typical, minimum and maximum values

Minimum and maximum values for specified limiting and safety conditions have to be understood as such as well as values shown in “typical” graphs. On the other hand, measured values are part of a statistical distribution that can be specified by an interval with upper and lower limits and a probability for measured values to lie within this interval.

Unless otherwise stated (e.g. “100 % tested”), the LEM definition for such intervals designated with “min” and “max” is that the probability for values of samples to lie in this interval is 99.73 %. For a normal (Gaussian) distribution, this corresponds to an interval between -3 sigma and +3 sigma. If “typical” values are not obviously mean or average values, those values are defined to delimit intervals with a probability of 68.27 %, corresponding to an interval between -sigma and +sigma for a normal distribution.

Typical, maximal and minimal values are determined during the initial characterization of a product.

Remark

Installation of the transducer must be done unless otherwise specified on the datasheet, according to LEM Transducer Generic Mounting Rules. Please refer to LEM document N°ANE120504 available on our Web site: [Products/Product Documentation](#).

HO-NSM/SP33 Series: name and codification

HO family products may be ordered **on request** ¹⁾ with a dedicated setting of the parameters described below (standards products are delivered with the setting 0000 according to the table).

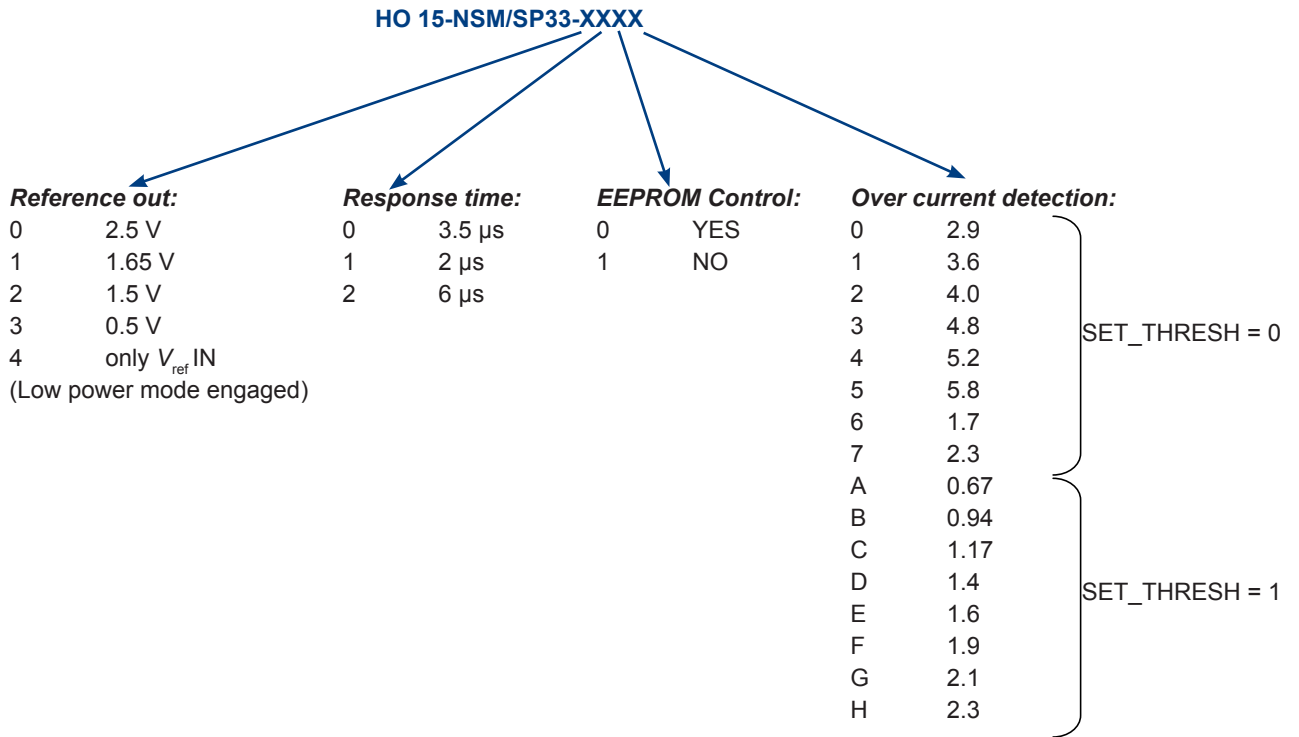

The products of this datasheet are the following references:

- HO 8-NSM/SP33-1000
- HO 15-NSM/SP33-1000
- HO 25-NSM/SP33-1000

Note: ¹⁾ For other dedicated settings, minimum quantities apply.

PCB Footprint

Reflow profile

(Example footprint) Top side view

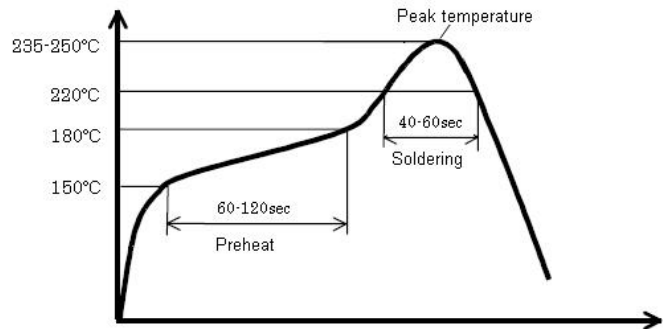
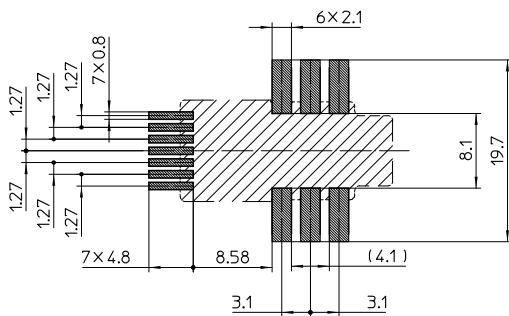

Safety

This transducer must be used in limited-energy secondary circuits according to IEC 61010-1.



This transducer must be used in electric/electronic equipment with respect to applicable standards and safety requirements in accordance with the manufacturer's operating instructions.



Caution, risk of electrical shock.

When operating the transducer, certain parts of the module can carry hazardous voltage (e.g. primary bus bar, power supply). Ignoring this warning can lead to injury and/or cause serious damage.

This transducer is a build-in device, whose conducting parts must be inaccessible after installation.

A protective housing or additional shield could be used.

Main supply must be able to be disconnected.

Dimensions HO 8-NSM/SP33, HO 15-NSM/SP33, HO 25-NSM/SP33
 (mm, general linear tolerance ± 0.5 mm)
