

---

# Photo-electric sensors

## OsiSense XU

### Catalogue



Simply easy!™

# Photo-electric sensors OsiSense XU

---

**Selection guide** ..... page 2

- Multimode: Simplicity through innovation ..... page 14
- General ..... page 16

## OsiSense XU, general purpose

- Design 18
  - Single mode function, plastic ..... page 28
  - Single mode function, metal ..... page 30
  - Multimode function, metal or plastic ..... page 32
- Miniature design
  - Single mode function, plastic ..... page 34
  - Multimode function, plastic ..... page 38
  - Diffuse mode with adjustable background and foreground ..... page 40
- Compact design, 50 x 50
  - Single mode function, plastic ..... page 42
  - Multimode function, plastic ..... page 44
  - Diffuse with adjustable background suppression ..... page 46
- Compact design, 92 x 77
  - Single mode function, plastic ..... page 50
  - Multimode function, plastic ..... page 52
  - Diffuse with adjustable background suppression ..... page 54

## OsiSense XU Application, fork and frame form

- Fork design
  - Optical fork without adjustment ..... page 56
  - Optical fork with teach mode ..... page 58
  - Optical fork with laser transmission and with teach mode ..... page 60
  - Ultrasonic fork, packaging series ..... page 62
  - Optical fork for detection of opaque labels ..... page 64
  - Optical fork with teach mode, packaging series ..... page 66
  - Optical fork with integral amplifier, mechanical handling series ..... page 70
- Frame design
  - Dynamic detection of passage of objects, conveying series ..... page 72

## OsiSense XU Application, packaging series

- Detection of contrast
  - Compact design 50 X 50 ..... page 74
  - Fibre design, with teach mode ..... page 76
  - Compact design 81 X 58 ..... page 78
- Luminescence sensor ..... page 80
- Illumination sensor ..... page 82
- For detection of transparent materials ..... page 84
- For detection of transparent materials, with teach mode ..... page 88
- For colour detection, sorting ..... page 90

## OsiSense XU Application, food and beverage series

- Design 18, stainless steel, multimode function ..... page 92
- Design 18, stainless steel, single mode ..... page 94
- Compact design, stainless steel, monomode ..... page 98

---

## OsiSense XU Application, assembly and conveying series

- Metal case, cylindrical, threaded M8 x 1 for assembly series . . . . . *page 102*
- Miniature design for conveyor system and access control series . . . . . *page 104*
- Miniature design with laser transmission for assembly series and conveyor system . . . . . *page 106*
- Compact design with laser transmission for assembly series . . . . . *page 108*
- Cylindrical design for detecting packages on a roller conveyor . . . . . *page 112*

## OsiSense XU Application, materials handling series

- Design 18, laser transmission . . . . . *page 116*
- With analogue output signal 4...20 mA and 0...10 V . . . . . *page 118*
- With analogue output signal 4...20 mA . . . . . *page 120*
- Laser transmission with solid-state and analogue output signal 4...20 mA . . . . . *page 122*
- Thru-beam system with high "excess gain" . . . . . *page 124*
- Laser transmission with analogue output signal 4...20 mA and 0...10 V . . . . . *page 126*
- Laser transmission with background suppression . . . . . *page 128*
- Diffuse with 2 channels using triangulation . . . . . *page 130*

## OsiSense XU Application, amplifier and fibre optics

- Amplifiers with teach mode . . . . . *page 132*
- "Plastic" fibre optics for amplifiers . . . . . *page 134*
- "Glass" fibre optics for amplifier . . . . . *page 142*
- Ecofibre system in "plastic" for customer assembly . . . . . *page 148*
- Amplifiers for plastic or glass fibre optics . . . . . *page 150*

## OsiSense XU Application, other formats

- Compact design, conveying serie . . . . . *page 152*
- Compact design for conveyor system and access control system . . . . . *page 154*
- Design 18, a.c. or d.c. supply, solid-state output with adjustable sensitivity . . . . . *page 156*

## OsiSense XU Application, tertiary sector series

- For access detection . . . . . *page 158*
- With integral buzzer . . . . . *page 160*

## OsiSense XU

- Accessories . . . . . *page 162*
- Curves . . . . . *page 172*

## Index

- Product reference index . . . . . *page 182*

# Photo-electric sensors

## OsiSense XU General purpose

### Single mode or multimode function

**Format**

**Design 18**

**Metal**

**Plastic**



Single mode function	
<b>Sensing distance (m) related to system</b>	Diffuse with adjustable sensitivity
	Diffuse
	Polarised reflex
	Reflex
	Thru-beam
<b>Type reference</b>	
<b>Pages</b>	

Type	Sensing distance (m)
XUB5B	0.6
XUB4B	0.1
XUB9B	2
XUB1B	4
XUB2B	15
<b>XUB●B (1)</b>	
<b>30</b>	

Type	Sensing distance (m)
XUB5A	0.6
XUB4A	0.1
XUB9A	2
XUB1A	4
XUB2A	15
<b>XUB●A (1)</b>	
<b>28</b>	

Multimode function	
<b>Sensing distance (m) related to system</b>	Diffuse with background suppression
	Diffuse
	Polarised reflex
	Thru-beam
<b>Type reference</b>	
<b>Pages</b>	

Type	Sensing distance (m)
XUB0B	0.12
	0.30
	3
	15
<b>XUB0B (1)</b>	
<b>32</b>	

Type	Sensing distance (m)
XUB0A	0.12
	0.30
	3
	15
<b>XUB0A (1)</b>	
<b>32</b>	

High performance diffuse with adjustable background suppression	
<b>Type reference</b>	
<b>Pages</b>	

Type	Sensing distance (m)
–	–
–	–
–	–

Type	Sensing distance (m)
–	–
–	–
–	–

Characteristics		
Dimensions (w x h x d) in mm		
<b>Case</b>	Materials	Plastic, PBT
		Nickel plated brass
		Stainless steel
Degree of protection		
<b>Supply</b>	≡ 3-wire (PNP/NPN)	
	⌋ 5-wire, relay output	
<b>Function</b>	NO	
	NC	
	NO/NC	
	NO + NC	
<b>Connection</b>	Pre-cabled (L = 2 m) (2)	
	Connector	M8 (4-pin) ≡ 3-wire
		M12
	Screw terminals	
Remote connector		

Ø 18, threaded M18 x 1 XUB●A/XUB●B: length 46 (62 for XUB5 and connector version) XUB0A/XUB0B: length 62 (pre-cabled version) or length 78 (connector version)	
–	●
●	–
● (XUB0S: see page 92)	–
IP 65, IP 67 IP 69K (XUB0S, stainless steel case, see page 92)	IP 65, IP 67
●	●
(2-wire XU●M18, see page 156)	–
●	●
●	●
–	–
–	–
●	●
–	–
●	●
–	–
–	–

M8 and M12 remote connectors available: please contact our Customer Care Centre.

(1) Sensors also available with line of sight 90° to case axis.  
 (2) Cable lengths of 5 and 10 m also available, depending on model.  
 (3) With adjustable sensitivity.

<b>Miniature design</b>	<b>Compact design, 50 x 50</b>	<b>Compact design, 92 x 71</b>
<b>Plastic</b>	<b>Plastic</b>	<b>Plastic</b>



Type	Sensing distance (m)
XUM5A	1 (3)
–	–
XUM9A	5 (3)
–	–
XUM2A	15 (3)
<b>XUM●A</b>	
34	

Type	Sensing distance (m)
XUK5A	1 (3)
–	–
XUK9A	6
XUK1A	7
XUK2A	30
<b>XUK●A</b>	
42	

Type	Sensing distance (m)
XUX5A	2 (3)
–	–
XUX9A	11 (3)
XUX1A	14 (3)
XUX2A	40 (3)
<b>XUX●A</b>	
50	

Type	Sensing distance (m)
XUM0A	0.10
	0.4
	3
	10
<b>XUM0A</b>	
38	

Type	Sensing distance (m)
XUK0A	0.28
	0.8
	4
	30
	–
<b>XUK0A</b>	
44	

Type	Sensing distance (m)
XUX0A	1.3
	2
	15
	40
<b>XUX0A</b>	
52	

Type	Sensing distance (m)
XUM8	0.3
<b>XUM8</b>	
40	

Type	Sensing distance (m)
XUK8AKSN	1
XUK8ARCT	0.75
<b>XUK8AKSN, XUK8ARCT</b>	
46 and 48	

Type	Sensing distance (m)
XUX8	2
<b>XUX8</b>	
54	

XUM●A: 11 x 34 x 20 (pre-cabled) or 11 x 43 x 20 (M8)		
XUM0A: 12 x 34 x 20 (pre-cabled) or 12 x 45 x 20 (M8)		
●		
–		
–		
IP 65, IP 67		
●		
–		
–		
–		
● configurable using switch and by programming (XUM0A)		
–		
●		
●		
–		
–		

18 x 50 x 50		
●		
–		
–		
IP 65		
●		
●		
●		
●		
● by programming (XUK0A and XUK8)		
● relay output		
●		
–		
●		
–		

31 x 92 x 77		
●		
–		
–		
IP 65, IP 67		
●		
●		
●		
●		
● by programming (XUX0A and XUX8)		
● relay output		
–		
–		
●		
●		

M8 and M12 remote connectors available: please contact our Customer Care Centre.

## Photo-electric sensors OsiSense XU Application Fork and frame form

**Recommended applications**

**Detection of objects on small conveyors**

**Detection of labels on strip.  
Detection of sheet feed on printing machine**

**Detection on vibrating rail.  
Detection of transparent objects**

**Detection of transparent labels**



<b>Format</b>
<b>Dimensions (w x h x d) in mm</b>
<b>Case</b>
<b>Sensing distance (mm) related to system</b>
Diffuse with background suppression
Diffuse
Polarised reflex
Reflex
Thru-beam
<b>Degree of protection</b>
<b>Supply</b>
DC
AC
<b>Output</b>
<b>Connection</b>
Pre-cabled
Connector
Screw terminals
<b>Type reference</b>
<b>Pages</b>

Optical fork	Optical fork	Laser optical fork	Ultrasonic fork
Passageway: 30 to 180 Depth: 30, 60, 95	Passageway: 2 to 120 Depth: 42, 59, 95		18 x 47.3 x 92.5
Metal	Metal	Metal	Metal
–	–	–	–
–	–	–	–
–	–	–	–
2... 180 (2)	2... 120 (1) (2)	2... 120 (1) (2)	3
IP65, IP 67	IP 65	IP 65	IP 65
•	•	•	•
–	–	–	–
–	–	–	–
PNP/NPN NO/NC	PNP/NPN (3) NO/NC (4)	PNP/NPN (3) NO/NC (4)	PNP and NPN NO/NC (4)
•	–	–	–
•	•	•	•
–	–	–	–
<b>XUVR● XUVA●</b>	<b>XUYFNFP● XUYFANFP●</b>	<b>XUYFLNFP● XUYFALNFP●</b>	<b>XUVU06</b>
56	58	60	62

(1) With or without teach mode, depending on model.  
 (2) Depending on model.  
 (3) Depending on wiring.  
 (4) By programming.

<b>Detection of opaque labels, of different colours</b>	<b>Detection of opaque labels</b>	<b>Detection of flags in lifts and transtockers. Integrated amplifier</b>	<b>Material handling: detection and counting of objects being fed to or exiting a machine</b>
---	-----------------------------------	---	---



Optical fork	Optical fork	Optical fork	Optical fork	Frame design
10 x 25 x 64	20 x 26 x 90	12 x 37.5 x 80	14 x 58 x 68	15 x 50 x 108 15 x 86 x 131 25 x 230 x 205/265/335
Plastic	Metal	Metal	Plastic	Metal
–	–	–	–	–
–	–	–	–	–
–	–	–	–	–
–	–	–	–	–
3	2	3 or 5 (2)	3	3, 6, 12, 18, 25 (2)
IP 65	IP 65	IP 65	IP 54	IP 65
●	●	●	●	●
–	–	–	–	–
–	–	–	–	–
PNP and NPN NO/NC (4)	PNP and NPN NO/NC (4)	PNP and NPN NO/NC (4)	Solid-state PNP or NPN NO	PNP and NPN NO/NC (3)
–	–	–	●	–
●	●	●	–	●
–	–	–	–	–
<b>XUVE</b>	<b>XUVK</b>	<b>XUYFA98●</b>	<b>XUVH XUVJ</b>	<b>XUVF</b>
64	66	68	70	72

**Recommended applications**

Packaging			
Colour mark readers			Luminescence sensors
Detection of reference marks, contrasting colours and markings on packaging, printing, labelling machines, etc.	Detection of reference marks on packaging paper, tubes	Detection of reference marks, contrasting colours and markings on packaging, printing, labelling machines, etc.	Detection of invisible reference marks, markings, adhesives, varnishes, etc. Sensitive to the bluing agents generally present in inks, adhesives, varnishes, etc.



<b>Format</b>	
<b>Dimensions (w x h x d) in mm</b>	
<b>Case</b>	
<b>Sensing distance (m) related to system</b>	Diffuse with background suppression
	Diffuse
	Polarised reflex
	Reflex
	Thru-beam
<b>Degree of protection</b>	
<b>Supply</b>	⎓
	~
	⌚
<b>Output</b>	
<b>Connection</b>	Pre-cabled
	Connector
	Screw terminals
<b>Type reference</b>	
<b>Pages</b>	

Compact design	Fibre design	Compact design	Design 18
50 x 50 x 15	13 x 72 x 30	31 x 81 x 58	Ø 18, threaded M18 x 1 L: 82
Plastic	Plastic	Metal	
–	–	–	–
0.019	(1)	0.009	0.02
–	–	–	–
–	–	–	–
–	–	–	–
IP 65	IP 65	IP 67	IP 67
•	•	•	•
–	–	–	–
–	–	–	–
Solid-state (PNP or NPN)			Solid-state (PNP)
–	–	–	–
•	•	•	•
–	–	–	–
<b>XUKR</b>	<b>XUYDCF ●●966S</b>	<b>XURK</b>	<b>XU5M</b>
74	76	78	80

(1) Depending on fibres used.  
(2) Depending on model.



Packaging		
<b>Illumination sensors</b>	<b>Detection of any transparent object</b>	<b>For detection of colours, sorting</b>
Verifying operation of indicator lights	Bottles, flasks, containers, films, etc.	Recognises colours for sorting or checking parts



Fibre design	Design 18	Miniature design	Compact design, 50 x 50	Compact design
13 x 76.7 x 30	Ø 18, threaded M18 x 1 L: 64, 78 or 92	11 x 43 x 20	18 x 50 x 50	50 x 50 x 25
Plastic	Plastic or stainless steel (2)	Plastic	Plastic	Plastic
Sensing distance depending on fibre used	–	–	–	–
	–	–	–	0.020
	0...1.4	–	–	–
	–	0.1...2 (depending on reflector)	1.5	–
	–	–	–	–
IP 65	IP 65 IP 67	IP 67	IP 65	IP 65
•	•	•	•	•
–	–	–	–	–
–	–	–	–	–
PNP/NPN NO/NC (programmable)	Solid-state (PNP or NPN)	PNP/NPN NO/NC (programmable)	Solid-state (PNP or NPN)	
–	•	•	•	–
•	•	•	•	•
–	–	–	–	–
<b>XUYAFL</b> ●●966S	<b>XUBT</b>	<b>XUMT</b>	<b>XUKT</b>	<b>XUKC</b>
82	84	86	88	90

Recommended applications	<b>Food processing</b>	<b>Assembly</b>
	<b>Stainless steel cylindrical sensor (grade 304 CU)</b> For use in vicinity of food processing machinery	<b>Stainless steel case, grade 316 L</b>



<b>Format</b>		Design 18	Design 18	Compact design, 50 x 50	Design 8
<b>Dimensions (w x h x d) in mm</b>		Ø 18, threaded M18 x 1 L: 64...92	Ø 18, threaded M18 x 1 L: 62...88	50 x 50 x 23	Ø 8, threaded M8 x 1 L: 40
<b>Case</b>		Stainless steel	Stainless steel	Stainless steel	Metal
<b>Sensing distance related to system</b>	Diffuse with background suppression	0.12 m	–	3...550 mm	–
	Diffuse	0.3 m	0.10 m	–	0.05 m
	Polarised reflex	2 m	2 m	0.4...13 m	–
	Reflex	–	4 m	–	–
	Thru-beam	15 m	15 m	0...20 m	2 m
<b>Degree of protection</b>		IP 67, IP 69K	IP 67	IP 67, IP 69K	IP 65 (2) IP 67 (2)
<b>Supply</b>	☰	●	●	●	●
	~	–	–	–	–
	~	–	–	–	–
<b>Output</b>		Solid-state (PNP and NPN)	Solid-state (PNP and NPN)		Solid-state (PNP or NPN)
<b>Connection</b>	Pre-cabled	●	●	–	●
	Connector	●	●	●	●
	Screw terminals	–	–	–	–
<b>Type reference</b>		<b>XUB0S●</b>	<b>XU●N18</b>	<b>XUK●S</b>	<b>XUA</b>
<b>Pages</b>		92	94	98	102

Assembly	Conveying and assembly		
Detection of objects on conveyor and access control	Miniature, laser with teach mode	Long range laser	Detection of objects on conveyor



Miniature design	Miniature design	Compact design	Cylindrical design
20 x 32 x 13 10 x 40 x 13.5	12 x 32 x 20	23 x 50 x 50	250...900
Plastic	Plastic	PC Shock-resistant ABS	Aluminium and PA
0.015...0.08 m	20...60 mm 30...110 mm	5...800 mm	–
0.03...0.25 m	–	5...1200 mm	0...0.1 m
1 m	100...1000 mm	0.3...12 m	–
–	–	–	–
4 m	15 m	0...25 m	–
IP 65 IP 67	IP 67	IP 67 IP 69K	IP 50 (IP 65 on request)
•	•	•	•
–	–	–	–
–	–	–	–
PNP or NPN NO/NC (1)	PNP	PNP	Solid-state (PNP or NPN)
•	•	–	•
•	•	•	M8 and M12 remote connector (other connectors available on request)
–	–	–	–
<b>XUY●●989</b>	<b>XUY●●●929</b>	<b>XUK●LA●●</b>	<b>XUY●●●N●●●</b>
104	106	108	112

<b>Recommended applications</b>	<b>Material handling</b>		
	<b>Laser</b>	<b>Diffuse with analogue output</b>	<b>Laser</b>
		Measurement, servo control, position control, eccentricity monitoring, concentricity monitoring, etc.	Time of flight measurement



<b>Format</b>	Design 18	Compact design	Design 18	Design 90 x 90
<b>Dimensions (w x h x d) in mm</b>	Ø 18, threaded M18 x 1	27 x 85 x 61	Ø 18, threaded M18 x 1 L: 82	42 x 93 x 95
<b>Case</b>	Plastic or brass (2)	Plastic	Metal	ABS
<b>Sensing distance (m) related to system</b>	Diffuse with background suppression	–	–	–
	Diffuse	–	0.05...0.4	0.2...6
	Polarised reflex	–	–	0.2...30
	Reflex	–	–	–
	Thru-beam	0...100 with teach mode	–	–
<b>Degree of protection</b>	IP 67	IP 67	IP 67	IP 67
<b>Supply</b>	•	•	•	•
	–	–	–	–
	–	–	–	–
<b>Output</b>	PNP, NPN NO/NC by programming	Analogue (PNP)	–	Solid-state PNP (2 outputs) + analogue
	•	–	–	–
<b>Connection</b>	•	–	•	•
	–	•	–	–
	–	–	–	–
<b>Type reference</b>	<b>XUBL</b>	<b>XUJ</b>	<b>XU5M</b>	<b>XUE•AA2</b>
<b>Pages</b>	116	118	120	122

(1) Depending on model.

Material handling				Conveying
<b>Thru-beam with high excess gain</b>	<b>Laser transmission</b>	<b>Diffuse with background suppression, laser transmission</b>	<b>Diffuse with 2 channels using triangulation, with background suppression</b>	
Detection of objects in harsh environments (smoke, dust, mist, etc.). Measuring opacity	Monitoring dimensions in series, monitoring roundness of a wheel	High precision, detection of any dark or shiny object, including small sized		



Design 18	Compact design, 50 x 50	Compact design	Compact design	–
Ø 18, threaded M18 x 1 L: 82	17 x 50 x 50	18 x 60 x 60	18 x 60 x 60	29 x 95 x 60
Metal	Plastic	Plastic	Plastic	Plastic
–	–	Adjustable from 50 to 300 mm	Adjustable from 50 to 600 mm	–
–	0.04...0.06 0.045...0.085 0.08...0.3	–	–	1.5 or 4 (1)
–	–	–	–	6 or 10 (1)
–	–	–	–	–
50	–	–	–	●
IP 67	IP 67	IP 65	IP 65	IP 65 and IP 67
●	●	●	●	●
–	–	–	–	●
–	–	–	–	–
Solid-state (PNP) + analogue	Solid-state (PNP) + analogue	PNP and NPN NO/NC depending on wiring	PNP and NPN NO/NC programmable	PNP/NPN Relay NO/NC programmable
–	–	–	●	–
●	●	●	●	–
–	–	–	–	●
<b>XU2M</b>	<b>XUY●●925</b>	<b>XUYPS1●</b>	<b>XUYPS2●</b>	<b>XUY● 952/954</b>
124	126	128	130	154

### Recommended applications

### Amplifier and fibre optics



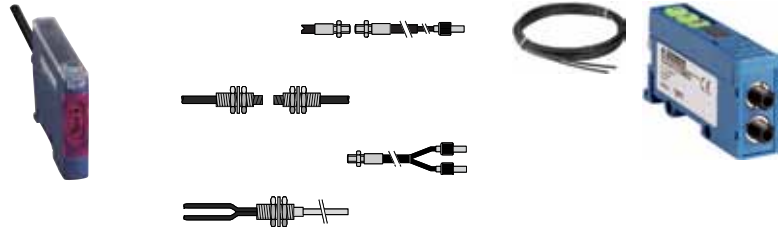

Amplifier, teach mode	Plastic fibres with end fittings	Glass fibres with end fittings	Ecofibre concept Bare fibres and end fittings supplied separately for customer assembly	Amplifier, teach mode or potentiometer
-----------------------	----------------------------------	--------------------------------	--	--



<b>Format</b>	
<b>Dimensions (w x h x d) in mm</b>	
<b>Case</b>	
<b>Sensing distance (m) related to system</b>	Diffuse with background suppression
	Diffuse
	Polarised reflex
	Reflex
	Thru-beam
<b>Degree of protection</b>	
<b>Supply</b>	☐
	~
	~
<b>Output</b>	
<b>Connection</b>	Pre-cabled
	Connector
	Screw terminals
<b>Type reference</b>	
<b>Pages</b>	

Fibre design	–	–	–	Fibre design
10 x 40 x 65 (amplifier)	Length (1): 1 m, 2 m or 10 m	Length (1): 0.60 m, 1 m, 1.5 m or 2 m	Length (1): 1 m, 10 m or 50 m	13 x 72.2 x 30 13 x 76.7 x 30
Plastic	Plastic	Glass	Plastic	Plastic
–	–	–	Sensing distance: 70 mm to 4000 mm (1)	Sensing distance depends on fibre used
0.006 to 0.095 (2)	6 to 95 (1)	80	–	–
–	–	–	–	–
–	–	–	–	–
0.050 to 2 (2)	30 to 2500 (1)	80 or 200 (1)	–	–
IP 65 (amplifier) IP 64 (fibres)	IP 64, IP641 (1) IP 65, IP651 (1)	–	–	IP 65
•	–	–	–	•
–	–	–	–	–
–	–	–	–	–
Solid-state (PNP or NPN) (3) NO or NC (programmable)	–	–	–	PNP/NPN NO/NC depending on wiring or programmable depending on model
•	–	–	–	•
•	–	–	–	•
–	–	–	–	–
<b>XUDA</b>	<b>XUF</b>	<b>XUYFV●</b>	<b>XUYA● XUYFP●</b>	<b>XUY AF●966 AF●946</b>
132	134	142	148	150

(1) Depending on model.  
 (2) Depending on fibre.  
 (3) Depending on wiring.  
 (4) With audible signalling (buzzer): reference **XUJB** (see page 160).

Building, tertiary sectors		Accessories		
2-wire AC or DC supply	Motion detection, relay output. With audible signalling (buzzer) (4)	Reflectors	Fixing brackets, clamps and kits	Protective covers
				
Design 18	Compact design			
Ø 18, threaded, M18 x 1 L: 82...110	18 x 50 x 50 (XUK1AR) 27 x 85 x 61 (XUJB)			
Metal	Plastic			
0.12	–			
0.4	–			
2	–			
–	7 with 50 x 50 reflector (XUK1AR) 6 (XUJB)			
15	–			
IP 67	IP 65 (XUK1AR) IP 40 (XUJB)			
–	–			
–	–			
•	•			
Solid-state	1 NO/NC programmable relay (XUK1AR) 1 NO relay (XUJB)			
•	• (XUK1AR)			
•	–			
–	• (XUJB)			
<b>XU●M18</b>	<b>XUK1AR, XUJB (4)</b>	<b>XUZC●, XUZB●</b>	<b>XUZA●, XUZB●, XUZE●, XUZX●, XULZ●, XUZM●</b>	<b>XUZD●●, XUJZ01</b>
156	158, 160	162	164	164

# Photo-electric sensors

## OsiSense XU

**Multimode:** Simplicity through innovation

### Principle

In proposing multimode products, Telemecanique Sensors offers simplicity through innovation.

■ With the multimode function, a single product meets all the requirements for optical detection. Effectively, by simply pressing the “Teach mode” button, the sensor automatically acquires optimum configuration for the application requirements

- 1 Diffuse system detection of object.
- 2 Diffuse system, with background suppression, detection of object.
- 3 Reflex system (reflector accessory) detection of object.
- 4 Thru-beam system, on optical receiver (transmitter accessory for thru-beam use), detection of object.

■ In addition to this, a multimode sensors also means:

- improved performance: maximum sensing distance guaranteed and optimised for each application,
- simplified use: intuitive setting-up plus less and easier maintenance,
- lower costs: the number of references is divided by 10 and, consequently, selection and supply is simplified and storage costs significantly reduced,
- guaranteed maximum productivity.

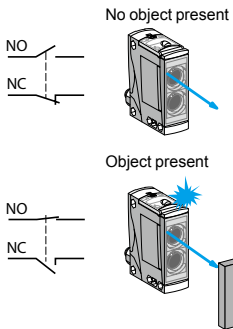
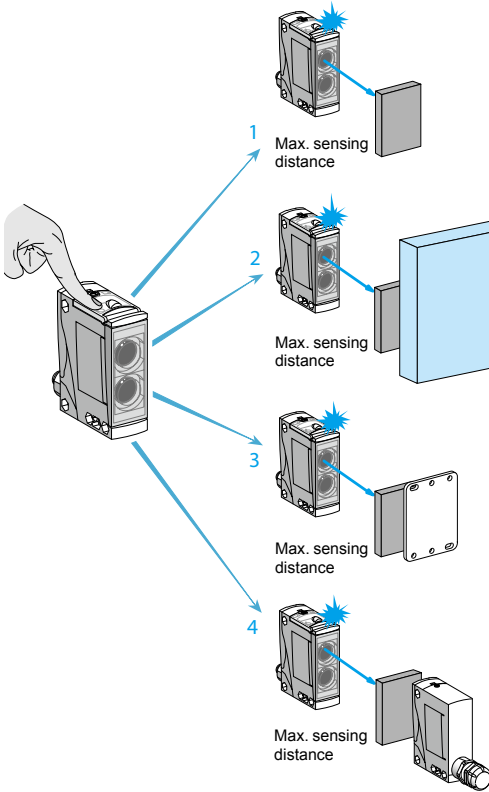

### Straightforward NO or NC output

■ Irrespective of the detection mode used (diffuse, reflex, thru-beam, etc.), the outputs become either NO or NC (1).

■ A multimode sensor means immediate and intuitive setting-up that is accessible to all.

(1) The sensor is supplied in NO configuration. NO or NC selection is performed by simply pressing the Teach mode button.

### Fixing accessories

A complete range of inexpensive mounting accessories (clamps, traditional or 3D brackets, etc.) is available that provides solutions for all installation and adjustment problems

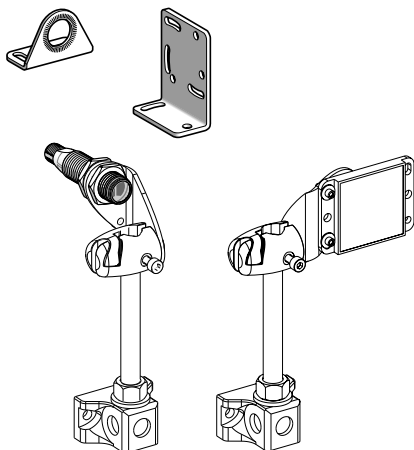



#### Design

Cylindrical 18	Miniature	Compact 50 x 50	Compact 92 x 77
----------------	-----------	-----------------	-----------------



Dimensions (w x h x d) in mm		M18 x 64	12 x 34 x 20	18 x 50 x 50	30 x 92 x 77
Maximum sensing distance in m	Without accessory with background suppression	0.12	0.10	0.28	1.3
	Without accessory	0.4	0.55	1.2	3
	With polarised reflector	3	4	5.7	15
	With thru-beam accessory	20	14	35	60
Supply	⎓ Solid-state output	■	■	■	■
	~ Relay output	–	–	■	■
Connection	Pre-cabled	■	■	■	–
	Connector	■	■	■	■
	Screw terminals	–	–	–	■
Sensor type		<b>XUB0</b>	<b>XUM0</b>	<b>XUK0</b>	<b>XUX0</b>
Pages		32	38	44	52

#### Sensing distances (see table above)

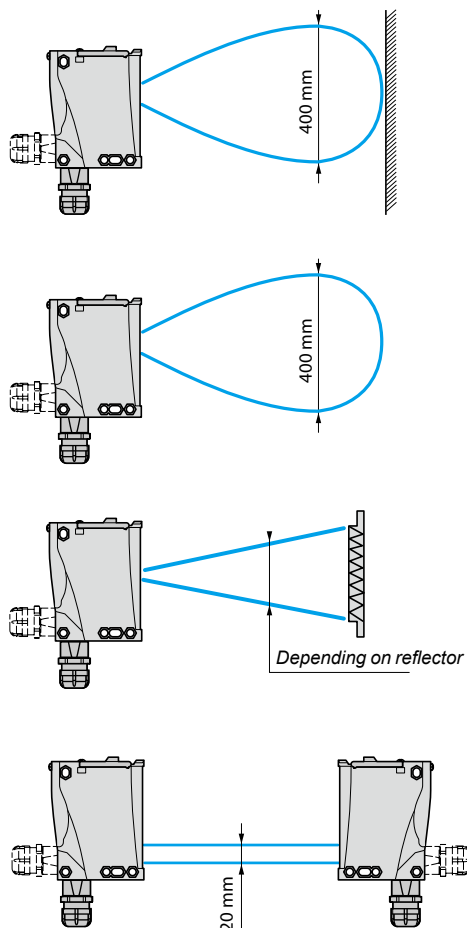

#### Sensing distance without accessory with background suppression

- Without accessory, the multimode sensor detects objects irrespective of their colour or background.
- A clean environment is recommended

#### Sensing distance without accessory

- Beyond the sensing distance with background suppression, the same multimode sensor without accessory detects objects but may be influenced by the backgrounds and colour of the objects to be detected.

#### Sensing distance with polarised reflector

- By installing a reflector opposite, the same multimode sensor detects objects irrespective of their shininess and colour.
- The size of the reflector must be smaller than that of the object to be detected.
- The larger the area of the reflector the longer the sensing distance.

#### Sensing distance with thru-beam transmitter accessory

- After setting-up and connecting a thru-beam transmitter accessory opposite, the same multimode sensor detects objects irrespective of their shininess, colour or background.
- The detection distance is a maximum.
- The sensor and the thru-beam transmitter must be carefully aligned.
- Good resistance to accumulation of dirt and dust.

### Standards and certifications

#### Parameters related to the environment

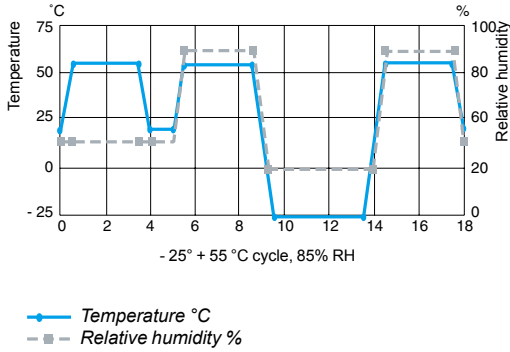

### Recommendation

The sensors detailed in this catalogue are designed for use in standard industrial applications relating to presence detection. These sensors do not incorporate the required redundant electrical circuit enabling their usage in safety applications. For safety applications, please refer to our "Safety solutions using Preventa" catalogue.

### Quality control

**Our photo-electric sensors are subject to special precautions in order to guarantee their reliability in the most arduous industrial environments.**

- **Qualification**
  - The product characteristics stated in this catalogue are subject to a **qualification procedure** carried out in our laboratories.
  - In particular, the products are subjected to **climatic cycle** tests for 3000 hours whilst powered-up to verify their ability to maintain their characteristics over time.
- **Production**
  - The electrical characteristics and sensing distances at both ambient temperature and extreme temperatures are 100% checked.
  - Products are randomly selected during the course of production and subjected to **monitoring tests** relating to all their characteristics.
- **Customer returns**
  - If, in spite of all these precautions, defective products are returned to us, they are subject to **systematic analysis** and **corrective actions** are implemented to eliminate the risks of the fault recurring.

### Immunity to ambient light

■ OsiSense XU photo-electric sensors use the pulsed light principle. This provides a high degree of immunity to spurious light that conforms to standard **IEC 60947-5-2**.

### Resistance to electromagnetic interference

The photo-electric sensors are tested in accordance with the recommendations of the standard **IEC 60947-5-2**

- Electrostatic discharges

**IEC/EN 61000-4-2**

⌚ 15 kV version, level 4  
 ⌚ 8 kV version, level 3

- Radiated electromagnetic fields (electromagnetic waves)

**IEC/EN 61000-4-3**

10 V/metre, level 3

- Fast transients in salvos (motor start/stop interference)

**IEC/EN 61000-4-4**

2 kV, level 4

- Impulse voltages, lightning

**IEC 60947-5-2**

⌚ 2.5 kV version  
 ⌚ 1 kV version

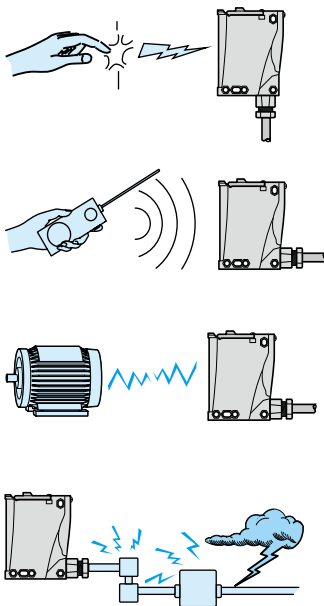

### Mechanical shock resistance

The sensors are tested in accordance with standard IEC 60068-2-27, 30 gn, duration 11 ms.

### Vibration resistance

The sensors are tested in accordance with standard IEC 60068-2-6, 7 gn, amplitude ± 1.5 mm, f = 10...55 Hz.

### Resistance to chemicals in the environment

■ Owing to the very wide range of chemicals encountered in industry, it is very difficult to give general guidelines common to all sensors.  
 ■ To ensure lasting efficient operation, it is essential that any chemicals coming into contact with the sensors will not affect their casing and, in doing so, prevent their reliable operation (please refer to the characteristics pages for the various sensors).  
 In all cases, the materials selected (see product characteristics) provide satisfactory compatibility in most industrial environments (for further information, please consult our Customer Care Centre).

### Principle of optical detection

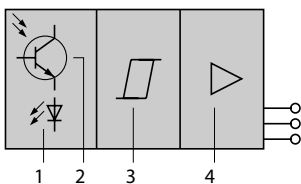

- 1 Light beam transmitter
- 2 Light beam receiver
- 3 Signal processing stage
- 4 Output stage

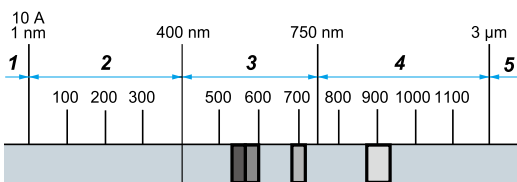

- 1 X rays, 2 Ultraviolet, 3 Visible light,
- 4 Near infrared, 5 Far infrared

### Detection systems

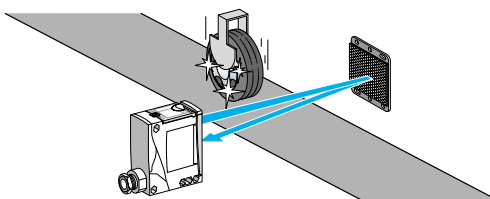
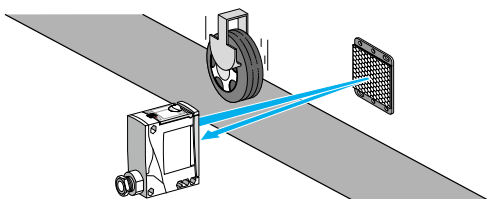
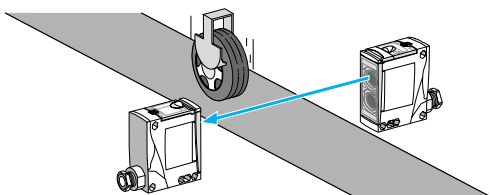

### Composition of a photo-electric sensor

A photo-electric sensor basically comprises a light beam transmitter (light-emitting diode) and a light-sensitive receiver (photo-transistor).

A light-emitting diode is an electronic semi-conductor component that emits light when an electric current flows through it. This light can be visible or invisible, depending on the transmission wavelength.

Detection occurs when an object enters the transmitted light beam and, in so doing, affects the intensity of the light at the receiver. As the light intensity at the receiver decreases a point is reached whereby the output of the sensor changes state.

### Light spectrum

Depending on the model and application requirements, the transmission beam is either non visible infrared (most common case) or ultraviolet (detection of luminescent materials). It may also be visible red or green (colour mark reading etc.) and laser red (long sensing distance and short focal length).

### Modulation

The advantage of LEDs is their very fast response. To render the system insensitive to ambient light, the current flowing through the LED is modulated so as to produce a pulsed light transmission.

Only the pulsed signal will be used by the photo-transistor and processed to control the load.

### Thru-beam system or multimode with thru-beam accessory

#### Advantages

- Long sensing distance (up to 60 m).
- Very precise detection, high repeat accuracy.
- Detection not affected by colour of object.
- Good resistance to difficult environments (dust, grime, etc.).

#### Drawbacks

- 2 units to be wired.
- The object to be detected must be opaque.
- Precise alignment required, which can be difficult since the sensor transmits in the infrared range (invisible).

#### Operating precautions

- When several sensors are used, care must be taken to ensure that no sensor is disrupted by another sensor (e.g. alternate mounting of transmitter/receiver etc.).

#### Advantages of multimode sensor with thru-beam accessory

- Easy alignment
- The sensor transmits in the visible red range during the alignment phase.
- 3 LEDs providing setting-up assistance.

### Polarised reflex system or multimode with reflector accessory

#### Advantages

- Medium sensing distance (up to 15 m).
- Precise detection.
- Only one unit to be wired.
- Detection not affected by colour of object.
- Visible red beam transmission.

#### Drawbacks

- Precise alignment required.
- The object to be detected must be opaque and larger than the reflector.

#### Operating precautions

- When several sensors are used, they must be aligned in such a manner that no sensor is disrupted by another sensor.
- For short distance detection use a reflector with large trihedrons, type XUZC24.
- For long distance detection use a reflector XUZC50 or XUZC80.
- To increase the sensing distance use reflector XUZC100.
- If reflective tape is used, use rolls of tape XUZB1 or XUZB15 which are specially adapted for polarised reflex systems.

#### Advantages of multimode sensor with reflector accessory

- Easy alignment
- 3 LEDs providing setting-up assistance.
- The anti-interference function enables 2 sensors to be used without specific alignment precautions.
- Semi-transparent objects can be detected by using the teach mode function.

### Detection systems (continued)

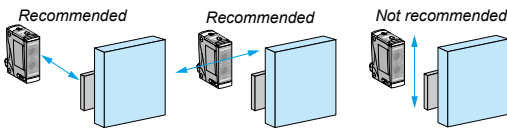
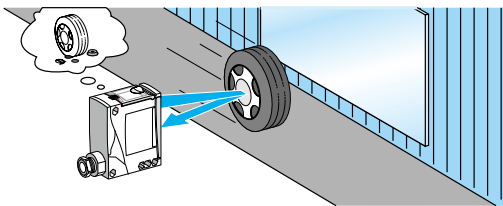
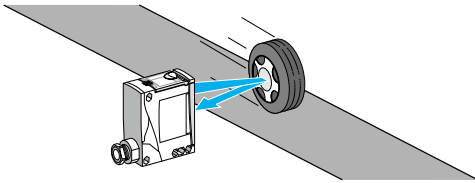

Positioning recommendations for sensor with background suppression

### Specific systems

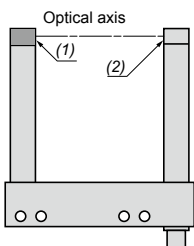

(1) Transmission LED  
(2) Output LED

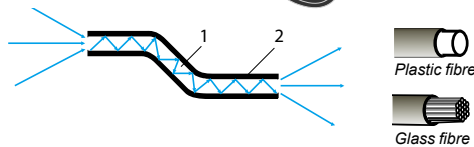

1 Core  
2 Sheath

### Diffuse system or multimode

- **Advantage**
  - Only one unit to be wired.
- **Drawbacks**
  - Short sensing distance.
  - Sensitivity to object or background colour differences.
  - Object sighting line difficult since the sensor transmits in the infrared range (invisible).
- **Operating precautions**
  - When several sensors are used, they must be aligned in such a manner that no sensor is disrupted by another sensor.
- **Advantages of a multimode sensor**
  - Easy alignment:
    - the sensor transmits in the visible red range during the alignment phase,
    - 3 LEDs providing setting-up assistance,
    - the anti-interference function enables 2 sensors to be used without specific alignment precautions.
  - Refined detection: the position of the object can be detected using the teach mode.

### Diffuse, with or without background suppression, system or multimode

- **Advantages**
  - Only one unit to be wired.
  - Detection not affected by colour of object or background.
- **Drawbacks**
  - Short sensing distance.
  - Object sighting line difficult since the sensor transmits in the infrared range (invisible).
- **Operating precautions**
  - Detection can be affected by the object's direction of movement. To overcome this phenomenon (the hat effect), it is recommended that the sensor is mounted so that the object simultaneously breaks the beam of both lenses.
  - When several sensors are used, they must be aligned in such a manner that no sensor is disrupted by another sensor.
- **Advantages of a multimode sensor**
  - Easy alignment:
    - the sensor transmits in the visible red range during the alignment phase,
    - 3 LEDs providing setting-up assistance,
    - the anti-interference function enables 2 sensors to be used without specific alignment precautions,
    - the hat effect is minimised using the background teach mode.
  - Refined detection: the position of the object can be detected using the teach mode.

### Optical forks

- Constructed from metal, the optical fork is a robust sensor that is particularly suited to conveying and packaging applications and detection of labels.
- Rugged optical detection device **not requiring alignment** in thru-beam mode.
- The beam from the transmitter limb is transmitted to the receiver limb. Due to its construction, **only one connection** is required as opposed to two for a traditional thru-beam function.
- The transmission sources are LEDs of various technologies:
  - Red for much improved efficiency during adjustment and maintenance
  - Red laser for detection of transparent materials or very small parts
  - Infrared, particularly for optical frames
  - Ultrasonic for detection of transparent labels (clear on clear)
- The beam is adjustable or fixed depending on the version. Adjustment enables the sensitivity to be altered and, therefore, detection of small parts down to dimensions of less than tenths of millimetres (minimum size of detectable object: 0.05 mm).
- The high switching frequency (from 4 kHz up to 25 kHz) is very useful in industrial applications involving high operating rates.

### Fibre optics

- The fibre acts as a light conductor. Light rays entering the fibre at a certain angle are conveyed to the required location, with minimum loss.
- Separate amplifier.
  - Size kept to minimum.
  - This system enables detection of very small objects (approximately 1 mm).
  - And, detection is very precise.

#### Plastic fibres

- The core of the fibre is flexible plastic (PMMA). In general, there is only a single fibre of diameter 0.25 to 1 mm, depending on the model.
- Fibres are used with amplifiers transmitting red light.
  - Minimum bend radius:
    - 10 mm for fibres with 0.25 mm diameter core,
    - 25 mm for fibres with 1 mm diameter core.
  - **Advantages:** fibres can be cut to the required length.

#### Glass fibres

- The core of the fibre is silica. For maximum flexibility, each fibre comprises numerous strands that are approximately 50 µ in diameter.
- Fibres are used with amplifiers transmitting infrared or red light.
- Minimum bend radius:
  - 10 mm with plastic sheath,
  - 90 mm with stainless steel sheath.
- **Advantages**
  - Fibres suitable for use at high temperatures (250 °C).
  - Fibres with stainless steel sheath provide protection against mechanical impact and crushing.

### Detection curves

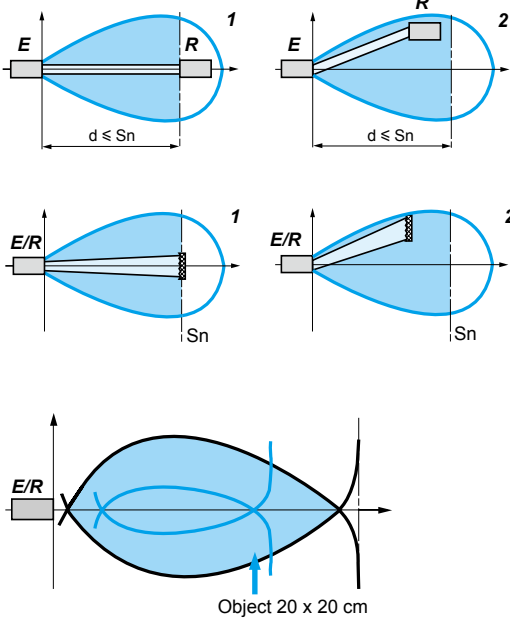

### Thru-beam system

- The zone indicates the positioning tolerance of the receiver.
  - The zone represents the usable sensing zone of the system. Any opaque object entering this zone breaks the beam and causes the sensor's output to change state.
- Ideal detection
  - Acceptable detection
- T = transmitter  
R = receiver

### Polarised reflex system

- The zone indicates the positioning tolerance of the reflector.
  - The zone represents the usable sensing zone of the system. Any opaque object entering this zone breaks the beam and causes the sensor's output to change state.
- Ideal detection
  - Acceptable detection
- T = transmitter  
R = receiver

### Diffuse, with or without background suppression, system

- The zone represents the sensor's sensitivity zone.
- All of this zone is usable: any object that is adequately reflective entering this zone, in the direction of the arrow, will cause the sensor's output to change state. The black line corresponds to a light colour surface and the blue line to a darker colour surface.
- A test using the object to be detected will determine the zone of sensitivity in relation to its reflection coefficient.
- White 90% object
  - Grey 18% object
- For specific aspects of diffuse systems see page 18.
- T = transmitter  
R = receiver

### Excess gain

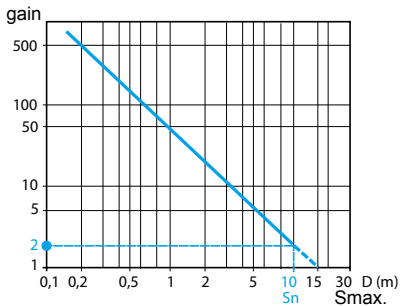

### Operating margin

To ensure correct operation of a sensor in spite of environmental constraints, the sensors feature an operating margin.

This margin can be expressed in terms of excess gain, which is the ratio:

Excess gain = Signal level received / Signal required for switching.

#### For all OsiSense XU sensors

- The **nominal sensing distance Sn** is defined as the sensing distance with an **excess gain of 2**, i.e. the sensing distance for which the sensor receives twice as much light energy as it strictly needs to switch it.
- The **maximum sensing distance** is defined as the sensing distance with an **excess gain of 1**. It corresponds to the maximum detection value.

The use of the sensor at the nominal sensing distance ensures the sensor's correct operation in normal operating conditions.

In extreme conditions, refer to the following setting-up recommendations:

- clean environment: work at nominal sensing distance Sn,
- slightly polluted environment: work at sensing distance Sn/2,
- moderately polluted environment: work at sensing distance Sn/4,
- heavily polluted environment: preferably use multimode sensors with thru-beam accessory (or the thru-beam system) with a sensing distance Sn/10.

### Optical alignment aid

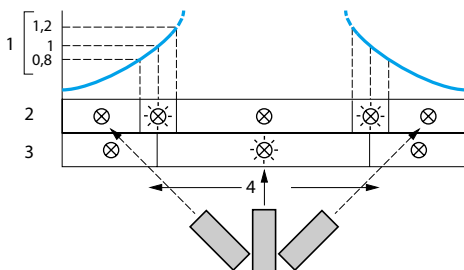

A red LED assists setting-up by illuminating when optimum alignment of the sensor is achieved.

- Signal level
- Red LED, on off
- Green LED, on off
- Optimum alignment

### Detection distance using reflector

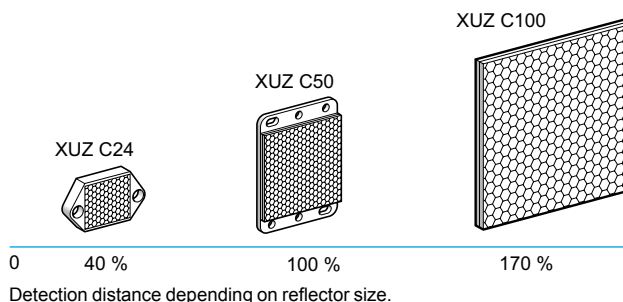

### Outputs

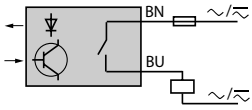

### 2-wire technique ~ or ~

■ **Specific aspects**

These sensors are wired in series with the load to be switched. As a consequence, they are subject to:

- A residual current in the open state (current flowing through the sensor in the “open” state),
- A voltage drop in the closed state (voltage drop across the sensor’s terminals in the “closed” state).

■ **Advantages**

- Only 2 wires to be connected. They can be wired in series in the same way as mechanical limit switches.
- For use on 2-wire  $\overline{\text{---}}$ , they can be connected to either positive (PNP) or negative (NPN) logic PLC inputs.
- No risk of incorrect connections.

■ **Operating precautions**

- Check the possible effects of residual current and voltage drop on the actuator or input connected.
- These sensors do not incorporate overload or short-circuit protection and therefore, it is essential to connect a 0.4 A “quick-blow” fuse in series with the load.

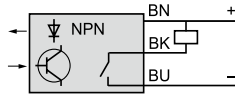
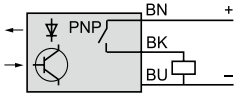

### 3-wire technique $\overline{\text{---}}$

■ **Specific aspects**

- These sensors comprise 2 wires for the DC supply and a 3rd wire for the output signal.
- PNP type: switching the positive side to the load.
- NPN type: switching the negative side to the load.

■ **Advantages**

- No residual current, low voltage drop.

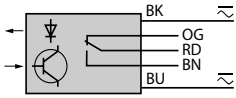

### 5-wire technique ~ or ~, relay output

■ **Specific aspects**

- Sensors incorporating output relay. The supply and output circuits are electrically separate.

■ **Advantages**

- ~ or  $\overline{\text{---}}$  supply with a wide voltage range.
- High breaking capacity (approximately 3 A).
- Direct control of a simple automation system.
- Availability of a NC (normally closed) contact and a NO (normally open) contact.
- The sensor/relay contact galvanic isolation is 1500 to 2500 V, depending on the model.

■ **Operating precautions**

- Low switching frequency. Check that it is suitable for the application.
- Limited service life of relay. Check that it is suitable for the application.

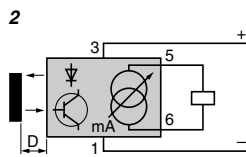
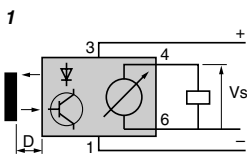

### Analogue technique

■ **Specific aspects**

There are two output configurations:

- Voltage output: the output voltage varies in proportion to the distance between the sensor and the object to be detected.
- Current output: the output current varies in proportion to the distance between the sensor and the object to be detected.

■ **Advantage**

- Availability of a physical item of data proportional to the distance between the sensor and the object to be detected.

■ **Operating precautions**

- Refer to the detailed descriptions of the sensor to assess the relative influence of the colour of the object to be detected.

- 1 Voltage output
- 2 Current output

### Outputs (continued)

### Output functions

In the past, the output functions of photo-electric sensors were always governed by the “light/dark” principle, i.e. the output would be activated on light being received for “light” switching and the output would be activated on light not being received for “dark” switching. This called for fastidious programming specific to each detection mode.













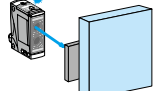

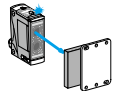

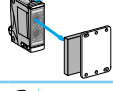

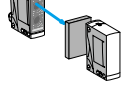

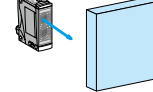

**Now, the output functions of the OsiSense XU range of photo-electric sensors are in phase with the language of the automation system engineer, i.e. NO (normally open) or NC (normally closed).**

■ **Advantages**

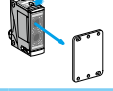
- NO output (or NO programming for multimode sensors): irrespective of the detection mode, the output of the sensor is activated when the object to be detected is present.
- NC output (or NC programming for multimode sensors): irrespective of the detection mode, the output of the sensor is activated when the object to be detected is not present.

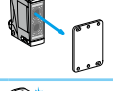
■ **Advantages of multimode sensors**

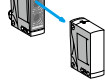
- By default, the output is NO programmed, i.e. the output of the sensor is activated when the object to be detected is present.
- By pressing the teach button, the output can programmed to NC, i.e. the output of the sensor is activated when the object to be detected is not present.

System	NO output or NO programming	Yellow LED	NC output or NC programming	Yellow LED
<b>Object present</b>				
Diffuse 	Activated	On 	Not activated	Off 
Diffuse with background suppression 	Activated	On 	Not activated	Off 
Reflex 	Activated	On 	Not activated	Off 
Polarised reflex 	Activated	On 	Not activated	Off 
Thru-beam 	Activated	On 	Not activated	Off 
<b>No object present</b>				
Diffuse 	Not activated	Off 	Activated	On 
Diffuse with background suppression 	Not activated	Off 	Activated	On 
Reflex 	Not activated	Off 	Activated	On 
Polarised reflex 	Not activated	Off 	Activated	On 
Thru-beam 	Not activated	Off 	Activated	On 

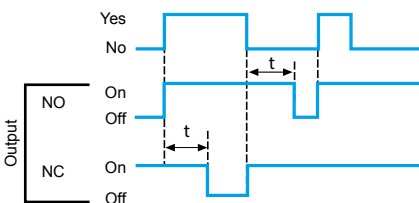

**Time delay on beam break**

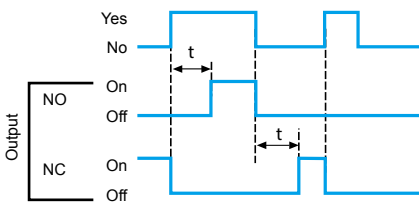

**Monostable**

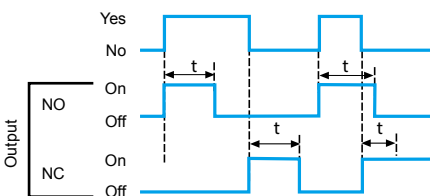

### Output signal time delay

- Certain sensor models (XUK, XUX and XUD) incorporate a time delay output.
- These time delays enable simple automation systems to be established.
- There are three types of time delay:
  - Time delay on beam make (ON delay).
  - Time delay on beam break (OFF delay).
  - Monostable (one shot).

### Connections

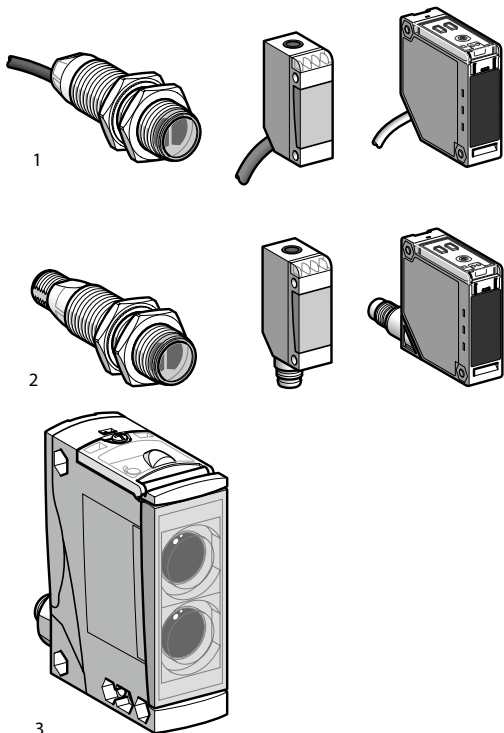

All our sensors are available either in pre-cabled version (except XUX; screw terminal with cable gland version) or connector version.

The connectors used are:

#### M12 (4-pin)



#### M8 (4-pin)



#### 1/2" 20UNF (3-pin)



#### Types of connection

- 1 Factory fitted moulded cable: good protection against splashing liquids.
- 2 Connector: easy installation and maintenance.
- 3 Screw terminals: flexibility, cable runs to required length.

#### Wiring advice

- Length of cable: no limitation up to 200 m or up to a line capacitance of <math>< 0.1 \mu\text{F}</math> (characteristics of sensors remain unaffected). In this case, it is important to take into account the voltage drop on the line.
- Separation of control and power circuit wiring: the sensors are immune to electrical interference encountered in normal industrial conditions. Where extreme conditions of electrical "noise" could occur (motors etc.), it is advisable to protect against transients in the normal way:
  - suppress interference at source and filter the power supply,
  - separate power and control wiring from each other,
  - ensure the HF equipotentiality of the site,
  - limit the length of cable,
  - connect the sensor with supply switched off.
- Dust and damp protection of connections: the level of dust and damp protection depends on how carefully the cable glands or connectors are tightened. To efficiently protect the sensors from dust and damp, select the correct diameter cable for the cable gland used.

Cable gland	Diameter of cable	
	Minimum	Maximum
9P	6	8
11P	8	10
13P	10	12
ISO 16	7	10
ISO 20	10	12

### Complementary functions

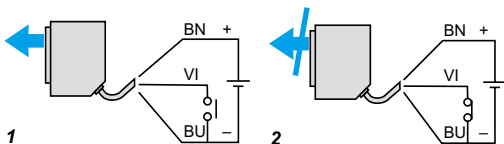

### Diagnostics, beam break test

A test input enables the transmitted beam to be broken in order to verify that the output of the sensor changes state. Fault diagnostics regarding correct operation of the sensor can therefore be carried out.

- 1 Beam made
  - 2 Beam broken
- VI: test input for breaking transmitted beam.

### Verification of correct operation

In the event of dirty lenses (reflectors), an excessively polluted atmosphere or a slight disturbance of optical alignment (mechanical impact on support), the level of light energy received by the sensor will decrease until it ceases to operate.

To overcome this problem, all our products incorporate:

- a red alarm LED,
- an alarm output, for connection in the automation system, to warn the operator that the operation of the sensor is stable but close to its limits (applies to sensors XUK, XUX, XUD).



### Specific aspects of electronic sensors

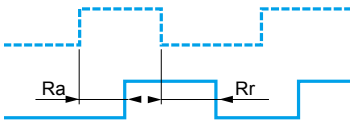
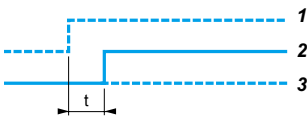
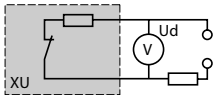
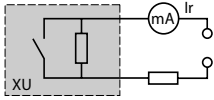

### Terminology

#### Residual current (Ir)

- The residual current (Ir) corresponds to the current flowing through the sensor when in the "open" state.
- Characteristic of 2-wire type sensors.

#### Voltage drop (Ud)

- The voltage drop (Ud) corresponds to the voltage drop at the sensor's terminals when in the "closed" state (value measured at nominal current rating of sensor).
- Characteristic of 2-wire type proximity sensors.

#### First-up delay

The first-up delay corresponds to the time (t) between the connection of the power supply to the sensor and its fully operational state.

- 1 Supply voltage U on
- 2 Sensor operational at state 1
- 3 Sensor at state 0

#### Response time

- Response time (Ra): the time delay between the object to be detected entering the sensor's operating zone and the subsequent change of output state. This parameter limits the speed and size of the object.
- Recovery time (Rr): the time delay between an object to be detected leaving the sensor's operating zone and the subsequent change of output state. This parameter limits the interval between successive objects.

### Power supplies

#### Sensors for AC circuits (~ and ~ models)

Check that the voltage limits of the sensor are compatible with the nominal voltage of the AC supply used.

#### Sensors for DC circuits (— models)

- DC source: check that the voltage limits of the sensor and the acceptable level of ripple are compatible with the supply used.
- AC source (comprising transformer, rectifier, smoothing capacitor): the supply voltage must be within the operating limits specified for the sensor.
- Where the voltage is derived from a single-phase AC supply, the voltage must be rectified and smoothed to ensure that:
  - the peak voltage of the DC supply is lower than the maximum voltage rating of the sensor.  
Peak voltage = nominal voltage  $\times \sqrt{2}$
  - the minimum voltage of the supply is greater than the minimum voltage rating of the sensor, given that:  
 $\Delta V = (I \times t) / C$   
 $\Delta V = \text{max. ripple: } 10\% (V)$   
 $I = \text{anticipated load current (mA)}$   
 $t = \text{period of 1 cycle (10 ms full-wave rectified for a 50 Hz supply frequency)}$   
 $C = \text{capacitance } (\mu F)$
- As a general rule, use a transformer with a lower secondary voltage (Ue) than the required DC voltage (U).

**Example:** ~ 18 V to obtain — 24 V, ~ 36 V to obtain — 48 V. Fit a smoothing capacitor of 400  $\mu F$  minimum per sensor, or 2000  $\mu F$  minimum per Ampere required.

### Setting-up

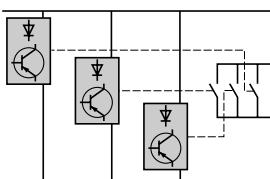
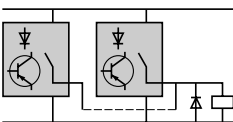
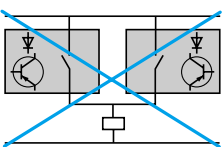
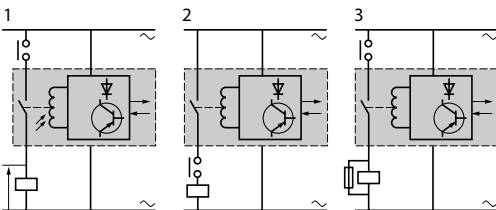
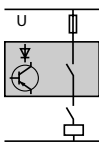
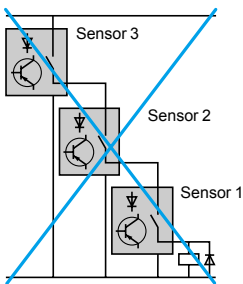
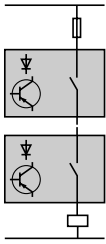

### Connection in series

#### 2-wire type sensors

■ The following points should be taken into account:

- Series wiring is only possible using sensors with wide voltage limits.

Based on the assumption that each sensor has the same residual current value, each sensor, in the open state, will share the supply voltage, i.e.

$$U_{\text{sensor}} = \frac{U_{\text{supply}}}{n \text{ sensors}}$$

U sensor and U supply must remain within the sensor's voltage limits.

- If only one sensor in the circuit is in the open state, it will be supplied at a voltage almost equal to the supply voltage.

- When in the closed state, a small voltage drop is present across each sensor. The resultant loss of voltage at the load will be the sum of the individual voltage drops and therefore, the load voltage should be selected accordingly.

#### 3-wire type sensors

**This connection method is not recommended.**

■ Correct operation of the sensors cannot be assured and, if this method is used, tests should be made before installation.

■ The following points should be taken into account:

- The first sensor carries the load current in addition to the no-load current consumption values of the other sensors connected in series. For certain models, this connection method is not possible unless a current limiting resistor is used.

- When in the closed state, a small voltage drop is present across each sensor. The load should therefore be selected accordingly.

- As sensor 1 closes, sensor 2 does not operate until a certain time (t) has elapsed (corresponding to the first-up delay) and likewise for the following sensors in the sequence.

- The use of "flywheel" diodes is recommended when an inductive load is being switched.

### Wiring sensors to devices with mechanical contact

#### 2 and 3-wire type sensors

■ The following points should be taken into account:

- When the mechanical contact is open, the sensor is not supplied.

- When the contact closes, the sensor does not operate until a certain time (t) has elapsed (corresponding to the first-up delay).

■ In scheme 1, as the external contact opens, the voltage transient caused by the breaking of the inductive load will appear inside the sensor and, if greater than the recommended max. insulation voltage, may cause a "flashover" within the sensor.

- The return path of this voltage will be back to one line of the supply, through the sensor, and should "flashover" occur anywhere on the printed circuit board, severe damage could occur.

- It is therefore recommended to use schemes 2 or 3.

### Connection in parallel

#### 2-wire type sensors

**This connection method is not recommended.**

■ Should one of the sensors be in the closed state, the sensor in parallel will be "shorted-out" and no longer supplied. As the first sensor passes into the open state, the second sensor will become energised and will be subject to its first-up delay.

■ This configuration is only permissible where the sensors will be working alternately.

■ This method of connection can lead to irreversible damage of the units.

#### 3-wire type sensors

■ No specific restrictions. The use of "flywheel" diodes is recommended when an inductive load (relay) is being switched.

### Wiring sensors to devices with mechanical contact

#### 2 and 3-wire type sensors

■ No specific restrictions.

- For these sensors, the supply and output circuits are electrically separate.

- The sensor/relay contact galvanic isolation is 1500 to 2500 V, depending on the model.

- The maximum voltage, depending on the model, across each contact is ~ 250 V.

### Setting-up precautions (continued)



### AC supply

- **2-wire type sensors cannot be connected directly to an AC supply.**
- This would result in immediate destruction of the sensor and considerable danger to the user.
- An appropriate load (refer to the instruction sheet supplied with the sensor) must always be connected in series with the sensor.

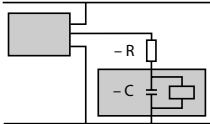

### Capacitive load ( $C > 0.1 \mu\text{F}$ )

- On power-up, it is necessary to limit (by resistor) the charging current of the capacitive load C.
- The voltage drop in the sensor can also be taken into account by subtracting it from the supply voltage for the calculation of R.

$$R = \frac{U \text{ (supply)}}{I \text{ max. (sensor)}}$$

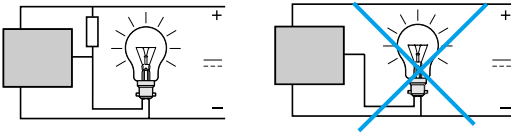

### Load comprising an incandescent lamp

- If the load comprises an incandescent lamp, the cold state resistance can be 10 times lower than the hot state resistance. This can cause very high current levels on switching. Fit a pre-heat resistor in parallel with the sensor.

$$R = \frac{U^2}{P} \times 10, \text{ U = supply voltage and P = lamp power}$$

### Fast trouble shooting guide

Problem	Possible causes	Remedy	
The sensor's output will not change state when an object enters the operating zone	On multimode sensor: setting-up error (detection mode programming)	<ul style="list-style-type: none"> <li>■ Use the detection mode display option. After a RESET, follow the environment teach mode procedure.</li> </ul>	
	Output stage faulty or complete failure of the sensor (in either case, the sensor must be replaced), or the short-circuit protection has tripped.	<ul style="list-style-type: none"> <li>■ Check that the sensor is compatible with the supply being used.</li> <li>■ Check the load current characteristics:                             <ul style="list-style-type: none"> <li>□ if load current <math>I \geq</math> maximum switching capacity, an auxiliary relay, of the CAD N type for example, should be interposed between the sensor and the load.</li> <li>□ if <math>I \leq</math> maximum switching capacity, check or wiring faults (short-circuit).</li> </ul> </li> <li>■ In all cases, a 0.4 A "quick-blow" fuse should be fitted in series with the sensor.</li> </ul>	
	Wiring error	<ul style="list-style-type: none"> <li>■ Check that the wiring conforms to the wiring shown on the sensor label or instruction sheet.</li> </ul>	
	Supply fault	<ul style="list-style-type: none"> <li>■ Check that the sensor is compatible with the supply (<math>\sim</math> or <math>\overline{\sim}</math>).</li> <li>■ Check that the supply voltage is within the voltage limits of the sensor. Remember that with a rectified, smoothed supply,</li> <li>■ (<math>U_{peak} = U_{nominal} \times \sqrt{2}</math> with a ripple voltage of <math>\leq 10\%</math>).</li> </ul>	
	With a reflex system: incorrect use or poor state of reflector	<ul style="list-style-type: none"> <li>■ The reflex system must operate in conjunction with a reflector. Adhere to the operating distances and check the alignment between the sensor and the reflector.</li> <li>■ Replace the reflector if it has been damaged.</li> <li>■ Clean the reflector and sensor lenses.</li> </ul>	
	Influence of ambient light	<ul style="list-style-type: none"> <li>■ Make sure that the sensor is not dazzled by stray light (neon, sun, oven, etc.).</li> <li>■ Fit a lens hood or turn the sensor.</li> </ul>	
	False or erratic operation, with or without the presence of an object in the operating zone	On multimode sensor: setting-up error (detection mode programming)	<ul style="list-style-type: none"> <li>■ Use the detection mode display option. After a RESET, follow the environment teach mode procedure.</li> </ul>
		Influence of background or surface condition of the object to be detected (stray reflections)	<ul style="list-style-type: none"> <li>■ Refer to the instruction sheet supplied with the sensor. For sensors with adjustable sensitivity, reduce or increase the sensing distance.</li> </ul>
Operating distance poorly defined for the reflector or object to be detected		<ul style="list-style-type: none"> <li>■ Apply the correction coefficients.</li> <li>■ Realign the system.</li> <li>■ Clean the sensor lenses and reflector, or, if damaged, replace it.</li> </ul>	
Influence of immediate environment		<ul style="list-style-type: none"> <li>■ Check the cleanliness of the lenses and reflector.</li> <li>■ Fit a lens hood, where required.</li> </ul>	
Influence of transient interference on the supply lines		<ul style="list-style-type: none"> <li>■ Ensure that any DC supplies, when derived from rectified AC, are correctly smoothed (<math>C &gt; 400 \mu F</math>).</li> <li>■ Separate AC power cables from low-level DC cables (<math>\overline{\sim}</math> 24 V low level).</li> <li>■ Where very long distances are involved, use suitable cable: screened and twisted pairs of the correct cross-sectional area.</li> </ul>	
Equipment prone to emitting electromagnetic interference		<ul style="list-style-type: none"> <li>■ Position the sensors as far away as possible from any sources of interference.</li> </ul>	
Response time of the sensor too slow for the particular object being detected		<ul style="list-style-type: none"> <li>■ Check the suitability of the sensor for the position or shape of the object to be detected.</li> <li>■ If necessary, select a sensor with a higher switching frequency.</li> </ul>	
Influence of high temperature		<ul style="list-style-type: none"> <li>■ Eliminate sources of radiated heat or protect the sensor casing with a heat shield.</li> <li>■ Realign, having adjusted the temperature around the fixing support.</li> </ul>	
Influence of ambient light	<ul style="list-style-type: none"> <li>■ Make sure that the sensor is not disrupted by a intermittent source of light (flashing light, rotating mirror beacon, hinged mirror, reflective door, etc.).</li> <li>■ Fit a lens hood or turn the sensor.</li> </ul>		

### Fast troubleshooting guide *(continued)*

Problem	Possible causes	Remedy
No detection following a period of service	Vibration, shock	<ul style="list-style-type: none"> <li>■ Realign the system</li> <li>■ Replace the support or protect the sensor.</li> </ul>
	Deterioration of relay contact	<ul style="list-style-type: none"> <li>■ On an inductive load, use an RC suppressor connected in parallel with the load.</li> <li>■ To eliminate contact contamination, the minimum current recommended is 15 mA.</li> <li>■ Relay output models are not recommended for fast counting of objects since their service life is too short. Use models with a solid-state output.</li> </ul>
	Dusty atmosphere	<ul style="list-style-type: none"> <li>■ Clean the lenses and reflector with a soft cloth.</li> </ul>

**Notes:**

- **Sensors with a test input** enable automatic verification of their correct operation.
- **Sensors with an alarm output** enable the operator to be informed, for preventive maintenance purposes, that the operating limits of sensors have been reached (dirty etc.).

# Photo-electric sensors

OsiSense XU, single mode function

Design 18, plastic

Three-wire DC, solid-state output

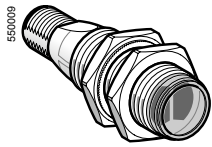

XUB●A●●NM12

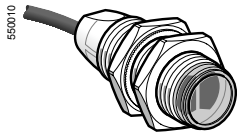

XUB●A●●NL2

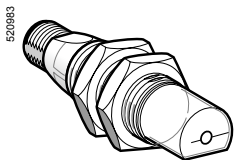

XUB●A●●WM12

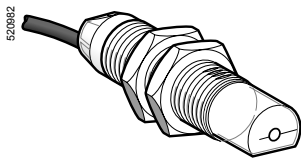

XUB●A●●WL2

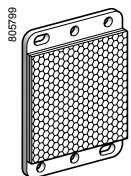

XUZC50

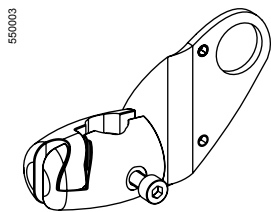

XUZA118

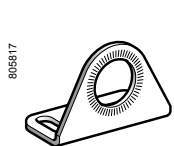

XUZA218



XUZ2001

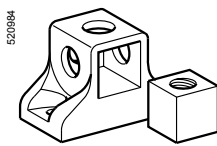

XUZ2003

## Connector

Sensing distance (Sn) m	Function	Output	Line of sight	Reference	Weight kg
<b>Diffuse system</b>					
0.1	NO	PNP	Along case axis	XUB4APANM12	0.040
			90° to case axis	XUB4APAWM12	0.040
	NPN	Along case axis	XUB4ANANM12	0.040	
		90° to case axis	XUB4ANAWM12	0.040	
	NC	PNP	Along case axis	XUB4APBNM12	0.040
			90° to case axis	XUB4APBWM12	0.040
NPN	Along case axis	XUB4ANBNM12	0.040		
	90° to case axis	XUB4ANBWM12	0.040		

## Diffuse system with adjustable sensitivity

0.6	NO	PNP	Along case axis	XUB5APANM12	0.045
			90° to case axis	XUB5APAWM12	0.050
	NPN	Along case axis	XUB5ANANM12	0.045	
		90° to case axis	XUB5ANAWM12	0.050	
	NC	PNP	Along case axis	XUB5APBNM12	0.045
			90° to case axis	XUB5APBWM12	0.050
NPN	Along case axis	XUB5ANBNM12	0.045		
	90° to case axis	XUB5ANBWM12	0.050		

## Polarised reflex system

2	NO	PNP	Along case axis	XUB9APANM12	0.040
			90° to case axis	XUB9APAWM12	0.040
	NPN	Along case axis	XUB9ANANM12	0.040	
		90° to case axis	XUB9ANAWM12	0.040	
	NC	PNP	Along case axis	XUB9APBNM12	0.040
			90° to case axis	XUB9APBWM12	0.040
NPN	Along case axis	XUB9ANBNM12	0.040		
	90° to case axis	XUB9ANBWM12	0.040		

Reflector 50 x 50 mm	–	–	–	XUZC50	0.020
----------------------	---	---	---	--------	-------

## Reflex system

4	NO	PNP	Along case axis	XUB1APANM12	0.040
			90° to case axis	XUB1APAWM12	0.040
	NPN	Along case axis	XUB1ANANM12	0.040	
		90° to case axis	XUB1ANAWM12	0.040	
	NC	PNP	Along case axis	XUB1APBNM12	0.040
			90° to case axis	XUB1APBWM12	0.040
NPN	Along case axis	XUB1ANBNM12	0.040		
	90° to case axis	XUB1ANBWM12	0.040		

Reflector 50 x 50 mm	–	–	–	XUZC50	0.020
----------------------	---	---	---	--------	-------

## Thru-beam system

Transmitter 15	–	–	Along case axis	XUB2AKSNM12T	0.040
	–	–	90° to case axis	XUB2AKSWM12T	0.040
Receiver 15	NO	PNP	Along case axis	XUB2APANM12R	0.040
			90° to case axis	XUB2APAWM12R	0.040
	NPN	Along case axis	XUB2ANANM12R	0.040	
		90° to case axis	XUB2ANAWM12R	0.040	
	NC	PNP	Along case axis	XUB2APBNM12R	0.040
			90° to case axis	XUB2APBWM12R	0.040
NPN	Along case axis	XUB2ANBNM12R	0.040		
	90° to case axis	XUB2ANBWM12R	0.040		

## Fixing accessories (1)

Description	Reference	Weight kg
3D fixing kit for use on M12 rod, for XUB or XUZC50	XUZA118	0.170
M12 rod	XUZ2001	0.050
Support for M12 rod	XUZ2003	0.150
Stainless steel fixing bracket	XUZA118	0.045
Plastic fixing bracket with adjustable ball-joint	XUZA218	0.035

## Pre-cabled

For a pre-cabled sensor, replace **M12** by **L2** for a 2 m long cable, or by **L5** for a 5 m long cable. Example: **XUB1APANM12** becomes **XUB1APANL2** for a 2 m long cable and **XUB1APANL5** for a 5 m long cable.

For availability, please consult our Customer Care Centre.

(1) For further information, see page 164.

## Characteristics

<b>Sensor type</b>		<b>XUB1, XUB2, XUB4, XUB5, XUB9</b>	<b>XUB1, XUB2, XUB4, XUB5, XUB9</b>
<b>Product certifications</b>		UL, CSA, CE	
<b>Connection</b>	Connector	M12	–
	Pre-cabled	–	Length: 2 m
<b>Sensing distance</b> nominal Sn / maximum (excess gain = 1) (excess gain = 2)	<b>m</b>	<b>0.1 / 0.15 diffuse</b>	
	<b>m</b>	<b>0.6 / 0.8 diffuse with adjustable sensitivity</b>	
	<b>m</b>	<b>2 / 3 polarised reflex</b>	
	<b>m</b>	<b>4 / 5.5 reflex</b>	
	<b>m</b>	<b>15 / 20 thru-beam</b>	
<b>Type of transmission</b>		Infrared, except polarised reflex (red)	
<b>Degree of protection</b>	Conforming to IEC 60529	IP 65, IP 67, double insulation □	
	Conforming to DIN 40050	IP 69K for connector versions	
<b>Storage temperature</b>		<b>°C</b>	- 40...+ 70
<b>Operating temperature</b>		<b>°C</b>	- 25...+ 55
<b>Materials</b>	Case	PBT	
	Lens	PMMA	
	Cable	–	PvR
<b>Vibration resistance</b>	Conforming to IEC 60068-2-6	7 gn, amplitude ± 1.5 mm (f = 10 to 55 Hz)	
<b>Shock resistance</b>	Conforming to IEC 60068-2-27	30 gn, duration 11 ms	
<b>Indicator lights</b>	Output state	Yellow LED (except for <b>XUB2●●●●●T</b> )	
	Supply on	Green LED (only for <b>XUB2●●●●●T</b> )	
<b>Rated supply voltage</b>		<b>V</b>	– 12...24 with protection against reverse polarity
<b>Voltage limits (including ripple)</b>		<b>V</b>	– 10...36
<b>Current consumption, no-load</b>		<b>mA</b>	35
<b>Switching capacity</b>		<b>mA</b>	≤ 100 with overload and short-circuit protection
<b>Voltage drop, closed state</b>		<b>V</b>	1.5
<b>Maximum switching frequency</b>		<b>Hz</b>	500
<b>Delays</b>	First-up	<b>ms</b>	< 15
	Response	<b>ms</b>	< 1
	Recovery	<b>ms</b>	< 1

## Wiring schemes

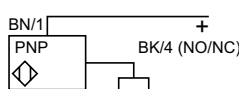
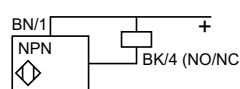
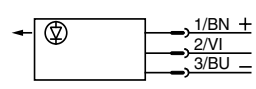
M12 connector	Pre-cabled	PNP	NPN	Transmitter
 <p>3 (-) 1 (+) 4 OUT/Output 2 Beam break input (1)</p>	<p>(-) BU (Blue) (+) BN (Brown) (OUT/Output) BK (Black) Beam break input (1) VI (Violet)</p>	 <p>BN/1 + BK/4 (NO/NC) BU/3 -</p>	 <p>BN/1 + BK/4 (NO/NC) BU/3 -</p>	 <p>1/BN + 2/VI 3/BU -</p>

Please refer to our "Cabling accessories OsiSense XZ" catalogue.

## Detection curves

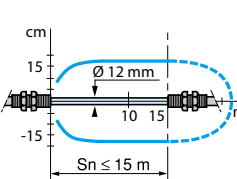
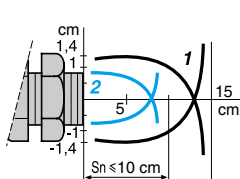
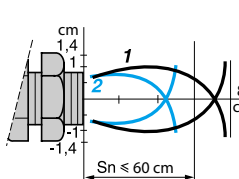
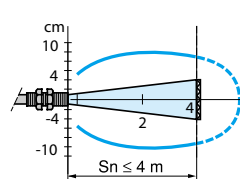
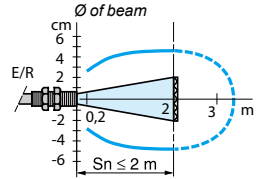
Thru-beam system	Diffuse system	Diffuse system with adjustable sensitivity	Reflex system	Polarised reflex system
 <p>∅ 12 mm Sn ≤ 15 m</p>	 <p>Sn ≤ 10 cm</p>	 <p>Sn ≤ 60 cm</p>	 <p>Sn ≤ 4 m</p>	 <p>∅ of beam Sn ≤ 2 m</p>
	Object 10 x 10 cm; 1 White 90%; 2 Grey 18%		With reflector XUZC50	With reflector XUZC50

## Dimensions

### XUB

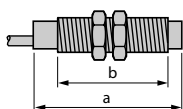

	Pre-cabled (mm)		Connector (mm)	
	a	b	a	b
∅ 18, line of sight along case axis	46 (2)	28	60 (1)	28
∅ 18, line of sight 90° to case axis	62	28	76	28
∅ 18, line of sight along case axis <b>XUB5</b>	62	44	76	44
∅ 18, line of sight 90° to case axis <b>XUB5</b>	78	44	92	44

(1) Beam break input on thru-beam transmitter only.

(2) For **XUB9●●●●●** (polarised reflex) 46 becomes 48 mm and 60 becomes 62 mm.

# Photo-electric sensors

OsiSense XU, single mode function

Design 18, metal

Three-wire DC, solid-state output

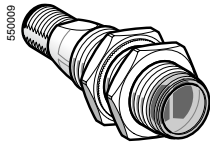

XUB●B●●NM12

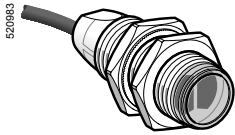

XUB●B●●NL2

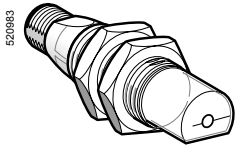

XUB●B●●WM12

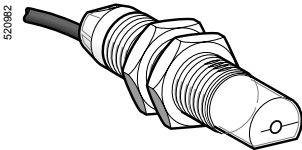

XUB●B●●WL2

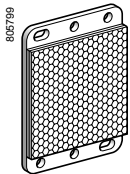

XUZC50

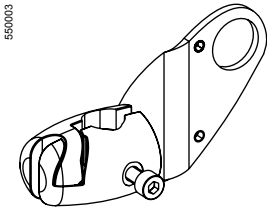

XUZB2003

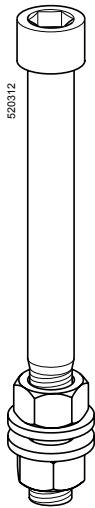

XUZ2001

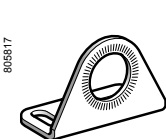

XUZA118

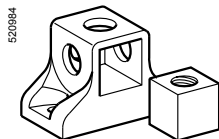

XUZA218

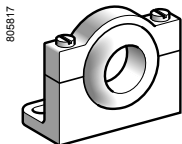

XUZA218

### Connector

Sensing distance (Sn) m	Function	Output	Line of sight	Reference	Weight kg
<b>Diffuse system</b>					
0.1	NO	PNP	Along case axis	XUB4BPANM12	0.050
			90° to case axis	XUB4BPAWM12	0.050
	NPN	PNP	Along case axis	XUB4BNANM12	0.050
			90° to case axis	XUB4BNAWM12	0.050
	NC	PNP	Along case axis	XUB4BPBWM12	0.050
			90° to case axis	XUB4BNBWM12	0.050
NPN	NPN	Along case axis	XUB4BNBNM12	0.050	
		90° to case axis	XUB4BNBW12	0.050	

### Diffuse system with adjustable sensitivity

0.6	NO	PNP	Along case axis	XUB5BPANM12	0.055
			90° to case axis	XUB5BPAWM12	0.060
	NPN	PNP	Along case axis	XUB5BNANM12	0.055
			90° to case axis	XUB5BNAWM12	0.060
	NC	PNP	Along case axis	XUB5BPBWM12	0.055
			90° to case axis	XUB5BPNM12	0.060
NPN	NPN	Along case axis	XUB5BNBNM12	0.055	
		90° to case axis	XUB5BNBW12	0.060	

### Polarised reflex system

2	NO	PNP	Along case axis	XUB9BPANM12	0.050
			90° to case axis	XUB9BPAWM12	0.050
	NPN	PNP	Along case axis	XUB9BNANM12	0.050
			90° to case axis	XUB9BNAWM12	0.050
	NC	PNP	Along case axis	XUB9BPBWM12	0.050
			90° to case axis	XUB9BPNM12	0.050
NPN	NPN	Along case axis	XUB9BNBNM12	0.050	
		90° to case axis	XUB9BNBW12	0.050	

<b>Reflector</b> 50 x 50 mm	–	–	–	XUZC50	0.020
--------------------------------	---	---	---	--------	-------

### Reflex system

4	NO	PNP	Along case axis	XUB1BPANM12	0.050
			90° to case axis	XUB1BPAWM12	0.050
	NPN	PNP	Along case axis	XUB1BNANM12	0.050
			90° to case axis	XUB1BNAWM12	0.050
	NC	PNP	Along case axis	XUB1BPBWM12	0.050
			90° to case axis	XUB1BPNM12	0.050
NPN	NPN	Along case axis	XUB1BNBNM12	0.050	
		90° to case axis	XUB1BNBW12	0.050	

<b>Reflector</b> 50 x 50 mm	–	–	–	XUZC50	0.020
--------------------------------	---	---	---	--------	-------

### Thru-beam system

<b>Transmitter</b> 15	–	–	Along case axis	XUB2BKSNM12T	0.050
			90° to case axis	XUB2BKSWM12T	0.050
<b>Receiver</b> 15	NO	PNP	Along case axis	XUB2BPANM12R	0.050
			90° to case axis	XUB2BPAWM12R	0.050
	NPN	PNP	Along case axis	XUB2BNANM12R	0.050
			90° to case axis	XUB2BNAWM12R	0.050
	NC	PNP	Along case axis	XUB2BPBWM12R	0.050
			90° to case axis	XUB2BPNM12R	0.050
NPN	NPN	Along case axis	XUB2BNBNM12R	0.050	
		90° to case axis	XUB2BNBW12R	0.050	

### Fixing accessories (1)

Description	Reference	Weight kg
3D fixing kit for use on M12 rod, for XUB or XUZC50	XUZB2003	0.170
M12 rod	XUZ2001	0.050
Support for M12 rod	XUZ2003	0.150
Stainless steel fixing bracket	XUZA118	0.045
Plastic fixing bracket with adjustable ball-joint	XUZA218	0.035

### Pre-cabled

For a pre-cabled sensor, replace **M12** by **L2** for a 2 m long cable, or by **L5** for a 5 m long cable. Example: XUB1BPANM12 becomes XUB1BPANL2 for a 2 m long cable and XUB1BPANL5 for a 5 m long cable.

For availability, please consult our Customer Care Centre.

(1) For further information, see page 164.



Characteristics		XUB1, XUB2, XUB4, XUB5, XUB9	XUB1, XUB2, XUB4, XUB5, XUB9
Sensor type		UL, CSA, CE	
Product certifications		UL, CSA, CE	
Connection	Connector	M12	-
	Pre-cabled	-	Length: 2 m
Sensing distance nominal $S_n$ / maximum (excess gain = 2) (excess gain = 1)	m	0.1 / 0.15 diffuse	
	m	0.6 / 0.8 diffuse with adjustable sensitivity	
	m	2 / 3 polarised reflex	
	m	4 / 5.5 reflex	
	m	15 / 20 thru-beam	
Type of transmission		Infrared, except polarised reflex (red)	
Degree of protection	Conforming to IEC 60529	IP 65, IP 67, double insulation $\square$	
	Conforming to DIN 40050	IP 69K for connector versions	
Storage temperature		°C - 40...+ 70	
Operating temperature		°C - 25...+ 55	
Materials	Case	Nickel plated brass	
	Lens	PMMA	
	Cable	-	PvR
Vibration resistance	Conforming to IEC 60068-2-6	7 gn, amplitude $\pm 1.5$ mm (f = 10 to 55 Hz)	
Shock resistance	Conforming to IEC 60068-2-27	30 gn, duration 11 ms	
Indicator lights	Output state	Yellow LED (except for XUB2●●●●●T)	
	Supply on	Green LED (only for XUB2●●●●●T)	
Rated supply voltage		V $\approx 12...24$ with protection against reverse polarity	
Voltage limits (including ripple)		V $\approx 10...36$	
Current consumption, no-load		mA 35	
Switching capacity		mA $\leq 100$ with overload and short-circuit protection	
Voltage drop, closed state		V 1.5	
Maximum switching frequency		Hz 500	
Delays	First-up	ms < 15	
	Response	ms < 1	
	Recovery	ms < 1	

## Wiring schemes

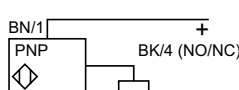
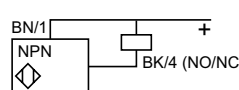
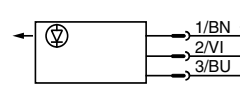
M12 connector	Pre-cabled	PNP	NPN	Transmitter
 <p>3 (-) 1 (+) 4 OUT/Output 2 Beam break input (1)</p>	<p>(-) BU (Blue) (+) BN (Brown) (OUT/Output) BK (Black) Beam break input (1) VI (Violet)</p>	 <p>BN/1 BK/4 (NO/NC) BU/3</p>	 <p>BN/1 BK/4 (NO/NC) BU/3</p>	 <p>1/BN + 2/VI 3/BU -</p>

Please refer to our "Cabling accessories OsiSense XZ" catalogue.

## Detection curves

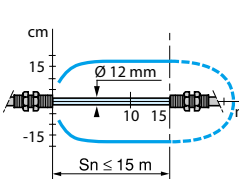
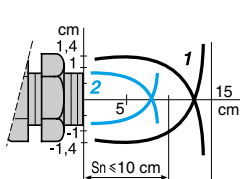
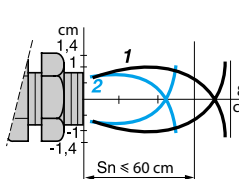
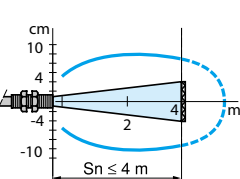
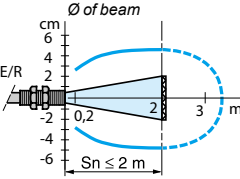
Thru-beam system	Diffuse system	Diffuse system with adjustable sensitivity	Reflex system	Polarised reflex system
 <p><math>\varnothing 12</math> mm <math>S_n \leq 15</math> m</p>	 <p><math>S_n \leq 10</math> cm</p>	 <p><math>S_n \leq 60</math> cm</p>	 <p>With reflector XUZC50 <math>S_n \leq 4</math> m</p>	 <p>With reflector XUZC50 <math>S_n \leq 2</math> m</p>

Object 10 x 10 cm; 1 White 90%; 2 Grey 18%

With reflector XUZC50

With reflector XUZC50

## Dimensions

XUB	Pre-cabled (mm)		Connector (mm)	
	a	b	a	b
$\varnothing 18$ , line of sight along case axis	46 (2)	28	60 (1)	28
$\varnothing 18$ , line of sight 90° to case axis	62	28	76	28
$\varnothing 18$ , line of sight along case axis XUB5	62	44	76	44
$\varnothing 18$ , line of sight 90° to case axis XUB5	78	44	92	44

(1) Beam break input on thru-beam transmitter only.

(2) For XUB9●●●●● (polarised reflex) 46 becomes 48 mm and 60 becomes 62 mm.

# Photo-electric sensors

OsiSense XU multimode

Design 18, metal or plastic

Three-wire DC, solid-state output

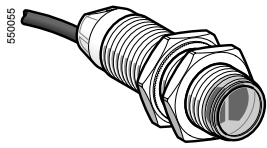

XUB0...NL2

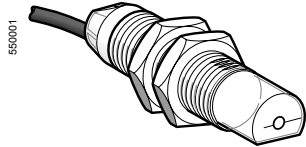

XUB0...WL2

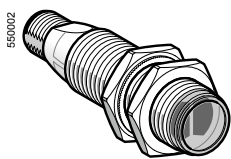

XUB0...NM12

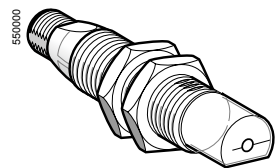

XUB0...WM12

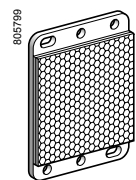

XUZC50

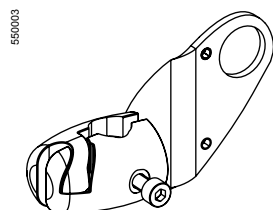

XUZB2003



XUZA118

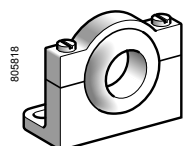

XUZA218

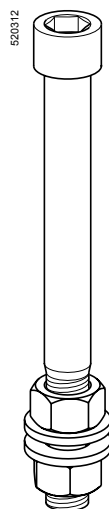

XUZ2001

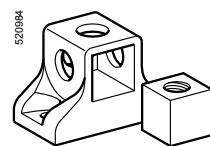

XUZ2003

## Ø 18 metal

### Pre-cabled (1)

Sensing distance (Sn) (2) m	Function	Output	Line of sight	Reference	Weight kg
0...20 depending on whether accessories are used	NO or NC, by programming	PNP	Along case axis	<b>XUB0BPSNL2</b>	0.105
			90° to case axis	<b>XUB0BPSWL2 (3)</b>	0.110
	NPN	Along case axis	<b>XUB0BNSNL2</b>	0.105	
		90° to case axis	<b>XUB0BNSWL2 (3)</b>	0.110	

### M12 connector

0...20 depending on whether accessories are used	NO or NC, by programming	PNP	Along case axis	<b>XUB0BPSNM12</b>	0.055
			90° to case axis	<b>XUB0BPSSWM12 (3)</b>	0.060
	NPN	Along case axis	<b>XUB0BNSNM12</b>	0.055	
		90° to case axis	<b>XUB0BNSWM12 (3)</b>	0.060	

### Accessories

Description	Connecti-on	Line of sight	Reference	Weight kg
Thru-beam transmitter	Pre-cabled (1)	Along case axis	<b>XUB0BKSNL2T</b>	0.105
		90° to case axis	<b>XUB0BKSWL2T (3)</b>	0.110
	M12 connector	Along case axis	<b>XUB0BKSNM12T</b>	0.055
		90° to case axis	<b>XUB0BKSWM12T (3)</b>	0.060
Reflector 50 x 50 mm	–	–	<b>XUZC50</b>	0.020

## Ø 18 plastic

### Pre-cabled (1)

Sensing distance (Sn) (3) m	Function	Output	Line of sight	Reference	Weight kg
0...20 depending on whether accessories are used	NO or NC, by programming	PNP	Along case axis	<b>XUB0APSNL2</b>	0.095
			90° to case axis	<b>XUB0APSWL2 (3)</b>	0.100
	NPN	Along case axis	<b>XUB0ANSNL2</b>	0.095	
		90° to case axis	<b>XUB0ANSWL2 (3)</b>	0.100	

### M12 connector

0...20 depending on whether accessories are used	NO or NC, by programming	PNP	Along case axis	<b>XUB0APSNM12</b>	0.045
			90° to case axis	<b>XUB0APSSWM12 (3)</b>	0.050
	NPN	Along case axis	<b>XUB0ANSNM12</b>	0.045	
		90° to case axis	<b>XUB0ANSWM12 (3)</b>	0.050	

### Accessories

Description	Connecti-on	Line of sight	Reference	Weight kg
Thru-beam transmitter	Pre-cabled (1)	Along case axis	<b>XUB0AKSNL2T</b>	0.095
		90° to case axis	<b>XUB0AKSWL2T (3)</b>	0.100
	M12 connector	Along case axis	<b>XUB0AKSNM12T</b>	0.045
		90° to case axis	<b>XUB0AKSWM12T (3)</b>	0.050
Reflector 50 x 50 mm	–	–	<b>XUZC50</b>	0.020

### Fixing accessories (4)

Description	Reference	Weight kg
3D fixing kit for use on M12 rod, for XUB or XUZC50	<b>XUZB2003</b>	0.170
M12 rod	<b>XUZ2001</b>	0.050
Support for M12 rod	<b>XUZ2003</b>	0.150
Stainless steel fixing bracket	<b>XUZA118</b>	0.045
Plastic fixing bracket with adjustable ball-joint	<b>XUZA218</b>	0.035

(1) For a 5 m long cable, replace L2 by L5.

Example: XUB0BPSNL2 becomes XUB0BPSNL5.

For availability, please consult our Customer Care Centre.

(2) For further information, see page 33.

(3) For line of sight 90° to case axis versions, see sensing distances on page 33.

(4) For further information, see page 164.

# Photo-electric sensors

OsiSense XU multimode

Design 18, metal or plastic

Three-wire DC, solid-state output

Characteristics		XUB0●●●●M12, XUB0●●●●M12T	XUB0●●●●L2, XUB0●●●●L2T
Sensor type		UL, CSA, CE	
Product certifications		UL, CSA, CE	
Connection	Connector	M12	–
	Pre-cabled	–	Length: 2 m
Sensing distance nominal Sn / (excess gain = 2)	maximum (excess gain = 1)	Line of sight along case axis	Line of sight 90° to case axis
		m	0.12 / 0.12
		m	0.3 / 0.4
		m	3 / 4
		m	20 / 30
Type of transmission		Infrared, except for polarised reflex (red)	
Degree of protection	Conforming to IEC 60529	IP 65, IP 67, double insulation	
	Conforming to DIN 40050	IP 69K for XUB0●●●●M12 and XUB0●●●●M12T	
Storage temperature	°C	- 40...+ 70	
Operating temperature	°C	- 25...+ 55	
Materials		Case: nickel plated brass for XUB0B or PBT for XUB0A; Lens: PMMA; Cable: PvR	
Vibration resistance	Conforming to IEC 60068-2-6	7 gn, amplitude ± 1.5 mm (f = 10 to 55 Hz)	
Shock resistance	Conforming to IEC 60068-2-27	30 gn, duration 11 ms	
Indicator lights	Output state	Yellow LED (transmission present for XUB0●●●●●T)	
	Supply on	Green LED	
	Optical alignment aid/dirty	Red LED (except for XUB0●●●●●T)	
Rated supply voltage	V	12...24 with protection against reverse polarity	
Voltage limits (including ripple)	V	10...36	
Current consumption, no-load	mA	35 (20 for XUB0●●●●●T)	
Switching capacity	mA	≤ 100 with overload and short-circuit protection	
Voltage drop, closed state	V	< 1.5	
Maximum switching frequency	Hz	250 (200 for diffuse with background suppression)	
Delays	First-up	ms	< 200
	Response	ms	< 2 (< 2.5 for diffuse with background suppression)
	Recovery	ms	< 2 (< 2.5 for diffuse with background suppression)

## Wiring schemes

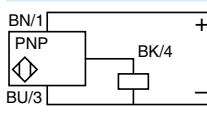
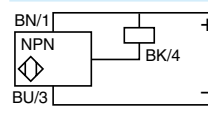
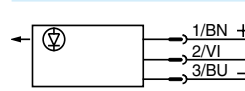
M12 connector	Pre-cabled	Receiver, PNP output	Receiver, NPN output	Thru-beam transmitter
 <p>3 (-) 1 (+) 4 OUT/Output 2 Beam break input (1)</p>	<p>(-) BU (Blue) (+) BN (Brown) OUT/Output BK (Black) Beam break input (1) VI (Violet)</p>	 <p>BN/1 + BU/3 - BK/4</p>	 <p>BN/1 + BU/3 - BK/4</p>	 <p>1/BN + 2/VI - 3/BU -</p> <p>Input 2/VI: - not connected: beam made - connected to -: beam broken</p>

## Detection curves (line of sight along case axis)

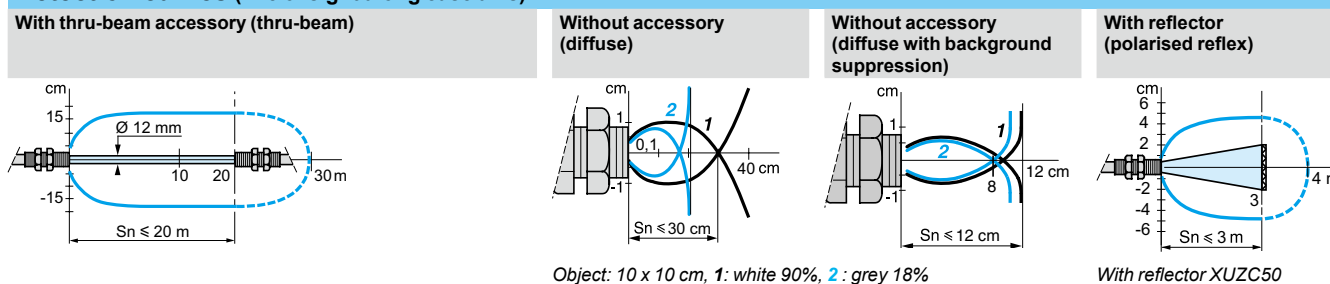

## Variation of usable sensing distance Su (without accessory, with adjustable background suppression)

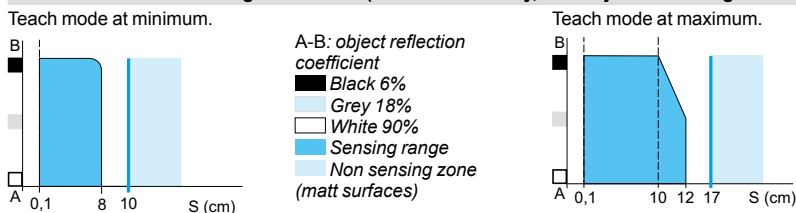

## Dimensions

XUB	Pre-cabled (mm)		Connector (mm)	
	a	b	a	b
Ø 18, line of sight along case axis	64 (2)	44	78 (2)	44
Ø 18, line of sight 90° to case axis	78	44	92	44

(1) Beam break input on thru-beam transmitter only.

(2) For XUB0●●●●●T, 64 becomes 62 mm and 78 becomes 76 mm.

# Photo-electric sensors

OsiSense XU, general purpose, single mode function

Miniature design, plastic

Three-wire DC, solid-state output

NO/NC configuration switch

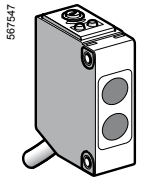

XUM5A●CNL2

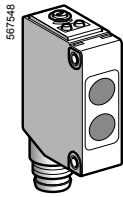

XUM5A●CNM8

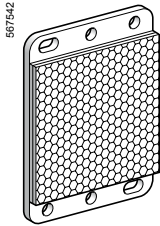

XUZC50

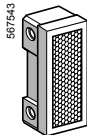

XUZC08

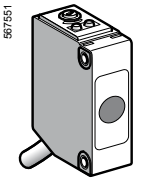

XUM2AKCNL2T

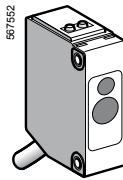

XUM2A●CNL2R

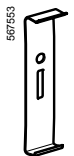

XUZMSV●●

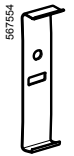

XUZMSH●●

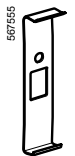

XUZMU01

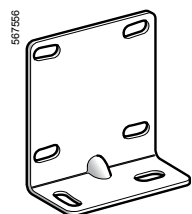

XUZAM01

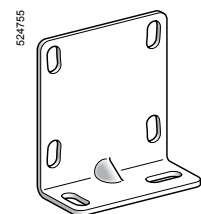

XUZAM04

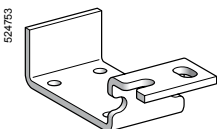

XUZAM03

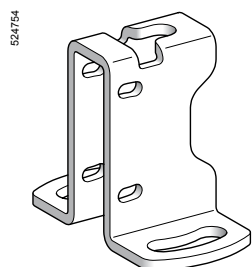

XUZAM02

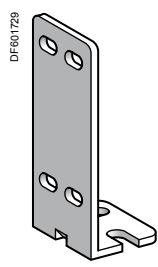

XUZA50

Sensing distance (Sn)	Function	Output	Connection	Reference	Weight kg
<b>Diffuse system with adjustable sensitivity</b>					
1 m	NO/NC, configuration by switch	PNP	Pre-cabled (L = 2 m) M8 connector	XUM5APCNL2 XUM5APCNM8	0.063 0.010
		NPN	Pre-cabled (L = 2 m) M8 connector	XUM5ANCNL2 XUM5ANCNM8	0.063 0.010

Sensing distance	Function	Output	Connection	Reference	Weight kg
<b>Polarised reflex system with adjustable sensitivity</b>					
5 m with reflector XUZC50	NO/NC, configuration by switch	PNP	Pre-cabled (L = 2 m) M8 connector	XUM9APCNL2 XUM9APCNM8	0.063 0.010
2 m with reflector XUZC08			NPN	Pre-cabled (L = 2 m) M8 connector	XUM9ANCNL2 XUM9ANCNM8

Reflectors			Reference	Weight kg
Universal reflector 50 x 50 mm	-	-	XUZC50	0.020
Lateral reflector 8.6 x 29.5 mm	-	-	XUZC08	0.006

Sensing distance	Function	Output	Connection	Reference	Weight kg
<b>Thru-beam system (transmitter + receiver) with adjustable sensitivity</b>					
15 m	NO/NC, configuration by switch	PNP	Pre-cabled (L = 2 m) M8 connector	XUM2APCNL2 XUM2APCNM8	0.119 0.019
			NPN	Pre-cabled (L = 2 m) M8 connector	XUM2ANCNL2 XUM2ANCNM8

Transmitter only			Reference	Weight kg	
15 m			Pre-cabled (L = 2 m) M8 connector	XUM2AKCNL2T XUM2AKCNM8T	0.063 0.010

Receiver only				Reference	Weight kg
15 m	NO/NC, configuration by switch	PNP	Pre-cabled (L = 2 m) M8 connector	XUM2APCNL2R XUM2APCNM8R	0.063 0.010
			NPN	Pre-cabled (L = 2 m) M8 connector	XUM2ANCNL2R XUM2ANCNM8R

<b>Accessories for thru-beam system</b>					
Description	Dimensions mm	Sensing distance m	Reference	Weight kg	
Vertical diaphragm <i>Sold in lots of 2</i>	0.5 x 6.4	1.2	XUZMSV05	0.002	
	1 x 6.4	3	XUZMSV10	0.002	
	1.5 x 6.4	4	XUZMSV15	0.002	
	2 x 6.4	5	XUZMSV20	0.002	
Horizontal diaphragm <i>Sold in lots of 2</i>	0.5 x 6.4	1.2	XUZMSH05	0.002	
	1 x 6.4	3	XUZMSH10	0.002	
	1.5 x 6.4	4	XUZMSH15	0.002	
	2 x 6.4	5	XUZMSH20	0.002	
Anti-interference filter <i>Sold in lots of 4</i>	-	7	XUZMU01	0.006	

<b>Fixing accessories</b>		
Description	Reference	Weight kg
Base mounting fixing bracket	XUZAM01	0.017
Side mounting fixing bracket	XUZAM04	0.026
Vertical fixing bracket with protective cover (1)	XUZAM02	0.062
Horizontal fixing bracket with protective cover (1)	XUZAM03	0.026
Metal fixing bracket	XUZA50	0.025

(1) For pre-cabled version

# Photo-electric sensors

OsiSense XU, general purpose, single mode function

Miniature design, plastic

Three-wire DC, solid-state output

NO/NC configuration switch

## Characteristics

Sensor type		XUM●A●●●M8	XUM●A●●●L2
Product certifications		CE, cULus, CTick	
Connection	Connector	M8	–
	Pre-cabled	–	Length: 2 m
Nominal sensing distance $S_n$ (excess gain = 2)	m	<b>1 diffuse with adjustable sensitivity</b>	
	m	<b>5 polarised reflex with adjustable sensitivity</b>	
	m	<b>15 thru-beam with adjustable sensitivity</b>	
Type of transmission		Red, except diffuse system (Infrared)	
Degree of protection	Conforming to IEC 60529	IP 65, IP 67	
Storage temperature		°C - 40...+ 70	
Operating temperature		°C - 30...+ 60	
Materials	Case	PBT	
	Lens	PMMA	
	Cable	–	PVC (black for transmitter, grey for other versions)
Vibration resistance	Conforming to IEC 60068-2-6	10 to 55 Hz, amplitude $\pm 1.5$ mm, 2 hours in each direction X, Y and Z	
Shock resistance	Conforming to IEC 60068-2-27	500 m/s <sup>2</sup> 10 x in each direction X, Y and Z	
Indicator lights	Output state	Orange LED (excluding transmitter)	
	Stability	Green LED	
	Transmitter	Orange LED: supply on	
	Receiver	Red LED: light received; green LED: supply on	
Rated supply voltage		V --- 12...24 with protection against reverse polarity	
Voltage limits (including ripple)		V --- 10...30	
Current consumption, no-load		mA 16 for XUM5; 13 for XUM9; 11 for transmitter XUM2; 13 for receiver XUM2	
Switching capacity		mA $\leq 100$ with overload and short-circuit protection	
Voltage drop, closed state		V $\leq 3$	
Maximum switching frequency		Hz 1000	
Delays	First-up	ms < 100	
	Response	ms 0.5	
	Recovery	ms 0.5	

## Wiring schemes

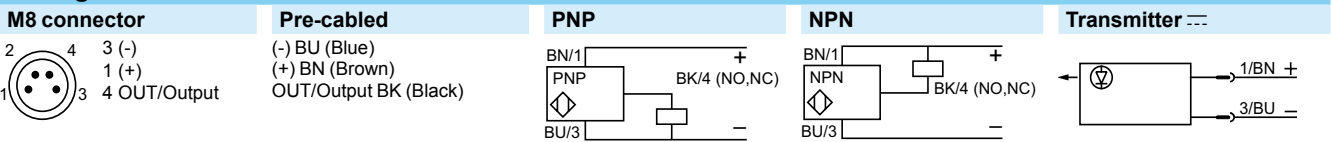

## Curves

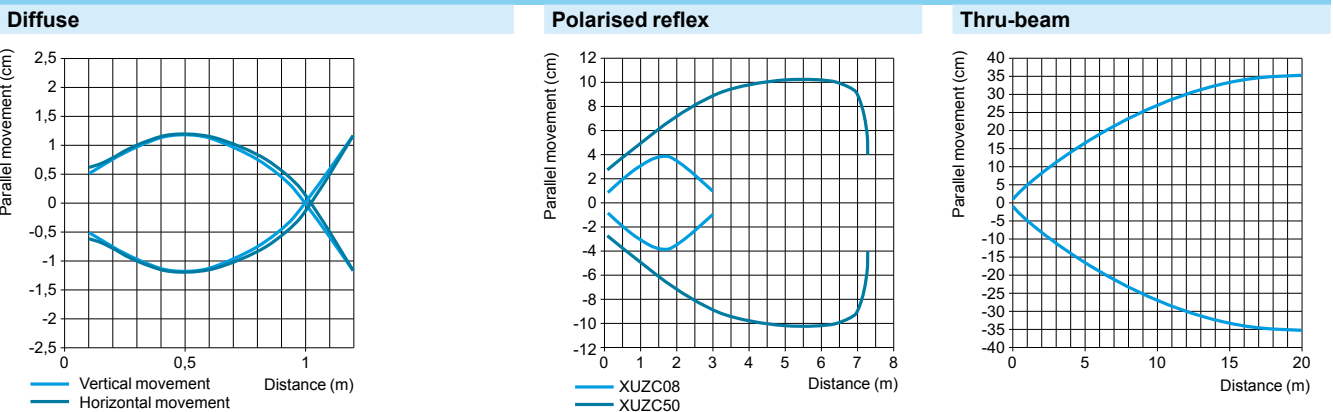

# Photo-electric sensors

OsiSense XU, general purpose, single mode function

Miniature design, plastic

Three-wire DC, solid-state output

NO/NC configuration switch

## Diffuse system, polarised reflex system

### Pre-cabled version

Description - XUM5A●CNL2, XUM9A●CNL2

Dimensions - XUM5A●CNL2, XUM9A●CNL2

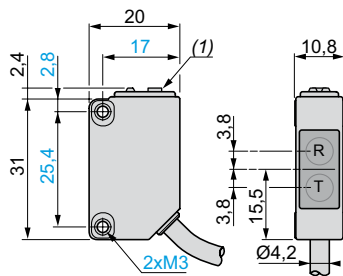
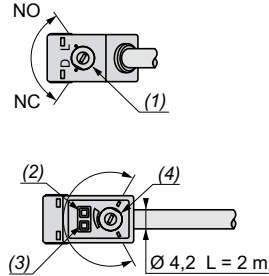

- (1) Configuration switch.
- (2) Output state LED.
- (3) Stability and power on LED.
- (4) Adjustment potentiometer.

R: Reception, T: Transmission.  
(1) Potentiometer.

### Connector version

Description - XUM5A●CNM8, XUM9A●CNM8

Dimensions - XUM5A●CNM8, XUM9A●CNM8

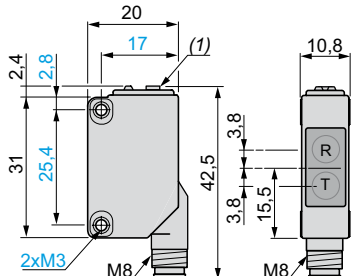
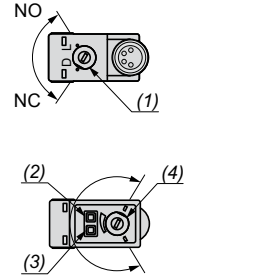

- (1) Configuration switch.
- (2) Output state LED.
- (3) Stability and power on LED.
- (4) Adjustment potentiometer.

R: Reception, T: Transmission.  
(1) Potentiometer.

## Thru-beam system

### Pre-cabled version

Description - XUM2AKCNL2T

Dimensions - XUM2AKCNL2T

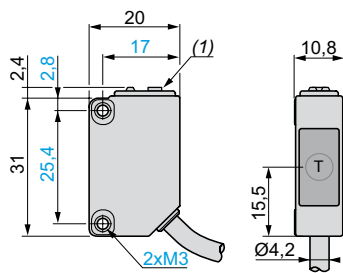
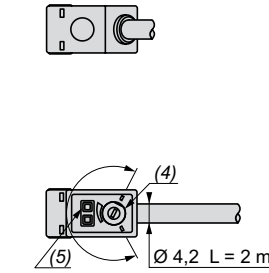

- (4) Adjustment potentiometer.
- (5) Power on LED.

T: Transmission.  
(1) Potentiometer.

Description - XUM2A●CNL2R

Dimensions - XUM2A●CNL2R

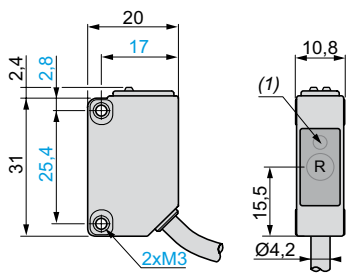
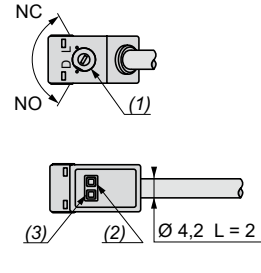

- (1) Configuration switch.
- (2) Output state LED.
- (3) Stability and power on LED.

R: Reception.  
(1) Output state LED on front face.

### Connector version

Description - XUM2AKCNM8T

Dimensions - XUM2AKCNM8T

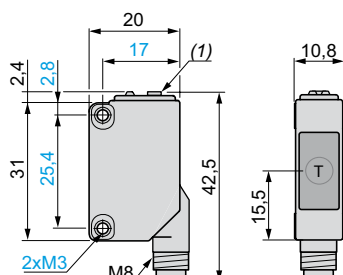
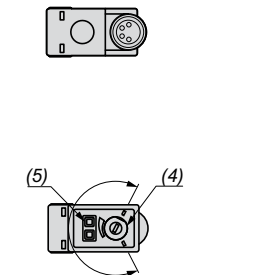

- (4) Adjustment potentiometer.
- (5) Power on LED.

T: Transmission.  
(1) Potentiometer.

Description - XUM2A●CNM8R

Dimensions - XUM2A●CNM8R

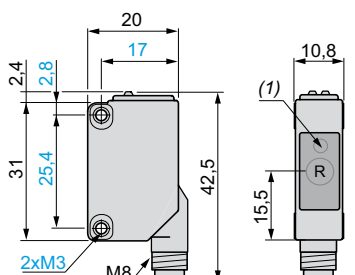
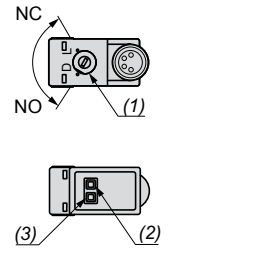

- (1) Configuration switch.
- (2) Output state LED.
- (3) Stability and power on LED.

R: Reception.  
(1) Output state LED on front face.

## Accessories

### Diaphragms

XUZMSV●●

XUZMSH●●

XUZ a

### Filter

XUZMU01

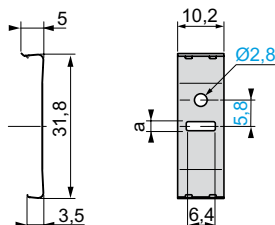
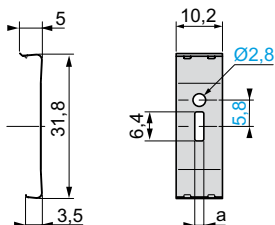

XUZ	a
MSV05	0.5
MSV10	1
MSV15	1.5
MSV20	2
MSH05	0.5
MSH10	1
MSH15	1.5
MSH20	2

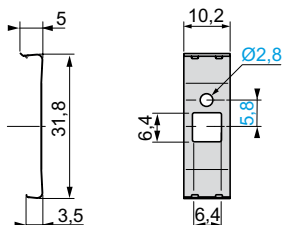

# Photo-electric sensors

OsiSense XU, general purpose, single mode function

Miniature design, plastic

Three-wire DC, solid-state output

NO/NC configuration switch

## Accessories

### Reflectors

#### XUZC50

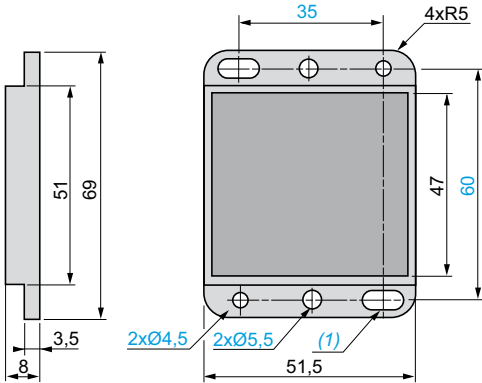

(1) 2 elongated holes Ø 4.5 x 8

#### XUZC08

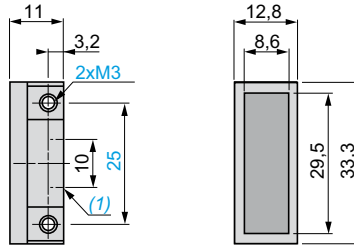

(1) 2 x M3

### Fixing brackets

#### XUZAM04

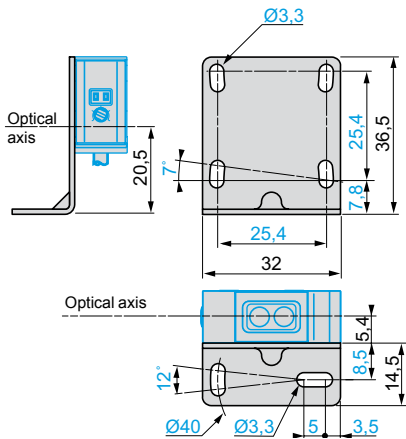

#### XUZAM01

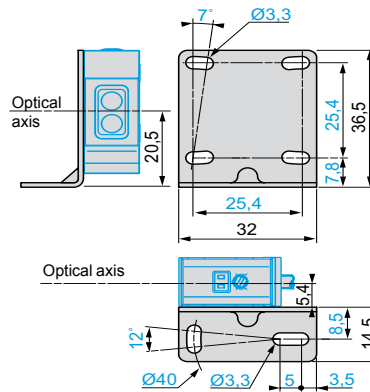

#### XUZA50

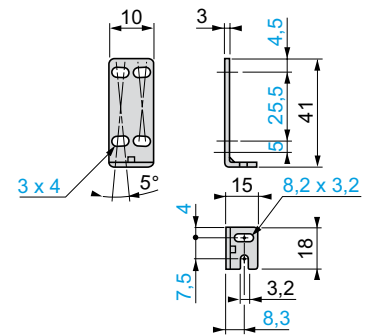

### Fixing bracket with protective cover

#### XUZAM03

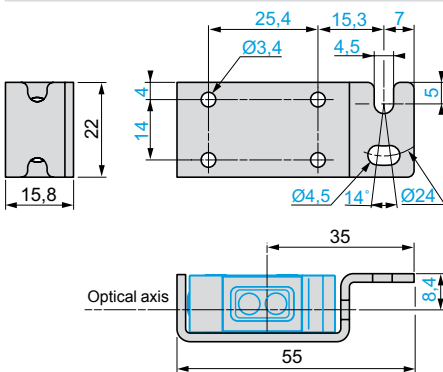

#### XUZAM02

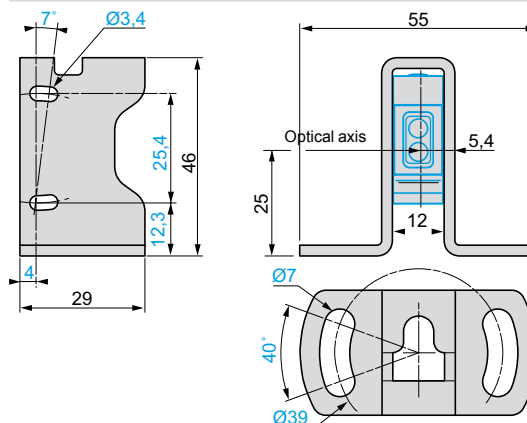

# Photo-electric sensors

OsiSense XU, general purpose

Multimode function

Miniature design

Three-wire DC, solid-state output

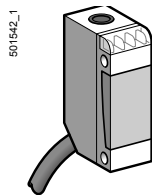

XUM0A●●●L2

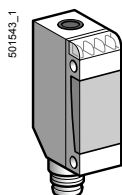

XUM0A●●●M8

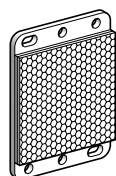

XUZC50

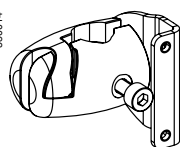

XUZM2003

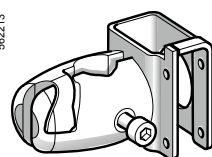

XUZM2004

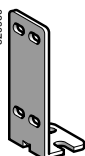

XUZA50

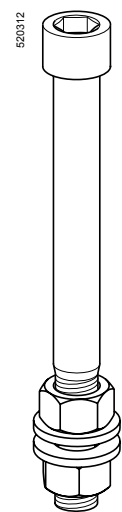

XUZ2001

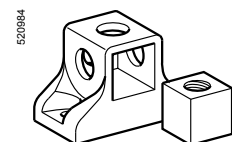

XUZ2003

## Miniature design, DC

Sensing distance (Sn) m	Function	Output	Connection	Reference	Weight kg
0...10 depending on whether accessories are used	NO or NC, by programming	PNP	Pre-cabled (L = 2 m) (1)	XUM0APSAL2	0.050
			M8 connector	XUM0APSAM8	0.035
		NPN	Pre-cabled (L = 2 m) (1)	XUM0ANSAL2	0.050
			M8 connector	XUM0ANSAM8	0.035

## Accessories

Description	Connection	Reference	Weight kg
Thru-beam transmitter	Pre-cabled (L = 2 m) (1)	XUM0AKSAL2T	0.050
	M8 connector	XUM0AKSAM8T	0.035
Reflector 50 x 50 mm	–	XUZC50	0.020

## Fixing accessories (2)

Description	Reference	Weight kg
3D fixing kit for use on M12 rod, for XUM or XUZC50	XUZM2003	0.140
3D fixing kit for use on M12 rod and with protective cover for XUM	XUZM2004	0.155
M12 rod	XUZ2001	0.050
Support for M12 rod	XUZ2003	0.150
Fixing bracket	XUZA50	0.025

(1) For a 5 m long cable, replace L2 by L5.  
Example: XUM0APSAL2 becomes XUM0APSAL5.  
(2) For further information, see page 164.

## Dimensions (mm)

### XUM0A●●●L2

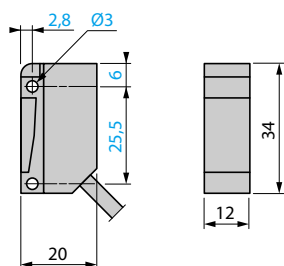

### XUM0A●●●M8

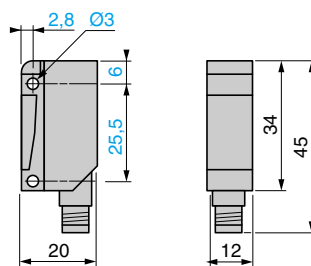

Possible orientation of elbowed connector

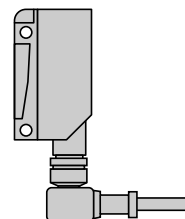



Characteristics		XUM●●●●●M8	XUM●●●●●L2
Sensor type		UL, CSA, CE	
Product certifications		UL, CSA, CE	
Connection	Connector	M8	-
	Pre-cabled	-	Length: 2 m
Nominal sensing distance $S_n$ (excess gain = 2)	m	0.11 / 0.11 without accessory (diffuse with background suppression)	
	m	0.4 / 0.55 without accessory (diffuse)	
	m	3 / 4 with reflector (polarised reflex)	
	m	10 / 14 with transmitter for thru-beam function (thru-beam)	
Type of transmission		Infrared, except polarised reflex (red)	
Degree of protection	Conforming to IEC 60529	IP 65, IP 67	IP 65, IP 67, double insulation □
Storage temperature		°C -40...+70	
Operating temperature		°C -25...+55	
Materials	Case	PBT	
	Lens	PMMA	
	Cable	-	PvR
Vibration resistance	Conforming to IEC 60068-2-6	7 gn, amplitude ± 1.5 mm (f = 10 to 55 Hz)	
Shock resistance	Conforming to IEC 60068-2-27	30 gn, duration 11 ms	
Indicator lights	Output state	Yellow LED (transmission present for XUM0●●●●●T)	
	Supply on	Green LED	
	Optical alignment aid/dirty	Red LED (except for XUM0●●●●●T)	
Rated supply voltage		V --- 12...24 with protection against reverse polarity	
Voltage limits (including ripple)		V --- 10...30	
Current consumption, no-load		mA 35 (20 for XUM0●●●●●T)	
Switching capacity		mA ≤ 100 with overload and short-circuit protection	
Voltage drop, closed state		V ≤ 1.5	
Maximum switching frequency		Hz 250 (200 for diffuse with background suppression)	
Delays	First-up	ms < 200	
	Response	ms < 2 (< 2.5 for diffuse with background suppression)	
	Recovery	ms < 2 (< 2.5 for diffuse with background suppression)	

**Wiring schemes**

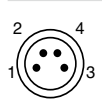
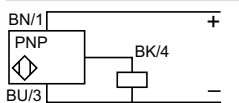
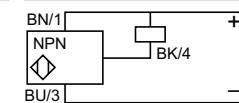
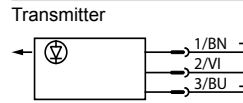
M8 connector	Pre-cabled	Receiver, PNP output	Receiver, NPN output	Thru-beam function transmitter
 <p>3 (-) 1 (+) 4 OUT/Output 2 Beam break input (1)</p>	<p>(-) BU (Blue) (+) BN (Brown) OUT/Output BK (Black) Beam break input VI (Violet) (1)</p>	 <p>BN/1 + BK/4 BU/3 -</p>	 <p>BN/1 + BK/4 BU/3 -</p>	 <p>1/BN + 2/VI + 3/BU =</p> <p>Input 2/VI: - not connected: beam made - connected to -: beam broken</p>

**Detection curves**

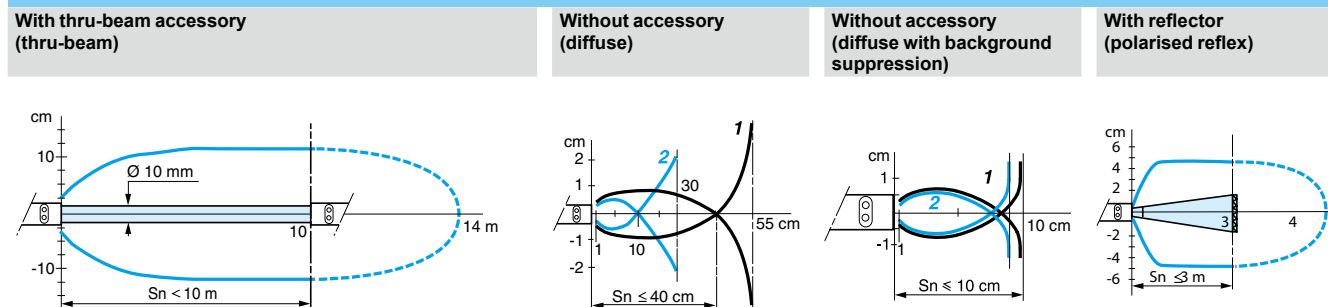

Object: 10 x 10 cm, 1: white 90%, 2: grey 18%

**Variation of usable sensing distance  $S_u$  (without accessory, with adjustable background suppression)**

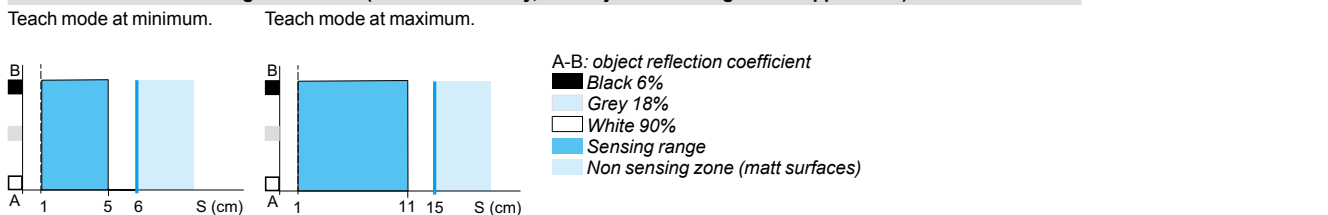

(1) Beam break input on thru-beam transmitter only.



# Photo-electric sensors

OsiSense XU, general purpose

With adjustable background and foreground suppression

suppression

DC supply. Solid-state output

## Detection curves

Adjustment ranges in background or foreground suppression mode

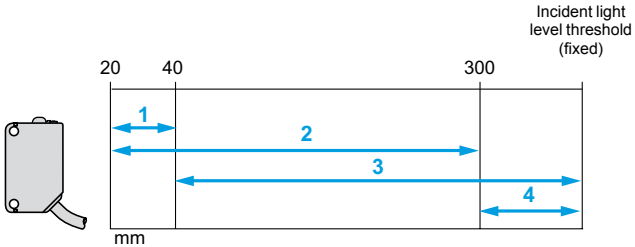

- 1 Background suppression (on minimum setting)
- 2 Background suppression (on maximum setting)
- 3 Foreground suppression (on minimum setting)
- 4 Foreground suppression (on maximum setting)

Adjustment in background or foreground suppression mode

Cabling of pink wire determines the detection mode:

- Background detection mode, pink wire not connected to 0 V (blue wire)
- Foreground detection mode, pink wire connected to +V (brown wire)

Function	Cabling	Application
Background suppression	Pink wire to 0 V	To detect the object when it is detached from the background.
Foreground suppression	Pink wire to +V	To detect the object when it is in contact with the background or to suppress a foreground.

## Dimensions

XUM8APCNL2, XUM8ANCNL2 and XUM8APCNL03M12

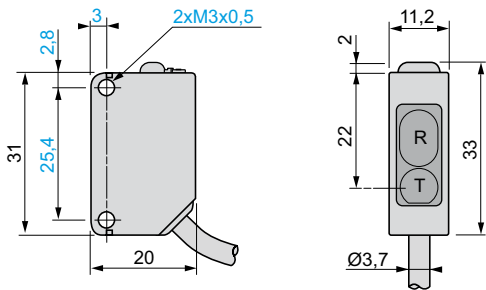

R: Reception, T: Transmission

XUM8APCNM8 and XUM8ANCNM8

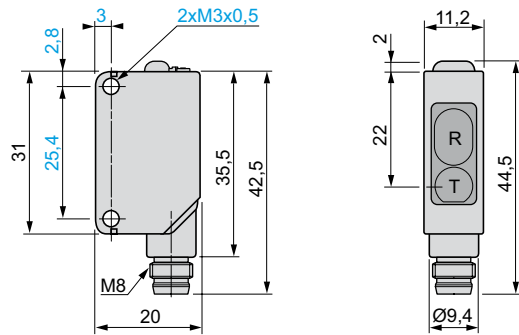

## Mounting

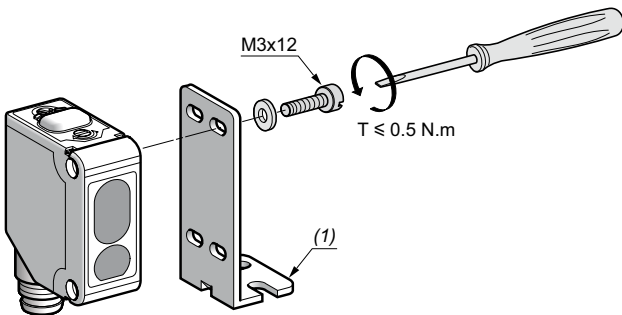

(1) XUZA50, XUZAM02 or XUZAM03 metal bracket (see page 34).

## Functions

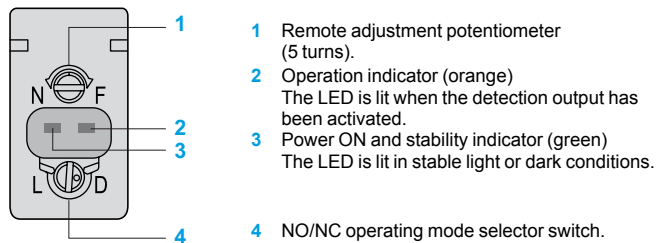

Selector switch	Function	Description
	NO (position L)	The NO output is activated when the selector switch is turned fully clockwise.
	NC (position D)	The NC output is activated when the selector switch is turned fully anticlockwise.

## Wiring schemes (3-wire ---)

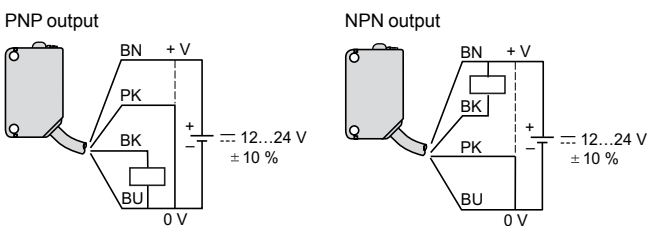

**Note:** These schemes are represented in "background suppression" mode, cabling of pink (PK) wire to 0 V.

## Cable connections

XUM8A●CNL2

- (-) BU (Blue)
- (+) BN (Brown)
- (OUT) BK (Black)
- (MODE) PK (Pink)

## Connector schemes

XUM8A●CNM8

- M8 connector
- 
- 2 4 3 (-)
  - 1 (+)
  - 4 Output
  - 2 Mode/Input

XUM8APCNL03M12

- M12 connector
- 
- 4 3 3 (-)
  - 1 (+)
  - 4 Output
  - 2 Mode/Input

Please refer to our "Cabling accessories OsiSense XZ" catalogue.

# Photo-electric sensors

OsiSense XU, general purpose, single mode function  
 Compact design, 50 x 50  
 Five-wire AC or DC, 1 CO relay output  
 Three-wire DC, solid-state output

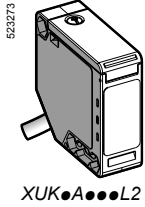

XUK●A●●●L2

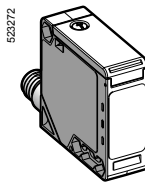

XUK●A●●●M12

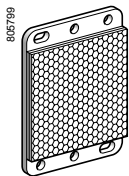

XUZC50

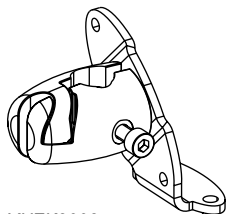

XUZK2003

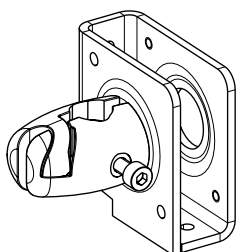

XUZK2004

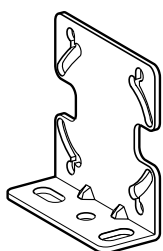

XUZA51

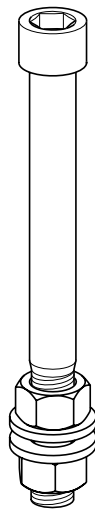

XUZ2001

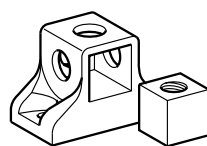

XUZ2003

Sensing distance (Sn) m	Function	Output	Connection	Reference	Weight kg	
<b>Diffuse system with adjustable sensitivity</b>						
<b>DC</b>						
1	NO	PNP	Pre-cabled (L = 2 m) (1) M12 connector	XUK5APANL2 XUK5APANM12	0.190 0.070	
		NPN	Pre-cabled (L = 2 m) (1) M12 connector	XUK5ANANL2 XUK5ANANM12	0.190 0.070	
	NC	PNP	Pre-cabled (L = 2 m) (1) M12 connector	XUK5APBNL2 XUK5APBNM12	0.190 0.070	
		NPN	Pre-cabled (L = 2 m) (1) M12 connector	XUK5ANBNL2 XUK5ANBNM12	0.190 0.070	
	<b>AC or DC</b>					
	1	NO + NC	Relay	Pre-cabled (L = 2 m) (1)	XUK5ARCNL2	0.190
<b>Polarised reflex system</b>						
<b>DC</b>						
6	NO	PNP	Pre-cabled (L = 2 m) (1) M12 connector	XUK9APANL2 XUK9APANM12	0.190 0.070	
		NPN	Pre-cabled (L = 2 m) (1) M12 connector	XUK9ANANL2 XUK9ANANM12	0.190 0.070	
	NC	PNP	Pre-cabled (L = 2 m) (1) M12 connector	XUK9APBNL2 XUK9APBNM12	0.190 0.070	
		NPN	Pre-cabled (L = 2 m) (1) M12 connector	XUK9ANBNL2 XUK9ANBNM12	0.190 0.070	
	<b>DC or AC</b>					
	6	NO + NC	Relay	Pre-cabled (L = 2 m) (1)	XUK9ARCNL2	0.190
	Reflector 50 x 50 mm (2)	-	-	XUZC50	0.020	
<b>Reflex system</b>						
<b>DC</b>						
7	NO	PNP	Pre-cabled (L = 2 m) (1) M12 connector	XUK1APANL2 XUK1APANM12	0.070 0.070	
		NPN	Pre-cabled (L = 2 m) (1) M12 connector	XUK1ANANL2 XUK1ANANM12	0.070 0.070	
	NC	PNP	Pre-cabled (L = 2 m) (1) M12 connector	XUK1APBNL2 XUK1APBNM12	0.070 0.070	
		NPN	Pre-cabled (L = 2 m) (1) M12 connector	XUK1ANBNL2 XUK1ANBNM12	0.070 0.070	
	<b>AC or DC</b>					
	7	NO + NC	Relay	Pre-cabled (L = 2 m) (1)	XUK1ARCNL2	0.175
	Reflector 50 x 50 mm (2)	-	-	XUZC50	0.020	
<b>Thru-beam system</b>						
<b>DC</b>						
Transmitter 30	-	-	Pre-cabled (L = 2 m) (1) M12 connector	XUK2AKSNL2T XUK2AKSNM12T	0.190 0.070	
	Receiver 30	NO	PNP	Pre-cabled (L = 2 m) (1) M12 connector	XUK2APANL2R XUK2APANM12R	0.140 0.075
NPN			Pre-cabled (L = 2 m) (1) M12 connector	XUK2ANANL2R XUK2ANANM12R	0.140 0.075	
NC		PNP	Pre-cabled (L = 2 m) (1) M12 connector	XUK2APBNL2R XUK2APBNM12R	0.140 0.075	
		NPN	Pre-cabled (L = 2 m) (1) M12 connector	XUK2ANBNL2R XUK2ANBNM12R	0.140 0.075	
<b>AC or DC</b>						
Transmitter, 30	-	-	Pre-cabled (L = 2 m) (1)	XUK2ARCNL2T	0.140	
Receiver, 30	NO + NC	Relay	Pre-cabled (L = 2 m) (1)	XUK2ARCNL2R	0.070	
<b>Fixing accessories (2)</b>						
Description				Reference	Weight kg	
3D fixing kit for use on M12 rod, for XUK or XUZC50				XUZK2003	0.170	
3D fixing kit for use on M12 rod, with protective cover for XUK				XUZK2004	0.270	
M12 rod				XUZ2001	0.050	
Support for M12 rod				XUZ2003	0.150	
Fixing bracket				XUZA51	0.050	

(1) For a 5 m long cable replace L2 by L5; for a 10 m long cable replace L2 by L10. Example: XUK5APANL2 becomes XUK5APANL5 or XUK5APANL10.

For availability, please consult our Customer Care Centre.

(2) For further information, see page 164.

# Photo-electric sensors

OsiSense XU, general purpose, single mode function

Compact design, 50 x 50

Five-wire AC or DC, 1 CO relay output

Three-wire DC, solid-state output

## Characteristics

		XUK●●●●M12	XUK●●●●L2
Sensor type			
Product certifications		UL, CSA, CE	
Connection		M12 connector	Pre-cabled, length: 2 m
Sensing distance		PNP/NPN or relay output 1 / 1.5 diffuse	
nominal Sn / maximum	m	PNP/NPN or relay output 6 / 8 polarised reflex	
(excess gain = 2) (excess gain = 1)	m	PNP/NPN or relay output 7 / 10 reflex	
		PNP/NPN or relay output 30 / 45 thru-beam	
Type of transmission		Infrared, except polarised reflex (red)	
Degree of protection	Conforming to IEC 60529	IP 65, double insulation □	
Storage temperature	°C	- 40...+ 70	
Operating temperature	°C	- 25...+ 55	
Materials		Case: PBT	
	Lens	PMMA	
	Cable	-	
			PVC
Vibration resistance	Conforming to IEC 60068-2-6	7 gn, amplitude ± 1.5 mm (f = 10 to 55 Hz)	
Shock resistance	Conforming to IEC 60068-2-27	30 gn, duration 11 ms	
Indicator lights		Output state: Yellow LED (except for XUK2●●●●●T)	
		Supply on: Green LED (only for XUK2●●●●●T)	
Rated supply voltage		PNP/NPN: V	12...24 with protection against reverse polarity
		Relay output: V	-
			≈ 24...240
Voltage limits (including ripple)		PNP/NPN: V	--- 10...36
		Relay output: V	-
			≈ 20...264
Current consumption, no-load		PNP/NPN: mA	≤ 35
Power consumption		Relay output: W	-
			≈ 2
Switching capacity		PNP/NPN: mA	≤ 100 with overload and short-circuit protection
		Relay output: A	-
			≈ 3
Voltage drop, closed state		V	≤ 1.5
Maximum switching frequency		PNP/NPN: Hz	250
		Relay output: Hz	-
			20
Delays		First-up: ms	< 15 (PNP/NPN); < 60 (relay output)
		Response: ms	< 2 (PNP/NPN); < 25 (relay output)
		Recovery: ms	< 2 (PNP/NPN); < 25 (relay output)

## Wiring schemes

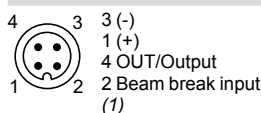
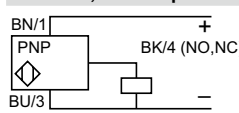
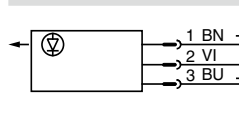
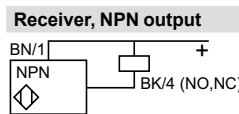
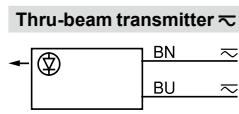
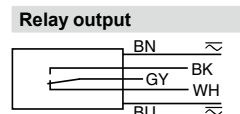
M12 connector	Pre-cabled, PNP/NPN	Receiver, PNP output	Thru-beam transmitter ---
 <p>4 3 3 (-) 1 2 1 (+) 4 OUT/Output 2 Beam break input (1)</p>	<p>(-) BU (Blue) (+) BN (Brown) OUT/Output BK (Black) Beam break input (1) VI (Violet)</p>	 <p>BN/1 PNP BK/4 (NO,NC) BU/3</p>	 <p>1 BN + 2 VI 3 BU -</p>
	<p>Pre-cabled, relay output</p> <p>(~) BU (Blue), (~) BN (Brown) Relay common/GY (Grey) NO BK (Black) NC WH (White)</p>	 <p>BN/1 NPN BK/4 (NO,NC) BU/3</p>	 <p>BN ~ BU ~</p>
			<p>Relay output</p>  <p>BN ~ BK ~ WH ~ BU ~</p>

(1) Beam break input on thru-beam transmitter only.

Input 2/VI:  
- not connected: beam made  
- connected to -: beam broken

## Detection curves

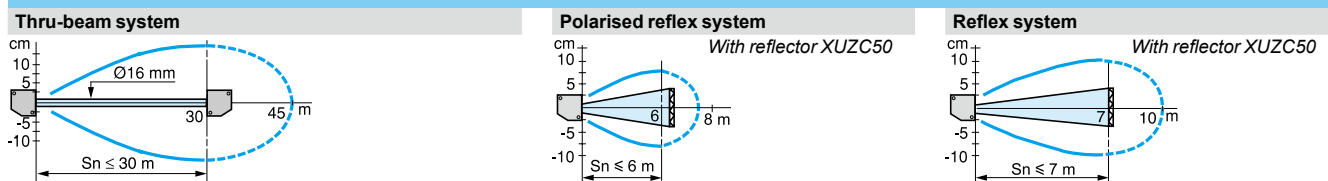

## Diffuse system

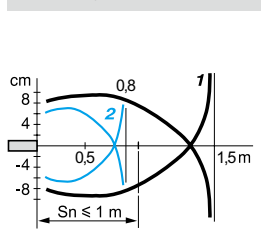

Object: 10 x 10 cm,  
1: white 90%, 2: grey 18%

## Dimensions

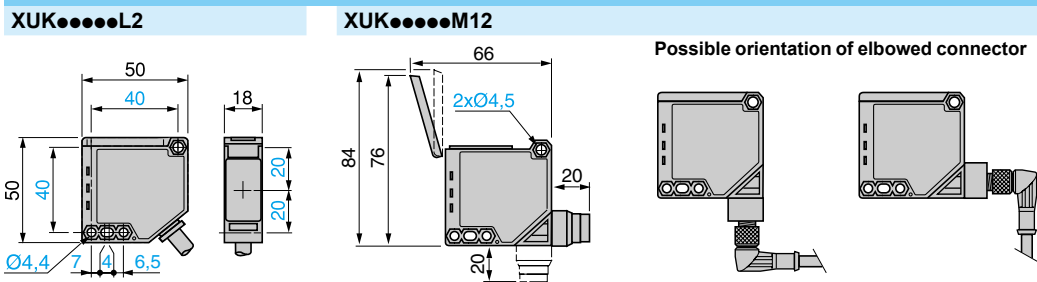

# Photo-electric sensors

OsiSense XU, general purpose, multimode function. Compact design 50 x 50  
Five-wire AC or DC, 1 CO relay output  
Three-wire DC, solid-state output

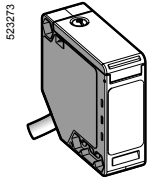

XUK0AKSAL2

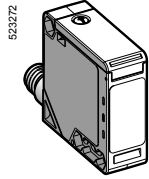

XUK0AKSAM12

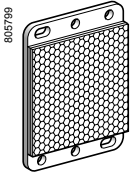

XUZC50

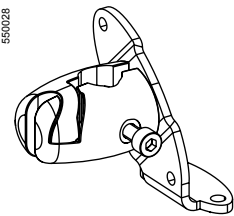

XUZK2003

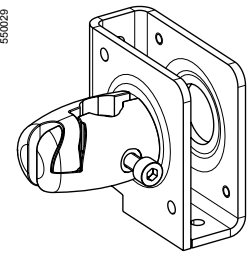

XUZK2004

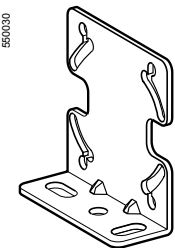

XUZA51

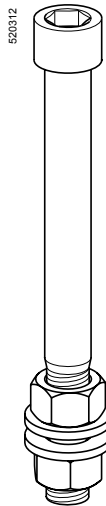

XUZ2001

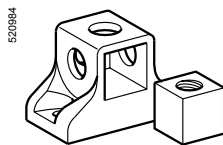

XUZ2003

## References

### DC

Sensing distance (Sn) m	Function	Output	Connection	Reference	Weight kg
0...30 depending on whether accessories are used	NO or NC, by programming	Time delay output	Pre-cabled (L = 2 m) (1) M12 connector	<b>XUK0AKSAL2</b> <b>XUK0AKSAM12</b>	0.175 0.090

### Accessories

Description	Connection	Reference	Weight kg
Transmitter for thru-beam function	Pre-cabled (L = 2 m) (1)	<b>XUK0AKSAL2T</b>	0.140
	M12 connector	<b>XUK0AKSAM12T</b>	0.090
Reflector 50 x 50 mm (2)	-	<b>XUZC50</b>	0.020

### AC or DC

Sensing distance (Sn) m	Function	Output	Connection	Reference	Weight kg
0...30 depending on whether accessories are used	NO or NC, by programming	Time delay relay	Pre-cabled (L = 2 m) (1)	<b>XUK0ARCTL2</b>	0.175

### Accessories

Description	Connection	Reference	Weight kg
Transmitter for thru-beam function	Pre-cabled (L = 2 m) (1)	<b>XUK0ARCTL2T</b>	0.140
Reflector 50 x 50 mm (2)	-	<b>XUZC50</b>	0.020

### Fixing accessories (2)

Description	Reference	Weight kg
<b>3D fixing kit</b> for use on M12 rod, for XUK or XUZC50	<b>XUZK2003</b>	0.170
<b>3D fixing kit</b> for use on M12 rod, with protective cover for XUK	<b>XUZK2004</b>	0.270
<b>M12 rod</b>	<b>XUZ2001</b>	0.050
<b>Support for M12 rod</b>	<b>XUZ2003</b>	0.150
<b>Fixing bracket</b>	<b>XUZA51</b>	0.050

(1) For a 5 m long cable replace L2 by L5; for a 10 m long cable replace L2 by L10.  
Example: XUK0AKSAL2 becomes XUK0AKSAL5 or XUK0AKSAL10.  
(2) For further information, see page 164.

## Dimensions (mm)

### XUK0A●●●L2

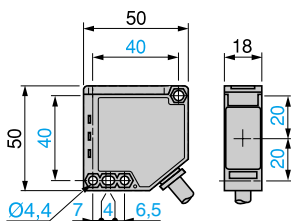

### XUK0A●●●M12

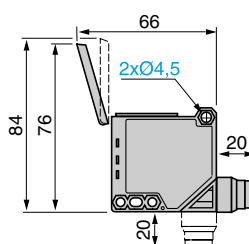

### Possible orientation of elbowed connector

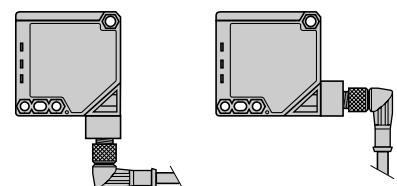

# Photo-electric sensors

OsiSense XU, general purpose, multimode function. Compact design 50 x 50  
Five-wire AC or DC, 1 CO relay output  
Three-wire DC, solid state output

Characteristics		XUK●●●●M12	XUK●●●●L2
Sensor type		M12 connector	
Product certifications		UL, CSA, CE	
Connection		M12 connector	Pre-cabled, length: 2 m
Sensing distance nominal Sn / maximum (excess gain = 2) (excess gain = 1)		<b>0.28 / 0.28 without accessory (diffuse with background suppression)</b> <b>0.8 / 1.2 without accessory (diffuse)</b> <b>4 / 5.7 with reflector (polarised reflex)</b> <b>30 / 35 with transmitter for thru-beam function (thru-beam)</b>	
Type of transmission		Infrared, except polarised reflex (red)	
Degree of protection		Conforming to IEC 60529 IP 65, double insulation	
Storage temperature		°C - 40...+ 70	
Operating temperature		°C - 25...+ 55	
Materials		Case	PBT
		Lens	PMMA
		Cable	- PvR
Vibration resistance		Conforming to IEC 60068-2-6 7 gn, amplitude ± 1.5 mm (f = 10 to 55 Hz)	
Shock resistance		Conforming to IEC 60068-2-27 30 gn, duration 11 ms	
Indicator lights		Output state	Yellow LED (transmission present for XUK0●●●●●T)
		Supply on	Green LED
		Optical alignment aid/dirty	Red LED (except for XUK0●●●●●T)
Alarm output		mA ≤ 50 with overload and short-circuit protection (except XUK0ARCT●)	
Rated supply voltage		PNP/NPN	V 12...24 --- with protection against reverse polarity
		Relay output	V - ≈ 24...240
Voltage limits (including ripple)		PNP/NPN	V 10...36 ---
		Relay output	V - ≈ 20...264
Current consumption, no-load		PNP/NPN	mA ≤ 35; 20 for XUK0AK●●●●T
Power consumption		Relay output	W - 3 ~ or ---
Switching capacity		PNP/NPN	mA ≤ 100 with overload and short-circuit protection
		Relay output	A - 3 ~ or ---
Voltage drop, closed state		V ≤ 1.5	
Time delay		s 0...10 on-delay, off-delay, monostable	
Maximum switching frequency		PNP/NPN	Hz 250 (200 for diffuse with background suppression)
		Relay output	Hz - 20
Delays		First-up	ms < 200 (PNP/NPN); < 300 (relay output)
		Response	ms < 2 (PNP/NPN); < 25 (relay output) (< 2.5 for diffuse with background suppression)
		Recovery	ms < 2 (PNP/NPN); < 25 (relay output) (< 2.5 for diffuse with background suppression)

## Wiring schemes

**M12 connector**

3 (-)  
1 (+)  
4 OUT/Output  
2 Alarm or beam break input (1)

**Pre-cabled**

(-) BU (Blue)  
(+) BN (Brown)  
OUT/Output BK (Black)  
Alarm/WH (White)  
Beam break input (1)/VI (Violet)

**Receiver, PNP output**

BN/1  
PNP  
BK/4  
WH/2  
BU/3

**Thru-beam transmitter ---**

Transmitter

1/BN +  
2/VI  
3/BU -

Input 2/VI:  
- not connected: beam made  
- connected to -: beam broken

**Pre-cabled, relay output**

(-) BU (Blue)  
(+) BN (Brown)  
Relay common/GY (Grey)  
NO BK (Black)  
NC WH (White)

**Receiver, NPN output**

BN/1  
NPN  
BK/4  
WH/2  
BU/3

**Thru-beam transmitter ~**

Transmitter

BN  
BU

**Relay output**

BN  
BK  
GY  
WH  
BU

(1) Beam break input on thru-beam transmitter only.

## Detection curves

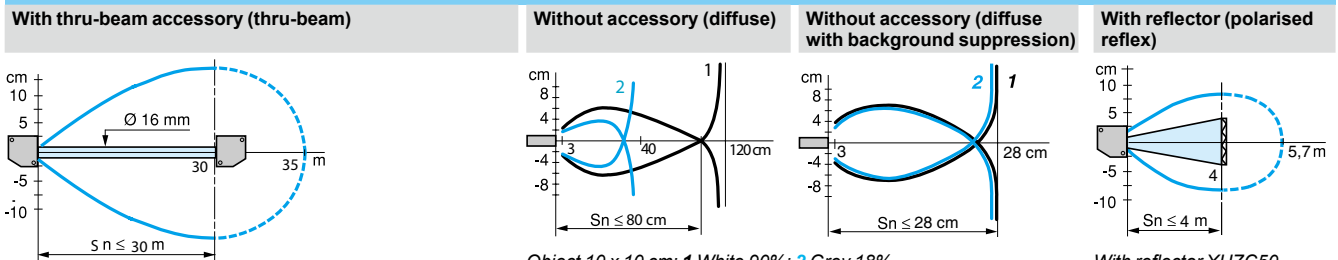

### Variation of usable sensing distance Su (without accessory, with adjustable background suppression)

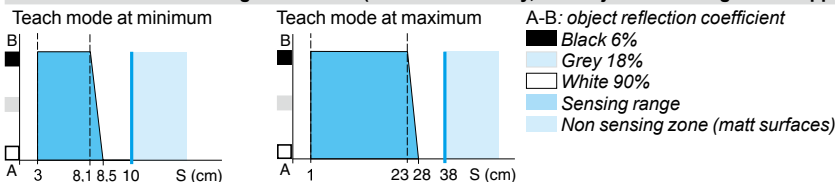

# Photo-electric sensors

OsiSense XU, general purpose  
With adjustable background suppression  
Mechanical display of setting  
DC supply. Solid-state output

## Compact design

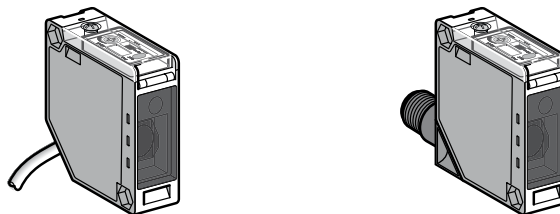

System	Diffuse with adjustable background suppression, long sensing distance with high accuracy (size of object $\geq 2$ mm)
Type of transmission	Infrared
Nominal sensing distance (Sn)	1 m

## References

3-wire, PNP or NPN programmable	NO or NC programmable function	XUK8AKSNL2	XUK8AKSNM12
Weight (kg)		0.190	0.070

## Characteristics

Product certifications	CE, UL, CSA
Ambient air temperature	For operation: - 25... + 55°C. For storage: - 30... + 70°C
Vibration resistance	Conforming to IEC 60068-2-6 7 gn (f = 10...55 Hz)
Shock resistance	Conforming to IEC 60068-2-27 10 gn, duration 11 ms
Degree of protection	Conforming to IEC 60529 IP 65 (IP 30 with cover open). NEMA 4X indoor use, 12 and 13 double insulation
Materials	Case: PC, lenses: PMMA, cable: PVC
Connection (1)	Pre-cabled, diameter 6 mm, length 2 m, wire c.s.a.: 5 x 0.34 mm <sup>2</sup> M12 male connector, 4-pin, can be set at 2 positions (suitable female connectors, including pre-wired versions)
Rated supply voltage	12...24 V $\overline{\text{DC}}$ with protection against reverse polarity
Voltage limits	10...36 V $\overline{\text{DC}}$ (including ripple)
Switching capacity (sealed)	$\leq 100$ mA with overload and short-circuit protection
Voltage drop, closed state	$\leq 1.5$ V
Current consumption, no-load	35 mA
Maximum switching frequency	250 Hz
Delays	First-up: $\leq 80$ ms; response: $\leq 2$ ms; recovery: $\leq 2$ ms

Function table	Function	Diffuse system	
		No object present in the beam	Object present in the beam
Output state (PNP or NPN) indicator: yellow LED (illuminated when sensor output is ON)	NO		
	NC		

(1) For a 10 m long cable replace L2 by L10.



# Photo-electric sensors

OsiSense XU, general purpose  
With adjustable background suppression  
Mechanical display of setting  
DC supply. Solid-state output

## Detection curves

### Variation of usable sensing distance $S_u$

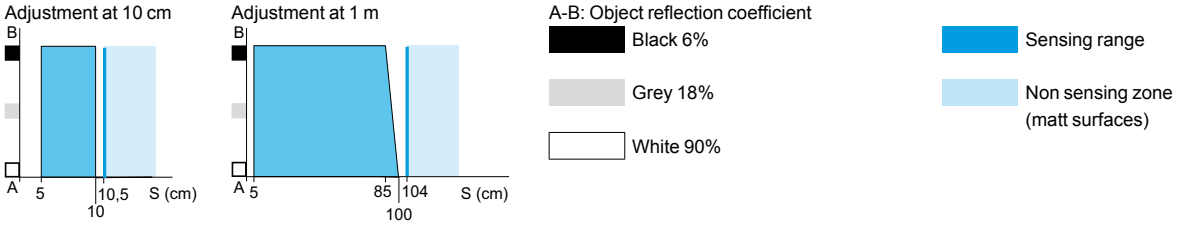

## Sensing distance adjustment

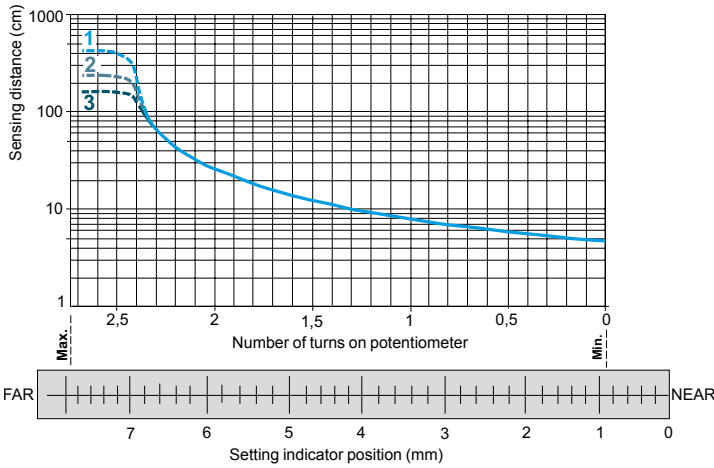

## Relative difference in sensing distances according to object colour

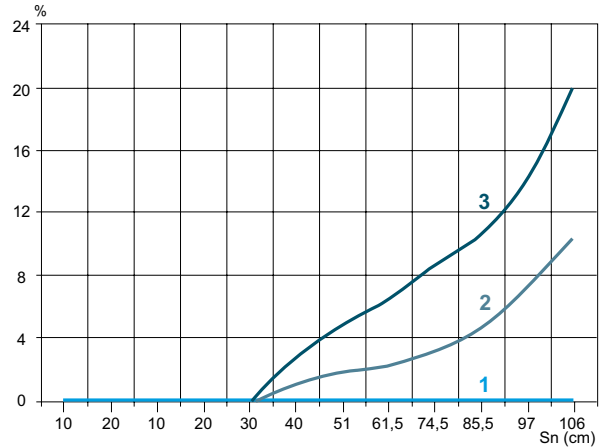

## Dimensions

### XUK8AKSNL2 (1)

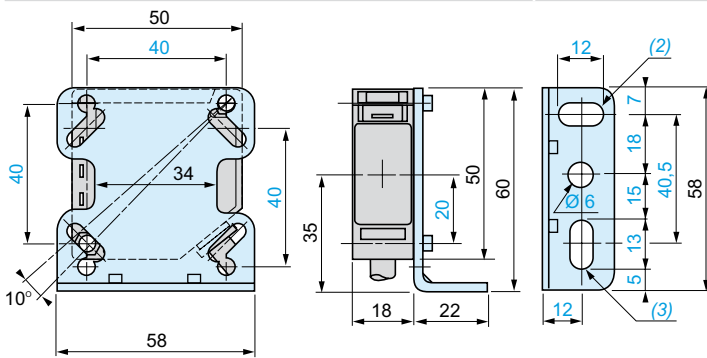

(1) The bracket XUZA51 is included with the sensor.

### Bracket fixing (1)

(2) 1 elongated hole  $\varnothing 6 \times 12$ .  
 (3) 1 elongated hole  $\varnothing 6 \times 13$ .

### XUK8AKSNM12 with cover open (1)

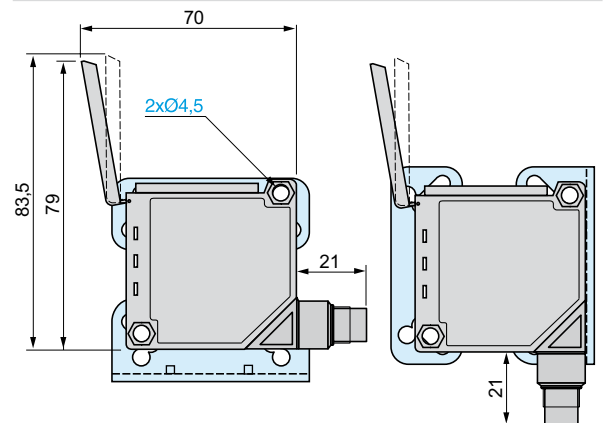

## Functions

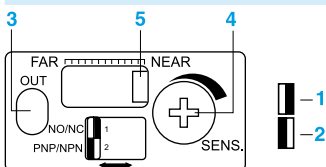

### Switches

- 1 NO/NC programming
- 2 PNP or NPN output

### LED

- 3 Yellow LED, output

### Potentiometer

- 4 Sensing distance adjustment

### Setting indicator

- 5 Potentiometer setting indication

## Wiring schemes (3-wire ---)

### NO/NC programming

#### PNP output

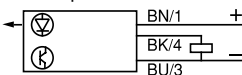

#### NPN output

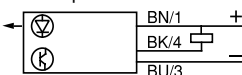

NO: detection of object presence  
 NC: detection of object absence

## Cable connections

### XUK8AKSNL2

- (-) BU (Blue)
- (+) BN (Brown)
- (OUT) BK (Black)

## Connector schemes

### XUK8AKSNM12



# Photo-electric sensors

OsiSense XU, general purpose  
With adjustable background suppression  
Compact design, 50 x 50  
Five-wire AC or DC, 1 "C/O" relay output

## Compact design

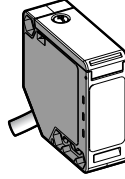

System	Diffuse with adjustable background suppression
Type of transmission	Infrared
Nominal sensing distance (Sn)	0.75 m

## References

3-wire, PNP or NPN programmable	NO or NC programmable function	XUK8ARCTL2
Weight (kg)		0.190

## Characteristics

Product certifications		CE, UL, CSA
Ambient air temperature		For operation: - 25... + 55°C. For storage: - 30... + 70°C
Vibration resistance	Conforming to IEC 60068-2-6	7 gn (f = 10...55 Hz)
Shock resistance	Conforming to IEC 60068-2-27	10 gn, duration 11 ms
Degree of protection	Conforming to IEC 60529	IP 65 double insulation $\square$ (IP 30 with cover open)
Materials		Case: PBT Lenses: PMMA Cable: PVC
Indicator lights	Output state	Yellow LED
	Supply on	Green LED
	Optical alignment aid/dirty	Red LED
Connection		Pre-cabled, diameter 6 mm, length 2 m, wire c.s.a.: 5 x 0.34 mm <sup>2</sup>
Rated supply voltage		24...240 V $\sim$ or $\text{---}$
Voltage limits		20...264 V $\sim$ or $\text{---}$ (including ripple)
Switching capacity		3 A: $\cos \varphi = 1$ 0.5 A: $\cos \varphi = 0.4$
Voltage drop, closed state		$\leq 1.5$ V
Power consumption		3 W ( $\sim$ or $\text{---}$ )
Maximum switching frequency		200 Hz ( $\text{---}$ ); 20 Hz ( $\sim$ )
Time delay		0...15 s: on-delay, off-delay, monostable
Delays		First-up: $\leq 300$ ms; response: $\leq 2$ ms; recovery: $\leq 2$ ms

Function table	Function	Diffuse system			
		No object present in the beam		Object present in the beam	
Output state (PNP or NPN) indicator: yellow LED (illuminated when sensor output is ON)	NO				
	NC				

# Photo-electric sensors

OsiSense XU, general purpose

With adjustable background suppression

Compact design, 50 x 50

Five-wire AC or DC, 1“C/O” relay output

## Detection curves

### Variation of usable sensing distance Su

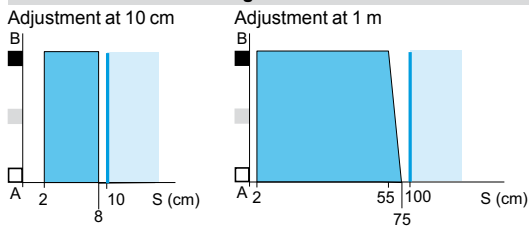

### Detection curves

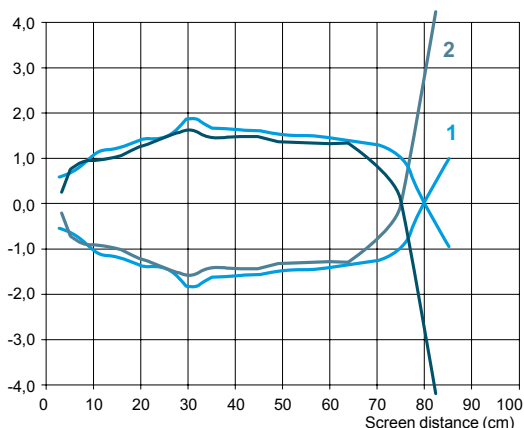

### Relative difference in sensing distances according to object colour

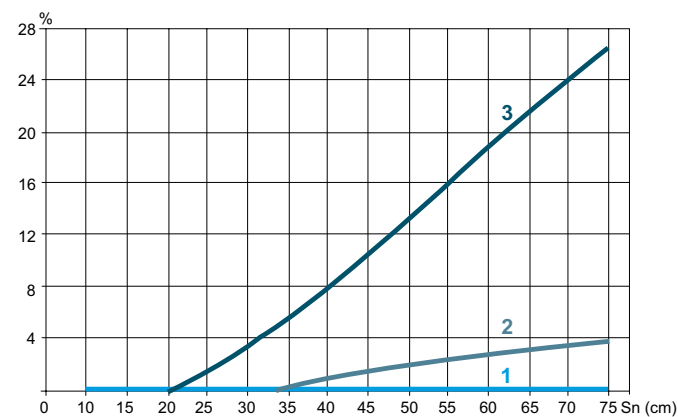

## Dimensions

### XUK8ARCTL2

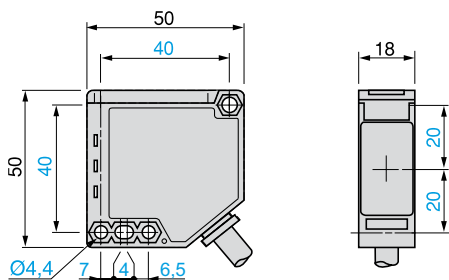

### XUK8ARCTL2 with cover open

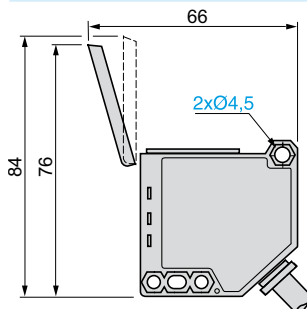

## Connections

### Wiring scheme

Cable connection, relay output

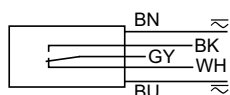

⊘ : BU (Blue)

⊘ : BN (Brown)

Relay common: GY (Grey)

NO: BK (Black), detection of object

NC: WH (White), detection of object absence

## Description

### Indicators and settings

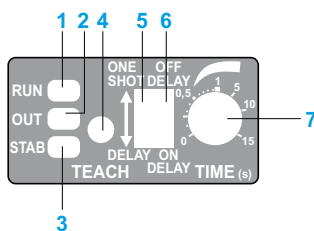

1 RUN (Supply on): Green LED

2 OUT (Output state): Yellow LED

3 STAB (Optical alignment aid/dirty): Red LED

4 TEACH: Teach mode button

5 ONE SHOT or DELAY (monostable or time delay)

6 ON DELAY, OFF DELAY (on-delay, off-delay)

7 Time delay potentiometer (0..15 s)

# Photo-electric sensors

OsiSense XU, general purpose, single mode function. Compact design  
Five-wire AC or DC, 1 CO relay output  
Three-wire DC, solid-state output

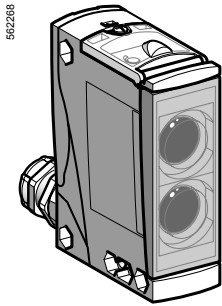

XUX●A●●●T16

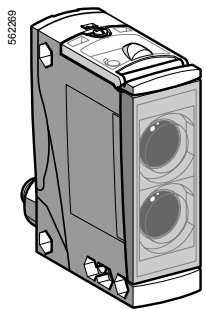

XUX●A●●●M12

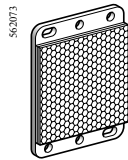

XUZC50

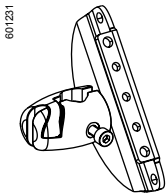

XUZX2003

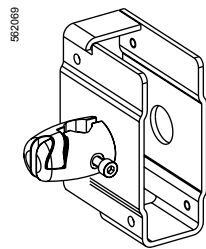

XUZX2004



XUZ2001

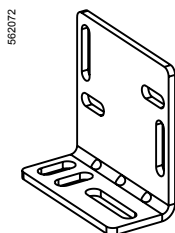

XUZX2000

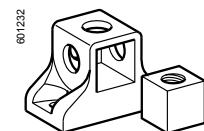

XUZX2003

Sensing distance (Sn) m	Function	Output	Connection	Reference	Weight kg	
<b>Diffuse system (1)</b>						
<b>DC</b>						
2.1	NO	PNP	Screw terminals (3)	<b>XUX5APANT16</b>	0.200	
			M12 connector	<b>XUX5APANM12</b>	0.200	
	NC	NPN	Screw terminals (3)	<b>XUX5ANANT16</b>	0.200	
			M12 connector	<b>XUX5ANANM12</b>	0.200	
	NC	PNP	Screw terminals (3)	<b>XUX5APBNT16</b>	0.200	
			M12 connector	<b>XUX5APBNM12</b>	0.200	
NC	NPN	Screw terminals (3)	<b>XUX5ANBNT16</b>	0.200		
		M12 connector	<b>XUX5ANBNM12</b>	0.200		
<b>AC or DC</b>						
2.1	NO + NC	Relay	Screw terminals (3)	<b>XUX5ARCNT16</b>	0.200	
<b>Polarised reflex system (1)</b>						
<b>DC</b>						
11	NO	PNP	Screw terminals (3)	<b>XUX9APANT16</b>	0.200	
			M12 connector	<b>XUX9APANM12</b>	0.200	
	NC	NPN	Screw terminals (3)	<b>XUX9ANANT16</b>	0.200	
			M12 connector	<b>XUX9ANANM12</b>	0.200	
	NC	PNP	Screw terminals (3)	<b>XUX9APBNT16</b>	0.200	
			M12 connector	<b>XUX9APBNM12</b>	0.200	
NC	NPN	Screw terminals (3)	<b>XUX9ANBNT16</b>	0.200		
		M12 connector	<b>XUX9ANBNM12</b>	0.200		
<b>AC or DC</b>						
11	NO + NC	Relay	Screw terminals (3)	<b>XUX9ARCNT16</b>	0.200	
<b>Reflector 50 x 50 mm (2)</b>					<b>XUZC50</b>	0.020
<b>Reflex system (1)</b>						
<b>DC</b>						
14	NO	PNP	Screw terminals (3)	<b>XUX1APANT16</b>	0.200	
			M12 connector	<b>XUX1APANM12</b>	0.200	
	NC	NPN	Screw terminals (3)	<b>XUX1ANANT16</b>	0.200	
			M12 connector	<b>XUX1ANANM12</b>	0.200	
	NC	PNP	Screw terminals (3)	<b>XUX1APBNT16</b>	0.200	
			M12 connector	<b>XUX1APBNM12</b>	0.200	
NC	NPN	Screw terminals (3)	<b>XUX1ANBNT16</b>	0.200		
		M12 connector	<b>XUX1ANBNM12</b>	0.200		
<b>AC or DC</b>						
14	NO + NC	Relay	Screw terminals (3)	<b>XUX1ARCNT16</b>	0.200	
<b>Reflector 50 x 50 mm (2)</b>					<b>XUZC50</b>	0.020
<b>Thru-beam system (1)</b>						
<b>DC</b>						
<b>Transmitter 40</b>			Screw terminals (3)	<b>XUX0AKSAT16T</b>	0.200	
<b>Receiver 40</b>			M12 connector	<b>XUX0AKSAM12T</b>	0.200	
40	NO	PNP	Screw terminals (3)	<b>XUX2APANT16R</b>	0.200	
			M12 connector	<b>XUX2APANM12R</b>	0.200	
	NC	NPN	Screw terminals (3)	<b>XUX2ANANT16R</b>	0.200	
			M12 connector	<b>XUX2ANANM12R</b>	0.200	
NC	PNP	Screw terminals (3)	<b>XUX2APBNT16R</b>	0.200		
		M12 connector	<b>XUX2APBNM12R</b>	0.200		
NC	NPN	Screw terminals (3)	<b>XUX2ANBNT16R</b>	0.200		
		M12 connector	<b>XUX2ANBNM12R</b>	0.200		
<b>AC or DC</b>						
<b>Transmitter 40</b>			Screw terminals (3)	<b>XUX0ARCTT16T</b>	0.200	
<b>Receiver 40</b>			Screw terminals (3)	<b>XUX2ARCNT16R</b>	0.200	
<b>Fixing accessories (2)</b>						
<b>Description</b>				<b>Reference</b>	<b>Weight kg</b>	
<b>3D fixing kit</b> for use on M12 rod, for XUX or XUZC50				<b>XUZX2003</b>	0.220	
<b>3D fixing kit</b> for use on M12 rod, with protective cover for XUX				<b>XUZX2004</b>	0.420	
<b>M12 rod</b>				<b>XUZ2001</b>	0.050	
<b>Support for M12 rod</b>				<b>XUZX2003</b>	0.150	
<b>Fixing bracket</b>				<b>XUZX2000</b>	0.120	

(1) With adjustable sensitivity.

(2) For further information, see page 164.

(3) Screw terminals with ISO 16 cable gland for cable Ø 7 to 10 mm.

# Photo-electric sensors

OsiSense XU, general purpose,  
single mode function. Compact design  
Five-wire AC or DC, 1 CO relay output  
Three-wire DC, solid-state output

Characteristics		XUX●●●●●M12	XUX●AN●NT16, ●AP●NT16	XUX●ARC●T16
Sensor type				
Product certifications		UL, CSA, CE		
Connection		M12 connector	Screw terminals, ISO 16 cable gland	
Sensing distance nominal $S_n$ / maximum (excess gain = 2) (excess gain = 1)	m	2.1 / 3 diffuse with adjustable sensitivity		
	m	11 / 15 polarised reflex with adjustable sensitivity (with reflector XUZC50)		
	m	14 / 19 reflex with adjustable sensitivity		
	m	40 / 60 thru-beam with adjustable sensitivity		
Type of transmission		Infrared, except polarised reflex (red)		
Degree of protection	Conforming to IEC 60529	IP 65, IP 67, double insulation $\square$		
Storage temperature		°C -40...+70		
Operating temperature		°C -25...+55		
Materials	Case	PBT		
	Lens	PMMA		
Vibration resistance	Conforming to IEC 60068-2-6	7 gn, amplitude $\pm 1.5$ mm ( $f = 10$ to 55 Hz)		
Shock resistance	Conforming to IEC 60068-2-27	30 gn, duration 11 ms		
Indicator lights	Output state	Yellow LED (transmission present for XUX0●●●●●T ---)		
	Supply on	Green LED		
	Instability	Red LED (for XUX9ARCNT16)		
Rated supply voltage	PNP/NPN	V 12...24 with protection against reverse polarity		
	Relay output	V -	24...240 ~ or ---	
Voltage limits (including ripple)	PNP/NPN	V -		
	Relay output	V -	20...264 ~ or ---	
Current consumption, no-load	PNP/NPN	mA $\leq 35$ (20 for XUX0●●●●●T)		
Power consumption	Relay output	W -	2 ~ or ---	
Switching capacity	PNP/NPN	mA $\leq 100$ with overload and short-circuit protection		
	Relay output	A -	500 000 operating cycles 3A: $\cos \varphi = 1/0.5$ A: $\cos \varphi = 0.4$	
Voltage drop, closed state		V $\leq 1.5$		
Maximum switching frequency	PNP/NPN	Hz 250		
	Relay output	Hz -	20	
Delays	First-up	ms $< 15$ (PNP/NPN); $< 60$ (relay output)		
	Response	ms $< 2$ (PNP/NPN); $< 25$ (relay output)		
	Recovery	ms $< 2$ (PNP/NPN); $< 25$ (relay output)		

## Wiring schemes

M12 connector	Relay output ~	PNP/NPN ---	Transmitter ---	Transmitter ~
	<b>Terminals</b> 1 $\odot$ ~ 2 $\odot$ ~ 3 NO 4 $\odot$ Relay common 5 $\odot$ NC	<b>M12 Terminals</b> 1 $\bullet$ 1 $\odot$ + 3 $\bullet$ 2 $\odot$ - 4 $\bullet$ 3 $\odot$ Output	<b>M12 Terminals</b> 1 $\bullet$ 1 $\odot$ + 3 $\bullet$ 2 $\odot$ - 2 $\bullet$ 3 $\odot$ Beam break input (1) (1) Input not connected: beam made. Input connected to -: beam broken.	<b>Terminals</b> 1 $\odot$ ~ 2 $\odot$ ~

Maximum permissible conductor c.s.a.: 1 x 1.5 mm<sup>2</sup> or 1 x 0.75 mm<sup>2</sup> with cable end.

## Detection curves

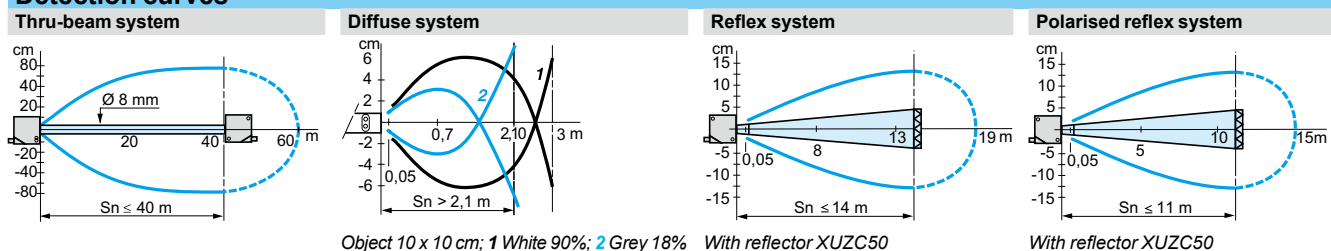

## Dimensions

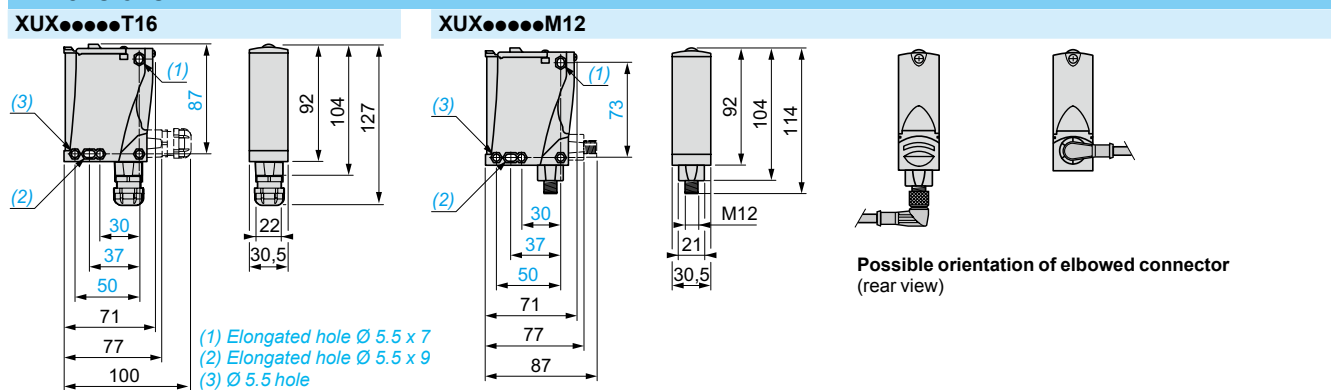

# Photo-electric sensors

OsiSense XU, general purpose, multimode function <sup>(1)</sup>

Compact design

Five-wire AC or DC, 1 CO relay output

Three-wire DC, solid-state output

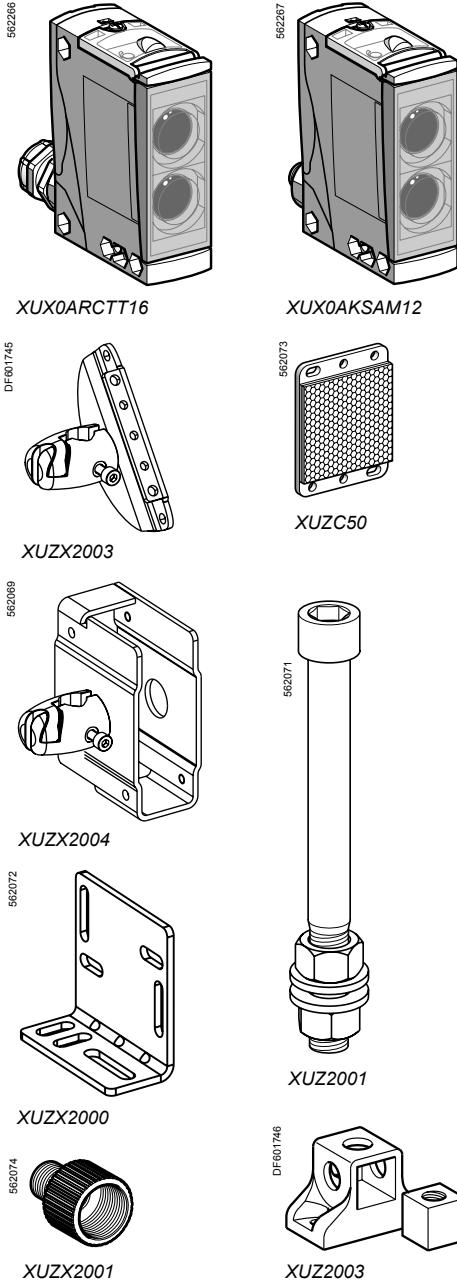

## References

### DC

Sensing distance (Sn) m	Function	Output	Connection	Reference	Weight kg
0...40 depending on whether accessories are used	NO or NC, by programming	PNP/NPN	Screw terminals, ISO 16 cable gland (3) M12 connector	XUX0AKSAT16 XUX0AKSAM12	0.200 0.200

### Accessories

Description	Connection	Reference	Weight kg
Transmitter for thru-beam function	Screw terminals, ISO 16 cable gland (3) M12 connector	XUX0AKSAT16T XUX0AKSAM12T	0.200 0.200
Reflector 50 x 50 mm	-	XUZC50	0.020

### AC or DC

Sensing distance (Sn) m	Function	Output	Connection	Reference	Weight kg
0...40 depending on whether accessories are used	NO or NC, by programming	Time delay relay	Screw terminals, ISO 16 cable gland (3)	XUX0ARCTT16	0.200

### Accessories

Description	Connection	Reference	Weight kg
Transmitter for thru-beam function	Screw terminals, ISO 16 cable gland (3)	XUX0ARCTT16T	0.200
Reflector 50 x 50 mm	-	XUZC50	0.020

### Fixing accessories (2)

Description	Reference	Weight kg
3D fixing kit for use on M12 rod, for XUX or XUZC50	XUZ2003	0.220
3D fixing kit for use on M12 rod, with protective cover for XUX	XUZ2004	0.420
M12 rod	XUZ2001	0.050
Support for M12 rod	XUZ2003	0.150
Fixing bracket	XUZ2000	0.120
Adaptor, ISO 16 - 1/2" NPT	XUZ2001	0.050
Adaptor, ISO 16 - ISO 20	XUZ2002	0.050

(1) For further information on the multimode function, see page 14.

(2) For further information, see page 162.

(3) For Ø 7 to 10 mm cable.

## Dimensions

### XUX●●●●T16

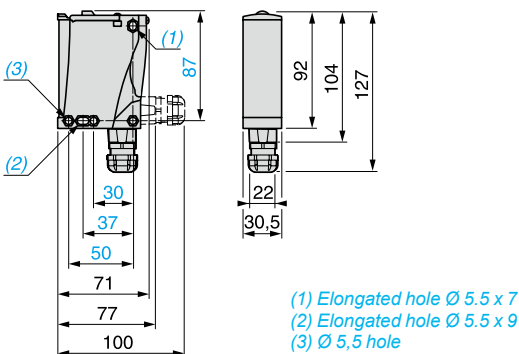

### XUX●●●●M12

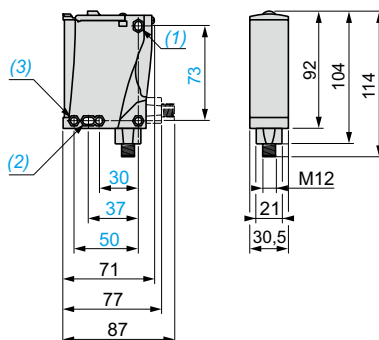

### Possible orientation of elbowed connector (rear view)

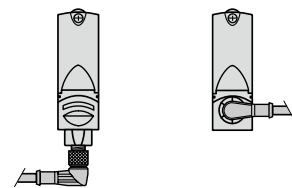

# Photo-electric sensors

OsiSense XU, general purpose, multimode function

Compact design

Five-wire AC or DC, 1 CO relay output

Three-wire DC, solid-state output

## Characteristics

		XUX●●●●●M12	XUX●●●●●T16
<b>Sensor type</b>		UL, CSA, CE	
<b>Product certifications</b>		M12 connector	
<b>Connection</b>		Screw terminals, ISO 16 cable gland	
<b>Sensing distance</b>		m 1.3 / 1.3 without accessory (diffuse with background suppression)	
nominal $S_n$ / maximum		m 2 / 3 without accessory (diffuse)	
(excess gain = 2) (excess gain = 1)		m 15 / 18 with reflector (polarised reflex)	
		m 40 / 60 with transmitter for thru-beam function (thru-beam)	
<b>Type of transmission</b>		Infrared, except for polarised reflex (red)	
<b>Degree of protection</b>		Conforming to IEC 60529 IP 65, IP 67, double insulation	
<b>Storage temperature</b>		°C -40...+70	
<b>Operating temperature</b>		°C -25...+55	
<b>Materials</b>		Case: PBT Lens: PMMA	
<b>Vibration resistance</b>		Conforming to IEC 60068-2-6 7 gn, amplitude $\pm 1.5$ mm (f = 10 to 55 Hz)	
<b>Shock resistance</b>		Conforming to IEC 60067-2-27 30 gn, duration 11 ms	
<b>Indicator lights</b>		Output state: Yellow LED (transmission present for XUX0●●●●●T) Supply on: Green LED Stability: Red LED (except for XUX0●●●●●T)	
<b>Rated supply voltage</b>		PNP/NPN: V $\approx 12...24$ with protection against reverse polarity Relay output: V - 24...240 $\sim$ or $\approx$	
<b>Voltage limits (including ripple)</b>		PNP/NPN: V $\approx 10...36$ Relay output: V - 20...264 $\sim$ or $\approx$	
<b>Current consumption, no-load</b>		PNP/NPN: mA $\leq 35$ (20 for XUX0●●●●●T)	
<b>Power consumption</b>		Relay output: W - 2 $\sim$ or $\approx$	
<b>Alarm output</b>		mA $\leq 100$ with overload and short-circuit protection	
<b>Switching capacity</b>		PNP/NPN: mA $\leq 100$ with overload and short-circuit protection Relay output: A - 500 000 operating cycles 3 A: $\cos \varphi = 1/0.5$ A: $\cos \varphi = 0.4$	
<b>Voltage drop, closed state</b>		V $\leq 1.5$	
<b>Maximum switching frequency</b>		PNP/NPN: Hz 240 Relay output: Hz - 20	
<b>Time delay</b>		Relay output: s - 0.02...15 on-delay, off-delay, monostable	
<b>Delays</b>		First-up: ms $< 200$ Response: ms $< 2$ (PNP/NPN); $< 25$ (relay output) Recovery: ms $< 2$ (PNP/NPN); $< 25$ (relay output)	

## Wiring schemes

### M12 connector



### Relay output $\sim$

#### Terminals

- 1  $\sim$
- 2  $\sim$
- 3 NO
- 4 Relay common
- 5 NC

### PNP/NPN $\approx$

#### M12 Terminals

- 1 ● 1  $\ominus$  +
- 3 ● 2  $\ominus$  -
- 4 ● 3  $\ominus$  Output
- 2 ● 4  $\ominus$  Alarm

### Transmitter $\approx$

#### M12 Terminals

- 1 ● 1  $\ominus$  +
  - 3 ● 2  $\ominus$  -
  - 2 ● 3  $\ominus$  Beam break input (1)
- (1) Input not connected: beam made.  
Input connected to -: beam broken.

### Transmitter $\sim$

#### Terminals

- 1  $\sim$
- 2  $\sim$

Maximum permissible conductor c.s.a.: 1 x 1.5 mm<sup>2</sup> or 1 x 0.75 mm<sup>2</sup> with cable end.

## Detection curves

### With thru-beam accessory (thru-beam)

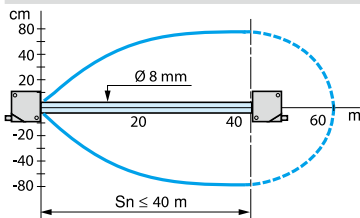

### Without accessory (diffuse)

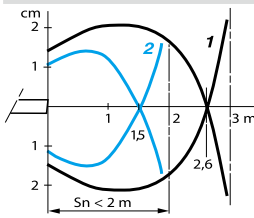

### Without accessory (diffuse with background suppression)

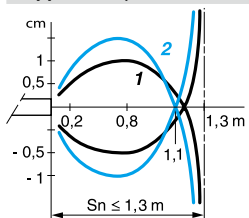

### With reflector (polarised reflex)

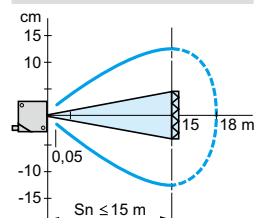

Object: 10 x 10 cm, 1: white 90%, 2: grey 18%

With reflector XUZC50

### Variation of usable sensing distance $S_u$ (without accessory, with adjustable background suppression)

#### Teach mode at minimum.

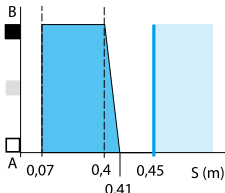

#### Teach mode at maximum.

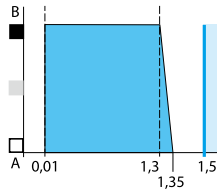

A-B: object reflection coefficient

- Black 6%
- Grey 18%
- White 90%
- Sensing range
- Non sensing zone (matt surfaces)

# Photo-electric sensors

OsiSense XU, general purpose  
With adjustable background suppression  
Five-wire AC or DC, 1 CO relay output  
Three-wire DC, solid-state output

## Compact design



System	Diffuse with adjustable background suppression, long sensing distance with high accuracy
Type of transmission	Infrared
Nominal sensing distance (Sn)	2 m

## References

5-wire, AC/DC with terminal connections and ISO 16 cable gland	NO or NC programmable function	XUX8ARCTT16	-	
3-wire, PNP or NPN programmable	NO or NC programmable function	-	XUX8AKSAT16	XUX8AKSAM12
Weight (kg)		0.200	0.200	0.200

## Characteristics

Product certifications		CE, UL, CSA
Ambient air temperature		For operation: - 25...+ 55 °C. For storage: - 40...+ 70 °C
Vibration resistance	Conforming to IEC 60068-2-6	7 gn (f = 10...55 Hz)
Shock resistance	Conforming to IEC 60068-2-27	10 gn, duration 11 ms
Degree of protection	Conforming to IEC 60529	IP 65, IP 67, double insulation (IP 30 with cover open)
Materials		Case: PC, lenses: PMMA
Connection		Terminal connections via ISO 16 cable gland (7 to 10 mm cable)   M12 male connector, 4-pin, can be set at 2 positions
Rated supply voltage		~ or 24...240 V   12...24 V with protection against reverse polarity
Voltage limits		~ or 20...264 V (including ripple)   10...0.36V (including ripple)
Switching capacity (sealed)	Relay output PNP/NPN	500 000 operating cycles; 3A Cos φ = 1; 0.5 A Cos φ = 0.4 -   ≤ 100 mA with overload and short-circuit protection
Indicator light	Output state Supply on Stability	Yellow LED Green LED Red LED
Voltage drop, closed state		≤ 1.5 V
Current consumption, no-load		35 mA
Maximum switching frequency	Relay output PNP/NPN	20 Hz   - -   150 Hz
Time delay	Relay output	0.02...15 s monostable, on delay or off-delay
Delays	Relay output PNP/NPN	First-up: ≤ 200 ms; response: ≤ 25 ms; recovery: ≤ 25 ms -   First-up: ≤ 200 ms; response: ≤ 3.5 ms; recovery: ≤ 2.5 ms

Function table	Function	Diffuse system	
		No object present in the beam	Object present in the beam
Output state (PNP or NPN) indicator: yellow LED (illuminated when sensor output is ON)	NO		
	NC		



# Photo-electric sensors

OsiSense XU, general purpose  
With adjustable background suppression  
Five-wire AC or DC, 1 CO relay output  
Three-wire DC, solid-state output

## Detection curves

### Variation of usable sensing distance Su

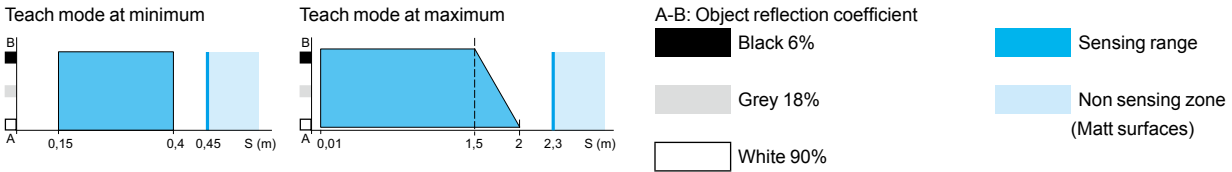

## Detection curves

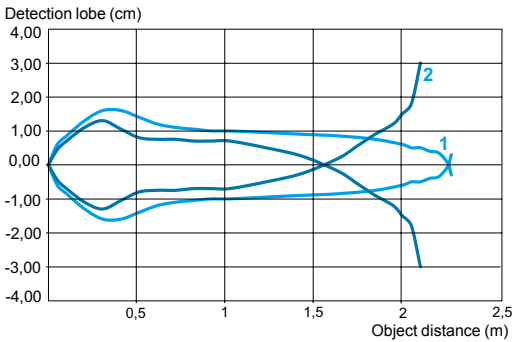

Object: 10 x 10 cm

- 1 white 90%
- 2 grey 18%

## Relative difference in sensing distances according to object colour

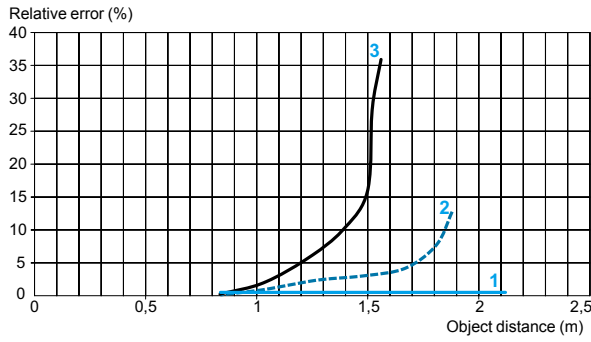

Object: 10 x 10 cm

- 1 white 90%
- 2 grey 18%
- 3 black 6%

## Dimensions

### XUX●●●●●T16

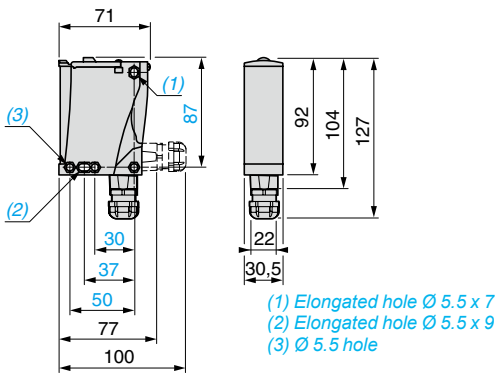

### XUX●●●●●M12

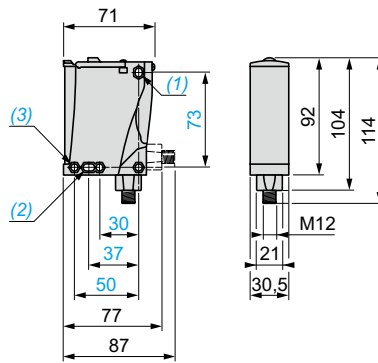

### Possible orientation of elbowed connector (rear view)

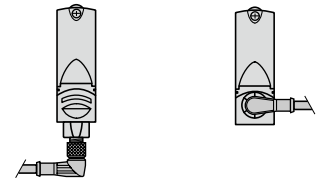

## Wiring schemes

### M12 connector



### Relay output $\sim$

#### Terminals

- 1  $\sim$
- 2  $\sim$
- 3 NO
- 4 Relay common
- 5 NC

### PNP/NPN $\text{---}$

#### M12 Terminals

- 1  $\bullet$  1  $\text{Ø } +$
- 3  $\bullet$  2  $\text{Ø } -$
- 4  $\bullet$  3  $\text{Ø } \text{Output}$
- 2  $\bullet$  4  $\text{Ø } \text{Alarm inactive}$

Maximum permissible conductor c.s.a.: 1 x 1.5 mm<sup>2</sup>  
or 1 x 0.75 mm<sup>2</sup> with cable end.

## Typical application

### Wrapping system/outer wrapping

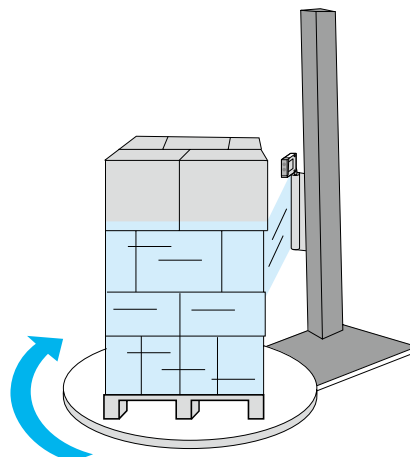

# Photo-electric sensors

OsiSense XU  
Optical fork without adjustment  
DC supply. Solid-state output

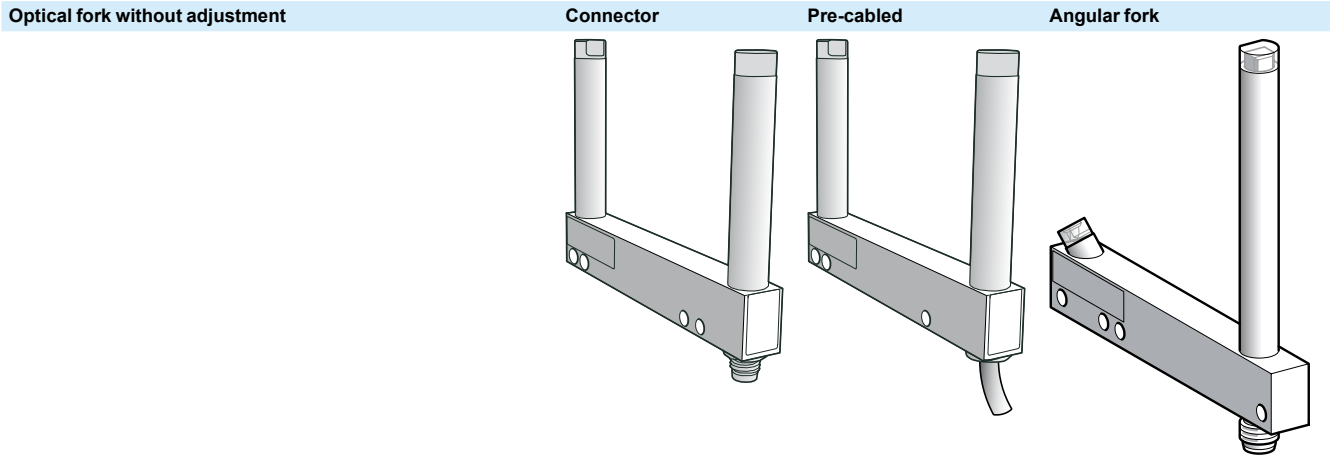

<b>System</b>	<b>Thru-beam</b>		
<b>Type of transmission</b>	Red LED, modulated		
<b>Nominal sensing distance (Sn)</b>	<b>2...180 mm</b>		
<b>Minimum size of object detected</b>	Passageway 2...120 mm	<b>0.8 mm</b>	<b>1.2 mm</b>
	Passageway ≥ 150 mm	<b>1 mm</b>	<b>1.5 mm</b>
<b>Fork type</b>	<b>XUVR●</b>		<b>XUVA●</b>

### References of forks type XUVR●

<b>3-wire</b> <b>NO or NC function</b> <b>PNP or NPN output</b>		<b>Passageway (A)</b>	<b>Function</b>	<b>Output</b>	<b>Pre-cabled, length 2 m. Depth (B): 40 mm</b>
		30 mm	NO	PNP	<b>XUVR0303PANL2</b>
		50 mm	NO	PNP	<b>XUVR0605PANM8</b>
	NPN			<b>XUVR0605NANM8</b>	
	NC		PNP	<b>XUVR0605PBNM8</b>	
			NPN	<b>XUVR0605NBNM8</b>	
	80 mm	NO	PNP	<b>XUVR0608PANM8</b>	
			NPN	<b>XUVR0608NANM8</b>	
		NC	PNP	<b>XUVR0608PBNM8</b>	
			NPN	<b>XUVR0608NBNM8</b>	
	120 mm	NO	PNP	<b>XUVR1212PANM8</b>	
			NPN	<b>XUVR1212NANM8</b>	
NC		PNP	<b>XUVR1212PBNM8</b>		
		NPN	<b>XUVR1212NBNM8</b>		
180 mm	NO	PNP	<b>XUVR1218PANM8</b>		
		NPN	<b>XUVR1218NANM8</b>		
	NC	PNP	<b>XUVR1218PBNM8</b>		
		NPN	<b>XUVR1218NBNM8</b>		

<b>Weight (kg)</b>	0.080 to 0.190 depending on model
--------------------	-----------------------------------

### References of forks type XUVA●

<b>3-wire</b> <b>NO function, PNP output</b>		<b>Type</b>	<b>Function</b>	<b>Output</b>	<b>M8 connector, 3-pin</b>
		50 mm	NO	PNP	<b>XUVA0505PANM8</b>
		80 mm	NO	PNP	<b>XUVA0808PANM8</b>
		120 mm	NO	PNP	<b>XUVA1212PANM8</b>
		150 mm	NO	PNP	<b>XUVA1515PANM8</b>

<b>Weight (kg)</b>	0.100 to 0.195 depending on model
--------------------	-----------------------------------

Other versions: please consult our Customer Care Centre.

Applications: detection on conveyor, detection on vibrating rail.

### Accessories

Description	Details	Length of cable	Reference	Weight kg
Pre-wired M8 connector	Straight	2 m	<b>XZCP0566L2</b>	0.060
	Elbowed (90°)	2 m	<b>XZCP0666L2</b>	0.060
	Straight	5 m	<b>XZCP0566L5</b>	0.120
	Elbowed (90°)	5 m	<b>XZCP0666L5</b>	0.120

Characteristics		XUVR●	XUVA
<b>Product certifications</b>		CE, UL, CSA	CE
<b>Ambient air temperature</b>	For operation	- 10...+ 60 °C	
	For storage	- 40...+ 80 °C	
<b>Degree of protection</b>	Conforming to IEC 60529	IP 65 and IP 67	
<b>Vibration resistance</b>	Conforming to IEC 60068-2-6	7 gn, amplitude ± 0.75 mm (f = 10 to 55 Hz)	
<b>Shock resistance</b>	Conforming to IEC 60068-2-27	30 gn, duration 11 ms	
<b>Materials</b>	Case	Painted aluminium and polyamide	
<b>Rated supply voltage</b>		— 12...24 V with protection against reverse polarity	
<b>Voltage limits (including ripple)</b>		— 10...30 V	
<b>Immunity to ambient light</b>	Natural light	10 000 lux	
	Incandescent bulb	5000 lux	
<b>Switching capacity</b>		<b>100 mA with overload and short-circuit protection</b>	
<b>Voltage drop, closed state</b>		< 1.5 V	
<b>Current consumption, no-load</b>		< 20 mA	
<b>Maximum switching frequency</b>		<b>4000 Hz</b>	
<b>Delays</b>	First-up	140 ms max.	
	Stability	± 15 µs	
<b>Indicator lights</b>	Yellow LED	Output signal	

### Dimensions

#### XUVR●

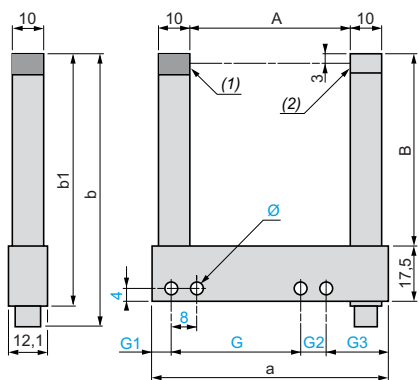

XUVR0303● (pre-cabled version detail) Orientation of elbowed connector

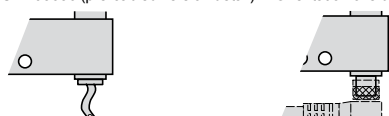

(1) Transmission LED - (2) Yellow LED: output signal

#### XUVA●

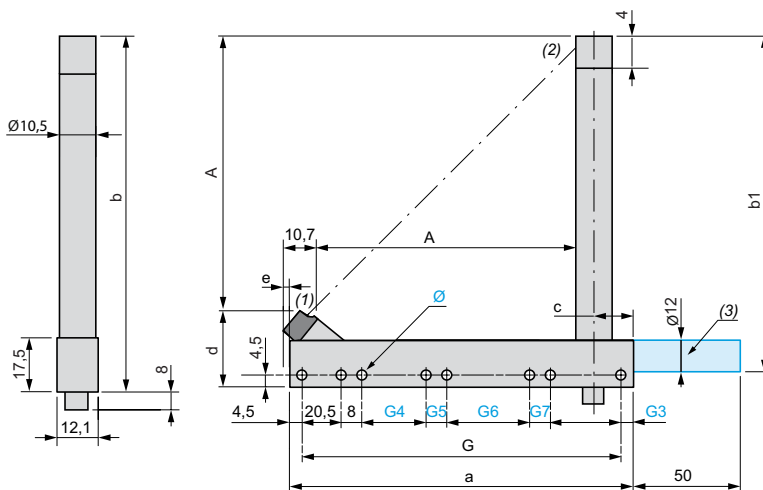

(1) Transmission LED  
(2) Yellow LED: output signal  
(3) Optional fixing rod available on request. Please consult our Customer Care Centre.

Type XUVR	Passageway A	Depth B	a	b	b1	G	G1	G2	G3	Ø					
XUVR0303●●●●●●	30	40	54	65.7	57.5	30	17	—	—	4 x 4.3					
XUVR0605●●●●●●	50	60	74	85.7	77.5	40	6.5	8	19.5	4 x 4.3					
XUVR0608●●●●●●	80	60	104	85.7	77.5	70	6.5	8	19.5	4 x 4.3					
XUVR01212●●●●●●	120	124.3	144	150.2	142	100	17	10	17	4 x 4.3					
XUVR01218●●●●●●	180	124.3	204	150.2	142	152	22	8	22	4 x 4.3					
Type XUVA	Type	Depth A	a	b	b1	G	G1	G2	G3	Ø	G4	G5	G6	G7	c
XUVA0505●●●●●●	50	44.3	75	83	75	66	—	—	4.5	4 x 4.3	—	—	—	—	14.75
XUVA0808●●●●●●	80	74.3	105	113	105	96	—	—	4.5	4 x 4.3	—	—	—	—	14.75
XUVA1212●●●●●●	120	112.3	145	154	146	136	—	—	4.5	4 x 4.3	—	—	—	—	19.75
XUVA1515●●●●●●	150	142.3	175	184	176	166	—	—	4.5	8 x 4.3	24	8	60	8	19.75

### Wiring schemes

#### M8 connector

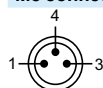

#### Pin n° - colour

- 1 BN
- 3 BU
- 4 BK

#### Cabling

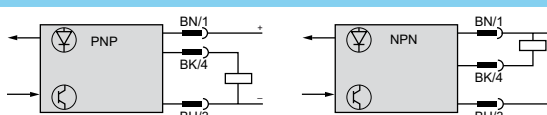

### Application examples

#### Vibrating bowl

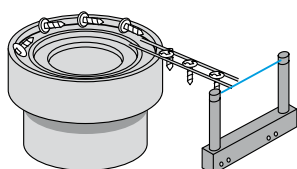

#### Monitoring height of objects passing on a conveyor

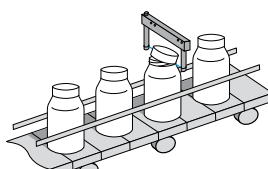

#### Detecting position of object on a conveyor

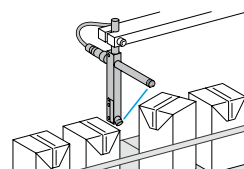

# Photo-electric sensors

OsiSense XU Application

Optical fork with teach mode

DC supply. Solid-state output

Optical fork with teach mode

+/- numeric potentiometer mode  
Green keypad

Teach mode  
Yellow keypad

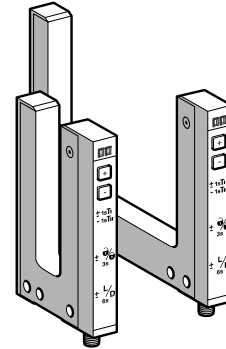
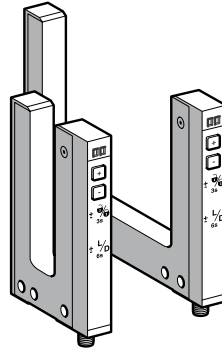

<b>System</b>	<b>Thru-beam</b>
<b>Type of transmission</b>	Infrared LED, modulated
<b>Nominal sensing distance (Sn)</b>	2...120 mm
<b>Minimum size of object detected</b>	Passageway 2...120 mm <b>0.2 mm</b>
<b>Fork type</b>	<b>XUYFNEP●</b>   <b>XUYFANEP●</b>

## References

4-wire, PNP/NPN independent outputs

NO/NC function, selectable

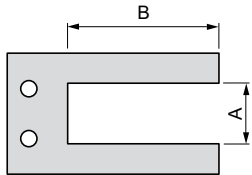

A = Passageway  
B = Depth

Passageway (A) mm	Depth (B)			Depth (B)		
	42	59	95	42	59	95
2	XUY FNEP40002	XUY FNEP60002	XUY FNEP100002	XUY FANEP40002	XUY FANEP60002	XUY FANEP100002
5	XUY FNEP40005	XUY FNEP60005	XUY FNEP100005	XUY FANEP40005	XUY FANEP60005	XUY FANEP100005
15	XUY FNEP40015	XUY FNEP60015	XUY FNEP100015	XUY FANEP40015	XUY FANEP60015	XUY FANEP100015
30	XUY FNEP40030	XUY FNEP60030	XUY FNEP100030	XUY FANEP40030	XUY FANEP60030	XUY FANEP100030
50	XUY FNEP40050	XUY FNEP60050	XUY FNEP100050	XUY FANEP40050	XUY FANEP60050	XUY FANEP100050
80	XUY FNEP40080	XUY FNEP60080	XUY FNEP100080	XUY FANEP40080	XUY FANEP60080	XUY FANEP100080
120	XUY FNEP40120	XUY FNEP60120	XUY FNEP100120	XUY FANEP40120	XUY FANEP60120	XUY FANEP100120

**Weight (kg)** 0.055 to 0.128 depending on model

## Characteristics

<b>Product certifications</b>	CE, cULus. This product is UL Listed if supplied by a class II or isolated supply delivering --- 30 V max. (isolated transformer for example) and protected by a UL fuse rated at 3A max.	
<b>Ambient air temperature</b>	For operation	- 20...+ 60 °C
	For storage	- 30...+ 80 °C
<b>Degree of protection</b>	Conforming to IEC 60529	IP 65
<b>Connection</b>	M8, 4-pin male connector (for 3-pin version please consult our Customer Care Centre)	
<b>Vibration resistance</b>	Conforming to IEC 60068-2-6	7 gn, amplitude ± 0.75 mm (f = 10 to 55 Hz)
<b>Shock resistance</b>	Conforming to IEC 60068-2-27	30 gn, duration 11 ms
<b>Materials</b>	Case	Painted aluminium and polyamide/glass
<b>Rated supply voltage</b>	--- 12...24 V with protection against reverse polarity	
<b>Voltage limits (including ripple)</b>	--- 10...30 V	
<b>Immunity to ambient light</b>	Natural light	10 000 lux
	Incandescent bulb	5000 lux
<b>Outputs</b>	PNP and NPN	By independent wire
	NO/NC	By programming
<b>Switching capacity</b>	<b>100 mA with overload and short-circuit protection</b>	
<b>Voltage drop, closed state</b>	< 2 V	
<b>Current consumption, no-load</b>	40 mA	
<b>Permissible capacitive load</b>	330 nF	
<b>Maximum switching frequency</b>	<b>10 kHz</b>	
<b>Response time</b>	Stability	+/- 20 µs
<b>Indicator lights</b>	Yellow LED	Output signal
	Red LED	Adjustment mode and keypad locking

Application: Detection of labels, detection of double sheet, detection of reference marks, detection on conveyor, detection on vibrating rail.

## Accessories

Description	Details	Length of cable (m)	References	Weight kg
<b>Pre-wired M8 connector</b>	Straight	2	<b>XZCP0941L2</b>	0.080
	Elbowed (90°)	2	<b>XZCP1041L2</b>	0.080
	Straight	5	<b>XZCP0941L5</b>	0.180
	Elbowed (90°)	5	<b>XZCP1041L5</b>	0.180

## Presentation

### XUYFNEP●●●

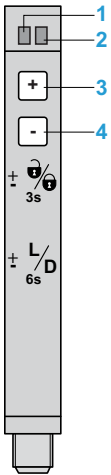

- 1 Yellow LED "ON": Output activated
- 2 Red LED "ON": Adjustments and keypad locking
- 3, 4 Sensitivity adjustment
- 3+4 Keypad locking (3 s ≤ press time < 6 s)
- 3+4 NO/NC (press time ≥ 6 s)

### XUYFANEP●●●

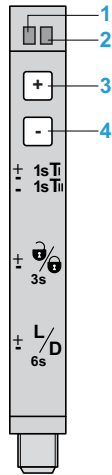

- 1 Yellow LED "ON": Output activated
- 2 Red LED "ON": Adjustments and keypad locking
- 3, 4 Sensitivity adjustment
- 3+4 Teach mode and automatic adjustment of sensitivity (press time < 3 seconds)
- 3+4 Keypad locking (3 s ≤ press time < 6 s)
- 3+4 NO/NC (press time ≥ 6 s)

## Dimensions

### XUYFNEP●●● / XUYFANEP●●●

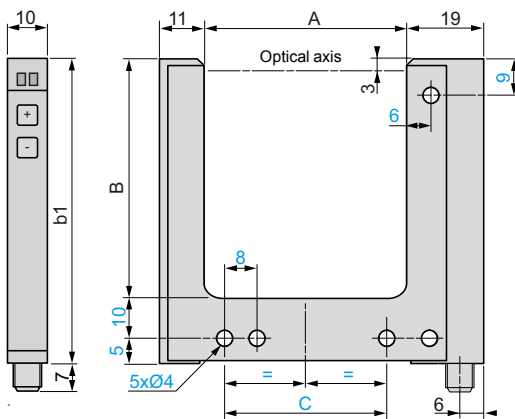

XUY	Passageway Depth		b1	C
	A	B		
FNEP/FANEP●002	2	42, 59, 95	57, 74, 110	14
FNEP/FANEP●005	5	42, 59, 95	57, 74, 110	14
FNEP/FANEP●015	15	42, 59, 95	57, 74, 110	27
FNEP/FANEP●030	30	42, 59, 95	57, 74, 110	42
FNEP/FANEP●050	50	42, 59, 95	57, 74, 110	40
FNEP/FANEP●080	80	42, 59, 95	57, 74, 110	70
FNEP/FANEP●120	120	42, 59, 95	57, 74, 110	110

## Wiring schemes

### Cabling



#### Pin n° - colour

- 1 BN: Brown
- 2 WH: White
- 3 BU: Blue
- 4 BK: Black

### M8 connector

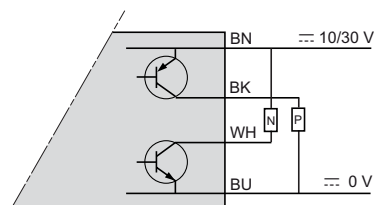

## Application examples

### Green keypad: Potentiometer mode

Detection of labels on belt

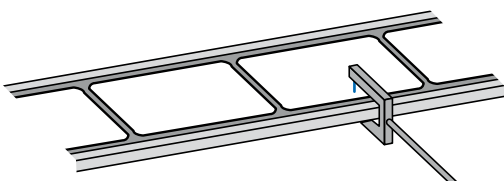

### Yellow keypad: Teach mode

Detection of sheet feed on printing machine

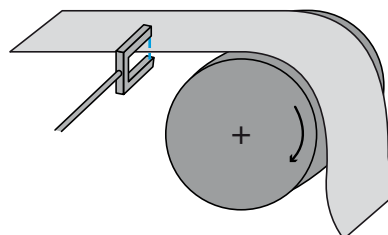

### High sensitivity fork range

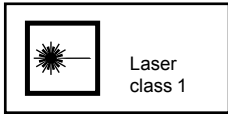

Laser class 1

Laser class 1, conforming to IEC 60825-1

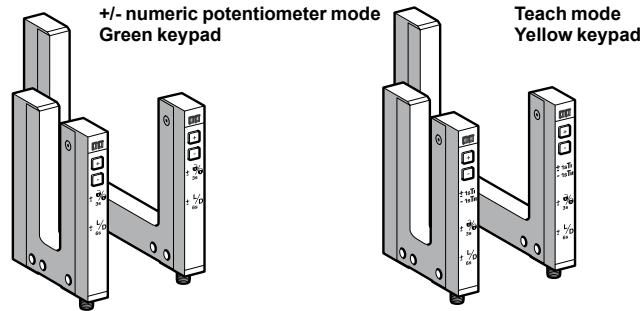

<b>System</b>	<b>Thru-beam</b>
<b>Type of transmission</b>	Red laser, modulated, class 1, wavelength: 670 nm
<b>Nominal sensing distance (Sn)</b>	2...120 mm
<b>Minimum size of object detected</b>	Passageway 2...120 mm 0.05 mm (repeat accuracy 0.01 mm)
<b>Fork type</b>	XUYFLNEP● XUYFALNEP●

### References

4-wire, PNP/NPN independent outputs NO/NC function, selectable

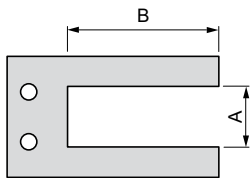

A = Passageway  
B = Depth

Passageway (A) mm	Depth (B)			Depth (B)		
	42	59	95	42	59	95
2	XUY FLNEP40002	XUY FLNEP60002	XUY FLNEP100002	XUY FALNEP40002	XUY FALNEP60002	XUY FALNEP100002
5	XUY FLNEP40005	XUY FLNEP60005	XUY FLNEP100005	XUY FALNEP40005	XUY FALNEP60005	XUY FALNEP100005
15	XUY FLNEP40015	XUY FLNEP60015	XUY FLNEP100015	XUY FALNEP40015	XUY FALNEP60015	XUY FALNEP100015
30	XUY FLNEP40030	XUY FLNEP60030	XUY FLNEP100030	XUY FALNEP40030	XUY FALNEP60030	XUY FALNEP100030
50	XUY FLNEP40050	XUY FLNEP60050	XUY FLNEP100050	XUY FALNEP40050	XUY FALNEP60050	XUY FALNEP100050
80	XUY FLNEP40080	XUY FLNEP60080	XUY FLNEP100080	XUY FALNEP40080	XUY FALNEP60080	XUY FALNEP100080
120	XUY FLNEP40120	XUY FLNEP60120	XUY FLNEP100120	XUY FALNEP40120	XUY FALNEP60120	XUY FALNEP100120

**Weight (kg)** 0.055 to 0.128 depending on model

### Characteristics

<b>Product certifications</b>	CE, cULus. This product is UL Listed if supplied by a class II or isolated supply delivering $\leq$ 30 V max. (isolated transformer for example) and protected by a UL fuse rated at 3 A max.	
<b>Ambient air temperature</b>	For operation	- 20...+ 50 °C
	For storage	- 30...+ 80 °C
<b>Degree of protection</b>	Conforming to IEC 60529	IP 65
<b>Connection</b>	M8, 4-pin male connector	
<b>Vibration resistance</b>	Conforming to IEC 60068-2-6	7 gn, amplitude $\pm$ 0.75 mm (f = 10 to 55 Hz)
<b>Shock resistance</b>	Conforming to IEC 60068-2-27	30 gn, duration 11 ms
<b>Materials</b>	Case	Painted aluminium and polyamide/glass
<b>Rated supply voltage</b>	$\leq$ 12...24 V with protection against reverse polarity	
<b>Voltage limits (including ripple)</b>	$\leq$ 10...30 V	
<b>Immunity to ambient light</b>	Natural light	10 000 lux
	Incandescent bulb	5000 lux
<b>Outputs</b>	PNP/NPN	By wiring
	NO/NC	Using teach mode
<b>Switching capacity</b>	100 mA with overload and short-circuit protection	
<b>Voltage drop, closed state</b>	< 2 V	
<b>Current consumption, no-load</b>	< 40 mA	
<b>Permissible capacitive load</b>	330 nF	
<b>Maximum switching frequency</b>	10 kHz	
<b>Response time</b>	+/- 20 $\mu$ s	
<b>Indicator lights</b>	Yellow LED: output signal; red LED: keypad locking and adjustments	

■ Applications: Detection of reference marks, detection on conveyor, detection on vibrating rail, detection of transparent object.

### Accessories

Description	Details	Length of cable (m)	References	Weight kg
Pre-wired M8 connector	Straight	2	XZCP0941L2	0.080
	Elbowed (90°)	2	XZCP1041L2	0.080
	Straight	5	XZCP0941L5	0.180
	Elbowed (90°)	5	XZCP1041L5	0.180

### Presentation

#### XUYFLNEP●

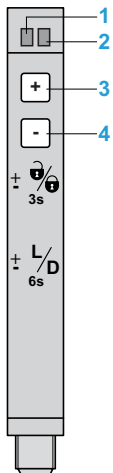

- 1 Yellow LED "ON":  
Output activated
- 2 Red LED "ON":  
Adjustments and keypad  
locking
- 3,4 Sensitivity adjustment
- 3+4 Keypad locking  
(3 s ≤ press time < 6 s)
- 3+4 NO/NC (press time ≥ 6 s)

#### XUYFALNEP●

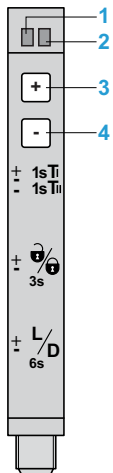

- 1 Yellow LED "ON":  
Output activated
- 2 Red LED "ON":  
Adjustments and keypad locking
- 3,4 Sensitivity adjustment
- 3+4 Teach mode and automatic adjustment of sensitivity  
(press time < 3 seconds)
- 3+4 Keypad locking (3 s ≤ press time < 6 s)
- 3+4 NO/NC (press time ≥ 6 s)

### Dimensions

#### XUYFLNEP●/XUYFALNEP●

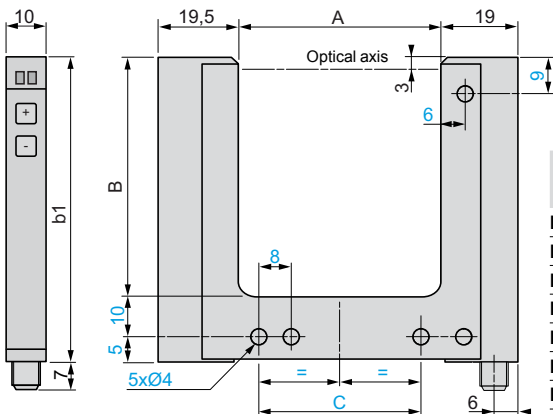

XUY	Passageway Depth		b1	C
	A	B		
FLNEP/FALNEP●2	2	42, 59, 95	57, 74, 110	14
FLNEP/FALNEP●5	5	42, 59, 95	57, 74, 110	14
FLNEP/FALNEP●15	15	42, 59, 95	57, 74, 110	27
FLNEP/FALNEP●30	30	42, 59, 95	57, 74, 110	42
FLNEP/FALNEP●50	50	42, 59, 95	57, 74, 110	40
FLNEP/FALNEP●80	80	42, 59, 95	57, 74, 110	70
FLNEP/FALNEP●120	120	42, 59, 95	57, 74, 110	110

### Wiring schemes

#### Cabling



#### Pin n° - colour

- 1 BN: Brown
- 2 WH: White
- 3 BU: Blue
- 4 BK: Black

#### M8 connector

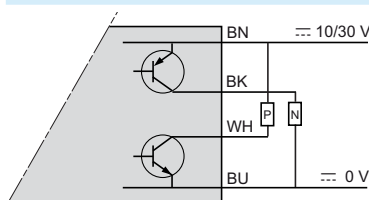

### Application examples

#### Green keypad: Potentiometer mode

Detection of an object exiting a vibrating bowl

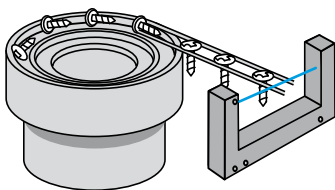

#### Yellow keypad: Teach mode

Detection of transparent bottles (glass, PET...)

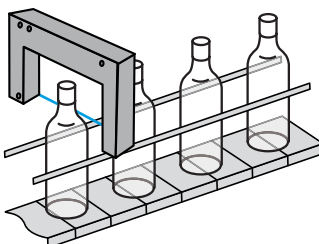

# Ultrasonic sensors

OsiSense XU Application, packaging series

For detection of transparent labels

DC supply. Solid-state output

## Fork design

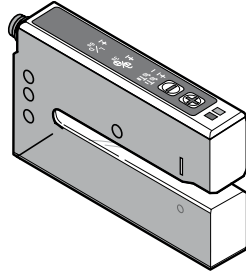

<b>System</b>	Thru-beam			
<b>Type of transmission</b>	Ultrasonic			
<b>Nominal sensing distance (Sn)</b>	3 mm			
<b>Depth</b>	69 mm			
<b>References</b>				
<b>4-wire</b>		<b>XUVU06M3KSNM8</b>	<b>XUVU06M3PSNM8</b>	<b>XUVU06M3NSNM8</b>
	NC or NO programmable function	PNP/NPN	PNP	NPN
<b>Remote adjustment</b>	No		Yes	
<b>Adjustment</b>	By numeric potentiometer (+/- buttons), static and dynamic teach modes.			
<b>Protection of settings</b>	By locking keypad			
<b>Weight (kg)</b>	0.130			

## Characteristics

<b>Product certifications</b>	CE, IEC 60947-5-2		
<b>Materials</b>	Aluminium case		
<b>Connection</b>	M8, 4-pin connector		
<b>Detection performance</b>	Minimum length of label	2 mm	
	Minimum distance between 2 labels	2 mm	
	Maximum flow rate	180 m/min	
	Detection accuracy	+/- 0.20 mm at 120 m/min	
<b>Supply</b>	Rated supply voltage	--- 12...24 V with protection against reverse polarity	
	Voltage limits	--- 10...30 V (including ripple)	
	Current consumption, no-load	45 mA	
	Residual voltage		
	At 100 mA	< 2 V	
	At 10 mA	< 1 V	
<b>Output</b>	Maximum rated current	100 mA with overload and short-circuit protection	
	Maximum switching frequency	1500 Hz	
	Indicator light		
	Output state	Yellow LED	
	Adjustment and keypad locking	Red LED	
<b>Delay</b>	300 µs, response and recovery		
<b>Environment</b>	Operating temperature	+ 5...+ 55° C	
	Storage temperature	- 20° C..+ 70° C	
	Degree of protection	IP 65	

## Function table

	Function	Thru-beam system	
		No label present in the beam (output inactive)	Label present in the beam (output active)
<b>Output state (PNP or NPN) indicator: yellow LED</b> (illuminated when sensor output is ON)	NC		
	NO		

## References of pre-wired connectors

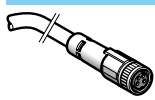

XZCP0941L●

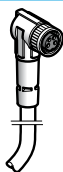

XZCP1041L●

Type of connector	For use with forks	Type	Cable length (m)	Reference	Weight kg
Female, M8, 4 pins	XUVU06M3KSNM8, XUVU06M3PSNM8, XUVU06M3NSNM8.	Straight	2	<b>XZCP0941L2</b>	0.080
			5	<b>XZCP0941L5</b>	0.180
		Elbowed	2	<b>XZCP1041L2</b>	0.080
			5	<b>XZCP1041L5</b>	0.180



# Ultrasonic sensors

OsiSense XU Application, packaging series

For detection of transparent labels

DC supply. Solid-state output

## Presentation (adjustment and indicators)

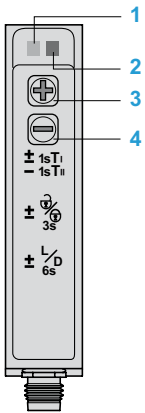

- 1 Yellow LED "ON": Output activated
- 2 Red LED "ON": Adjustments and keypad locking
- 3,4 Sensitivity adjustment
- 3+4 Teach mode and automatic adjustment of sensitivity (press time < 3 seconds)
- 3+4 Keypad locking (3 s ≤ press time < 6 s)
- 3+4 NO/NC (press time ≥ 6 s)

## Connections

### Connector



### Pin no. - colour

- 1 BN: Brown
- 2 WH: White (remote teaching)
- 3 BU: Blue
- 4 BK: Black

### Wiring schemes

#### PNP/NPN: XUVU06M3KSNM8

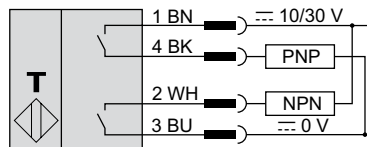

#### PNP: XUVU06M3PSNM8

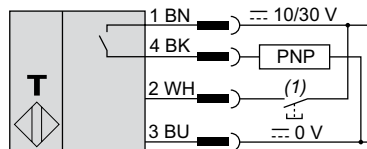

(1) Remote teaching.

#### NPN: XUVU06M3NSNM8

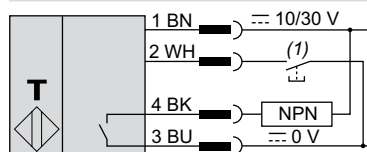

(1) Remote teaching.

## Application example

Detection of transparent labels on opaque or transparent strip

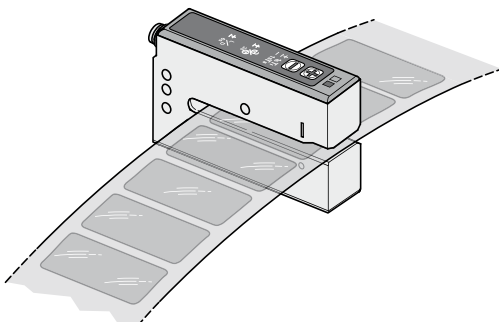

## Dimensions (in mm)

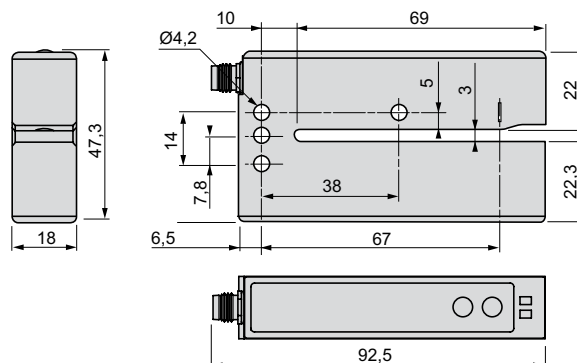

# Photo-electric sensors

OsiSense XUVE Application, packaging series  
Optical fork for detection of opaque labels  
DC supply. Solid-state output

## Fork design

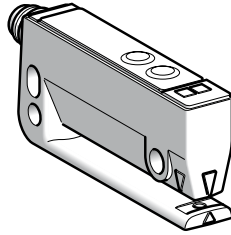

<b>System</b>	Thru-beam						
<b>Type of transmission</b>	Infrared						
<b>Nominal sensing distance (Sn)</b>	3 mm						
<b>Depth</b>	40 mm						
<b>References</b>							
<b>4-wire</b>	<table border="1"> <tr> <td><b>XUVE04M3KSNM8</b></td> <td><b>XUVE04M3PSNM8</b></td> <td><b>XUVE04M3NSNM8</b></td> </tr> <tr> <td>NO or NC programmable function</td> <td>PNP</td> <td>NPN</td> </tr> </table>	<b>XUVE04M3KSNM8</b>	<b>XUVE04M3PSNM8</b>	<b>XUVE04M3NSNM8</b>	NO or NC programmable function	PNP	NPN
<b>XUVE04M3KSNM8</b>	<b>XUVE04M3PSNM8</b>	<b>XUVE04M3NSNM8</b>					
NO or NC programmable function	PNP	NPN					
<b>Remote adjustment</b>	No						
<b>Adjustment</b>	By numeric potentiometer (+/- buttons) and red LED						
<b>Protection of settings</b>	By locking keypad						
<b>Weight (kg)</b>	0.035						

## Characteristics

<b>Product certifications</b>	CE, cULus												
<b>Material</b>	Thermoplastic case (PA12)												
<b>Connection</b>	M8, 4-pin connector												
<b>Detection performance</b>	<table border="1"> <tr> <td>Minimum length of label</td> <td>2 mm</td> </tr> <tr> <td>Minimum distance between 2 labels</td> <td>2 mm</td> </tr> <tr> <td>Maximum flow rate</td> <td>200 m/min</td> </tr> <tr> <td><b>Detection accuracy</b></td> <td><b>+/- 50 µm at 150 m/min</b></td> </tr> </table>	Minimum length of label	2 mm	Minimum distance between 2 labels	2 mm	Maximum flow rate	200 m/min	<b>Detection accuracy</b>	<b>+/- 50 µm at 150 m/min</b>				
Minimum length of label	2 mm												
Minimum distance between 2 labels	2 mm												
Maximum flow rate	200 m/min												
<b>Detection accuracy</b>	<b>+/- 50 µm at 150 m/min</b>												
<b>Supply</b>	<table border="1"> <tr> <td>Rated supply voltage</td> <td>12...24 V with protection against reverse polarity</td> </tr> <tr> <td>Voltage limits</td> <td>10...30 V ~ (including ripple)</td> </tr> <tr> <td>Current consumption, no-load</td> <td>35 mA</td> </tr> <tr> <td>Residual voltage at 100 mA</td> <td>&lt; 2 V</td> </tr> </table>	Rated supply voltage	12...24 V with protection against reverse polarity	Voltage limits	10...30 V ~ (including ripple)	Current consumption, no-load	35 mA	Residual voltage at 100 mA	< 2 V				
Rated supply voltage	12...24 V with protection against reverse polarity												
Voltage limits	10...30 V ~ (including ripple)												
Current consumption, no-load	35 mA												
Residual voltage at 100 mA	< 2 V												
<b>Output</b>	<table border="1"> <tr> <td>Maximum rated current</td> <td>100 mA with overload and short-circuit protection</td> </tr> <tr> <td><b>Maximum switching frequency</b></td> <td><b>10 kHz</b></td> </tr> <tr> <td>Indicator lights</td> <td></td> </tr> <tr> <td>    Output state</td> <td>Yellow LED</td> </tr> <tr> <td>    Adjustment and keypad locking</td> <td>Red LED</td> </tr> <tr> <td>Delay (response and recovery)</td> <td>50 µs</td> </tr> </table>	Maximum rated current	100 mA with overload and short-circuit protection	<b>Maximum switching frequency</b>	<b>10 kHz</b>	Indicator lights		Output state	Yellow LED	Adjustment and keypad locking	Red LED	Delay (response and recovery)	50 µs
Maximum rated current	100 mA with overload and short-circuit protection												
<b>Maximum switching frequency</b>	<b>10 kHz</b>												
Indicator lights													
Output state	Yellow LED												
Adjustment and keypad locking	Red LED												
Delay (response and recovery)	50 µs												
<b>Environment</b>	<table border="1"> <tr> <td>Operating temperature</td> <td>- 20...+ 60°C</td> </tr> <tr> <td>Storage temperature</td> <td>- 30...+ 80°C</td> </tr> <tr> <td>Degree of protection</td> <td>IP 65</td> </tr> </table>	Operating temperature	- 20...+ 60°C	Storage temperature	- 30...+ 80°C	Degree of protection	IP 65						
Operating temperature	- 20...+ 60°C												
Storage temperature	- 30...+ 80°C												
Degree of protection	IP 65												

## Function table

	Function	Thru-beam system	
		No label present in the beam (output inactive)	Label present in the beam (output active)
Output state (PNP or NPN) indicator: yellow LED (illuminated when sensor output is ON)	NC		
	NO		

## References of pre-wired connectors

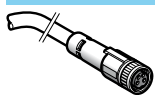

XZCP0941L●

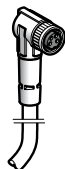

XZCP1041L●

Type of connector	For use with forks	Type	Cable length (m)	Reference	Weight kg
Female, M8, 4 pins	XUVE04M3KSNM8, XUVE04M3PSNM8, XUVE04M3NSNM8,	Straight	2	<b>XZCP0941L2</b>	0,080
			5	<b>XZCP0941L5</b>	0,180
		Elbowed	2	<b>XZCP1041L2</b>	0,080
			5	<b>XZCP1041L5</b>	0,180

# Photo-electric sensors

OsiSense XUVE Application, packaging series  
Optical fork for detection of opaque labels  
DC supply. Solid-state output

## Presentation (adjustment and indicators)

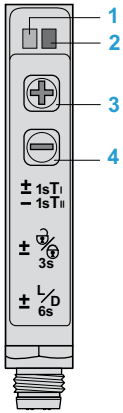

- 1 Yellow LED "ON": Output activated
- 2 Red LED "ON": Adjustments and keypad locking
- 3,4 Sensitivity adjustment
- 3+4 Teach mode and automatic adjustment of sensitivity (press time < 3 seconds)
- 3+4 Keypad locking (3 s ≤ press time < 6 s)
- 3+4 NO/NC (press time ≥ 6 s)

## Connections

### Connector



### Pin no. - colour

- 1 **BN**: Brown
- 2 **WH**: White (remote teaching)
- 3 **BU**: Blue
- 4 **BK**: Black

### Wiring schemes

#### PNP/NPN: XUVE04M3KSNM8

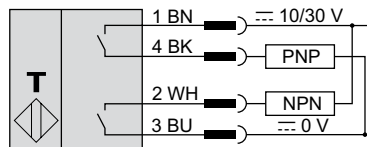

#### PNP: XUVE04M3PSNM8

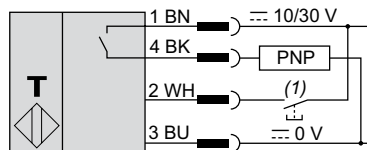

(1) Remote teaching.

#### NPN: XUVE04M3NSNM8

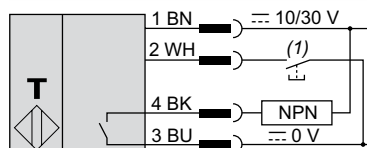

(1) Remote teaching.

## Dimensions

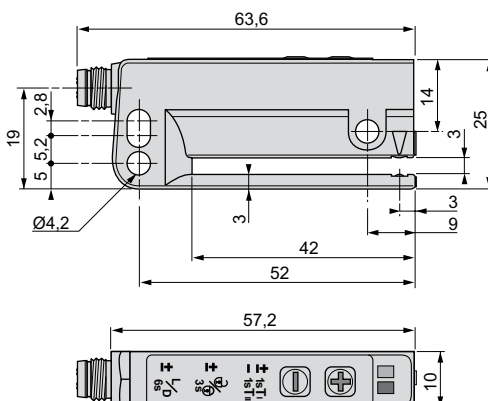

## Application example

Detection of opaque labels before application to a package

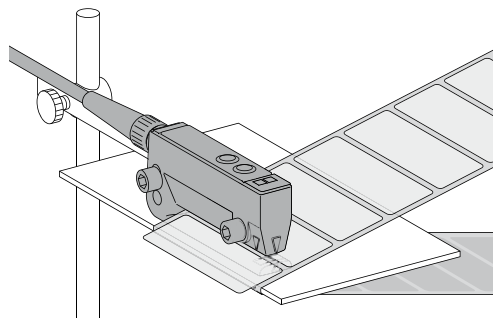

# Photo-electric sensors

OsiSense XU Application, packaging series

For detection of labels (1)

DC supply. Solid-state output

## Fork design

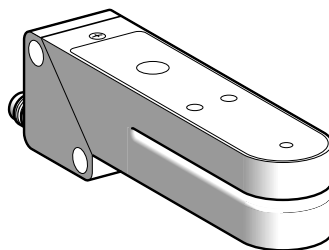

System	Thru-beam	
Type of transmission	Infrared	Red/green
Nominal sensing distance (Sn)	2 mm	

## References

3-wire, PNP and NPN	NO or NC programmable function (2)	<b>XUVK0252S</b>	<b>XUVK0252VS</b>
Weight (kg)	0.120		

## Characteristics

Product certifications	CE	
Ambient air temperature	For operation: 0...+55 °C. For storage: -20...+70 °C	
Vibration resistance	Conforming to IEC 60068-2-6	Amplitude ±1.5 mm up to 55 Hz, 7 gn (f = 10...55 Hz)
Shock resistance	Conforming to IEC 60068-2-27	30 gn, duration 11 ms
Degree of protection	Conforming to IEC 60529	IP 65
Connection	M8 connector (suitable female connectors)	
Materials	Case: zinc alloy; lenses: glass	
Rated supply voltage	≡ 12...24 V with protection against reverse polarity	
Voltage limits	≡ 10...30 V (including ripple)	
Switching capacity (sealed)	≤ 100 mA with overload and short-circuit protection	
Voltage drop, closed state	≤ 1.5 V	
Output clamping resistor	10 kΩ	
Current consumption, no-load	≤ 50 mA	
Maximum switching frequency	25 kHz	
Delays	First-up: ≤ 30 ms; response < 100 μs; recovery < 100 μs	
Indicator lights	Output state	Yellow LED
	Sensor ready	Green LED
	Read error	Red LED

Function table	Function	Thru-beam system	
		No label present in the beam	Label present in the beam
Output state (PNP or NPN) indicator: yellow LED (illuminated when sensor output is ON)	NC		
	NO		

(1) Applications: the infrared transmission beam sensor **XUVK0252S** is suitable for the detection of all types of opaque labels; the red/green transmission sensor **XUVK0252VS** is suitable for the detection of all types of labels of different colours.

(2) This sensor is adjustable using teach mode: the NC or NO function is selected when performing the first stage of teaching for setting-up the sensor (see programming using teach mode, page 67).

# Photo-electric sensors

OsiSense XU Application, packaging series

For detection of labels

DC supply. Solid-state output

## Presentation

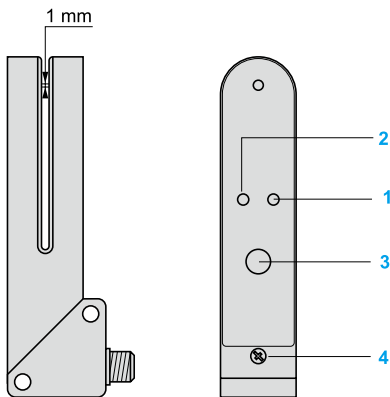

## Programming using teach mode

- Place the label to be detected in the beam of the optical fork. Press the SET button and hold down until the green LED 2 goes out,
- When the green LED 2 flashes, the detector has "learnt" the label. Following this, place the backing to which the label is affixed in the beam of the optical fork. Press the SET button and hold down until the green LED 2 goes out,
- When the green LED 2 illuminates as a steady light teaching is completed and the sensor is ready for operation.

- 1 Yellow LED, output state indicator
- 2 Dual colour green/red LED, Ready/Error
- 3 Teach mode programming SET button
- 4 Locking screw

## Dimensions

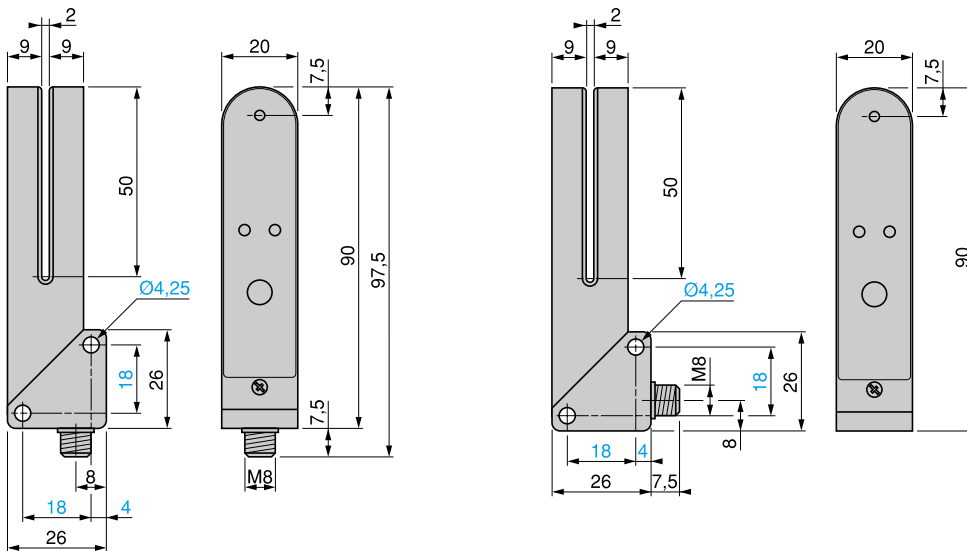

## Connector scheme (sensor connector pin view)

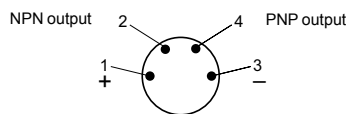

# Photo-electric sensors

OsiSense XU Application, packaging series  
Optical fork with teach mode  
For detection of labels  
DC supply. Solid-state output

## Fork design

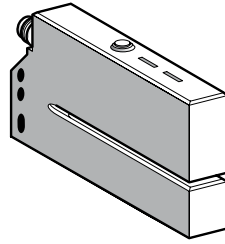

<b>System</b>		Thru-beam	
<b>Type of transmission</b>		Infrared, continuous	
<b>Nominal sensing distance (Sn)</b> (Passageway)		3 mm	5 mm
<b>References</b>			
<b>4-wire, PNP and NPN</b>	NO or NC programmable function (1) Automatic adjustment using teach mode	<b>XUYFA983003COS</b>	<b>XUYFA983005COS</b>
<b>Weight (kg)</b>		0.07	0.07
<b>Characteristics</b>			
<b>Product certifications</b>		CE, cULus	
<b>Ambient air temperature</b>	For operation	- 20...+ 60 °C	
	For storage	- 30...+ 80 °C	
<b>Degree of protection</b>	Conforming to IEC 60529	IP 65	
<b>Connection</b>		M8, 4-pin connector (for pre-cabled version please consult our Customer Care Centre)	
<b>Materials</b>		Anodised aluminium	
<b>Rated supply voltage</b>		≡ 12...24 V with protection against reverse polarity	
<b>Voltage limits</b> (including ripple)		≡ 10...30 V	
<b>Switching capacity</b> (sealed)		≤ 100 mA with overload and short-circuit protection	
<b>Immunity to ambient light</b>	Natural light	3000 lux	
	Incandescent bulb	3000 lux	
<b>Voltage drop, closed state</b>		< 2 V	
<b>Current consumption, no-load</b>		40 mA	
<b>Maximum switching frequency</b>		10 kHz	
<b>Delays</b>		Response: 50 µs; recovery: 50 µs	
<b>Indicator lights</b>		Green LED: no object present Red LED: keypad locking and adjustments.	

Function table	Function	Thru-beam system	
		No label present in the beam	Label present in the beam
<b>Output state (PNP or NPN) indicator: green LED</b> (illuminated when sensor output is ON)	NC		
	NO		

(1) By reversing supply connections.

# Photo-electric sensors

OsiSense XU Application, packaging series

Optical fork with teach mode

For detection of labels

DC supply. Solid-state output

## Presentation (adjustment and indicators)

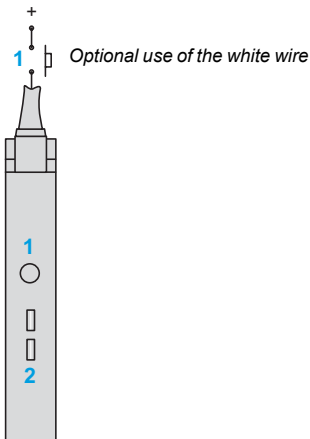

Teaching is performed on the item to which the label is affixed

- 1 Teach mode button
  - 1 press: standard teaching (red LED flashes for 2 s)
  - 2 presses: fine teaching (green LED flashes for 2 s)
  - 1 prolonged press: keypad locking (red LED on)
- 2 Red LED and green LED flash: short-circuit or object too opaque.

## Dimensions

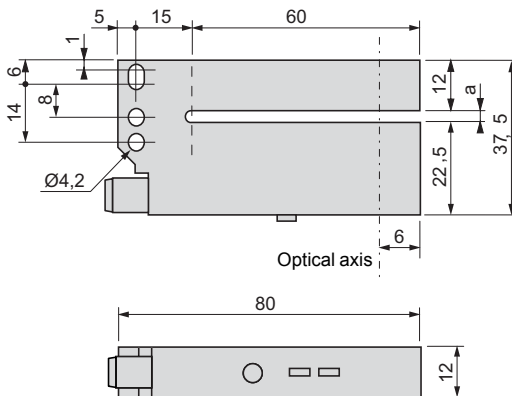

Reference	a (passageway)
XUYFA98●●●3COS	3
XUYFA98●●●5COS	5

## Wiring schemes (sensor connector pin view)

### Connector

#### Pin n° - colour

- 1 BN: Brown
- 2 WH: White (input)
- 3 BU: Blue
- 4 BK: Black (PNP and NPN outputs)

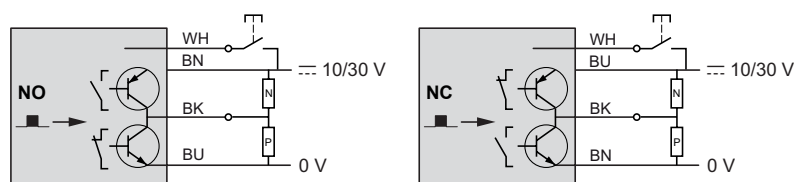

■ → Object detected  
If the white wire is not used, connect to 0 V.

## Application examples

### Detection of overlapping envelopes

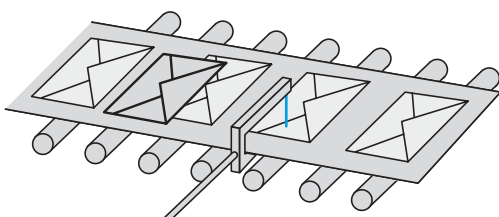

### Detection of labels on belt

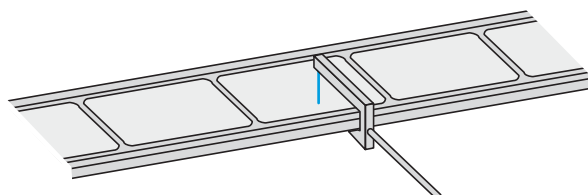

# Photo-electric sensors

OsiSense XU Application, material handling series

Optical fork with integrated amplifier

DC supply. Solid-state output

## Fork design

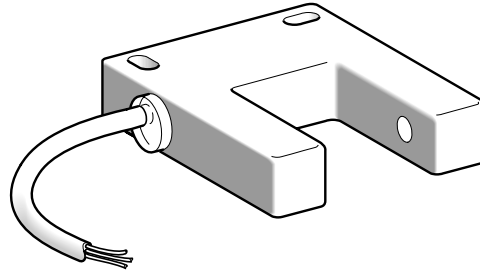

<b>System</b>	Thru-beam
<b>Type of transmission</b>	Infrared
<b>Nominal sensing distance (Sn)</b>	30 mm

## References

<b>3-wire, PNP</b>	NO function	XUVH0312
<b>3-wire, NPN</b>	NO function	XUVJ0312
<b>Weight (kg)</b>	0.130	

## Characteristics

<b>Product certifications</b>	CE	
<b>Ambient air temperature</b>	For operation	- 5...+ 55 °C
	For storage	- 20...+ 70 °C
<b>Vibration resistance</b>	Conforming to IEC 60068-2-6	Amplitude ±1 mm up to 42 Hz, 7 gn (f = 10...42 Hz)
<b>Shock resistance</b>	Conforming to IEC 60068-2-27	30 gn, duration 11 ms
<b>Degree of protection</b>	Conforming to IEC 60529	IP 54
<b>Connection</b>	Pre-cabled: diameter 5 mm, length 2 m, wire c.s.a.: 3 x 0.34 mm <sup>2</sup>	
<b>Materials</b>	Case	PC/ABS
	Lenses	PMMA
	Cable	PvR
<b>Rated supply voltage</b>	≡ 24 V with protection against reverse polarity	
<b>Voltage limits</b>	≡ 19...38 V (including ripple)	
<b>Switching capacity (sealed)</b>	≤ 150 mA with overload and short-circuit protection	
<b>Voltage drop, closed state</b>	≤ 1.5 V	
<b>Current consumption, no-load</b>	≤ 20 mA	
<b>Maximum switching frequency</b>	1000 Hz	
<b>Delays</b>	First-up	≤ 30 ms
	Response	500 μs
	Recovery	500 μs

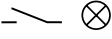
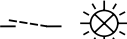
Function table	Function	Thru-beam system	Object present in the beam
<b>NO function</b> Output state (PNP or NPN) indicator: red LED (illuminated when sensor output is ON)	NO	No object present in the beam 	



## Detection curve

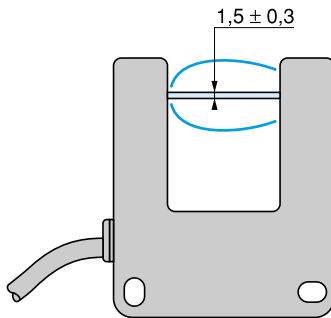

## Dimensions

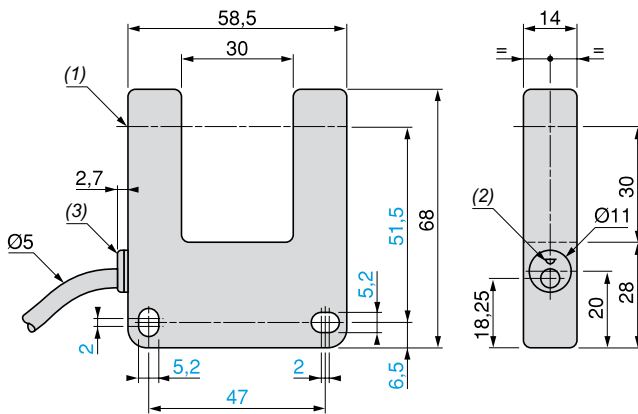

(1) Optical axis

(2) Red LED

(3) Diffuser

Max. tightening torque of fixing screws: 3 N.m

## Wiring schemes (3-wire ...)

### NO function

#### PNP output

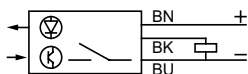

#### NPN output

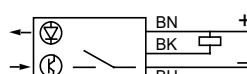

# Photo-electric sensors

OsiSense XU Application, conveying series

Dynamic/static detection of passage of objects (1)

For detecting and counting parts

DC supply. Solid-state output

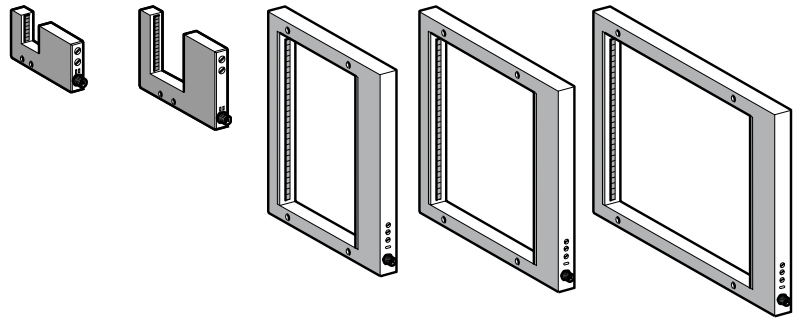

<b>System</b>		<b>Thru-beam</b>				
<b>Type of transmission</b>		<b>Infrared</b>				
<b>Passageway dimensions</b>		<b>30 x 30 mm</b>	<b>60 x 60 mm</b>	<b>200 x 120 mm</b>	<b>200 x 180 mm</b>	<b>200 x 250 mm</b>
<b>References</b>						
<b>4-wire, PNP or NPN</b> NO or NC programmable function	Minimum size of object detected					
	Dynamic mode	Static mode				
	Ø 2 mm	–	<b>XUVF30M8</b>	<b>XUVF60M8</b>	–	–
	Ø 4 mm	Ø 6 mm	–	–	<b>XUVF120M12</b>	<b>XUVF180M12</b>
	Ø 10 mm	Ø 15 mm	–	–	<b>XUYFRS120S</b>	<b>XUYFRS180S</b>
<b>Weight (kg)</b>			0.080	0.140	0.860	1.000
					1.120	

## References of U shape frames

Open (U shape) frames for sizes 120, 180 and 250 mm are also available.

To order an open frame, add the letter **U** to the end of the reference. Example: XUVF120M12 becomes **XUVF120M12U**.

## Characteristics

<b>Product certifications</b>	CE, cULus	
<b>Ambient air temperature</b>	For operation: 0...+60°C. For storage: -20...+80°C	
<b>Vibration resistance</b>	7 gn, amplitude ± 1 mm (f = 10...55 Hz), conforming to IEC 60068-2-6	
<b>Shock resistance</b>	30 gn, duration 11 ms, conforming to IEC 60068-2-27	
<b>Degree of protection</b>	Conforming to IEC 60529	IP 65
<b>Connection</b>	M8 connector (suitable female connectors, including pre-wired versions, refer to our "OsiSense XZ" catalogue)	M12 connector (suitable female connectors, including pre-wired versions, please refer to our "Cabling accessories OsiSense XZ" catalogue)
<b>Materials</b>	Case Lenses	Painted aluminium Polycarbonate Altuglass
<b>Immunity to ambient light</b>	Sunlight: 4000 lux max. Incandescent light: 400 lux max.	Sunlight: 10,000 lux max. Incandescent light: 3000 lux max.
<b>Passing speed of object</b>	Min.: 10 cm/s, max.: 15 m/s (Ø 2 mm object)	Min (2): 10 cm/s, max.: 15 m/s (Ø 4 mm object) or max.: 70 m/s (Ø 10 mm object)
<b>Rated supply voltage</b>	<b>24 V <math>\overline{\text{---}}</math> with protection against reverse polarity</b>	
<b>Voltage limits</b>	18...30 V $\overline{\text{---}}$ (including ripple)	
<b>Switching capacity (sealed)</b>	<b>≤ 100 mA with overload and short-circuit protection</b>	
<b>Voltage drop, closed state</b>	< 2 V	
<b>Current consumption, no-load</b>	≤ 120 mA	≤ 150 mA
<b>Maximum switching frequency</b>	500 Hz	5000 Hz
<b>Delays</b>	Response: < 1 ms Recovery: < 1 ms	Response: < 0.1 ms Recovery: < 0.1 ms
<b>Time delay</b>	Off-delay (reset): adjustable between 0 and 5 seconds	

Function table	Function	Thru-beam system	
		No object present in the beam	Passage of object through the beam
Output state (PNP or NPN) and orange LED: illuminated when sensor output is ON.	NC		
	NO		

(1) XUVF●● sensors are suitable for detecting the passage of all types of objects (both metal and plastic), of any shape and colour.

XUVF120M12, XUVF180M12 and XUVF250M12 frames can be used:

- In dynamic mode for counting parts or monitoring the passing of parts on injection moulding machines.

- In static mode for detecting bar or cable type moving or non-moving parts, entering machines (maintain the signal).

(2) The min. value only applies to dynamic mode.

# Photo-electric sensors

OsiSense XU Application, conveying series

Dynamic/static detection of passage of objects

For detecting and counting parts

DC supply. Solid-state output

## Presentation

- 1 Sensitivity adjustment potentiometer
  - 2 Time delay adjustment potentiometer (XUV only)
  - 3 Indicators:
    - Orange LED:
      - For XUVF30M8 and XUVF60M8: object in the beam
      - For XUVF120M12, XUVF180M12, XUVF250M12, XUVFRS120S, XUVFRS180S and XUVFRS250S: closed state of the contact
    - Red LED: solid state output overload or short-circuit (flashing)
  - 4 Notes concerning XUVF30M8 and XUVF60M8:
    - In the event of a supply malfunction, the red LED flashes
    - In the event of a short-circuit on the output, both the red and orange LEDs flash
- Dynamic mode (NO or NC) or static mode (NO or NC) selector switch

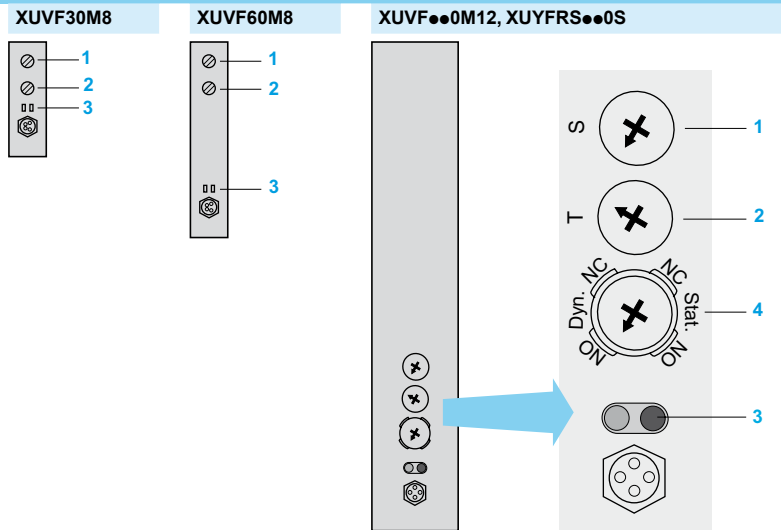

## Dimensions

### XUVF30M8

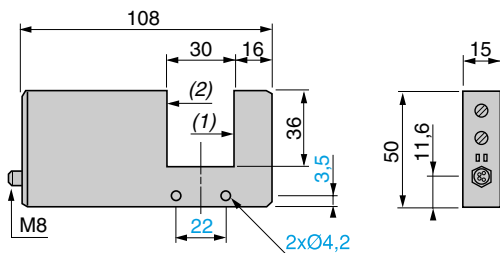

### XUVF60M8

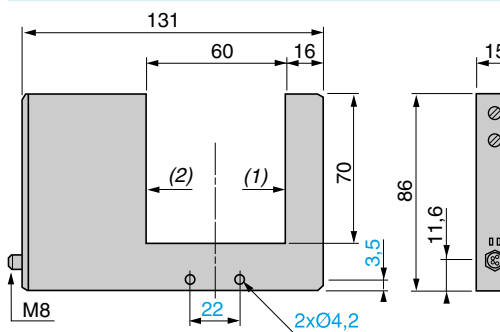

### XUVF...0M12, XUVFRS...0S

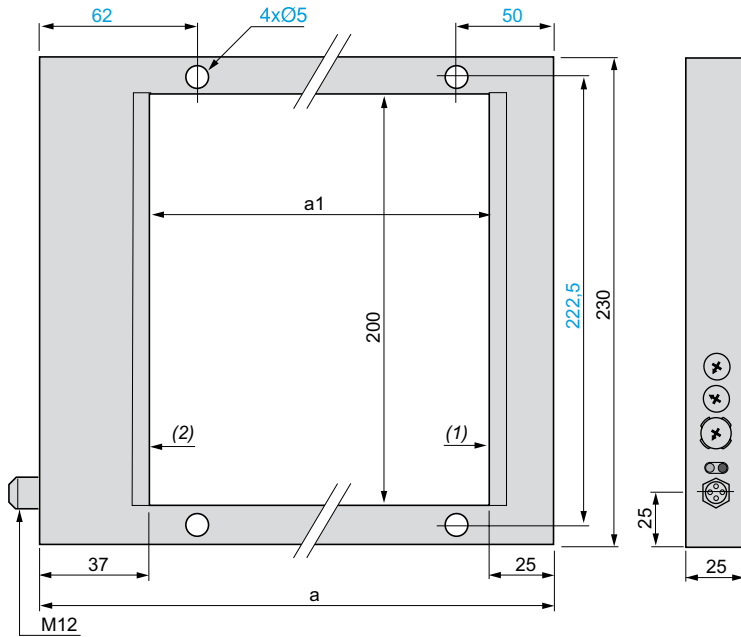

- (1) Transmitting face  
(2) Reception face

Reference	Reference	a	a1
XUVF120M12	XUVFRS120S	182	120
XUVF180M12	XUVFRS180S	242	180
XUVF250M12	XUVFRS250S	312	250

## Connections

### Wiring schemes (4-wire ~)

#### PNP output

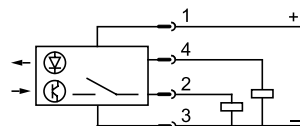

#### NPN output

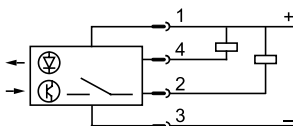

### Connector scheme (sensor connector pin view)

#### XUVF30M8 and XUVF60M8

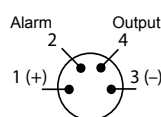

#### XUVF120M12, XUVFRS120S, XUVF180M12, XUVFRS180S, XUVF250M12 and XUVFRS250S

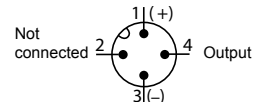

**Note:** For XUVF30M8 and XUVF60M8 only, the alarm (2) triggers in the event of an object stopping within the beam. For XUVF30M8 and XUVF60M8, the NC output is gained by connecting terminal 3 to (+) and terminal 1 to (-).

# Photo-electric sensors

OsiSense XU Application, packaging series  
Compact design, 50 x 50  
Colour mark readers <sup>(1)</sup>  
DC supply. Solid-state output

**Compact design, 50 x 50**

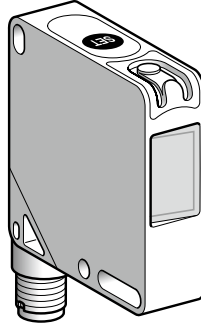

System	Diffuse
Type of transmission	White LED (400-700 nm)
Nominal sensing distance (Sn)	19 mm

**References**

Description	Reference
3-wire, PNP or NPN	PNP output XUKR1PSMM12
	NPN output XUKR1NSMM12
Weight (kg)	0.045

**Characteristics**

Product certifications	CE, cULus
Ambient air temperature	For operation: - 10...+ 55 °C For storage: - 20...+ 70 °C
Vibration resistance	Conforming to IEC 60068-2-6 Amplitude ± 0.5 mm, f = 10...55 Hz for each axis
Shock resistance	Conforming to IEC 60068-2-27 30 gn, duration 11 ms, 6 shocks on each axis
Degree of protection	Conforming to IEC 60529 IP 67
Connection	M12, 4-pin connector; can be set at 90°
Materials	Case: ABS Lenses: Glass (window tilted, anti-reflective glass)
Spot diameter	At 19 mm: Ø 3.5 mm
Resolution	0.5 mm
Depth of field	± 2 mm
Adjustment	Teach mode using button or remotely using "remote" wire
Indicator lights	Output: Yellow LED Stability: Green LED: Ready Flashing green/red: error
Rated supply voltage	DC 12...24 V
Voltage limits	DC 10...30 V (including ripple)
Switching capacity (sealed)	≤ 100 mA with protection against reverse polarity, overload and short-circuit
Voltage drop, closed state (saturation voltage)	≤ 2 V
Current consumption, no-load	≤ 30 mA
Maximum linear speed of mark	2.5 m/s for 1 mm wide mark
Maximum switching frequency	5 kHz
Delay	100 µs for response and recovery
Time delay	Time delay function: Minimum time output active: 20 ms Auxiliary functions: Remote teaching via "remote" wire; teach mode button locking Operating mode: Standard teaching: output activated on dark mark

(1) Applications: detection of contrasting colours on reflective, matt or embossed surfaces. Colour mark and index mark reading function on automated packaging and filling systems and on labelling, heat sealing, thermo-forming and printing machines, etc.

# Photo-electric sensors

OsiSense XU Application, packaging series  
Compact design, 50 x 50  
Colour mark readers  
DC supply. Solid-state output

## Presentation

### Description

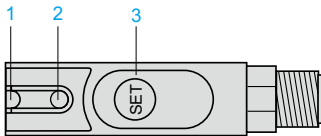

- 1 Output LED
- 2 Dual colour stability LED
- 3 SET button

### Detection zone and spot size

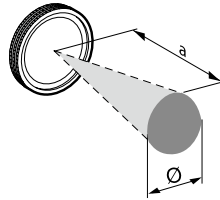

	a (mm)	Ø (mm)
XUKR1•SMM12	19	3.5

### Detection curve

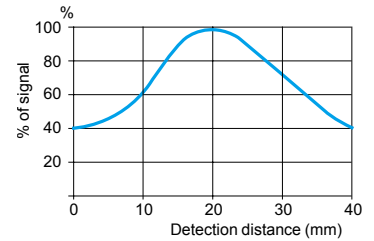

## Fixing accessories

Description	Reference	Weight kg
<b>Metal fixing bracket</b> (2 screws, 2 nuts and 2 washers included)	<b>XUZK2000</b>	0.040
<b>Metal fixing bracket</b> (2 screws, 2 nuts, 2 washers and 1 screwdriver included)	<b>XUZA51</b>	0.050

## Dimensions

### XUKR1•SMM12

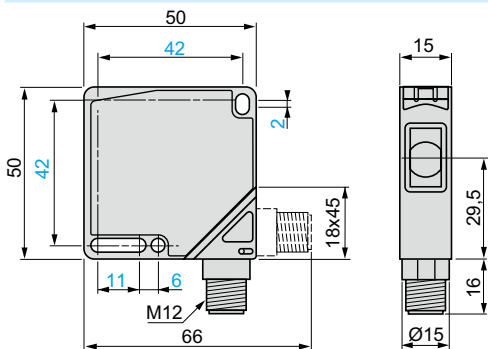

### Fixing bracket XUZK2000

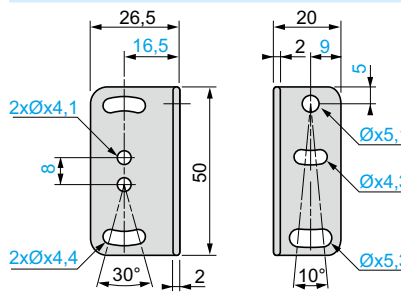

### Fixing bracket XUZA51

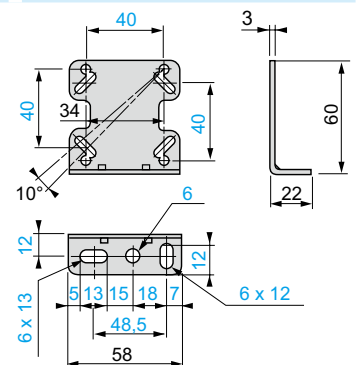

## Schemes

### Connector scheme

#### Sensor connector pin view

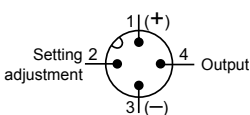

### Wiring schemes

Automatic NC or NO selection depending on chronological order of teaching for the mark and the background.

#### PNP output

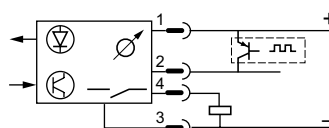

#### NPN output

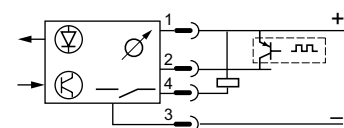

Pin N°	Type	Colour
1	10...30 V	Brown
2	Adjustment input (1)	White
3	0 V	Blue
4	Output	Black

(1) Connecting the "Remote" adjustment input to + VDC is equivalent to pressing the SET button.

**Colour mark reading using plastic fibre optic**

Remote reading by coaxial fibre optic

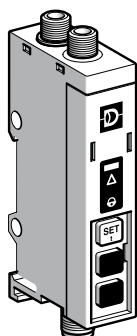

<b>System</b>	<b>Diffuse</b>
<b>Type of transmission</b>	White LED (450 - 650 nm)
<b>Nominal sensing distance (Sn)</b>	<b>18 mm with fibre optic XUYFPDC61/101</b> <b>4 mm with fibre optic XUYFPDCM861/M8101</b>

**References**

<b>4-wire, PNP/NPN output</b>	NO/NC function	<b>XUYDCFCO966S (1)</b>
<b>Weight (kg)</b>		0.047

**Characteristics**

<b>Product certifications</b>		CE
<b>Ambient air temperature</b>	For operation	0...+ 40 °C
	For storage	- 20...+ 80 °C
<b>Degree of protection</b>	Conforming to IEC 60529	IP 65
<b>Connection</b>		M8 male connector
<b>Materials</b>	Case	Polyamide
	Lens	Polyamide
<b>Rated supply voltage</b>		<b>--- 24 V</b>
<b>Spot diameter</b>		1.5 mm
<b>Modulation frequency</b>		40 kHz
<b>Depth of field</b>		FPDC: + 7/- 5 mm Black/White, + 1/- 3 mm Grey/White FPDCM8: ± 1 mm
<b>Adjustment</b>		By teaching background and mark
<b>Voltage limits</b> (including ripple)		<b>--- 10...30 V with protection against reverse polarity</b>
<b>Immunity to ambient light</b>	Incandescent bulb	10 000 lux
	Natural light	20 000 lux
<b>Switching capacity</b>		<b>100 mA with overload and short-circuit protection</b>
<b>Voltage drop, closed state</b>		< 2 V
<b>Current consumption, no-load</b>		50 mA
<b>Maximum switching frequency</b>		<b>20 kHz</b>
<b>Delays</b>	Response and recovery	25 µs
<b>Output state indication</b>		LED

**Accessories**

(1) Sensor XUYDCFCO966S only operates with fibres XUYFPDC●●●● and XUYFPDCM8●●●, to be ordered separately.

Description	Details	Length of fibre	Length of cable	References	Weight
		mm	m		
<b>Integrated fibre optic</b> to be ordered at the same time as the amplifier	M18	600	–	<b>XUYFPDC61</b>	0.100
		1000	–	<b>XUYFPDC101</b>	0.115
	M8	600	–	<b>XUYFPDCM861</b>	0.060
		1000	–	<b>XUYFPDCM8101</b>	0.075
<b>Pre-wired M8 connector</b>	Straight	–	2	<b>XZCP0941L2</b>	0.080
	Elbowed (90°)	–	2	<b>XZCP1041L2</b>	0.080
	Straight	–	5	<b>XZCP0941L5</b>	0.180
	Elbowed (90°)	–	5	<b>XZCP1041L5</b>	0.180

# Photo-electric sensors

OsiSense XU Application, packaging series

Colour mark readers

With teach mode

DC supply. Solid-state output

## Presentation

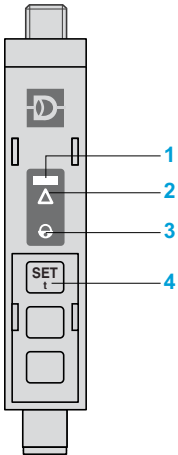

- 1 Detection of the lightest shade
- 2 Programming assistance
- 3 Alarm/press button
- 4 Programming button

## Dimensions

XUYDCFCO966S

Mounting on 35 mm rail

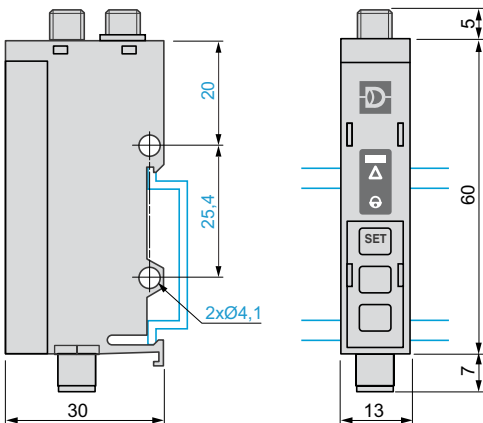

XUYFPDC●●●●●

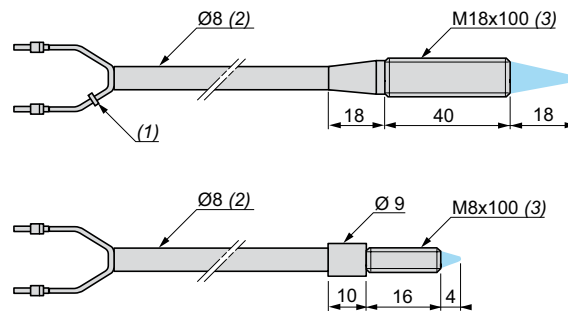

- (1) The ring indicates that the fibre is transmitting.
- (2) Bend radius: 15 mm.
- (3) 2 nuts included with fibre optic.

## Wiring schemes

Cabling

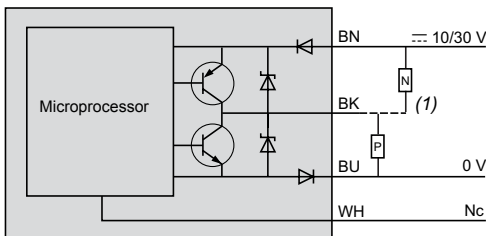

M8 connector



Pin n° - colour

1 BN: Brown

2 WH: White

3 BU: Blue

4 BK: Black

- (1) High level on first shade "taught".
- Nc: Not connected

# Photo-electric sensors

OsiSense XU Application, packaging series  
Colour mark readers (1)  
DC supply. Solid-state output

Compact design

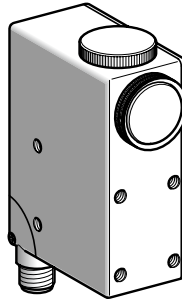

<b>System</b>	<b>Diffuse</b>
<b>Type of transmission</b> (line of sight along case axis or at 90° depending on position of lens)	Red or green, automatically selected when using teach mode
<b>Nominal sensing distance</b> (Sn)	<b>9 mm (7 mm with XURZ02 or 18 mm with XURZ01) (2)</b>
<b>Sensitivity adjustment</b>	Automatic when using teach mode

References

<b>3-wire, PNP or NPN programmable</b>	NO or NC programmable function (3)	<b>XURK1KSMM12</b>
<b>Weight</b> (kg)		0.550

Characteristics

<b>Product certifications</b>	CE
<b>Ambient air temperature</b>	For operation: - 10...+ 55 °C. For storage: - 20...+ 70 °C
<b>Vibration resistance</b>	Conforming to IEC 60068-2-6 7 gn, amplitude ± 0.6 mm (f = 10...55 Hz)
<b>Shock resistance</b>	Conforming to IEC 60068-2-27 30 gn, duration 11 ms
<b>Degree of protection</b>	Conforming to IEC 60529 IP 67
<b>Connection</b>	M12 connector, can be set at 3 positions (suitable female connectors, including pre-wired versions, refer to our "Cabling accessories OsiSense XZ" catalogue)
<b>Materials</b>	Case: zinc alloy; lenses: glass
<b>Spot dimensions</b>	At 9 mm: 1.5 x 5 mm (with lens <b>XURZ0</b> see table on page 79)
<b>Minimum detectable width of mark</b>	0.5 mm
<b>Maximum vertical inclination of reader</b>	20°
<b>Maximum linear speed of mark</b>	10 m/s (for 1 mm wide mark)
<b>Rated supply voltage</b>	<b>12...24 V with protection against reverse polarity</b>
<b>Voltage limits</b>	10...30 V (including ripple)
<b>Switching capacity</b> (sealed)	<b>≤ 200 mA with overload and short-circuit protection</b>
<b>Voltage drop, closed state</b>	≤ 1 V (NPN); ≤ 2 V (PNP)
<b>Current consumption, no-load</b>	≤ 80 mA
<b>Maximum switching frequency</b>	10 kHz
<b>Delays</b>	First-up: ≤ 100 ms; response: ≤ 50 µs; recovery: ≤ 50 µs
<b>Time delay</b>	"OFF delay": 20 ms, activated/deactivated by internal switch
<b>Analogue output</b>	0...5.5 V (voltage proportional to light reflected by the object)

Function table	Function	Detection of dark mark on light background		Function	Detection of light mark on dark background	
		No mark present in the beam	Mark present in the beam		No mark present in the beam	Mark present in the beam
<b>Output state (PNP or NPN) indicator: red LED</b> (illuminated when sensor output is ON)	NC			NO		
	NO			NC		

(1) Applications: detection of contrasting colours on reflective, matt or embossed surfaces. Colour mark and index mark reading function on automated packaging and filling systems and on labelling, heat sealing, thermo-forming and printing machines, etc.  
 (2) Lenses for reduction or magnification of spot (see page 165 and spot size table on page 79).  
 (3) Automatic programming depending on chronological order of teaching for the mark and the background.



## XURK1KSMM12

Detection zone and spot size  
(mm)

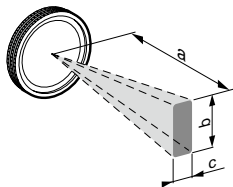

XUR	a	b	c
K●●●●●●●●	9	5	1.5
K●●●●●●●● + XURZ01	18	7	2
K●●●●●●●● + XURZ02	7	4	1

Lenses XURZ0●, see page 165

Detection curve

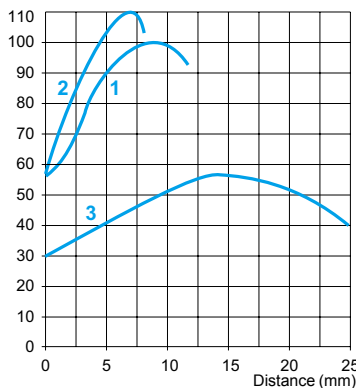

- 1 XURK●●●●●●●●
- 2 XURK●●●●●●●● + XURZ02
- 3 XURK●●●●●●●● + XURZ01

Vertical inclination

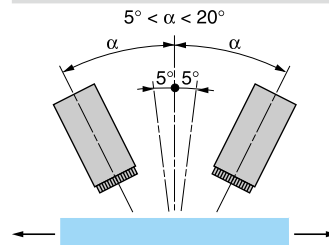

An angle of 5 to 10° from vertical is recommended for reflective or transparent surfaces.  
Maximum vertical inclination: 20°.

## Dimensions

XURK1KSMM12

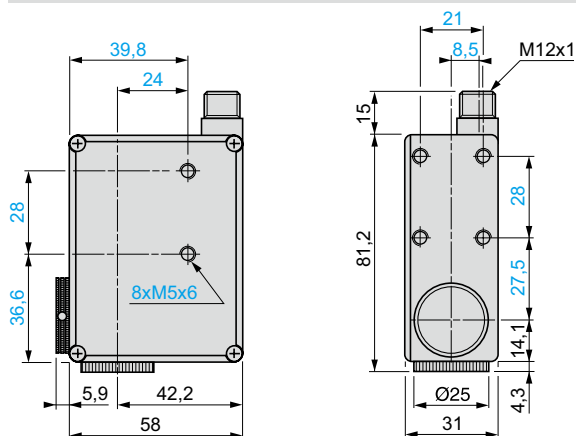

## Wiring schemes (3-wire ---)

XURK1KSMM12

Automatic NC or NO selection depending on chronological order of teaching for the mark and the background

PNP output

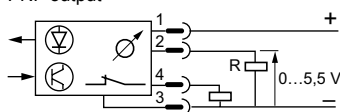

NPN output

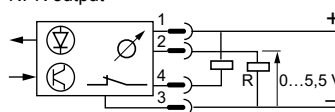

R = 2.2 kΩ

Connector scheme

(sensor connector  
pin view)

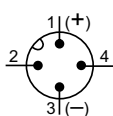

Functions

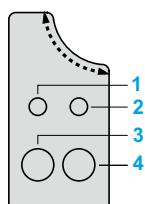

- 1 Green LED, sensor in teach mode
- 2 Red LED, output state
- 3 Teach mode button for mark
- 4 background

PNP/NPN programming  
and time delay by internal switches

# Photo-electric sensors

OsiSense XU Application, packaging series

Luminescence sensor <sup>(1)</sup>

DC supply. Solid-state output

## Design 18

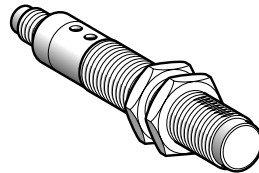

<b>System</b>		<b>Diffuse</b>
<b>Type of transmission</b>		Ultraviolet (370 nm)
<b>Nominal sensing distance (Sn)</b>		<b>20 mm</b> for colour mark reading, <b>0...80 mm</b> in diffuse mode
<b>Sensitivity adjustment</b>		By potentiometer
<b>References</b>		
<b>3-wire, PNP</b>	NO function (2)	<b>XU5M18U1D</b>
<b>Weight (kg)</b>		0.075
<b>Characteristics</b>		
<b>Product certifications</b>		CE, CSA, UL
<b>Ambient air temperature</b>	For operation	- 25...+ 55 °C
	For storage	- 40...+ 70 °C
<b>Vibration resistance</b>	Conforming to IEC 60068-2-6	7 gn, amplitude ± 0.6 mm (f = 10...55 Hz)
<b>Shock resistance</b>	Conforming to IEC 60068-2-27	30 gn, duration 11 ms
<b>Degree of protection</b>	Conforming to IEC 60529	IP 67
<b>Connection</b>		M12 connector (suitable female connectors, including pre-wired versions)
<b>Materials</b>	Case	Nickel plated brass
	Lenses	PMMA
<b>Spot diameter</b>		At 20 mm: Ø 3 x 1 mm
<b>Auxiliary functions</b>		External synchronisation, locking
<b>Indicator lights</b>	Output state	Green LED
	Teach mode	—
<b>Rated supply voltage</b>		<b>--- 12...24 V with protection against reverse polarity</b>
<b>Voltage limits</b>		--- 10...30 V (including ripple)
<b>Switching capacity (sealed)</b>		<b>≤ 100 mA</b> <b>with protection against reverse polarity, overload and short-circuit</b>
<b>Voltage drop, closed state</b>		≤ 1.5 V (PNP)
<b>Current consumption, no-load</b>		≤ 20 mA
<b>Maximum switching frequency</b>		1 kHz
<b>Delays</b>	First-up	≤ 100 ms
	Response	≤ 500 µs
	Recovery	≤ 500 µs
<b>Time delay</b>		"OFF delay": 20 ms, activated/deactivated by cabling method

(1) Applications: detection of invisible reference marks, markings, glues or varnishes containing bluing agents.

(2) Output activated when a blued mark on a non blued background is present.

## Curves

### XU5M18U1D

#### Detection curves

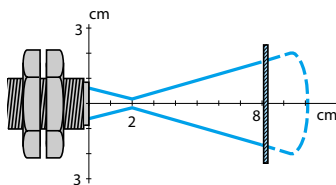

Object 5 x 5 cm, white 90%  
Spot size at 20 mm: oval,  $\varnothing$  3 x 1 mm

#### Vertical inclination

$$5^\circ < \alpha < 20^\circ$$

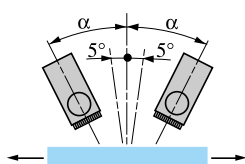

An angle of 5 to 10° from vertical is recommended for reflective or transparent surfaces  
Maximum vertical inclination: 20°

## Dimensions

### XU5M18U1D

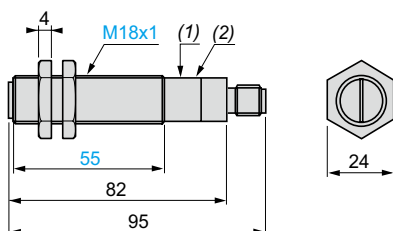

(1) Potentiometer  
(2) Green LED  
Fixing nut tightening torque: 15 N.m.

## Wiring schemes

### XU5M18U1D

#### Connector scheme

(Sensor connector pin view)

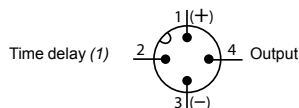

#### Wiring schemes (3-wire ...)

PNP output  
Without output signal time delay

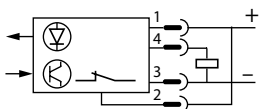

With output signal time delay (20 ms)

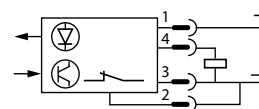

(1) "OFF delay" of output signal:  
- no time delay: connect contact 2 to (+)  
- 20 ms time delay: connect contact 2 to (-)

## Photo-electric sensors

OsiSense XU Application, packaging series  
Detection of illumination using plastic fibre optic  
and teach mode  
Four-wire DC. Solid-state output

### Fibre design

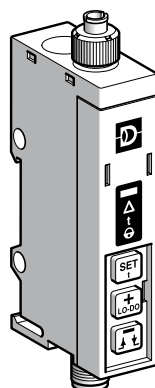

Nominal sensing distance (Sn) | Depending on fibre optic used

### References

4-wire, PNP/NPN output | NO/NC programmable function | XUYAFLC0966S

Weight (kg) | 0.054

### Characteristics

Product certifications		CE
Ambient air temperature	For operation	0...+60 °C
	For storage	-20...+80 °C
Degree of protection	Conforming to IEC 60529	IP 65
Connection		M8, 4-pin male connector
Materials	Case	Polycarbonate
Rated supply voltage		12...24 V with protection against reverse polarity
Voltage limits (including ripple)		10...30 V
Switching capacity		100 mA with overload and short-circuit protection
Voltage drop, closed state		2 V
Current consumption, no-load		< 40 mA
Maximum switching frequency		< 5 Hz
External input	Active	< 1.4 V
	Inactive	> 3 V
Delays	Response and recovery	< 100 ms
Output time delay	Range	0...5 s in 11 adjustment increments
	Duration of each increment	First increment 40 ms then 500 ms for each press
Indicator lights	Output signal	Green LED
	Limit of detection	Red LED
	Time delay active	Red LED
Sensitivity adjustment		Using teach (fine mode or standard mode) Adjustment possible using +/- button Remote teaching using external input (fine mode)

### ■ Applications

- Verifying operation of indicator lights on electrical appliances
- Testing car headlights on production line

### Accessories

Description	Details	Length of cable	References	Weight
		m		kg
Plastic fibre optic (1)	Ø 2.2 mm	1	XUYA005	0.007
Pre-wired M8 connector	Straight	2	XZCP0941L2	0.080
	Elbowed (90°)	2	XZCP1041L2	0.080
	Straight	5	XZCP0941L5	0.180
	Elbowed (90°)	5	XZCP1041L5	0.180

(1) End fitting, see page 148.

# Photo-electric sensors

OsiSense XU Application, packaging series

Detection of illumination using plastic fibre optic  
and teach mode

Four-wire DC. Solid-state output

## Presentation

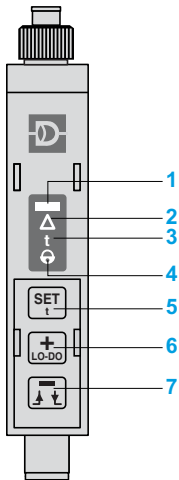

- 1 Output signal
- 2 Limit of detection  
Positioning assistance
- 3 Time delay active
- 4 Action keypad  
Keypad locking
- 5 Automatic adjustment of threshold  
Access to special functions
- 6 Sensitivity increase  
NO/NC output  
Time delay increase
- 7 Sensitivity decrease  
On-delay, Off-delay inversion  
Time delay decrease

## Dimensions

Mounting on 35 mm  $\perp$  rail

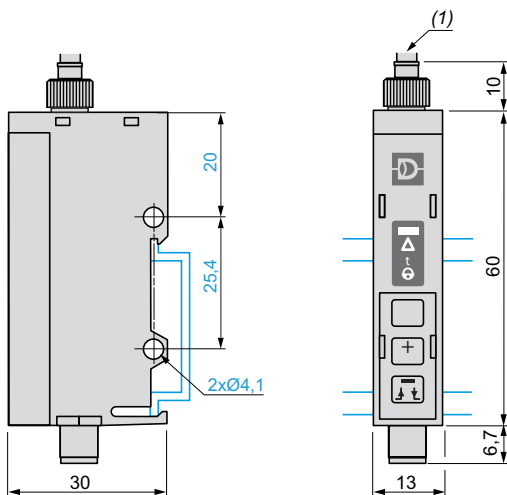

(1)  $\varnothing$  2.2 mm plastic fibre optic.

## Wiring schemes

Scheme

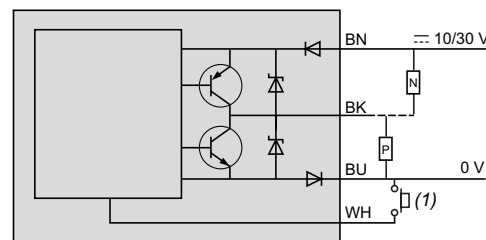

M8 connector

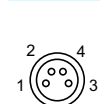

Pin n° - colour

- 1 BN: Brown
- 2 WH: White
- 3 BU: Blue
- 4 BK: Black

(1) Remote teaching. If not used: connect to +.

## Application examples

Verifying operation of car headlights on an assembly line

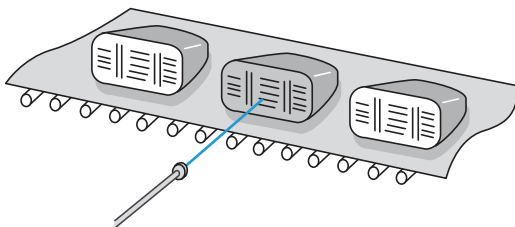

Verifying operation of indicator lights on electrical appliances

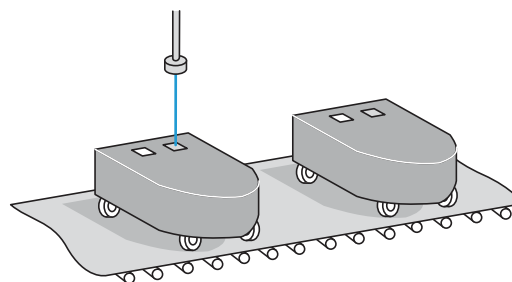

# Photo-electric sensors

OsiSense XU Application, packaging series

For detection of transparent materials

Design 18, plastic or stainless steel

Three-wire DC, solid-state output

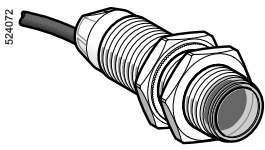

XUBT●●●NL2

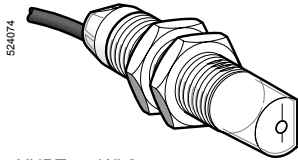

XUBT●●●WL2

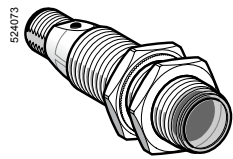

XUBT●●●NM12

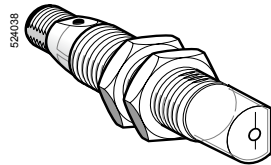

XUBT●●●WM12

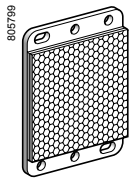

XUZC50

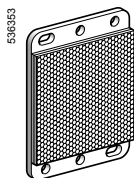

XUZC50HP

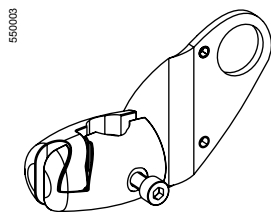

XUZB2003

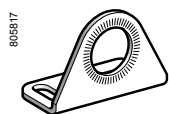

XUZA118

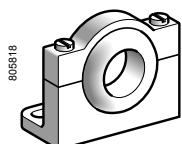

XUZA218

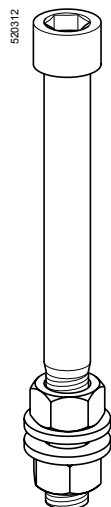

XUZ2001

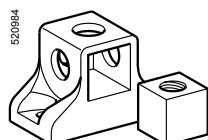

XUZ2003

## Ø 18 plastic, coaxial polarised reflex with teach mode

Sensing distance (Sn) m	Function	Line of sight	Output	Reference	Weight kg
<b>Pre-cabled (2)</b>					
0...1.4	NO or NC, by programming	Along case axis	PNP	<b>XUBTAPSNL2 (1)</b>	0.110
	With reflector		NPN	<b>XUBTANSNL2 (1)</b>	0.110
XUZC50/C50HP					
0...0.8	NO or NC, by programming	90° to case axis	PNP	<b>XUBTAPSWL2 (1)</b>	0.113
	With reflector		NPN	<b>XUBTANSWL2 (1)</b>	0.113
XUZC50/C50HP					
<b>M12 connector</b>					
0...1.4	NO or NC, by programming	Along case axis	PNP	<b>XUBTAPSNM12 (1)</b>	0.045
	With reflector		NPN	<b>XUBTANSNM12 (1)</b>	0.045
XUZC50/C50HP					
0...0.8	NO or NC, by programming	90° to case axis	PNP	<b>XUBTAPSWM12 (1)</b>	0.048
	With reflector		NPN	<b>XUBTANSWM12 (1)</b>	0.048
XUZC50/C50HP					

## Ø 18 stainless steel, coaxial polarised reflex with teach mode

Sensing distance (Sn) m	Function	Line of sight	Output	Reference	Weight kg
<b>Pre-cabled (2)</b>					
0...1.4	NO or NC, by programming	Along case axis	PNP	<b>XUBTSPSNL2 (1)</b>	0.135
	With reflector		NPN	<b>XUBTSNSNL2 (1)</b>	0.135
XUZC50/C50HP					
0...0.8	NO or NC, by programming	90° to case axis	PNP	<b>XUBTSPSWL2 (1)</b>	0.138
	With reflector		NPN	<b>XUBTSNSWL2 (1)</b>	0.138
XUZC50/C50HP					
<b>M12 connector</b>					
0...1.4	NO or NC, by programming	Along case axis	PNP	<b>XUBTSPSNM12 (1)</b>	0.070
	With reflector		NPN	<b>XUBTSNSNM12 (1)</b>	0.070
XUZC50/C50HP					
0...0.8	NO or NC, by programming	90° to case axis	PNP	<b>XUBTSPSWM12 (1)</b>	0.073
	With reflector		NPN	<b>XUBTNSWM12 (1)</b>	0.073
XUZC50/C50HP					

## Ø 18 plastic, reflex with teach mode

Sensing distance (Sn) m	Function	Line of sight	Output	Reference	Weight kg
<b>Pre-cabled (2)</b>					
0.1...0.8	NO or NC, by programming	Along case axis	PNP	<b>XUBT1PSNL2</b>	0.103
	With reflector		NPN	<b>XUBT1NSNL2</b>	0.103
XUZC50					
<b>M12 connector</b>					
0.1...0.8	NO or NC, by programming	Along case axis	PNP	<b>XUBT1PSNM12</b>	0.045
	With reflector		NPN	<b>XUBT1NSNM12</b>	0.045
XUZC50					

## Accessories for XUBT●●●●● (3)

Description	Dimensions	Reference	Weight kg
Universal reflector	50 x 50 mm	<b>XUZC50</b>	0.020
Application reflector (accuracy, detection sensitivity)	50 x 50 mm	<b>XUZC50HP</b>	0.020

## Fixing accessories (4)

Description	Reference	Weight kg
3D fixing kit for use on M12 rod, for XUBT or XUZC50/C50HP	<b>XUZB2003</b>	0.170
M12 rod	<b>XUZ2001</b>	0.050
Support for M12 rod	<b>XUZ2003</b>	0.150
Stainless steel fixing bracket	<b>XUZA118</b>	0.045
Plastic fixing bracket with adjustable ball-joint	<b>XUZA218</b>	0.035

(1) Application reflector **XUZC50HP** included with sensor.

(2) For a 5 m long cable, replace L2 by L5.

Example: **XUBTAPSNL2** becomes **XUBTAPSNL5**.

(3) For further information, see page 162.

(4) For further information, see page 164.

# Photo-electric sensors

OsiSense XU Application, packaging series

For detection of transparent materials

Design 18, plastic or stainless steel

Three-wire DC, solid-state output

Characteristics		XUBT●●●●M12/XUBT●●●●L2	XUBT1●●●●M12/XUBT1●●●●L2
Sensor type		UL, CSA, CE	
Product certifications		UL, CSA, CE	
Connection	Connector	M12 (male)	
	Pre-cabled	Length: 2 m, wire c.s.a.: 3 x 0.34 mm <sup>2</sup>	
Nominal sensing distance Sn	Line of sight along case axis	m	0 to 1.4 with reflector XUZC50/C50HP   0.1 to 0.8 with reflector XUZC50
	Line of sight 90° to case axis	m	0 to 0.8 with reflector XUZC50/C50HP   -
Beam divergence		1.5° (Ø 37mm spot at 1.4 m)	
Blind zone		m	0   0.1
Preferred object approach direction		Any   Lenses on horizontal plane for horizontal passage of object	
Type of transmission		Coaxial polarised red   Dual lens red	
Degree of protection		Conforming to IEC 60529   IP 65, IP 67, double insulation □ IP 69K for connector version XUBT●●●●M12 (1)	
Temperature	Storage	°C	- 40...+ 70
	Operation	°C	0...+ 55
Materials	Case	XUBTA and XUBT1 ●●●●●: plastic PBT XUBTS●●●●●: stainless steel (grade 304Cu)	
	Lens	PMMA	
	Cable	PvR	
Vibration resistance	Conforming to IEC 60068-2-6	7 gn, amplitude ± 1 mm (f = 10 to 55 Hz)	
Shock resistance	Conforming to IEC 60068-2-27	30 gn, duration 11 ms	
Indicator lights	Output state	Yellow LED	
	Supply on	Green LED	
	Stability	Red LED   Red LED for alignment only	
Rated supply voltage		V	--- 12...24 with protection against reverse polarity
Voltage limits (including ripple)		V	--- 10...32
Current consumption, no-load		mA	45   30
Switching capacity		mA	≤ 100 with overload and short-circuit protection
Voltage drop, closed state		V	≤ 1.5
Maximum switching frequency		Hz	1000   250
Delays	First-up	ms	< 200   < 200
	Response and recovery	µs	< 500   < 2000

(1) IP69K also available with PVC cable, please consult our Customer Care Center for specific adaptation.

## Wiring schemes

### M12 connector

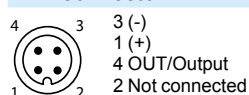

### Pre-cabled

(-) BU (Blue)  
(+) BN (Brown)  
OUT/Output BK (Black)

### PNP

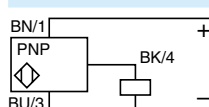

### NPN

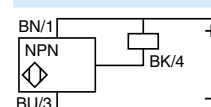

## Detection curves

### With reflector XUZC50●●

Line of sight along case axis | Line of sight 90° to case axis

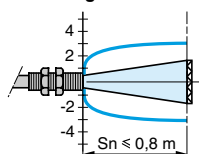
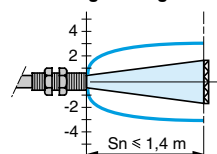

Sn ≤ 1.4 m (XUBT)  
Sn ≤ 0. m (XUBT1)

Sn ≤ 0,8 m (XUBT only)

## Dimensions

### XUBT●●●●

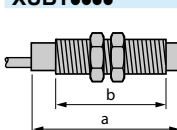

	Pre-cabled (mm)		Connector (mm)	
	a	b	a	b
Ø 18, line of sight along case axis	64	44	78	44
Ø 18, line of sight 90° to case axis	78	44	92	44

## Setting-up

### Recommended distances and application restraints

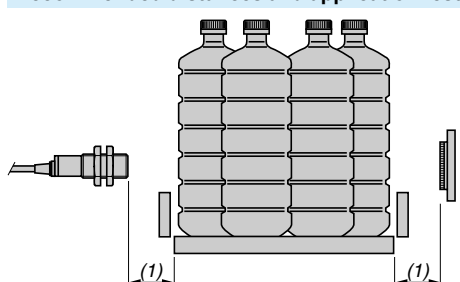

(1) Blind zone

## Application examples

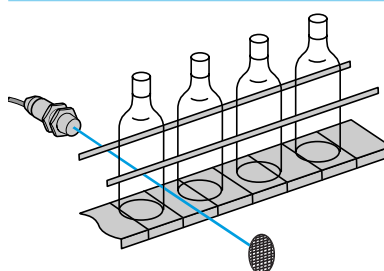

Detection of transparent bottles

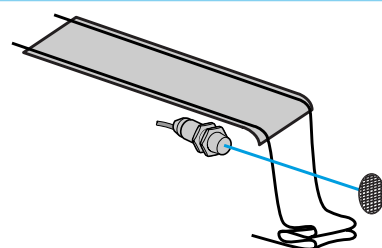

Detection of plastic film

For precise detection or magnifying glass effect cases, it is advisable to use XUBT●●●●M12/L2.

# Photo-electric sensors

OsiSense XU, Application, packaging series  
For detection of transparent materials  
DC supply. Solid-state output

## Compact design

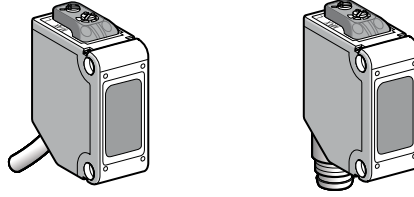

<b>System</b>	<b>Reflex</b>
<b>Type of transmission</b>	Infra-red
<b>Nominal sensing distance (Sn)</b>	<b>0.1...1 m with reflector XUZC50CR (1)</b> <b>0.8...2 m with reflector XUZC50 (1)</b>
<b>Adjustment</b>	270° potentiometer

## References

<b>3-wire</b>	NO or NC programmable function	PNP <b>XUMTAPCNL2</b>	NPN <b>XUMTANCNL2</b>	PNP <b>XUMTAPCNM8</b>	NPN <b>XUMTANCNM8</b>	PNP <b>XUMTAPCNL03M12</b>
<b>Weight (kg)</b>		0.155	0.155	0.055	0.055	0.055

## Characteristics

<b>Product certifications</b>		CE, cURus		
<b>Ambient air temperature</b>		For operation: -25...+55°C. For storage: -30...+70°C		
<b>Vibration resistance</b>	Conforming to IEC 60068-2-8	20 gn max., amplitude: 3 mm, frequency: 10...500 Hz		
<b>Shock resistance</b>	Conforming to IEC 60068-2-27	50 gn		
<b>Degree of protection</b>	Conforming to IEC 60529	IP 67		
<b>Material</b>		Case: PBT Lenses: polycarbonate		
<b>Indicator lights</b>	Output state Power on, help with setting	Orange LED Green LED		
<b>Connection</b>		2 m cable Conductor c.s.a.: 0.2 mm <sup>2</sup>	M8 4-pin connector	Remote M12 connector 0.3 m cable Conductor c.s.a.: 0.2 mm <sup>2</sup>
<b>Rated supply voltage</b>		<b>12...24 V</b> with protection against reverse polarity		
<b>Voltage limits</b>		10...30 V (including ripple)		
<b>Switching capacity</b>		≤ 100 mA with overload and short-circuit protection		
<b>Immunity to ambient light</b>	Natural light	3000 lux		
	Incandescent bulb	3000 lux		
<b>Voltage drop, closed state</b>		< 2 V		
<b>Current consumption</b>		≤ 10 mA		
<b>Response time</b>		≤ 1 ms		

Function table	Function	Diffuse system			
		No object present in the beam		Object present in the beam	
State of output (PNP or NPN) and orange LED (illuminated when sensor output is ON)	NO (position D)				
	NC (position L)				

## Accessories

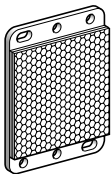

XUZC50  
XUZC50CR

Description	Dimensions	Reference	Weight kg
<b>Standard reflector</b> Reflector distance from the product: 0.8 to 2 m	50 x 50 mm	<b>XUZC50</b>	0.020
<b>Application reflector</b> Reflector distance from the product: 0.2 to 1 m	50 x 50 mm	<b>XUZC50CR</b>	0.020

(1) Reflector to be ordered separately.



### Dimensions

**XUMTAPCNL2, XUMTANCNL2 and XUMTAPCNL03M12**

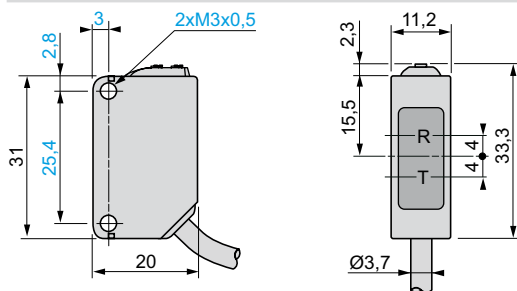

**XUMTAPCNM8 and XUMTANCNM8**

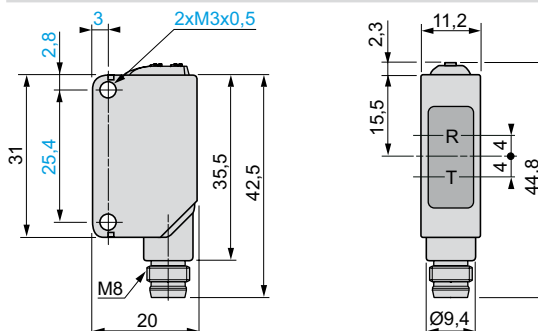

R: Reception, T: Transmission

### Mounting

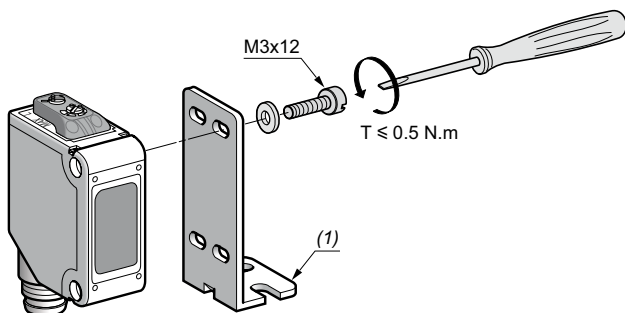

(1) XUZA50, XUZAM02 or XUZAM03 metal bracket (see page 34).

### Functions

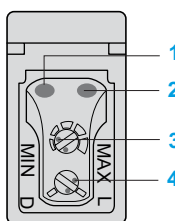

- 1 Stability indicator (green). LED on in stable detection conditions (NO or NC).
- 2 Change indicator (orange). LED lit when the detection output has been activated.
- 3 Sensitivity adjustment potentiometer.
- 4 NO/NC operating mode selector switch.

NO/NC selector switch	Function	Details
	NC (position L)	NC mode is obtained when the selector switch slot is fully turned to position L.
	NO (position D)	NO mode is obtained when the selector switch slot is fully turned to position D.

### Connections

Wiring schemes (3-wire ---)

PNP output

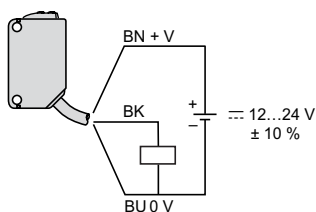

NPN output

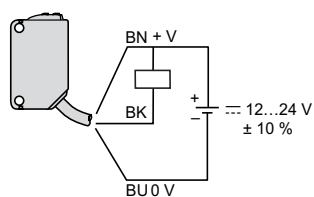

Cable connections

XUMTA●CNL2

- (-) BU (Blue)
- (+) BN (Brown)
- (OUT) BK (Black)

Connector schemes

XUMTA●CNM8

- M8 connector
- 2 4 3 (-)
  - 1 (+)
  - 3 4 Output
  - 2 Not connected

XUMTAPCNL03M12

- M12 connector
- 4 3 3 (-)
  - 1 (+)
  - 4 Output
  - 1 2 2 Not connected

Please refer to our "Cabling accessories OsiSense XZ" catalogue.

# Photo-electric sensors

OsiSense XU Application, packaging series  
For detection of transparent materials, with teach mode  
and automatic compensation for accumulation of dirt <sup>(1)</sup>  
Solid-state output

## Compact design

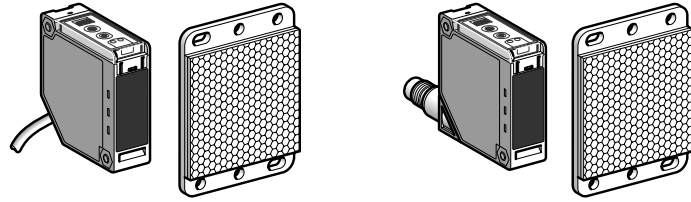

<b>System</b>	<b>Reflex</b>
<b>Type of transmission</b>	Red
<b>Nominal sensing distance (Sn)</b>	1.5 m (with 50 x 50 mm reflector)

## References

3-wire, PNP or NPN	NO or NC programmable function	<b>XUKT1KSML2</b> (2)	<b>XUKT1KSMM12</b> (2)
Weight (kg)		0.280	0.120

## Characteristics

<b>Product certifications</b>	CE, UL, CSA	
<b>Ambient air temperature</b>	For operation	- 25...+ 55 °C
	For storage	- 30...+ 70 °C
<b>Vibration resistance</b>	Conforming to IEC 60068-2-6	7 gn (f = 10...55 Hz)
<b>Shock resistance</b>	Conforming to IEC 60068-2-27	10 gn, duration 11 ms
<b>Degree of protection</b>	Conforming to IEC 60529	IP 65
<b>Materials</b>	Case	PC
	Lenses	PMMA
	Cable	PVC
<b>Connection</b>	Pre-cabled, diameter 6 mm, length 2 m, wire c.s.a.: 4 x 0.34 mm <sup>2</sup>	M12 male connector, can be set at 2 positions (suitable female connectors, including pre-wired versions)
<b>Rated supply voltage</b>	--- 12...24 V with protection against reverse polarity	
<b>Voltage limits</b>	--- 10...30 V (including ripple)	
<b>Switching capacity (sealed)</b>	≤ 100 mA with overload and short-circuit protection	
<b>Voltage drop, closed state</b>	≤ 2 V	
<b>Current consumption, no-load</b>	≤ 35 mA	
<b>Maximum switching frequency</b>	1500 Hz	
<b>Delays</b>	First-up	≤ 80 ms
	Response	≤ 0.3 ms
	Recovery	≤ 0.3 ms
<b>Time delay</b>	Monostable, on-delay or off-delay (programmable) adjustable from 0.1 to 5 seconds	

Function table	Function	Reflex system	
		No object present in the beam	Object present in the beam
Output state (PNP or NPN) indicator: yellow LED (illuminated when sensor output is ON)	NC		
	NO		

(1) Sensor memorises, in teach mode, the environmental conditions in which the object is to be detected and adapts to any variations.  
(2) 50 x 50 mm reflector **XUZC50** included with the sensor.

# Photo-electric sensors

OsiSense XU Application, packaging series  
For detection of transparent materials, with teach mode  
and automatic compensation for accumulation of dirt  
Solid-state output

## Dimensions

XUKT1KSML2 (1)

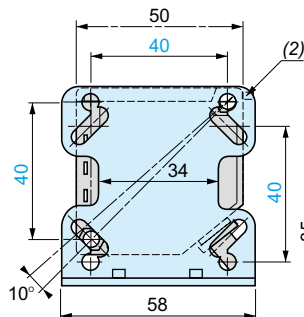

Bracket fixing (1)

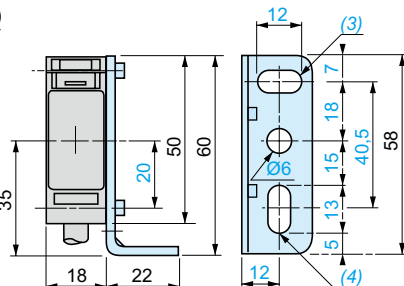

XUKT1KSMM12 with cover open

Fixing bracket mounting according to position of connector (1)

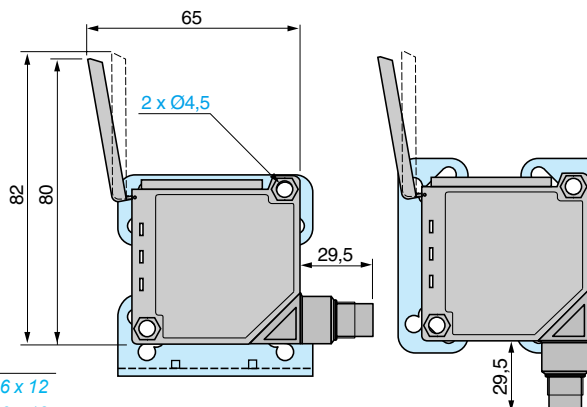

(1) The bracket **XUZA51** is included with the sensor.

(2) Cover locking tongue

(3) 1 elongated hole  $\text{Ø} 6 \times 12$

(4) 1 elongated hole  $\text{Ø} 6 \times 13$

## Wiring schemes (3-wire ---)

### NC programmed

PNP programmed output

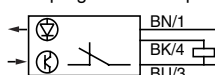

NPN programmed output

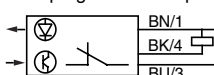

### NO programmed

PNP programmed output

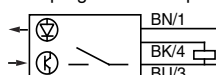

NPN programmed output

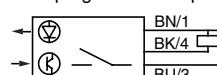

### Alarm output

PNP programmed

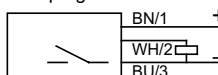

NPN programmed



## Connection

### Cable connections

#### XUKT1KSML2

- (-) BU (Blue)
- (+) BN (Brown)
- (OUT) BK (Black)
- Alarm WH (White)

### Connector scheme

#### XUKT1KSMM12

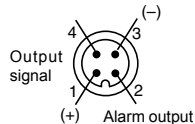

## Functions

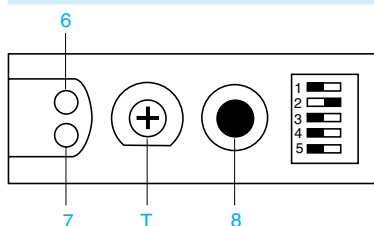

### Switches

- 1 NC/NO programming
- 2 Time delay activated or deactivated
- 3 Normal time delay or monostable
- 4 Normal time delay "On-delay" or "Off-delay"
- 5 PNP or NPN output

### LED

- 6 Yellow LED: output and teach mode aid
- 7 Red LED: alignment aid and alarm indicator

### Potentiometer and button

- T Time delay adjustment
- 8 Teach mode button

## Time delays

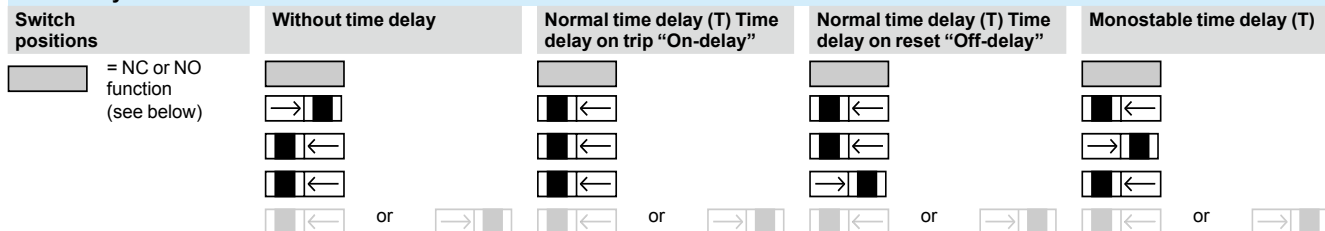

### Receiver state

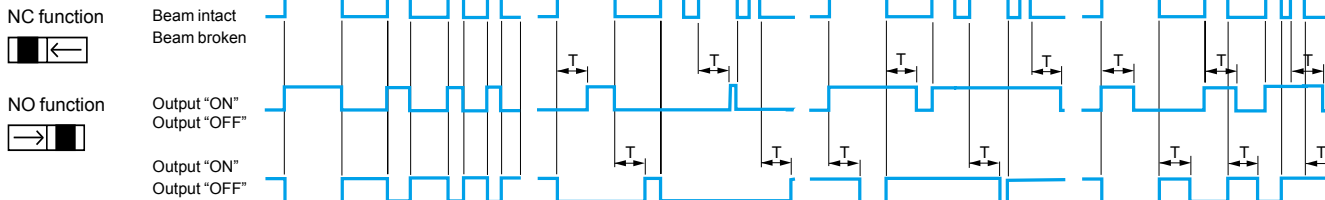

# Photo-electric sensors

OsiSense XU Application, packaging series  
Compact design, 50 x 50  
For colour detection <sup>(1)</sup>  
DC supply. Solid-state output

**Compact design, 50 x 50**

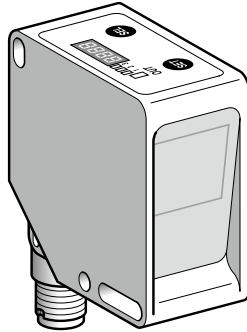

System	Diffuse
Type of transmission	White LED (400-700 nm)
Type of colour processing	RGB
Nominal sensing distance (Sn)	20 mm (Operational distance, see curve on page 91)

**References**

3-wire, PNP + 1 synchro input	NO function	XUKC1PSMM12
3-wire, NPN + 1 synchro input	NO function	XUKC1NSMM12
Weight (kg)		0.085

**Characteristics**

Product certifications		CE, cULus
Ambient air temperature	For operation	- 10...+ 55 °C
	For storage	- 20...+ 70 °C
Vibration resistance	Conforming to IEC 60068-2-6	7 gn, amplitude ± 0.5 mm (f = 10...55 Hz for each axis)
Shock resistance	Conforming to IEC 60068-2-27	30 gn, duration 11 ms, 6 shocks on each axis
Degree of protection	Conforming to IEC 60529	IP 65
Connection		M12, 8-pin connector; can be set at 90°
Materials	Case	ABS
	Lenses	Glass (window tilted, anti-reflective glass)
Spot diameter		At 20 mm: Ø 4 mm
Adjustment	Teach mode	Teaching using SET (adjustment) and SEL (Selection) buttons
	Operating mode	C (colour) or C+I (colour + intensity), independent for each channel
	Tolerance level	Selectable tolerance for varying shades of colour from TOL 0 to TOL 9
Auxiliary functions		External synchronisation, locking
Indicator lights and display	Display	4-digit
	Output active	3 green LEDs: output 1, 2 or 3
	Output state "OUT"	Yellow LED if one output (1, 2 or 3) activated
Rated supply voltage		12...24 V
Voltage limits		10...30 V (including ripple)
Switching capacity (sealed)		≤ 100 mA with protection against reverse polarity, overload and short-circuit
Voltage drop, closed state		≤ 2 V
Current consumption, no-load		≤ 60 mA
Maximum switching frequency		1.5 kHz
Delay		335 µs for response and recovery
Time delay		Selectable (5, 10, 20, 30 or 40 ms)

Function table for each channel (3 channels) NO function	Colour recognised by sensor	Colour not recognised by sensor
Output state (PNP or NPN) indicator (illuminated when sensor output is ON)		

(1) Applications: OsiSense XU "Full colour" is a colour sensor that can recognise up to 3 colours. It can be used to sort objects by colour or to monitor colours, and is insensitive to surface finishes (matt or reflective), as well as ambient lighting. The sensor is suitable for use in many industrial sectors, such as packaging machines, printing machines, etc.



# Photo-electric sensors

OsiSense XU Application, multimode

food and beverage processing series

Design 18, metal, stainless steel

Three-wire DC, solid-state output

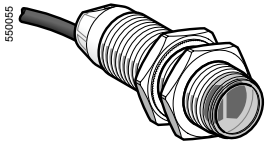

XUB0...NL2

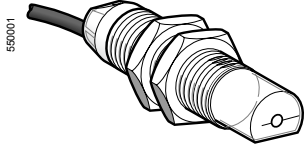

XUB0...WL2

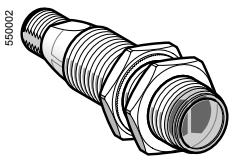

XUB0...NM12

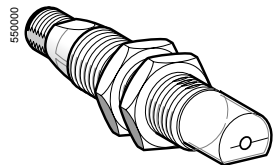

XUB0...WM12

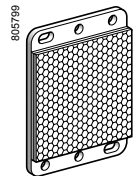

XUZC50



XUZA118

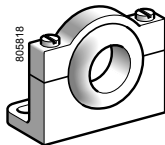

XUZA218

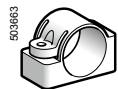

XUZB2005

## Ø 18 stainless steel

### Pre-cabled (1)

Sensing distance (Sn) (2) m	Function	Output	Line of sight	Reference	Weight kg
0...20 depending on whether accessories are used	NO or NC, by programming	PNP	Along case axis	<b>XUB0SPSNL2</b>	0.105
			90° to case axis	<b>XUB0SPSWL2 (3)</b>	0.110
		NPN	Along case axis	<b>XUB0SNSNL2</b>	0.105
			90° to case axis	<b>XUB0SNSWL2 (3)</b>	0.110

### M12 connector

0...20 depending on whether accessories are used	NO or NC, by programming	PNP	Along case axis	<b>XUB0SPSNM12</b>	0.055
			90° to case axis	<b>XUB0SPSWM12 (3)</b>	0.060
		NPN	Along case axis	<b>XUB0SNSNM12</b>	0.055
			90° to case axis	<b>XUB0SNSWM12 (3)</b>	0.060

### Accessories

Description	Connecti-on	Line of sight	Reference	Weight kg
<b>Thru-beam accessories (transmitter)</b>	Pre-cabled (1)	Along case axis	<b>XUB0SKSNL2T</b>	0.105
		90° to case axis	<b>XUB0SKSWL2T (3)</b>	0.110
	M12 connector	Along case axis	<b>XUB0SKSNM12T</b>	0.055
		90° to case axis	<b>XUB0SKSWM12T (3)</b>	0.060
<b>Reflector 50 x 50 mm</b>	–	–	<b>XUZC50</b>	0.020

### Fixing accessories (4)

Description	Reference	Weight kg
<b>Stainless steel fixing bracket</b>	<b>XUZA118</b>	0.045
<b>Plastic fixing bracket with adjustable ball-joint</b>	<b>XUZA218</b>	0.035
<b>Plastic fixing clamp, 24.1 mm centres with locking screw</b>	<b>XUZB2005</b>	0.007

(1) For a 5 m long cable, replace L2 by L5.

Example: XUB0SPSNL2 becomes XUB0SPSNL5.

(2) For further information, see page 32.

(3) For line of sight 90° to case axis versions, see sensing distances on page 32.

(4) For further information, see page 164.

**Characteristics**

		XUB0●●●●M12, XUB0●●●●M12T	XUB0●●●●L2, XUB0●●●●L2T
<b>Sensor type</b>		UL, CSA, CE	
<b>Product certifications</b>		UL, CSA, CE	
<b>Connection</b>	Connector	M12	—
	Pre-cabled	—	Length: 2 m
<b>Sensing distance</b> nominal $S_n$ / maximum (excess gain = 2) (excess gain = 1)	<b>Line of sight along case axis</b>	<b>Line of sight 90° to case axis</b>	<b>Accessory</b>
		m 0.12 / 0.12	Without (diffuse with background suppression)
	<b>Line of sight 90° to case axis</b>	m 0.3 / 0.4	Without (diffuse)
		m 3 / 4.5	With reflector (polarised reflex)
	m 20 / 30	10 / 14	With thru-beam accessory (thru-beam)
<b>Type of transmission</b>		Infrared, except polarised reflex (red)	
<b>Degree of protection</b>		IP 65, IP 67 conforming to IEC 60529; IP 69K conforming to DIN 40050; double insulation II	
<b>Storage temperature</b>		°C - 40...+ 70	
<b>Operating temperature</b>		°C - 25...+ 55	
<b>Materials</b>		Case: stainless steel, grade 304CU; Lens: PMMA; Cable: PvR	
<b>Vibration resistance</b>	Conforming to IEC 60068-2-6	7 gn, amplitude ± 1.5 mm (f = 10 to 55 Hz)	
<b>Shock resistance</b>	Conforming to IEC 60068-2-27	30 gn, duration 11 ms	
<b>Indicator lights</b>	Output state	Yellow LED (transmission present for XUB0●●●●●●T)	
	Supply on	Green LED	
	Optical alignment aid / dirty	Red LED (except for XUB0●●●●●●T)	
<b>Rated supply voltage</b>		V --- 12...24 with protection against reverse polarity	
<b>Voltage limits (including ripple)</b>		V --- 10...36	
<b>Current consumption, no-load</b>		mA 35 (20 for XUB0●●●●●●T)	
<b>Switching capacity</b>		mA ≤ 100 with overload and short-circuit protection	
<b>Voltage drop, closed state</b>		V 1.5	
<b>Maximum switching frequency</b>		Hz 250 (200 for diffuse with background suppression)	
<b>Delays</b>	First-up	ms < 200	
	Response	ms < 2 (< 2.5 for diffuse with background suppression)	
	Recovery	ms < 2 (< 2.5 for diffuse with background suppression)	

**Wiring schemes**

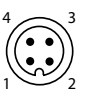
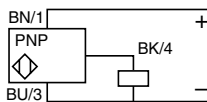
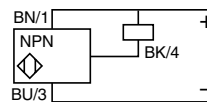
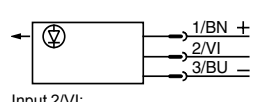
M12 connector	Pre-cabled	PNP	NPN	Thru-beam accessory
 <p>3 (-) 1 (+) 4 OUT/Output 2 Beam break input (1)</p>	<p>(-) BU (Blue) (+) BN (Brown) OUT/Output BK (Black) Beam break input (1) VI (Violet)</p>	 <p>BN/1 PNP BK/4 BU/3</p>	 <p>BN/1 NPN BK/4 BU/3</p>	 <p>1/BN + 2/VI 3/BU -</p> <p>Input 2/VI: - not connected: beam made - connected to -: beam broken</p>

**Detection curves (line of sight along case axis)**

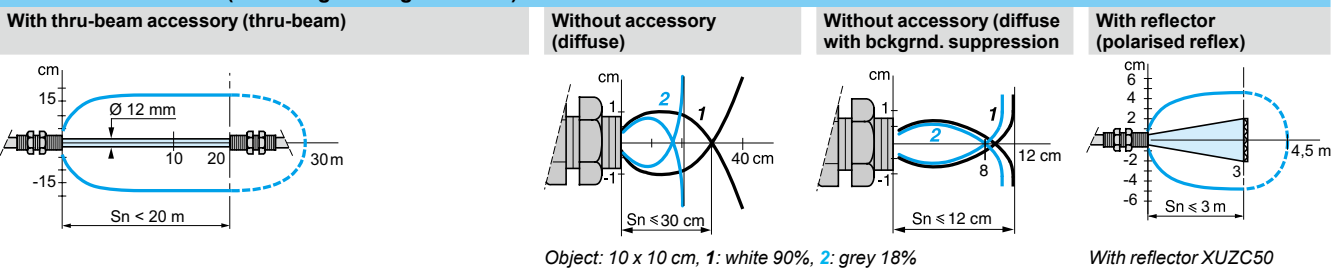

**Variation of usable sensing distance  $S_u$  (without accessory, with adjustable background suppression)**

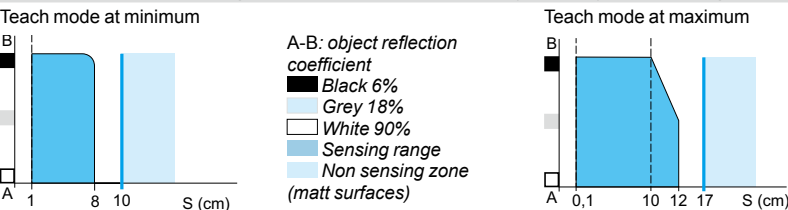

**Dimensions**

XUB	Pre-cabled (mm)		Connector (mm)	
	a	b	a	b
Ø 18, line of sight along case axis	64 (2)	44	78 (2)	44
Ø 18, line of sight 90° to case axis	78	44	92	44

(1) Beam break input on thru-beam transmitter only.  
(2) For XUB0●●●●●●T, 64 becomes 62 mm and 78 becomes 76 mm.

# Photo-electric sensors

OsiSense XU Application, single mode  
food and beverage processing series  
Stainless steel case M18 x 1  
DC. Solid-state output

**Design 18**

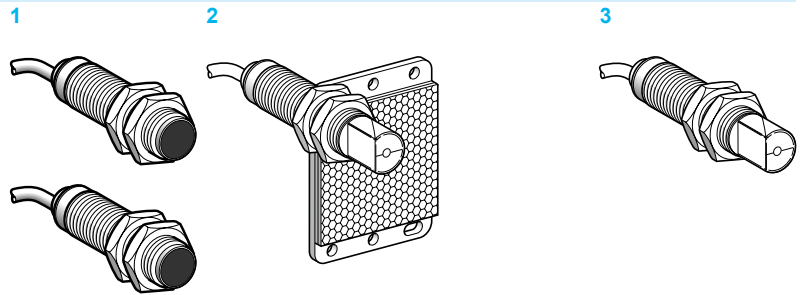

System		Thru-beam 1	Reflex 2	Polarised reflex 2	Diffuse 3
Type of transmission		Infrared	Infrared	Red	Infrared
Sensing distance	Nominal Sn (excess gain = 2)	15 m	4 m	2 m	0.10 m
	Maximum (excess gain = 1)	20 m	5.5 m (with 50 x 50 mm reflector)	3 m (with 50 x 50 mm reflector)	0.15 m

**References of pre-cabled versions (1)**

3-wire, PNP NO or NC programmable function	Line of sight along case axis	XU2N18PP341 (2)	XU1N18PP341 (3)	XU9N18PP341 (3)	XU5N18PP341
	Line of sight 90° to case axis	XU2N18PP341W (2)	XU1N18PP341W (3)	XU9N18PP341W (3)	XU5N18PP341W
3-wire, NPN NO or NC programmable function	Line of sight along case axis	XU2N18NP341 (2)	XU1N18NP341 (3)	XU9N18NP341 (3)	XU5N18NP341
	Line of sight 90° to case axis	XU2N18NP341W (2)	XU1N18NP341W (3)	XU9N18NP341W (3)	XU5N18NP341W
Weight (kg)		0.270	0.155	0.155	0.135

**References of connector versions**

3-wire, PNP NO or NC programmable function	Line of sight along case axis	XU2N18PP341D (2)	XU1N18PP341D (3)	XU9N18PP341D (3)	XU5N18PP341D
	Line of sight 90° to case axis	XU2N18PP341WD (2)	XU1N18PP341WD (3)	XU9N18PP341WD (3)	XU5N18PP341WD
3-wire, NPN NO or NC programmable function	Line of sight along case axis	XU2N18NP341D (2)	XU1N18NP341D (3)	XU9N18NP341D (3)	XU5N18NP341D
	Line of sight 90° to case axis	XU2N18NP341WD (2)	XU1N18NP341WD (3)	XU9N18NP341WD (3)	XU5N18NP341WD
Weight (kg)		0.130	0.085	0.085	0.065

**Fixing accessories (4)**

Description	Reference	Weight kg
Stainless steel fixing bracket	XUZA118	0.045
Plastic fixing bracket	XUZA218	0.035
Set of 2 stainless steel nuts	XSZE318	0.020
Set of 2 plastic nuts	XSZE218	0.004

(1) Sensors available with 5 m long cable: To order, add L5 to the end of the reference selected from above.

Example: sensor XU1N18PP341 with 5 m cable becomes XU1N18PP341L5.

(2) Reference for both transmitter and receiver for thru-beam system sensors.

(3) 50 x 50 mm reflector included with reflex system sensors.

(4) For further information, see page 164.



**Characteristics**

<b>Product certifications</b>		CE, UL, CSA
<b>Ambient air temperature</b>		For operation: -25...0...+55 °C. For storage: -40...+70 °C
<b>Vibration resistance</b>	Conforming to IEC 60068-2-6	25 gn, amplitude ± 1.5 mm (f = 10...55 Hz)
<b>Shock resistance</b>	Conforming to IEC 60068-2-27	30 gn, duration 11 ms
<b>Degree of protection</b>		IP 67
<b>Connection</b>	Pre-cabled	Pre-cabled, diameter 4.2 mm, length 2 m (3), wire c.s.a.: 4 x 0.34 mm <sup>2</sup>
	Connector	M12 male connector, 4-pin (suitable female connectors, including pre-wired versions)
<b>Materials</b>		
	Case	Food and beverage processing stainless steel, grade 304 Cu
	Lenses	PMMA
	Cable	PvR
<b>Rated supply voltage</b>		12...24 with protection against reverse polarity
<b>Voltage limits</b>		10...30 V (including ripple)
<b>Switching capacity (sealed)</b>		≤100 mA with overload and short-circuit protection
<b>Voltage drop, closed state</b>		≤ 1.5 V
<b>Current consumption, no-load</b>		≤ 30 mA (reflex and diffuse), ≤ 50 mA (thru-beam)
<b>Maximum switching frequency</b>		500 Hz
<b>Delays</b>		
	First-up	≤ 15 ms
	Response	≤ 1 ms
	Recovery	≤ 1 ms
<b>Indicator lights</b>		
	Supply on	Green LED, on transmitter only
	Output state	Yellow LED, on receiver only

(1) Sensors available with 5 m long cable: To order, add L5 to the end of the reference selected from above.  
Example: sensor XU1N18PP341 with 5 m cable becomes XU1N18PP341L5.

**Curves**

**Detection curves**

**Thru-beam system**

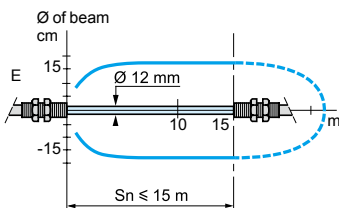

**Reflex system with reflector XUZC50**

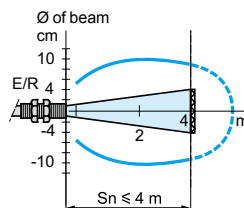

**Polarised reflex system with reflector XUZC50**

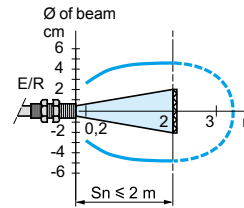

**Diffuse system**

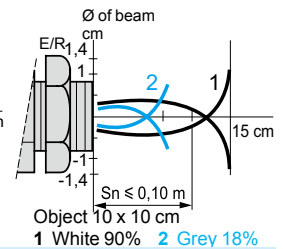

**Excess gain curves (ambient temperature: + 25 °C)**

**Thru-beam system**

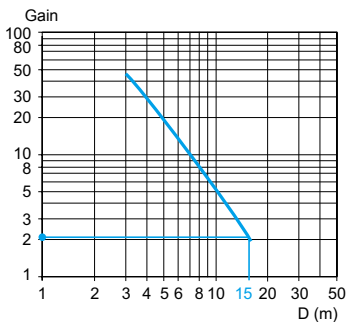

**Reflex system with reflector XUZC50**

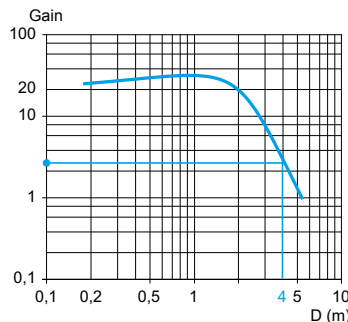

**Polarised reflex system with reflector XUZC50**

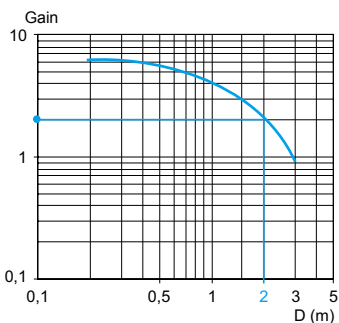

**Diffuse system**

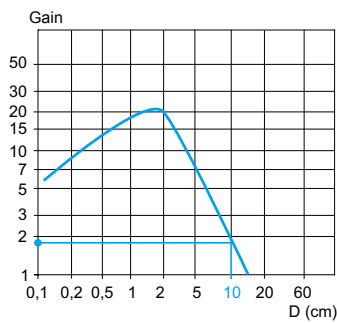

Object 10 x 10 cm  
White 90%

# Photo-electric sensors

OsiSense XU Application, single mode  
 food and beverage processing series  
 Stainless steel case M18 x 1  
 DC. Solid-state output

## Dimensions

XU●N18●●341

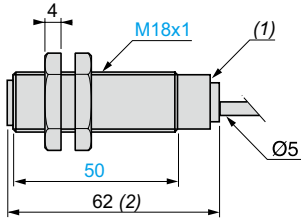

XU●N18●●341W

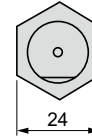
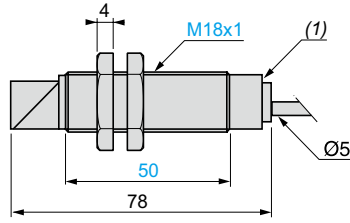

XU●N18●●341D

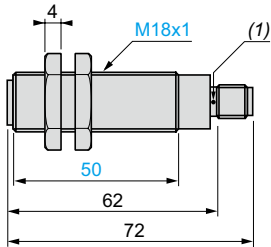

XU●N18●●341WD

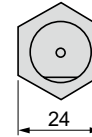
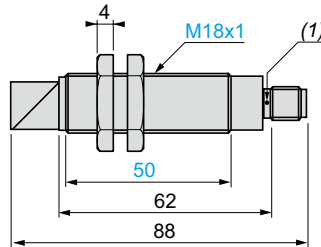

(1) LED

(2) 64 for XU9N18●●341

Fixing nut tightening torque: < 15 N.m

Connector tightening torque: 2 N.m

# Photo-electric sensors

OsiSense XU Application, single mode  
 food and beverage processing series  
 Stainless steel case M18 x 1  
 DC. Solid-state output

## Wiring schemes

### M12 connector



3 (-)  
 1 (+)  
 4 OUT/Output  
 2 Prog (or beam break input for thru-beam transmitter only)

### Pre-cabled

(-) BU (Blue)  
 (+) BN (Brown)  
 (Out/Output) BK (Black)  
 (Prog) OG (Orange)  
 (Beam break input) VI (Violet) on thru-beam transmitter only

## Wiring schemes - diffuse

### PNP NO

### PNP NC

### NPN NO

### NPN NC

### Transmitter

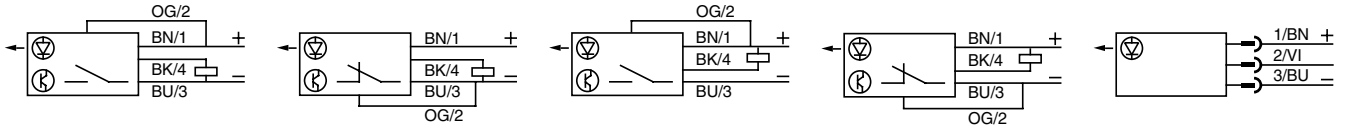

## Wiring schemes - reflex and thru-beam

### PNP NO

### PNP NC

### NPN NO

### NPN NC

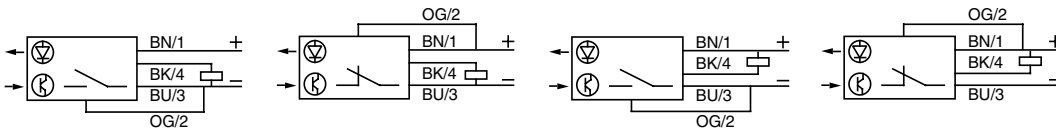

## Beam break input on thru-beam transmitter only

### Beam made

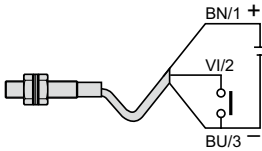

### Beam broken

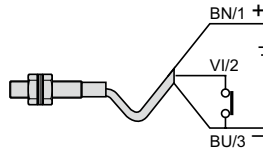

# Photo-electric sensors

OsiSense XU Application, single mode  
food and beverage processing series  
Stainless steel 316 case, M12 connector  
DC

Compact design

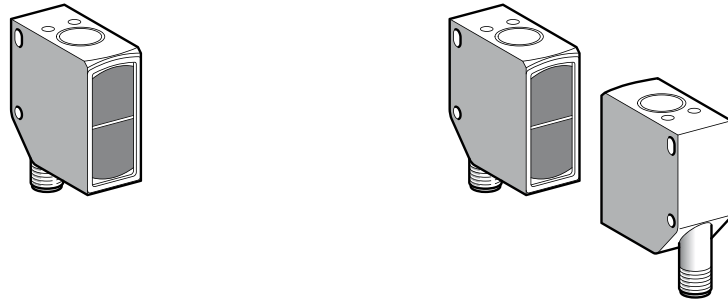

System	Diffuse with background suppression	Polarised reflex	Thru-beam
Type of transmission conforming to EN 62471 (2008)	Red beam		
Nominal sensing distance (Sn)/Maximum sensing distance	3...550 mm, on white 90% 12...550 mm, on grey 18% 20...550 mm, on black 6% (1), (2)	0.4...11/13 m (with reflector XUZC100) 0.4...9 m (with reflector XUZC80) 0.4...6 m (with reflector XUZC50)	0...15/20 m

References

4-wire, PNP	XUK8SPSMM12	XUK9SPSMM12	Transmitter: XUK2SKSMM12T	Receiver: XUK2SPSMM12R
Weight (kg)	0.150	0.150	0.150	0.150

Characteristics

Product certifications	CE			
Connection	M12, 4-pin connector			
Degree of protection	Conforming to IEC 60529	IP 67		
	Conforming to DIN 40050	IP 69K		
Ambient air temperature	For operation	-20...+60 °C (100 °C for cleaning and sterilization phases whilst not in service)		
	For storage	-20...+80 °C		
Materials	Case	Stainless steel 316L		
	Lenses	PMMA		
Vibration resistance	Conforming to EN/IEC 60947-5-2 and EN/IEC 60947-4-2	Amplitude ±0.5 mm (f = 10 to 55 Hz)		
Shock resistance	Conforming to EN/IEC 60947-5-2 and EN/IEC 60947-4-1	30 gn, duration 11 ms		
Indicator lights	Output state	Yellow LED	Yellow LED	–
	Supply on	Green LED		Yellow LED
	Unstable	Yellow LED, flashing		Red LED
Rated supply voltage	10...30 V ~			
Voltage limits (including ripple)	±10% of rated operational voltage			
Current consumption, no-load	< 30 mA			
Switching capacity	≤ 100 mA, with protection against reverse polarity, overload and short-circuit			
Test function	Breaking red beam	–	–	Yes
Voltage drop, closed state	≤ 2.4 V			
Maximum switching frequency	400 Hz	600 Hz	–	500 Hz
Delays	First-up	< 300 ms		
	Response	1.2 ms	0.8 ms	–
	Recovery	1.2 ms	0.8 ms	–

(1) Sensing distance adjustable between 100 and 550 mm.  
(2) % of object remission.

# Photo-electric sensors

OsiSense XU Application, single mode  
food and beverage processing series  
Stainless steel 316 case, M12 connector  
DC

## References of accessories



XUZC80

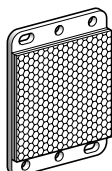

XUZC50/XUZC50CR

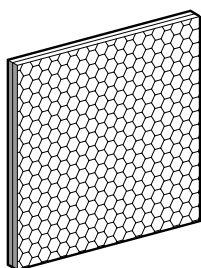

XUZC100

Description	Dimensions	Reference	Weight kg
<b>Fixing bracket</b> stainless steel 316	–	<b>XUZA51S</b>	0.050
<b>Reflector</b>	100 x 100 mm	<b>XUZC100</b>	0.062
<b>Standard reflector</b>	Ø 80 mm	<b>XUZC80</b>	0.029
<b>Universal reflector</b>	50 x 50 mm	<b>XUZC50</b>	0.020
<b>Reflector (1)</b> resistant to ECOLAB® detergents, up to 140 °C	50 x 50 mm	<b>XUZC50CR</b>	0.020
<b>Pre-wired connector, straight</b> PVC cable M12, 4-pin, female connector, stainless steel clamping ring	5 m	<b>XZCPA1141L5</b>	0.210
<b>Pre-wired connector, elbowed</b> PVC cable M12, 4-pin, female connector, stainless steel clamping ring	5 m	<b>XZCPA1241L5</b>	0.210

(1) Sensing distances are reduced by 50% compared to reflector XUZC50.

## Optical curves, excess gain curves

### XUK8SPSMM12

#### Scanning properties

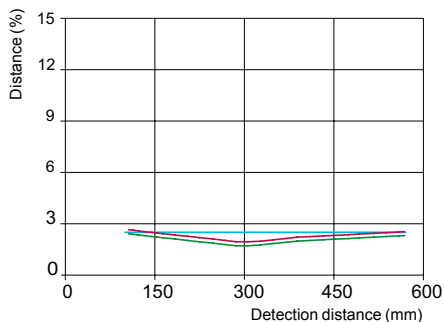

— Black/white 6%/90%  
— Grey/white 18%/90%  
— White/white 90%/90%

#### Size of luminous point

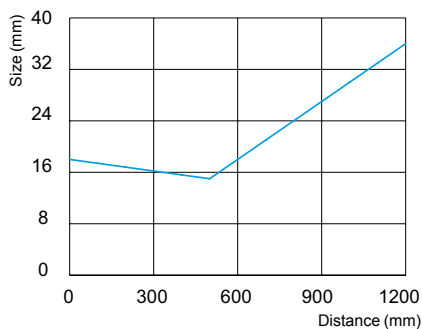

### XUK9SPSMM12

#### Excess gain curve

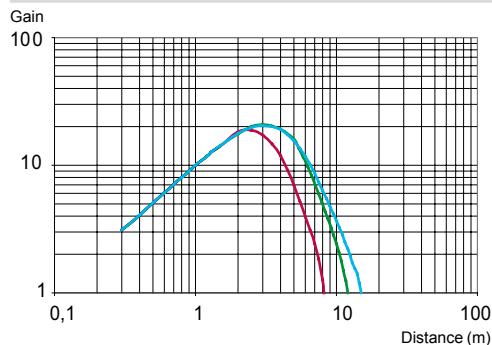

— XUZC50  
— XUZC80  
— XUZC100

#### Size of luminous point

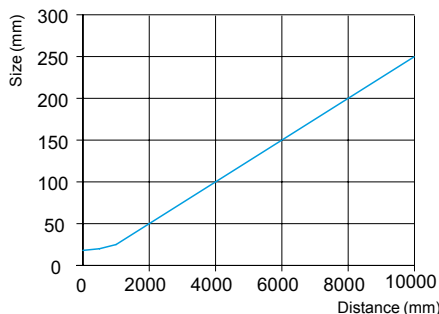

# Photo-electric sensors

OsiSense XU Application, single mode  
food and beverage processing series  
Stainless steel 316 case, M12 connector  
DC

## Optical curves, excess gain curves (continued)

### XUK2SKSMM12T and XUK2SPSMM12R

#### Excess gain curve

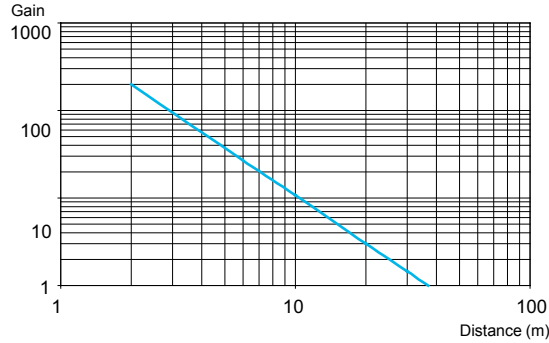

#### Size of luminous point

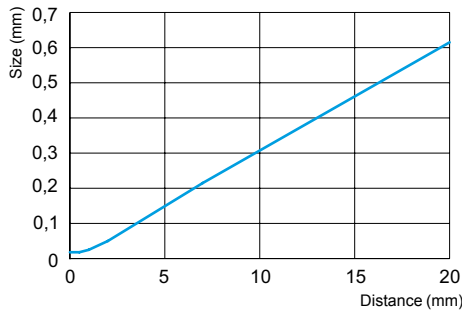

## Wiring schemes

### M12 connector



**XUK8SPSMM12,  
XUK9SPSMM12,  
XUK2SPSMM12R:**

- 1 BN: Brown (+)
- 2 WH: White (ET/Lock) (1)
- 3 BU: Blue (-)
- 4 BK: Black (Output)

**XUK2SKSMM12T:**

- 1 BN: Brown (+)
- 2 WH: White (Test input)
- 3 BU: Blue (-)
- 4 BK: Black (pin not connected)

### PNP receiver

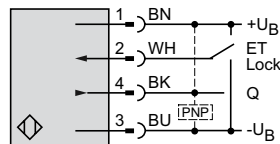

### Thru-beam transmitter ...

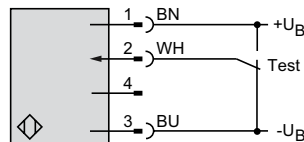

(1) ET/Lock. ET: External Teach, Lock: pushbutton locking.

## Photo-electric sensors

OsiSense XU Application, single mode  
 food and beverage processing series  
 Stainless steel 316 case, M12 connector  
 DC

### Dimensions

#### Sensors

XUK8SPSMM12 and XUK9SPSMM12

XUK2SKSMM12T and XUK2SPSMM12R

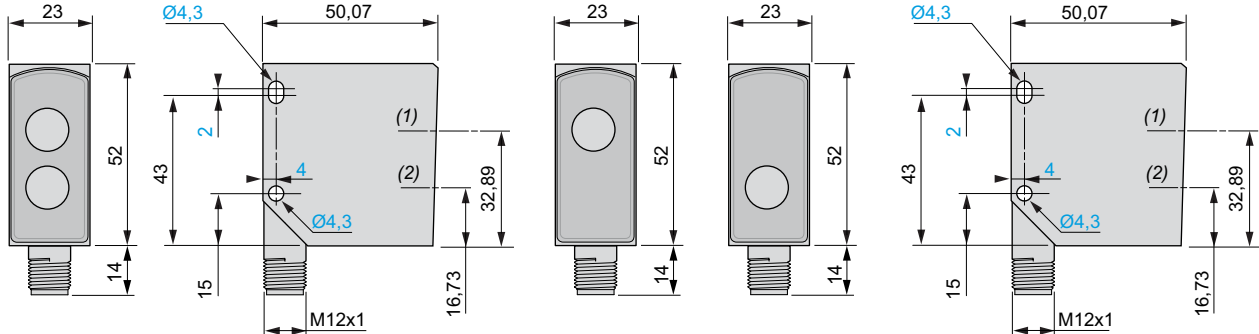

(1) Receiver optical axis.  
 (2) Transmitter optical axis.

#### Reflectors

XUZC80

XUZC100

XUZC50 and XUZC50CR

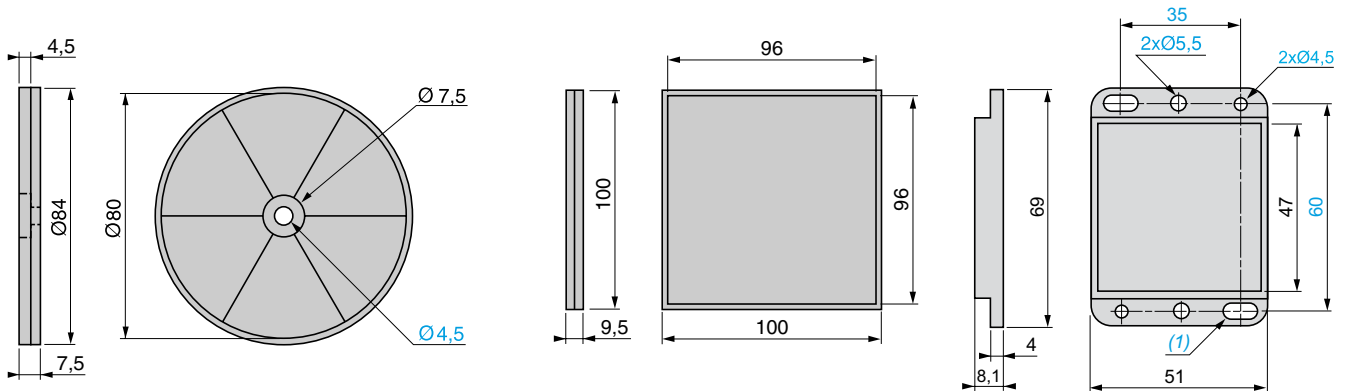

(1) 2 elongated holes for M4 screws.

#### Fixing bracket

XUZA51S

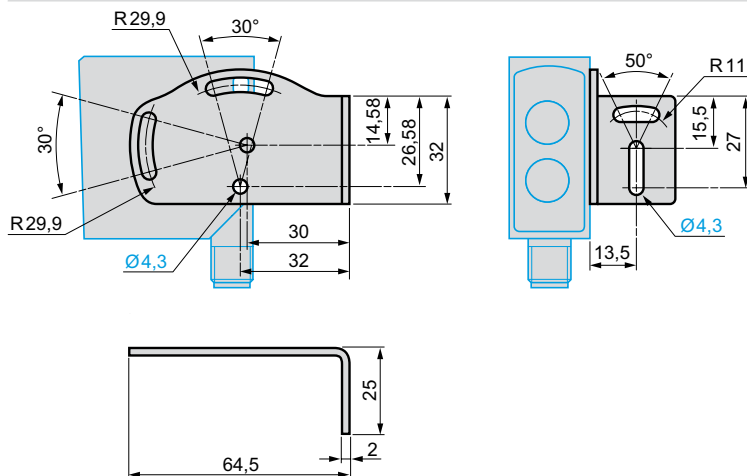

# Photo-electric sensors

OsiSense XU Application, assembly series  
Metal case, cylindrical, threaded M8 x 1  
DC supply. Solid-state output

## Design 8

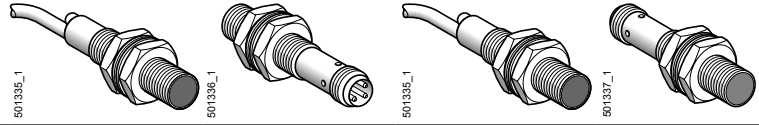

<b>Connection</b>	Pre-cabled Connector	■	–	■	–
<b>System</b>		Thru-beam	Thru-beam	Diffuse	Diffuse
<b>Type of transmission</b>		Infrared	Infrared	Infrared	Infrared
<b>Nominal sensing distance (Sn)</b>		2 m	2 m	0.05 m	0.05 m
<b>References</b>					
<b>3-wire, PNP</b>	NO function	XUAH0214	XUAH0214S	XUAH0515	XUAH0515S
	NC function	XUAH0224	XUAH0224S	XUAH0525	XUAH0525S
<b>3-wire, NPN</b>	NO function	XUAJ0214	XUAJ0214S	XUAJ0515	XUAJ0515S
	NC function	XUAJ0224	XUAJ0224S	XUAJ0525	XUAJ0525S
<b>Transmitter</b>		XUAH0203	XUAH0203S	–	–
<b>Weight (kg)</b>		0.050	0.015	0.50	0.015

## Characteristics

<b>Product certifications</b>		CE, cULus			
<b>Ambient air temperature</b>	For operation	– 25...+ 55 °C			
	For storage	– 30...+ 70 °C			
<b>Vibration resistance</b>	Conforming to IEC 60068-2-6	7 gn, amplitude ± 1 mm (f = 10...55 Hz)			
<b>Shock resistance</b>	Conforming to IEC 60068-2-27	30 gn, duration 11 ms			
<b>Degree of protection</b>	Conforming to IEC 60529	IP 67 - IP 65	IP 65	IP 67 - IP 65	IP 65
<b>Connection</b>	Pre-cabled	Ø 3.5 mm, length 2 m, wire c.s.a.: 3 x 0.14 mm <sup>2</sup>			
	Connector	M8 female connectors, 3-pin			
<b>Materials</b>	Case	Nickel plated brass			
	Cable	PvR	–	PvR	–
	Lenses	PMMA			
<b>Rated supply voltage</b>		⎓ 12...24 V with protection against reverse polarity			
<b>Voltage limits (including ripple)</b>		⎓ 10...30 V			
<b>Switching capacity (sealed)</b>		≤ 100 mA with overload and short-circuit protection			
<b>Voltage drop, closed state</b>		≤ 1 V			
<b>Current consumption, no-load</b>	Transmitter	≤ 15 mA			
	Receiver	≤ 10 mA			
	Diffuse	≤ 25 mA			
<b>Maximum switching frequency</b>		2000 Hz		1000 Hz	
<b>Delays</b>	First-up	≤ 20 ms			
	Response and recovery	≤ 0.25 ms		≤ 0.5 ms	

Function table		Function		Diffuse or through beam system	
				No object present in the beam	Object present in the beam
<b>Output state (PNP or NPN) indicator: yellow LED</b> (illuminated when sensor output is ON)	NO	–	⊗	–	☀
	NC	☀	⊗	–	☀

## Fixing accessories (1)

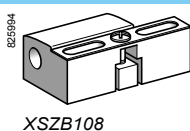

Description	Reference	Weight kg
Plastic fixing clamp with locking screw	XSZA108	0.007
Plastic fixing clamp for sensor replacement without adjustment	XSZB108	0.006

(1) For further information, see page 164.



# Photo-electric sensors

OsiSense XU Application, assembly series  
Metal case, cylindrical, threaded M8 x 1  
DC supply. Solid-state output

## Curves

### Detection curves

#### Thru-beam system

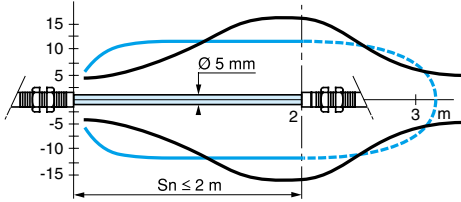

#### Diffuse system

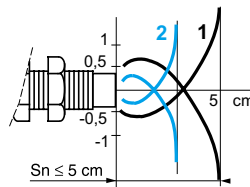

Object 5 x 5 cm; 1 White 90%; 2 Grey 18%

### Excess gain curves (ambient temperature: ± 25 °C)

#### Thru-beam system

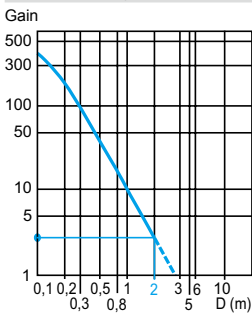

#### Diffuse system

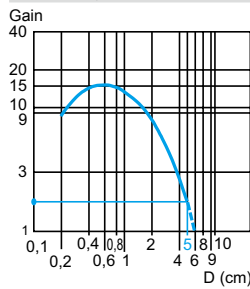

#### Variation of sensing distance Sn

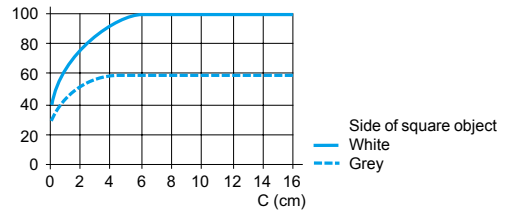

Detection differential (H) when object approaches from the front:  $H \leq 25\%$  of  $S_n$

Object 5 x 5 cm, White 90%

## Dimensions

### XUA

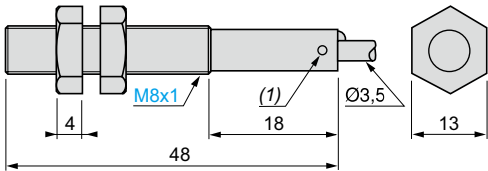

### XUA●●●●●S

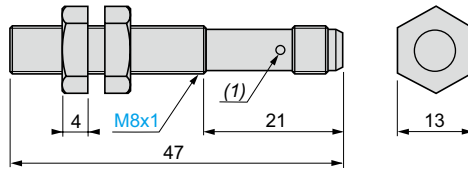

### M8 connector

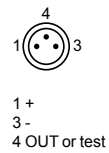

(1) LED, 4 viewing ports at 90°.

(1) LED, 4 viewing ports at 90°. **Note:** fixing nut tightening torque: < 2 N.m

## Wiring schemes (3-wire ---)

### XUA

#### Transmitter

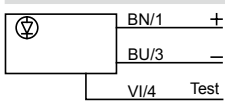

#### PNP

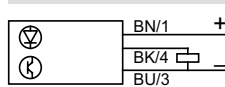

#### NPN

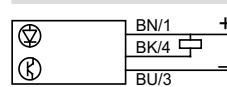

## Beam break test

### For thru-beam transmitter XUAH0203 only

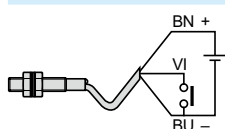

Beam made  
LED on (steady light)

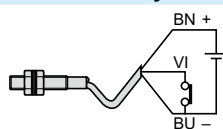

Beam broken  
LED flashing

### For thru-beam transmitter XUAH0203S only

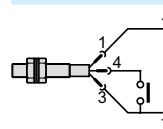

Beam made  
LED on (steady light)

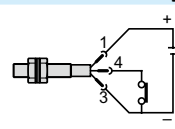

Beam broken  
LED flashing

# Photo-electric sensors

## OsiSense XU Application

### Conveying and access control series

#### Miniature design

#### Four-wire DC, solid-state output

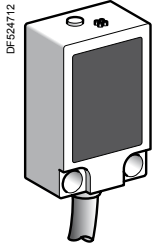

XUYP989S●

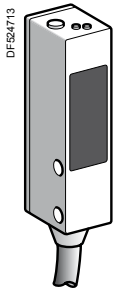

XUYP989S●

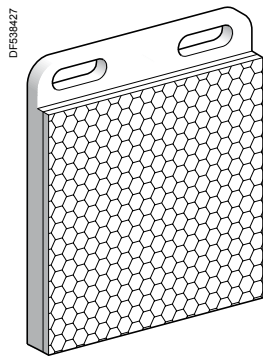

XU1111

#### Diffuse system with background suppression

Sensing dist. (Sn) m	Function	Output	Connection	Reference	Weight kg
0.015...0.08	NO/NC depending on wiring	PNP	Pre-cabled (L = 2 m)	<b>XUYP989SP</b>	0.075
			M8 connector	<b>XUYPCO989SP</b>	0.044
		NPN	Pre-cabled (L = 2 m)	<b>XUYP989SN</b>	0.075
			M8 connector	<b>XUYPCO989SN</b>	0.044

#### Diffuse system with adjustable sensitivity

Sensing dist. (Sn) m	Function	Output	Connection	Reference	Weight kg
0.03...0.25	NO/NC depending on wiring	PNP	Pre-cabled (L = 2 m)	<b>XUYP989SP</b>	0.075
			M8 connector	<b>XUYPCO989SP</b>	0.044
		NPN	Pre-cabled (L = 2 m)	<b>XUYP989SN</b>	0.075
			M8 connector	<b>XUYPCO989SN</b>	0.044

#### Polarised reflex system

Sensing dist. (Sn) m	Function	Output	Connection	Reference	Weight kg
1 with 50 x 50 mm reflector	NO/NC depending on wiring	PNP	Pre-cabled (L = 2 m)	<b>XUYB989SP (1)</b>	0.093
			M8 connector	<b>XUYBCO989SP (1)</b>	0.061
		NPN	Pre-cabled (L = 2 m)	<b>XUYB989SN (1)</b>	0.093
			M8 connector	<b>XUYBCO989SN (1)</b>	0.061

(1) 50 x 50 mm reflector (XU1111) and multi-adjustment fixing bracket included with sensor.

#### Accessory

Accessory	For use with	Weight kg
Reflector, 50 x 50 mm	<b>XUYB989S●</b> <b>XU1111</b>	0.018

#### Thru-beam system

Sensing dist. (Sn) m	Function	Output	Connection	Reference	Weight kg
4 (Transmitter)	-	-	Pre-cabled (L = 2 m)	<b>XUYE989</b>	0.075
			M8 connector	<b>XUYECO989</b>	0.044
4 (Receiver)	NO/NC depending on wiring	PNP	Pre-cabled (L = 2 m)	<b>XUYR989SP</b>	0.075
			M8 connector	<b>XUYRCO989SP</b>	0.044
		NPN	Pre-cabled (L = 2 m)	<b>XUYR989SN</b>	0.075
			M8 connector	<b>XUYRCO989SN</b>	0.044

#### Applications:

- Monitoring position or presence of parts, with background suppression
- Detection of height of objects on a conveyor
- Detection of product, pellet, powder levels.

## Dimensions

### XUYP989S●

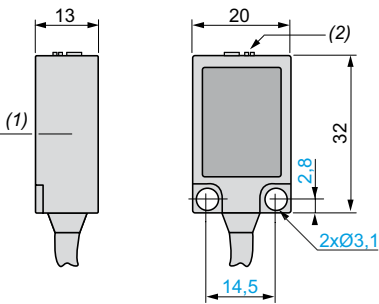

### XUYE989 and XUYR989●●

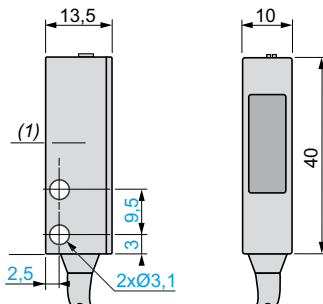

### XU1111

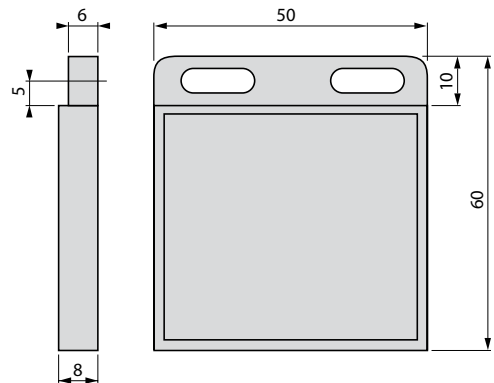

### XUY●989S●

#### Transmitter/Receiver

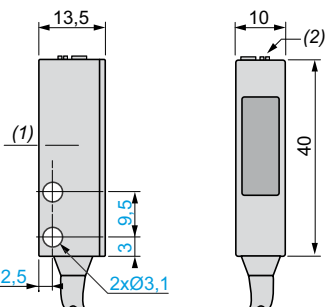

(1) Optical axis  
(2) Accuracy adjustment

Characteristics		XUY●●●●●	XUY●CO●●●●●
Sensor type		CE, cULus (1)	
Product certifications		-	
Connection	Connector		M8, 4-pin, on 0.2 m flying lead
	Pre-cabled	Length: 2 m	-
Nominal sensing distance (Sn)	m	0.08 diffuse with background suppression	
	m	0.25 diffuse with adjustable sensitivity	
	m	1 polarised reflex (with 50 x 50 mm reflector)	
	m	4 thru-beam	
Type of transmission	LED	Red, pulsed	
	Modulation frequency	6 kHz (4 kHz for XUYPS●●989S●)	
Degree of protection	Conforming to IEC 60529	IP 65 and IP 67	
Ambient air temperature	For storage	°C	-20...+80
	For operation	°C	0...+50
Materials	Case	ABS	
	Lens	PMMA	
	Cable	PVC	PUR
Immunity to ambient light	Natural light	Lux	10 000 (insensitive for XUYPS●●989S●)
	Incandescent bulb	Lux	5000 (insensitive for XUYPS●●989S●)
Rated supply voltage		V	≐ 12...24 with protection against reverse polarity
Voltage limits (including ripple)		V	≐ 10...30
Current consumption, no-load		mA	< 25
Switching capacity per output		mA	100 with overload and short-circuit protection
Voltage drop, closed state		V	At 100 mA: < 2; at 10 mA: < 1
Maximum switching frequency		Hz	500
Delays	Response and recovery	ms	1

(1) This product is UL Listed if supplied by a class II or isolated supply delivering ≐ 30 V max. (isolated transformer for example) and protected by a UL fuse rated at 3 A max.

**Wiring scheme - connector**

M8	Pin n° - colour
	<b>1 BN:</b> Brown
	<b>2 WH:</b> White
	<b>3 BU:</b> Blue
	<b>4 BK:</b> Black

**Transmitter**

BN	≐ 10-30 V	Nc: Not connected
BK	Nc	
WH	Nc	
BU	0 V	

**Wiring scheme - pre-cabled**

Diffuse		Polarised reflex and thru-beam	
PNP output	NPN output	PNP output	NPN output

**Application examples**

Access control	Monitoring metal rods	Detection of tin cans on a conveyor

# Photo-electric sensors

OsiSense XU Application, assembly series  
Miniature design  
with laser transmission and teach mode  
Three-wire DC, solid-state output

## Miniature design

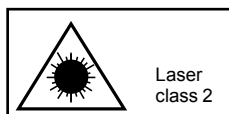

Laser class 2, conforming to IEC 825-1.  
Visible laser radiation: do not stare into beam.

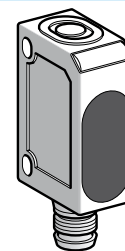
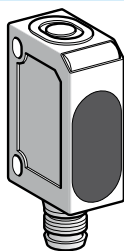

System	Polarised reflex	Diffuse with background suppression	Colour mark reader
Type of transmission	Red laser, pulsed, Class 2, wavelength: 655 nm		
Nominal sensing distance (Sn)	100...1000 mm (1)	20...60 mm	30...110 mm 40...150 mm

## References

4-wire, PNP output	NO/NC function, selectable	XUYBCO929LSP	XUYPCO929L1SP	XUYPCO929L2SP	XUYPCO929LSP
Weight (kg)		0.056	0.056	0.056	0.056

## Characteristics

Product certifications		CE		
Ambient air temperature	For operation	- 20...+ 60 °C		
	For storage	- 20...+ 80 °C		
Degree of protection	Conforming to IEC 60529	IP 67		
Connection		M8, 4-pin male connector		
Vibration resistance	Conforming to IEC 60068-2-6	7 gn, amplitude ± 1.5 mm (f = 10 to 55 Hz)		
Shock resistance	Conforming to IEC 60068-2-27	30 gn, duration 11 ms		
Materials	Case	ABS		
Rated supply voltage		--- 12...24 V with protection against reverse polarity		
Voltage limits (including ripple)		--- 10...30 V		
Immunity to ambient light		5000 lux		
Laser transmission		T pulse: 3 µs, pulse frequency: 5 kHz		
Spot diameter		< 0.7 mm	< 0.3 ...40 mm	< 0.7 mm
Switching capacity		100 mA with overload and short-circuit protection		
Voltage drop, closed state		< 2.4 V		
Current consumption, no-load		25 mA	30 mA	25 mA
Maximum switching frequency		1000 Hz		
Indicator lights	Supply on/Dirty	Green LED		
	Output signal	Yellow LED		
Adjustment		Using teach mode button or remote teaching (external input)		

(1) With 50 x 50 mm reflector, reference XUY1111.

- Applications
- Monitoring of small parts on production machines
- Setting-up of sensors

## Accessories

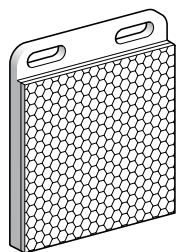

XUY1111

Description	Details	Length of cable	References	Weight
		m		kg
Pre-wired M8 connector	Straight	2	XZCP0941L2	0.080
	Elbowed (90°)	2	XZCP1041L2	0.080
	Straight	5	XZCP0941L5	0.180
	Elbowed (90°)	5	XZCP1041L5	0.180
Reflector for XUYBCO929LSP	50 x 50 mm	–	XUY1111	0.018
Fixing bracket			XUY929	0.013
Protection bracket	Vertical rear fixing		XUY9291	0.070
	Lower side fixing		XUY9292	0.061

## Description

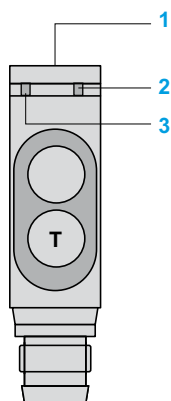

### XUYBC0929LSP

- 1 Teach In (T.I.)
- 2 Yellow LED: Detection LED (1)
- 3 Green LED: Supply on or fault due to accumulation of dirt (if LED off)

- **Teach mode** (yellow and green LEDs are on)
  - Line up with reflector, press T.I. for 3 seconds: both LEDs flash
  - Insert the object, press T.I. for 1 second: the green LED flashes then remains on (teaching completed).

### XUYPC0929L●SP, XUYPC0929LSP

- 1 Teach In (T.I.)
- 2 Yellow LED: Detection LED (2)
- 3 Green LED: Supply on or fault due to accumulation of dirt (if LED off)

- **Teach mode** (yellow and green LEDs are on)
  - Line-up with object, press T.I. for 3 seconds: both LEDs flash
  - Insert the object, press T.I. for 1 second: the green LED flashes then remains on (teaching completed)

R: Receiver  
T: Transmitter

- NO/NC**
- Press T.I. for 13 seconds: the two LEDs alternatively flash (on the release of T.I., the green LED remains on).
  - Each press on T.I. changes the output state (NO, NC, NO, NC, ...). When T.I. is not pressed for 10 seconds, the green LED goes off: the selected state is memorised.

(1) Whether the output is direct or inverse, the "detection" LED goes off only on beam break.  
(2) Whether the output is direct or inverse, the "detection" LED comes on only when an object is present.

## Dimensions

### XUYBC0929LSP, XUYPC0929L●SP

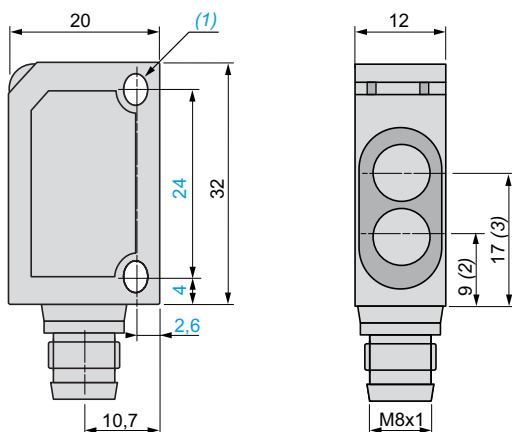

(1) 2 elongated holes  $\varnothing 3.2 \times 4.2$ .  
(2) Transmitter optical axis.  
(3) Receiver optical axis.

## Wiring schemes

### Pre-cabled

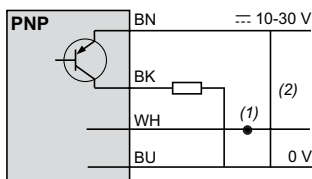

(1) - Connected to +: external teaching,  
- Connected to -: locking of functions  
(2) Output 100 mA max.

### M8 connector



#### Pin n° - colour

- 1 BN: Brown
- 2 WH: White
- 3 BU: Blue
- 4 BK: Black

## Application examples

### Detection of pharmaceutical ampoules

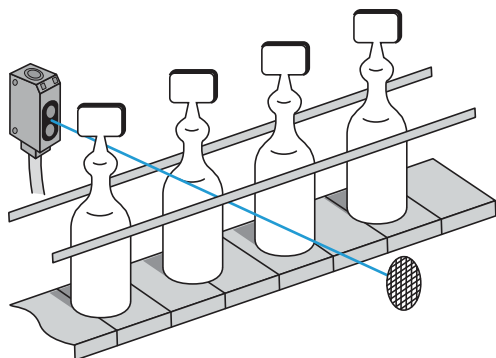

### Detection of connection tags on integrated circuits passing on rail

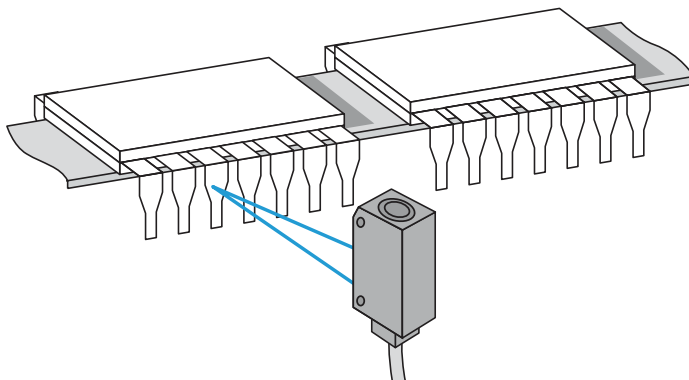

# Photo-electric sensors

OsiSense XU Application, single mode  
Assembly series  
Plastic, M12 connector  
DC

## Compact design

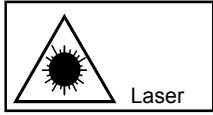

Class 1 or class 2 laser,  
conforming to IEC 60825-1  
Visible laser radiation:  
do not stare into beam

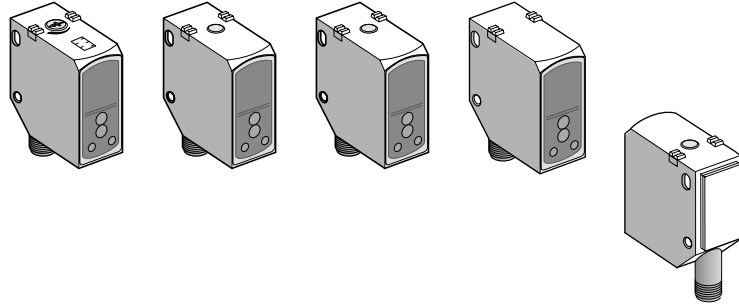

System	Diffuse with background suppression	Diffuse	Polarized reflex	Thru-beam
Type of transmission	Red laser (655 nm) class 1	Red laser (650 nm) class 2	Red laser (655 nm) class 1	Red laser (655 nm) class 1
Nominal sensing distance (Sn)/Maximum sensing distance	5...800 mm, on white 90% (1) 10...600 mm, on grey 18% 30...500 mm, on black 6% (2)	5...1200 mm, on white 90% 10...700 mm, on grey 18% 100...400 mm, on black 6% (2)	0.3...12/14 m (with reflector XUZC50HP)	0...25/30 m

## References

4-wire, PNP NO/NC programmable	XUK8LAPPNM12	XUK5LAPSMM12	XUK9LAPSMM12	Transmitter: XUK2LAKSMM12T	Receiver: XUK2LAPSMM12R
Weight (kg)	0.035	0.035	0.035	0.035	0.035

## Characteristics

Product certifications	CE					
Connection	M12, 4-pin connector					
Degree of protection	Conforming to IEC 60529	IP 67				
	Conforming to DIN 40050	IP 69K				
Ambient air temperature	For operation	-20...+60°C				
	For storage	-20...+80°C				
Material	Case	PC - ABS anti-shock				
	Lenses	PMMA				
Vibration resistance	Conforming to EN/IEC 60068-2-6	Amplitude ±0.5 mm (f = 10 to 55 Hz)				
Shock resistance	Conforming to EN/IEC 60068-2-27	30 gn, duration 11 ms				
Indicator lights	Output state	Yellow LED	Yellow LED	Yellow LED	–	Yellow LED
	Instability/alignment	Yellow LED, flashing/–			–/–	Yellow LED, flashing/ Red LED
	Supply on	Green LED				
Rated supply voltage	12...30 V $\overline{\text{DC}}$		10...30 V $\overline{\text{DC}}$			
Voltage limits (including ripple)	10.8...33 V $\overline{\text{DC}}$ /9...33 V $\overline{\text{DC}}$					
Current consumption, no-load	< 30 mA					
Switching capacity	≤ 100 mA, with protection against reverse polarity and short-circuit					
Test function	Breaking red beam	–	–	–	Yes	–
Voltage drop, closed state	≤ 2.4 V					
Maximum switching frequency	1000 Hz	600 Hz	2000 Hz	–	3500 Hz	
Delays	First-up	< 300 ms				
	Response	0.5 ms	0.8 ms	0.25 ms	–	0.14 ms
	Recovery	0.5 ms	0.8 ms	0.25 ms	–	0.14 ms

(1) On the minimum setting, the background suppression distance (white) is 70 mm.  
(2) % of object remission.

**References of accessories**

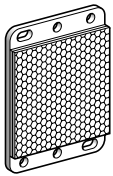

XUZC50HP

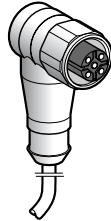

XZCPA1241L5

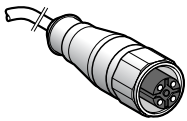

XZCPA1141L5

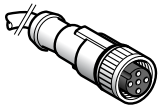

XZCP1141L5

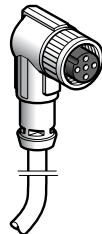

XZCPA1241L5

Description	Dimensions	Reference	Weight kg
<b>Fixing bracket</b> 304 stainless steel	–	<b>XUZA51S</b>	0.050
<b>Protection bracket</b> 304 stainless steel	–	<b>XUZASK001</b>	0.210
<b>Mounting bracket on dovetail</b>	–	<b>XUZASK002</b>	0.050
<b>Rigid microprism reflector</b>	50 x 50 mm	<b>XUZC50HP</b>	0.020

**Pre-wired connectors with PVC cable for food and beverage applications**

<b>Straight pre-wired connector</b> M12, 4-pin, female connector, stainless steel clamping ring	5 m	<b>XZCPA1141L5</b>	0.210
<b>Elbowed pre-wired connector</b> M12, 4-pin, female connector, stainless steel clamping ring	5 m	<b>XZCPA1241L5</b>	0.210

**Pre-wired connectors with PUR cable for industrial applications**

<b>Straight pre-wired connector</b> M12, 4-pin, female connector, nickel-plated brass clamping ring	5 m	<b>XZCP1141L5</b>	0.210
<b>Elbowed pre-wired connector</b> M12, 4-pin, female connector, nickel-plated brass clamping ring	5 m	<b>XZCP1241L5</b>	0.210

**Note:** To find other connection accessories, please consult our catalogue "OsiSense XZ cabling accessories".

**Curves**

**XUK8LAPPN12**

**Scanning properties**

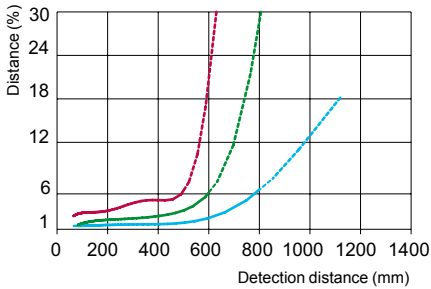

— Black/white 6%/90%  
— Grey/white 18%/90%  
— White/white 90%/90%

**Size of luminous point**

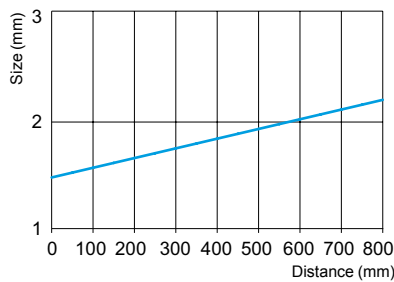

**XUK5LAPSM12**

**Excess gain curve**

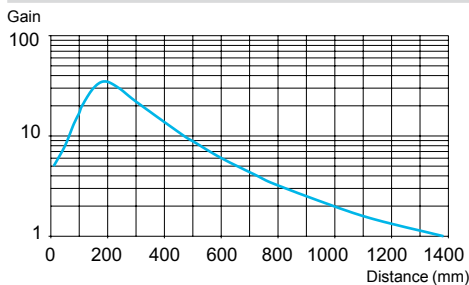

**Size of luminous point**

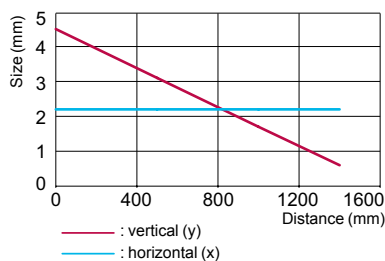

— : vertical (y)  
— : horizontal (x)

**Curves (continued)**

**XUK9LAPSMM12**

**Excess gain curve**

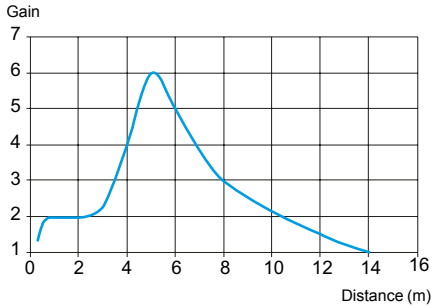

**Size of luminous point**

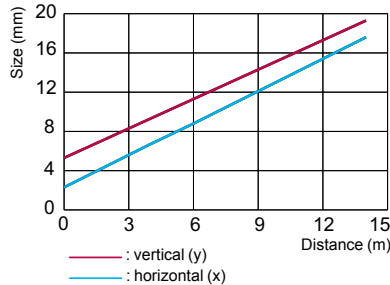

**XUK2LAKSMM12T and XUK2LAPSMM12R**

**Excess gain curve**

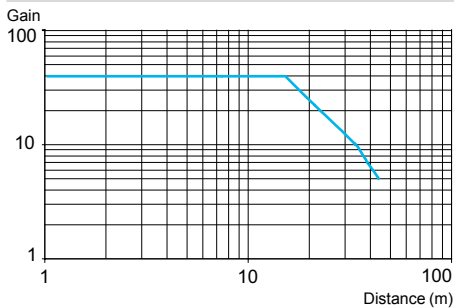

**Size of luminous point**

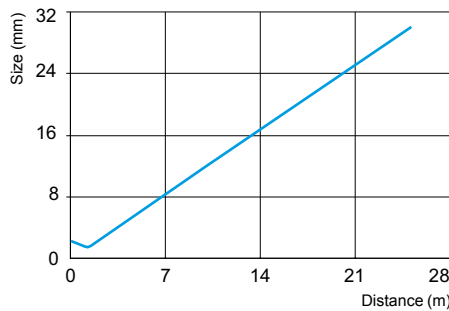

**Wiring schemes using M12 connector**

**XUK8LAPPNM12**



- 1 BN: Brown (+)
- 2 WH: White
- (+UB = NC, -UB = NO, not connected = NO)
- 3 BU: Blue (-)
- 4 BK: Black (Output)

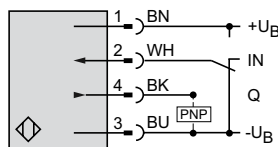

**XUK5LAPSMM12, XUK9LAPSMM12 and XUK2LAPSMM12R**



- 1 BN: Brown (+)
- 2 WH: White (ET/Lock) (1)
- 3 BU: Blue (-)
- 4 BK: Black (Output)

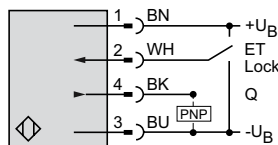

**XUK2LAPSMM12T**



- 1 BN: Brown (+)
- 2 WH: White (Test input) (2)
- 3 BU: Blue (-)
- 4 BK: Black (pin not connected)

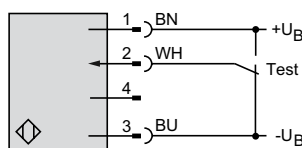

(1) ET/Lock. ET: External Teach, Lock: pushbutton locking.

+ UB: external teach. - UB: pushbutton locking.

Not connected: normal operation.

(2) Test input: + UB = test function (transmitter disconnected). - UB or not connected = normal operation.



## Dimensions

### Sensors

#### XUK8LAPPNM12

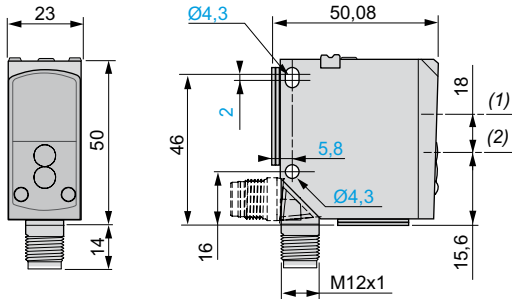

#### XUK2LAKSMM12T and XUK2LAPSMM12R

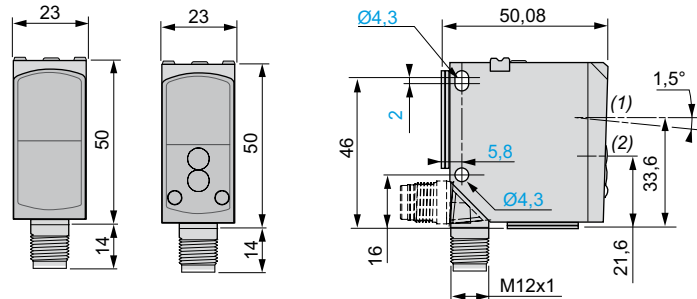

### Sensors (continued)

#### XUK5LAPSMM12 and XUK9LAPSMM12

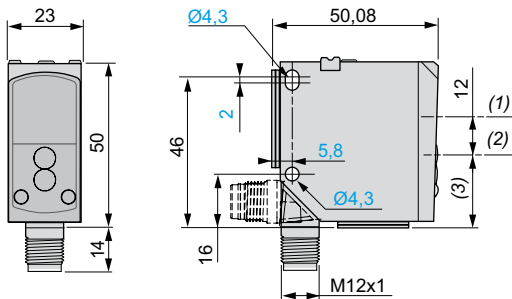

### Reflector

#### XUZC50HP

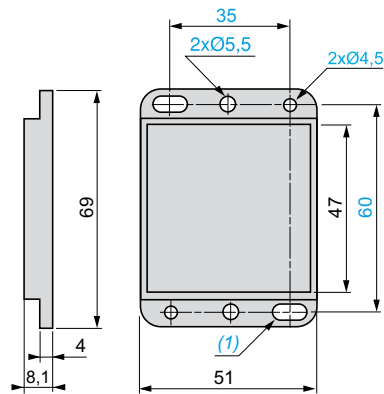

- (1) Receiver optical axis.
- (2) Transmitter optical axis.
- (3) 21.4 mm for XUK5LAPSMM12,  
21.6 mm for XUK9LAPSMM12.

- (1) 2 elongated holes for M4 screws.

## Photo-electric sensors

OsiSense XU Application, conveying series

For detecting packages on a roller conveyor

DC supply, solid-state output

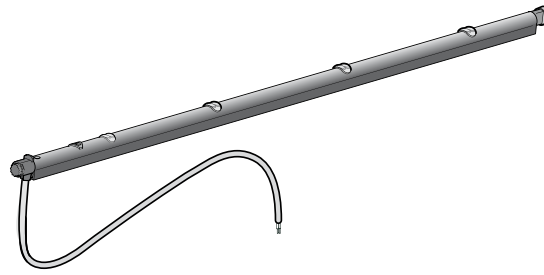

Nominal sensing distance (Sn)	0.1 m
Function	NO/NC programmable
Output	PNP + NPN
Connection	Remote M12 connector, L = 0.3 m

### References

3-wire type	XUY474NB4H03M12 (1)
Number of sensors (1 to 6)	4
Weight (kg)	0.075

**Note:** If you require more information about these products, please consult our Customer Care Centre.

### Characteristics

Product certifications		CE, cCSAus
Type of transmission		Infrared
Operating mode		Diffuse
Nominal sensing distance		100 mm (white paper)
Differential travel		< 25%
Degree of protection	Conforming to IEC 60529	IP 50 (IP 65 on request)
Ambient air temperature	For operation	- 10...+ 55°C
	For storage	- 20...+ 80°C
Vibration resistance	Conforming to EN/IEC 60068-2-8	For X, Y and Z: 1 mm from 10 to 42 Hz 7 gn from 42 to 55 Hz 30 mm at resonant frequency or 55 Hz
Shock resistance	Conforming to EN/IEC 60068-2-27	For X, Y and Z: 10 gn for 11 ms
Material	Case	Aluminium and PA
	Lenses	PC
Rated supply voltage		24 V with protection against reverse polarity
Voltage limits (including ripple)		18...30 V of rated operational voltage
Switching capacity		100 mA with overload and short-circuit protection
Voltage drop, closed state		≤ 2 V
Current consumption		≤ 35 mA
Maximum switching frequency		500 Hz
Delay		1 ms response 1 ms recovery
Indicator lights	Output state	1 yellow LED
Detection accuracy		2 mm at 2 m/s

(1) These sensors are suitable for use on a 473-477 mm wide conveyor frame (-1, + 3 mm). Other possible widths are given on the next page.

# Photo-electric sensors

OsiSense XU Application, conveying series

For detecting packages on a roller conveyor

DC supply, solid-state output

## References of accessories

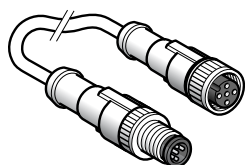

XZCR1511041C

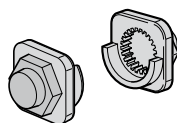

XUZASY01H

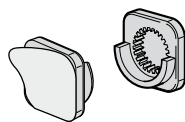

XUZASY01A

Description	Length m	Reference	Weight kg
<b>Fixing accessories</b>			
Pack of 20 hexagonal supports and Ø 8 mm fixing	–	XUZASY01H	0.020
Pack of 20 self-adhesive hexagonal supports	–	XUZASY01A	0.020
<b>M12-M12 jumper cables</b>			
4-pin, straight connector	1	XZCR1511041C1	0.065
	2	XZCR1511041C2	0.095
4-pin, elbowed connector	1	XZCR1512041C1	0.065
	2	XZCR1512041C2	0.095

## Connections

### M12 connector



#### Pin no./colour

- 1 BN: Brown
- 2 WH: White (disconnected)
- 3 BU: Blue
- 4 BK: Black

### PNP + NPN programmable, NO or NC output

#### PNP, NO output

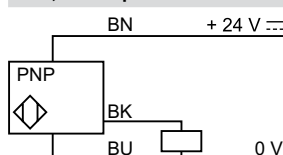

#### PNP, NC output

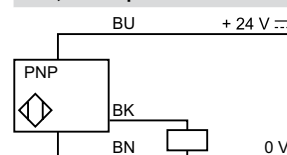

#### NPN, NO output

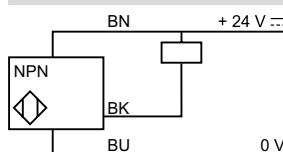

#### NPN, NC output

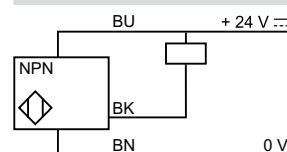

## Dimensions (mm)

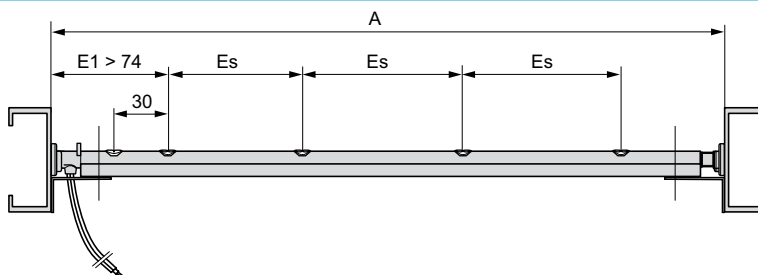

A: Conveyor width exact distance between lips (250 to 900 mm).

For dimensions above 900 mm, please consult our Customer Care Centre.

## Examples of components in the references

	Conveyor width (A)	Additional functions (1)	Spacing between sensors (Es)	Number of sensors	Fixing type	Connection
XUY380NA5D03M8	380 mm	No	54 mm	5	Ø 8 mm	Remote M8 connector with 0.3 m cable
XUY410NC3H1M12	410 mm	No	108 mm	3	11.2 mm hexagonal support	Remote M12 connector with 1 m cable
XUY450NB3N03M8	450 mm	No	93.1 mm	3	–	Remote M8 connector with 0.3 m cable
XUY600NC5H2	600 mm	No	108 mm	5	11.2 mm hexagonal support	2 m cable
XUY707ND4P2	707 mm	No	162 mm	4	Hexagonal support on each side	2 m cable

(1) Timer, special settings, IP65 degree of protection: on request from our Customer Care Centre.

# Photo-electric sensors

OsiSense XU Application, conveying series

For detecting packages on a roller conveyor

DC supply, solid-state output

## Detection curves

### Conveyor axis - Load running direction

Distance between the target and the sensor in mm

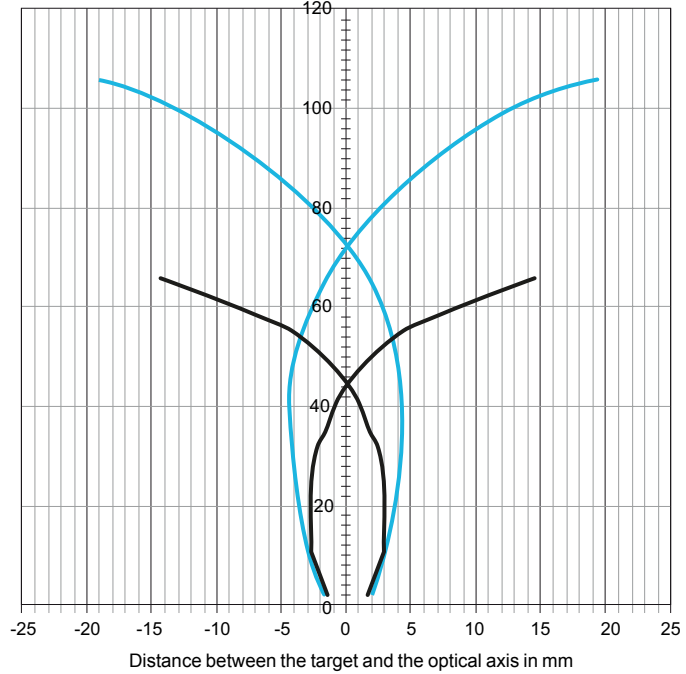

— : Black 6%  
 — : White 92%

### Roller axis - Direction at right-angles to load running

Distance between the target and the sensor in mm

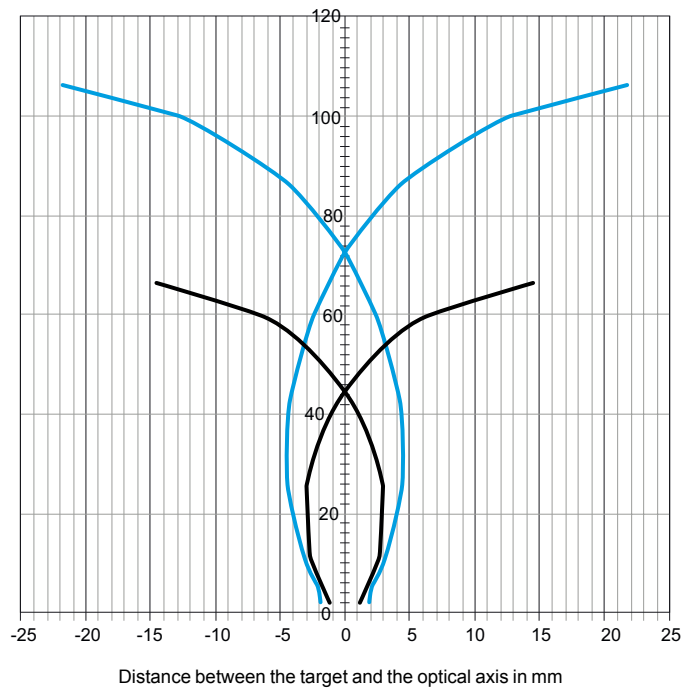

— : Black 6%  
 — : White 92%

# Photo-electric sensors

OsiSense XU Application, conveying series

For detecting packages on a roller conveyor

DC supply, solid-state output

## Mounting

Mounting on the sides, with XUZASY01H or XUZASY01A hexagonal supports  
(2 of each support are supplied with the sensor)

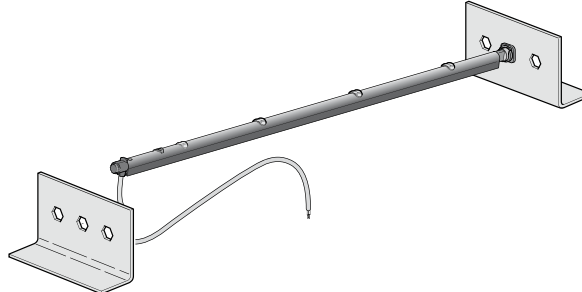

Mounting underneath (brackets, screws and nuts not supplied)

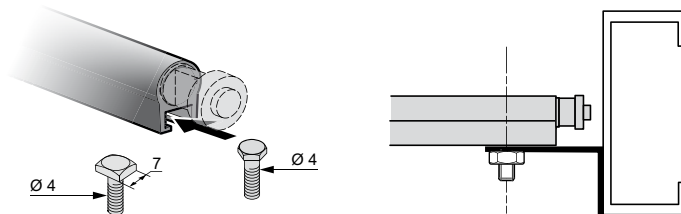

## Mounting precautions

Recommended mounting

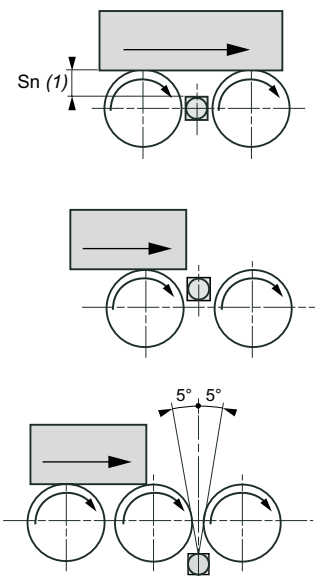

Not recommended

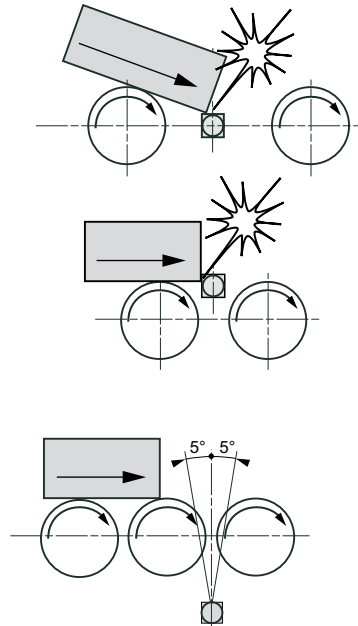

(1)  $S_n \leq 100 \text{ mm}$ .

## Application example

Package detection - sensor mounted between motorized rollers

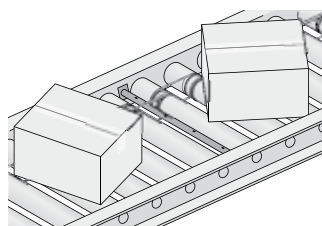

# Photo-electric sensors

OsiSense XU Application, material handling series

Laser transmission. Design 18, plastic or metal  
Three-wire DC. Solid-state output

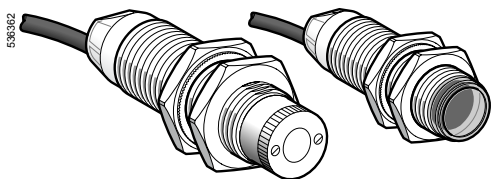

XUBL●●CNL2

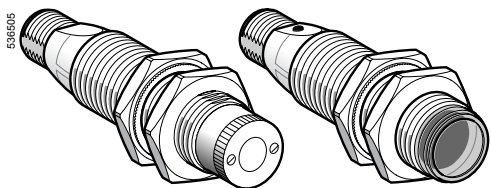

XUBL●●CNM12

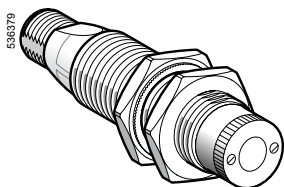

XUBL●●CNM12T

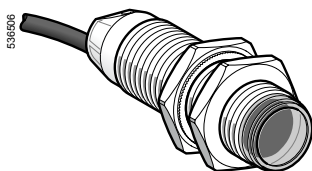

XUBL●●CNL2R

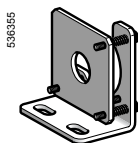

XUZA318

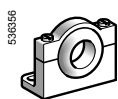

XUZA218



XUZA118

## Ø 18, plastic, thru-beam system with teach mode, laser transmission (Transmitter + receiver)

Sensing distance (Sn) m	Function	Connection	Output	Reference	Weight kg
0...100	NO or NC, by programming	Pre-cabled	PNP	XUBLAPCNL2	0.180
			NPN	XUBLANCNL2	0.180
		M12 connector	PNP	XUBLAPCNM12	0.078
			NPN	XUBLANCNM12	0.078

## Ø 18, metal, thru-beam system with teach mode, laser transmission (Transmitter + receiver)

Sensing distance (Sn) m	Function	Connection	Output	Reference	Weight kg
0...100	NO or NC, by programming	Pre-cabled	PNP	XUBLBPCNL2	0.230
			NPN	XUBLBNCNL2	0.230
		M12 connector	PNP	XUBLBPCNM12	0.130
			NPN	XUBLBNCNM12	0.130

## Separate components

### Ø 18 transmitter

Description	Connection	Output	For use with	Reference	Weight kg
Plastic	Pre-cabled	–	XUBLA●●CNL2	XUBLAKCNL2T	0.090
	M12 connector	–	XUBLA●●CNM12	XUBLAKCNM12T	0.040
Metal	Pre-cabled	–	XUBLB●●CNL2	XUBLBKCNL2T	0.110
	M12 connector	–	XUBLB●●CNM12	XUBLBKCNM12T	0.060

### Ø 18 receiver

Description	Connection	Output	For use with	Reference	Weight kg
Plastic	Pre-cabled	PNP	XUBLAPCNL2	XUBLAPCNL2R	0.090
		NPN	XUBLANCNL2	XUBLANCNL2R	0.090
	M12 connector	PNP	XUBLAPCNM12	XUBLAPCNM12R	0.040
		NPN	XUBLANCNM12	XUBLANCNM12R	0.040
Metal	Pre-cabled	PNP	XUBLBPCNL2	XUBLBPCNL2R	0.120
		NPN	XUBLBNCNM12	XUBLBNCNL2R	0.120
	M12 connector	PNP	XUBLBPCNM12	XUBLBPCNM12R	0.070
		NPN	XUBLBNCNM12	XUBLBNCNM12R	0.070

## Fixing accessories for XUBL● (1)

Description	Reference	Weight kg
Precision fixing bracket with micrometric adjustment	XUZA318	0.170
Plastic fixing bracket with adjustable ball-joint	XUZA218	0.035
Stainless steel fixing bracket	XUZA118	0.045

## Dimensions

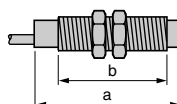

	Pre-cabled (mm)		Connector (mm)	
	a	b	a	b
Receiver (2)	62	44	76	44
Transmitter (3)	52	28	66	28

(1) For further information, see page 162

(2) Yellow, green and red LED on receiver

(3) Green LED on transmitter

**Note:** fixing nut tightening torque: < 4 Nm

# Photo-electric sensors

OsiSense XU Application, material handling series

Laser transmission. Design 18, plastic or metal  
Three-wire DC. Solid-state output

Characteristics			XUBL●●●●M12	XUBL●●●●L2
Sensor type				
Product certifications			UL, CSA, CE	
Connection	Connector		M12	-
	Pre-cabled		-	Length: 2 m
Nominal sensing distance Sn			m 0...100, excess gain 70...3	
Blind zone			0	
Preferred object approach direction			Any	
Type of transmission			Red laser, wavelength 670 nm	
Transmission power			Power < 1 mW, class 1 conforming to IEC 60825-1	
Degree of protection			Conforming to IEC 60529 IP 67, double insulation	
Temperature	Storage	°C	- 40... + 70	
	Operation	°C	- 10... + 45	
Materials	Case		XUBLA●●●●●: PBT; XUBLB●●●●●: nickel plated brass	
	Lens		PMMA	
Vibration resistance			Conforming to IEC 60068-2-6 7 gn, amplitude ± 1.5 mm (f = 10 to 55 Hz)	
Shock resistance			Conforming to IEC 60068-2-27 30 gn, duration 11 ms	
Indicator lights	Output state and alignment aid		Yellow LED	
	Supply on and teaching		Green LED	
	Stability		Red LED	
Rated supply voltage			V --- 12...24 with protection against reverse polarity	
Voltage limits (including ripple)			V --- 10...30	
Current consumption, no-load			mA 25 for transmitter or receiver	
Switching capacity per output			mA ≤ 100 with overload and short-circuit protection	
Voltage drop, closed state			V ≤ 1.5	
Maximum switching frequency			Hz 1500	
Delays	First-up	ms	< 80	
	Response and recovery	ms	< 0.4	

## Wiring schemes

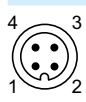
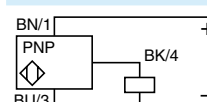
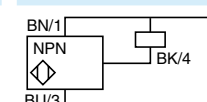
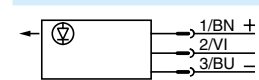
M12 connector	Pre-cabled	PNP	NPN	Transmitter
 <p>3 (-) 1 (+) 4 OUT/Output 2 Beam break input</p>	<p>(-) BU (Blue) (+) BN (Brown) OUT/Output BK (Black) Beam break input VI (Violet)</p>	 <p>BN/1 + BK/4 BU/3 -</p>	 <p>BN/1 + BK/4 BU/3 -</p>	 <p>1/BN + 2/VI 3/BU -</p> <p>Input 2/VI: - not connected: beam made - connected to -: beam broken</p>

## Curves

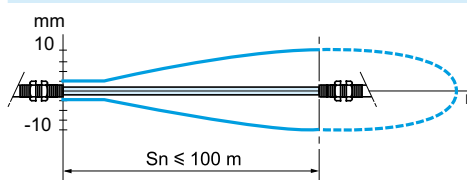
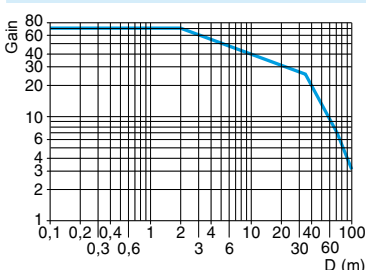
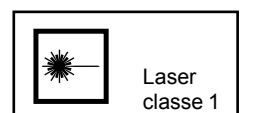
Detection curve (set to infinity)	Excess gain curve	Operating precautions
 <p>Sn ≤ 100 m</p>		 <p>Laser class 1</p> <p>Laser class 1, conforming to IEC 60825-1.</p>

## Adjustment

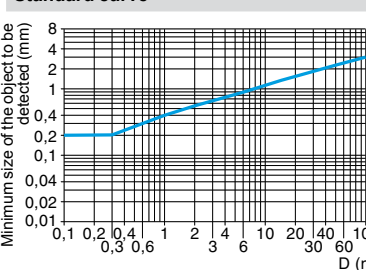
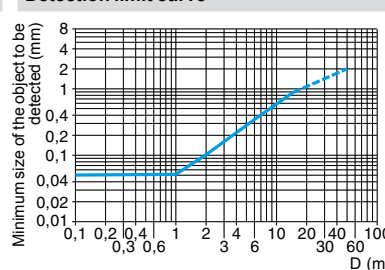
Standard curve	Detection limit curve
	

The adjustment of the focusing point enables the detection of objects down to a size of < 0.2 mm. After slackening the fixing screws 1, adjust the focusing point of the laser beam by rotating the serrated sleeve 2 located on the face of the sensor. Re-tighten fixing screws.

**Note:** fixing bracket **XUZA218** with ball-joint and, in particular, bracket **XUZA318** with precise micrometric adjustment and locking by 6 screws, are specially suited for mounting the sensor and adjusting beam alignment when the sensing range is several tens of metres (see page 164).

# Photo-electric sensors

OsiSense XU Application, material handling series

With analogue output signal 4...20 mA and 0...10 V <sup>(1)</sup>

DC supply. Solid-state output

## Compact design

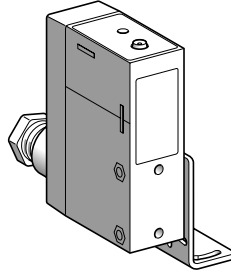

<b>System</b>		Diffuse
<b>Type of transmission</b>		Infrared
<b>Nominal sensing distance (Sn)</b>		20...80 cm
<b>References</b>		
<b>3-wire</b>	<b>PNP</b>	<b>XUJK803538</b>
<b>Weight (kg)</b>		0.200
<b>Characteristics</b>		
<b>Product certifications</b>		CE, CSA, UL
<b>Ambient air temperature</b>	For operation	- 25...+ 60 °C
	For storage	- 40...+ 80 °C
<b>Vibration resistance</b>	Conforming to IEC 60068-2-6	7 gn, amplitude ± 1.5 mm (f = 10...55 Hz)
<b>Shock resistance</b>	Conforming to IEC 60068-2-27	20 gn, duration 11 ms
<b>Degree of protection</b>	Conforming to IEC 60529	IP 67
	Conforming to NF C 20-010	IP 671
<b>Connection</b>		Screw terminals, maximum capacity: 2 x 1.5 mm <sup>2</sup> or 1 x 2.5 mm <sup>2</sup>
<b>Materials</b>		Case: PEI <sup>(2)</sup>
<b>Rated supply voltage</b>		~ 24 V with protection against reverse polarity
<b>Voltage limits (including ripple)</b>		~ 20...30 V
<b>Output current</b>	Maximum	20 mA
	Minimum	4 mA
<b>Output voltage (Vs)</b>		~ 0...10 V
<b>Output voltage drift in relation to temperature</b>		< 10% between - 25 and + 60 °C
<b>Output voltage drift in relation to object colour</b>		< 10%
<b>Current consumption, no-load</b>		≤ 35 mA
<b>Maximum switching frequency</b>		10 Hz (for an output voltage variation of 1 V)
<b>Delays</b>	First-up	≤ 150 ms
<b>Indicator light</b>		The brightness of the LED is proportional to the output voltage

<sup>(1)</sup> Applications: position control, monitoring concentricity or eccentricity, closed loop regulation, monitoring displacement, etc.

<sup>(2)</sup> PEI: high quality synthetic resin providing excellent withstand to mechanical shocks, vibration and the effects of external agents frequently encountered in industry: alcohol, salts, petroleum, oils, greases, washing agents (diluted sodium carbonate 4%, nitric acid 2%), formaldehyde vapour, splashing lactic acid, etc.



# Photo-electric sensors

OsiSense XU Application, material handling series

With analogue output signal 4...20 mA and 0...10 V <sup>(1)</sup>  
DC supply. Solid-state output

## Curves

Output signal (related to distance of object). Test performed with 20 x 20 cm, white 90% object

Output current

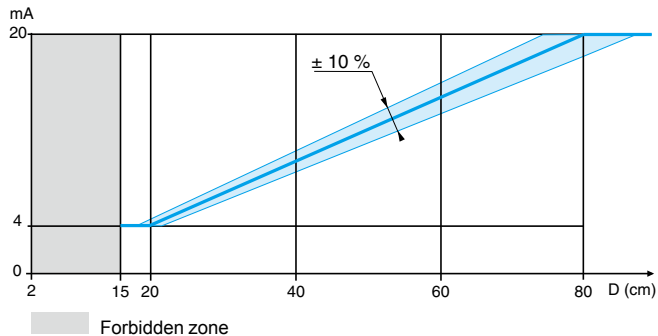

Output voltage

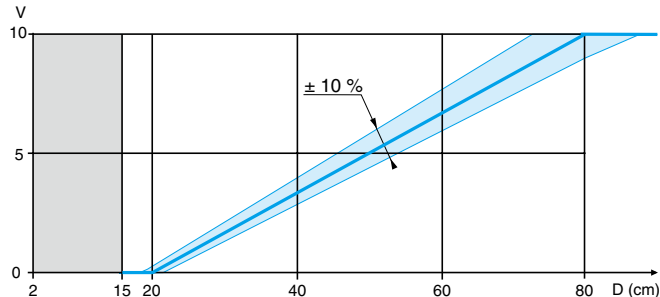

## Dimensions

Sensor XUJK803538 (the bracket XUZA41 is included with the sensor)

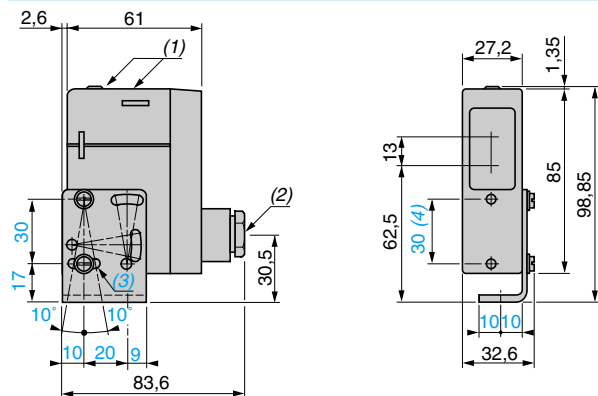

(1) LED.

(2) 11P cable gland.

(3) 1 elongated hole  $\varnothing 4.2 \times 14$ .

(4) Front fixing ( $\varnothing 4$  screws and inserts included).

## Wiring schemes

Diffuse system

Current output

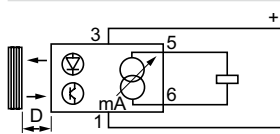

Voltage output

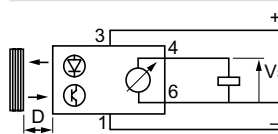

## Load characteristics

- Output current: the output current varies between 4 and 20 mA depending on the distance of the object and therefore, the load must be less than 1 k $\Omega$ .
- Voltage output: since the minimum rated output current of the sensor is 10 mA, the load must always have a resistive value of more than 1 k $\Omega$ .

## Terminal connections

- 1  $\varnothing$  - (-)
- 2  $\varnothing$
- 3  $\varnothing$  - (+)
- 4  $\varnothing$  - Output voltage
- 5  $\varnothing$  - Output current
- 6  $\varnothing$  - (-)

Terminals 1 and 6 connected internally.

# Photo-electric sensors

OsiSense XU Application, material handling series

With analogue output signal 4...20 mA (1)

DC supply

## Design 18

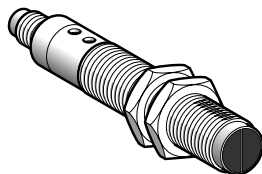

System	Diffuse
Type of transmission	Infrared
Nominal sensing distance (Sn)	5...40 cm

## References

3-wire, PNP	XU5M18AB20D
Weight (kg)	0.075

## Characteristics

Product certifications	CE, CSA, UL
Ambient air temperature	For operation: - 25...+ 55 °C. For storage: - 40...+ 70 °C
Vibration resistance	Conforming to IEC 60068-2-6 25 gn, amplitude ± 2 mm (f = 10...55 Hz)
Shock resistance	Conforming to IEC 60068-2-27 30 gn, duration 11 ms
Degree of protection	Conforming to IEC 60529 IP 67
Connection	M12 male connector, 4-pin (suitable female connectors, including pre-wired versions, please refer to our catalogue "Cabling accessories OsiSense XZ")
Materials	Case: nickel plated brass, lens: PMAA
Rated supply voltage	--- 12...24 V with protection against reverse polarity
Voltage limits	--- 10...30 V (including ripple)
Output current	Maximum 20 mA Minimum 4 mA
Output current drift in relation to temperature	< 10% between - 25 and + 55 °C, < 5% between 0 and + 40 °C
Output current drift in relation to supply	< 3%
Current consumption, no-load	≤ 30 mA
Maximum switching frequency	20 Hz (for an output current variation of 10 mA)
Delays	First-up: ≤ 50 ms
Indicator light	The brightness of the green LED is proportional to the output current Ie = 20 mA: indicator light at maximum intensity Ie = 4 mA: indicator light at minimum intensity

## Fixing accessory (2)

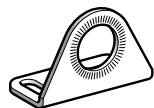

XUZA118

Description	Reference	Weight kg
Stainless steel fixing bracket	XUZA118	0,045

(1) Applications: position control, monitoring concentricity or eccentricity, closed loop regulation, monitoring displacement, etc.

(2) For further information, see page 162.

## Curves

Output signal (related to distance of object)

Potentiometer set at maximum

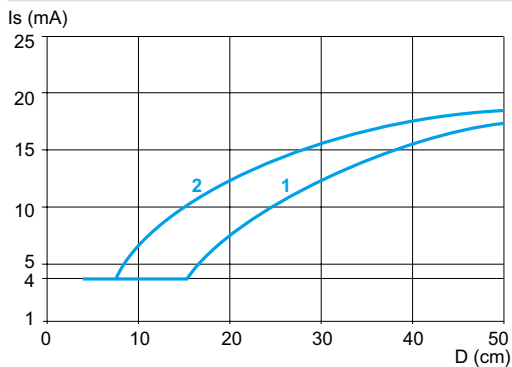

- 1 White 90% object
- 2 Grey 15% object

Potentiometer set at minimum

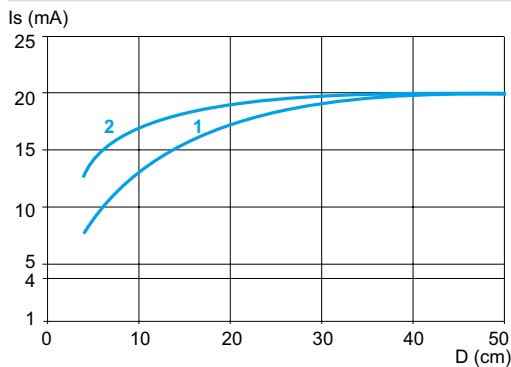

- 1 White 90% object
- 2 Grey 15% object

## Dimensions

Sensor XU5M18AB20D

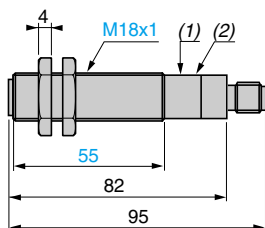

Fixing bracket XUZA118

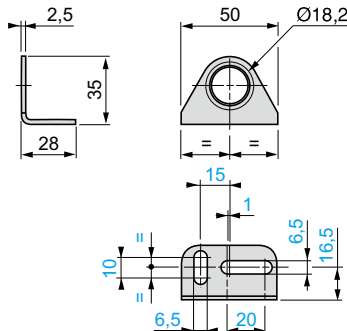

(1) Potentiometer.

(2) Green LED.

Fixing nut tightening torque: 15 N.m.

Connector tightening torque: 2 N.m.

## Schemes

Wiring schemes

Diffuse system

Output current

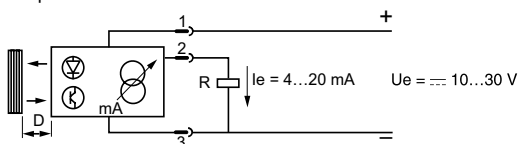

Connector scheme

Sensor connector pin view

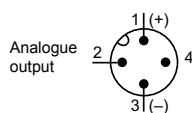

For suitable female connectors, including pre-wired versions, please refer to our catalogue "Cabling accessories OsiSense XZ".

## Load characteristics (R)

The output current varies between 4 and 20 mA, depending on the distance of the object, and therefore, the load must be less than 800 Ω for a 24 V supply and less than 300 Ω for a 12 V supply.

# Photo-electric sensors

OsiSense XU Application

Material handling series

With solid-state and analogue output signal 4...20 mA

Laser transmission

## Design 90 x 90 mm

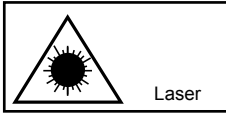

Laser class 1, conforming to IEC 60825-1  
Laser class 2 pointer, conforming to IEC 60825-1

Visible laser radiation:  
do not stare into beam

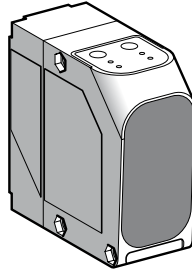

System	Object distance sensor	Reflector distance sensor
Type of transmission	Infrared laser, class 1 (905 nm) Red laser pointer, class 2 (650 nm) (1)	
Measuring distance	0.2...6 m (on white 90%) 0.2...6 m (on grey 18%) 0.2...2.5 m (on black 6%) (2)	0.2...30 m (with reflector XUZC250)

## References

5-wire solid-state outputs (x 2) analog output (x 1)	PNP, 4...20 mA	XUE5AA2NM12	XUE1AA2NM12
Weight (kg)		0.2	0.2

## Characteristics

Product certifications	cULus, C€		
Connection	M12, 5-pin connector		
Degree of protection	Conforming to IEC 60529	IP 67	
Vibration resistance	Conforming to EN/IEC 60947-5-2 and IEC 60947-4-2	Amplitude ±0.5 mm (f = 10 to 55 Hz)	
Shock resistance	Conforming to EN/IEC 60947-5-2 and IEC 60947-4-1	30 gn, duration 11 ms	
Ambient air temperature	For operation	- 20... + 50 °C	
	For storage	- 40... + 80 °C	
Repeat accuracy (analog output) (3)		Fast mode: ± 15 mm Slow mode: ± 10 mm	Fast mode: ± 10 mm Slow mode: ± 5 mm
Fast mode/slow mode (response time)		13 ms/80 ms	
Linearity		≤ ± 40 mm	
Materials	Case	ABS, mechanical shocks resistant	
	Lenses	PMMA	
Rated supply voltage	18...30 V ~		
Voltage limits (including ripple)	±10% of rated operational voltage		
Immunity to ambient light	Conforming to EN/IEC 60947-5-2		
Output signal	Solid-state outputs: 2 x PNP analog output: 4...20 mA		
Light spot size	4 x 7 mm at 2 m 3 x 10 mm at 4 m 4 x 12 mm at 6 m	15 x 20 mm at 10 m 30 x 40 mm at 20 m 45 x 60 mm at 30 m	
Switching capacity	100 mA, with protection against reverse polarity, overload and short-circuit		
Voltage drop, closed state	≤ 2.4 V		
Current consumption, no-load	≤ 125 mA on 24 V ~		
Maximum switching frequency	Fast mode: 38 Hz Slow mode: 16 Hz		
Indicator lights	Output state	2 yellow LEDs	
	Supply on	1 green LED	
	Slow mode	1 orange LED	
	Parametering	4 red LEDs	
Parametering	By 2 buttons: Set and Toggle		

(1) In operating mode, the red laser class 2 pointer can be stopped for working on infrared transmission.

(2) % of object remission.

(3) Information taken into account after 30 minutes.

# Photo-electric sensors

OsiSense XU Application

Material handling series

With solid-state and analogue output signal 4...20 mA

Laser transmission

## References of accessories

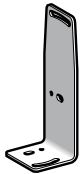

XUZA618

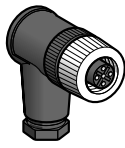

XZCC12FCM50B

Description	For use with	Dimensions (mm)	Reference	Weight kg
Fixing bracket (screws, nuts and washers included)	XUE5AA2NM12 XUE1AA2NM12	-	XUZA618	0.062
Adhesive reflector	XUE1AA2NM12	250 x 250	XZCC250	0.040
Straight connector, wired by user M12, 5-pin female	XUE5AA2NM12 XUE1AA2NM12	-	XZCC12FDM50B	0.020
Elbowed connector, wired by user M12, 5-pin female	XUE5AA2NM12 XUE1AA2NM12	-	XZCC12FCM50B	0.020

## Presentation

Minimum size of detectable object related to distance

XUE5AA2NM12

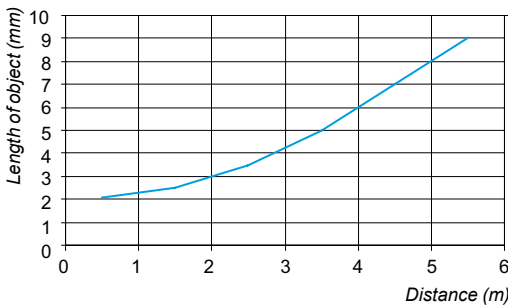

Light spot size (not visible)

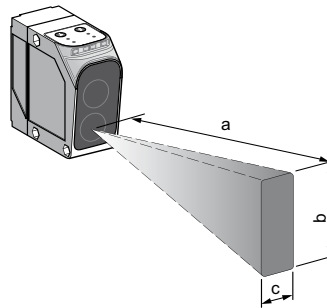

	XUE5AA2NM12				XUE1AA2NM12			
a (m)	0	2	4	6	0	10	20	30
b (mm)	10	7	10	12	10	20	40	60
c (mm)	5	4	3	4	5	15	30	45

Note: Typical values for application involving measurements on a square white object

## Wiring schemes

M12 connector

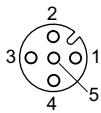

Pin n°/colour

- 1 BN: Brown
- 2 WH: White
- 3 BU: Blue
- 4 BK: Black
- 5 GY: Grey

XUE5AA2NM12

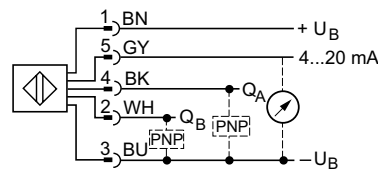

XUE1AA2NM12

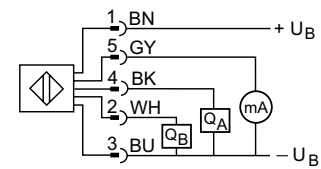

## Dimensions

XUE5AA2NM12 and XUE1AA2NM12

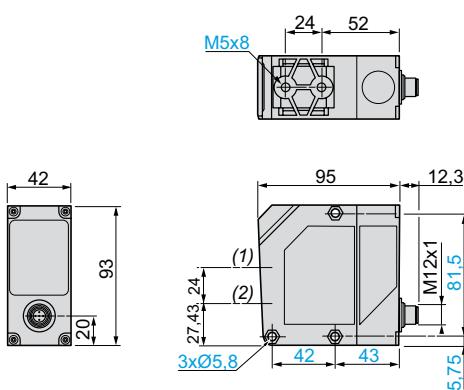

XUE5AA2NM12 and XUE1AA2NM12 with fixing bracket XUZA618

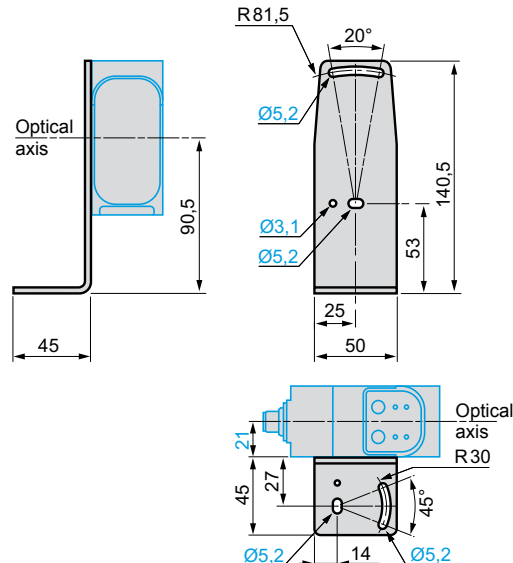

(1) Receiver optical axis.  
(2) Transmitter optical axis.

# Photo-electric sensors

OsiSense XU Application, material handling series

Through beam system with high “excess gain” <sup>(1)</sup>  
Solid-state output and analogue output 4...20 mA

## Design 18

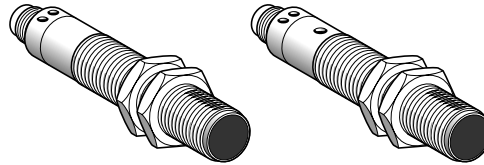

<b>System</b>		<b>Thru-beam</b>
<b>Type of transmission</b>		Infrared
<b>Nominal sensing distance (Sn) / maximum</b>		50 m / 70 m (transmitter + receiver)
<b>References</b>		
<b>3-wire, PNP</b>	NO (object detection) + analogue output	<b>XU2M18AP20D</b> (2)
<b>Weight (kg)</b>		0.155
<b>Characteristics</b>		
<b>Product certifications</b>		CE, CSA, UL
<b>Ambient air temperature</b>	For operation	- 25...+ 55 °C
	For storage	- 40...+ 70 °C
<b>Vibration resistance</b>	Conforming to IEC 60068-2-6	25 gn, amplitude ± 2 mm (f = 10...55 Hz)
<b>Shock resistance</b>	Conforming to IEC 60068-2-27	30 gn, duration 11 ms
<b>Degree of protection</b>	Conforming to IEC 60529	IP 67
<b>Connection</b>		M12 male connector, 4-pin (suitable female connectors, including pre-wired versions, please refer to our catalogue “Cabling accessories OsiSense XZ”)
<b>Materials</b>	Case	Nickel plated brass
	Lenses	PMMA
<b>Rated supply voltage</b>		<b>DC 12...24 V with protection against reverse polarity</b>
<b>Voltage limits</b>		DC 10...30 V (including ripple)
<b>Solid-state digital output</b>	Switching capacity (sealed)	<b>≤100 mA with overload and short-circuit protection</b>
	Voltage drop, closed state	≤ 1.5 V
	Maximum switching frequency	30 Hz
	First-up delay	≤ 50 ms
	Response delay	≤ 15 ms
	Recovery delay	≤ 15 ms
<b>Analogue output</b>	Output current	<b>4...20 mA</b> Drift < 5% for temperature between 0 and + 40 °C
	Delay	≤ 15 ms
<b>Current consumption, no-load</b>		≤ 55 mA (transmitter + receiver)
<b>Indicator lights</b>	Transmitter	Green LED, supply on Yellow LED illuminated = beam transmission
	Receiver	Yellow LED illuminated = solid-state output ON = object detected within beam Green LED: the brightness of the LED is proportional to the output current: - for I = 20 mA, object slightly opaque, intensity at maximum, - for I = 4 mA, object completely opaque, intensity at minimum.

## Fixing accessory (3)

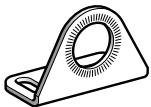

XUZA118

Description	Reference	Weight kg
Stainless steel fixing bracket	XUZA118	0,045

(1) Applications: detection of objects in spite of a difficult environment (smoke, dust, mist, etc.), detection of objects inside packaging, etc.

**Example of values:**

Object: white sheets of 80 gsm paper. Transmitter-receiver distance = 10 cm				
Number of sheets	1	11	27	31
Analogue output current (mA)	17.3	12	6	5

(2) Reference for both transmitter and receiver for thru-beam system.

(3) For further information, see page 162.

# Photo-electric sensors

OsiSense XU Application, material handling series

Through beam system with high "excess gain"

Solid-state output and analogue output 4...20 mA

## Dimensions

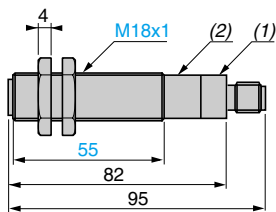

(1) LEDs  
(2) Potentiometer (only on receiver)  
Fixing nut tightening torque: 15 N.m  
Connector tightening torque: 2 N.m

## Curves

### Detection curve

#### Thru-beam system

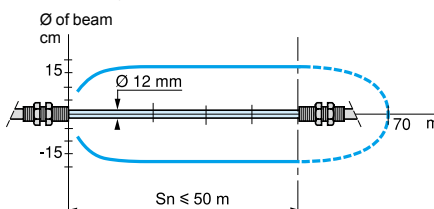

### Excess gain curve (ambient temperature: + 25 °C)

#### Thru-beam system

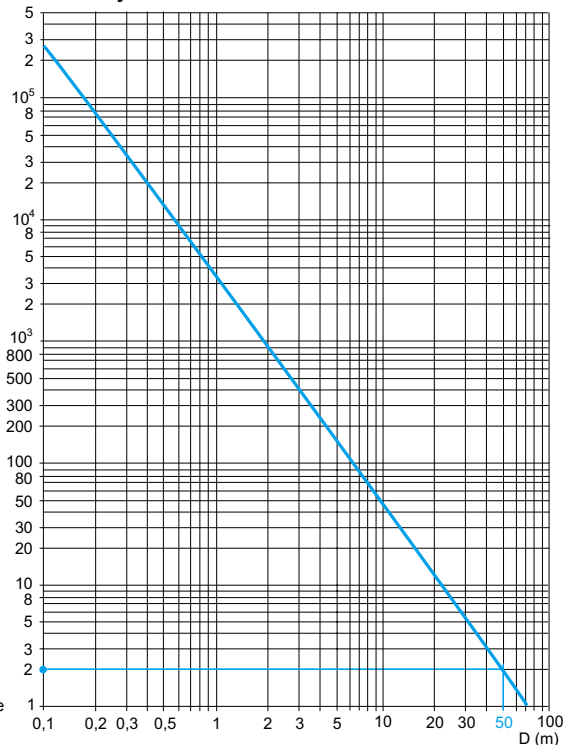

## Wiring schemes

### Receiver

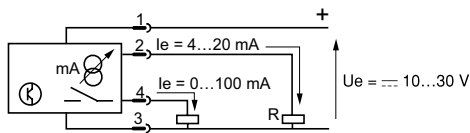

R max. < 800 Ω (Ue = 24 V), < 300 Ω (Ue = 12 V)

### Beam break test (only on transmitter)

Beam made

Beam broken

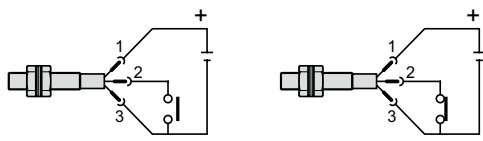

## Connector scheme

### Sensor connector pin view

#### Transmitter

#### Receiver

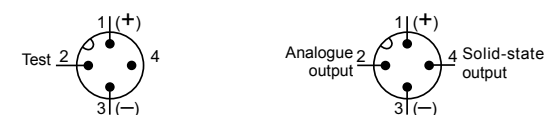

For suitable female connectors, including pre-wired versions, please refer to our catalogue "Cabling accessories OsiSense XZ".

## Operation, settings

### Type, opacity of object

### Analogue output curve

### Switching level of digital solid-state PNP output

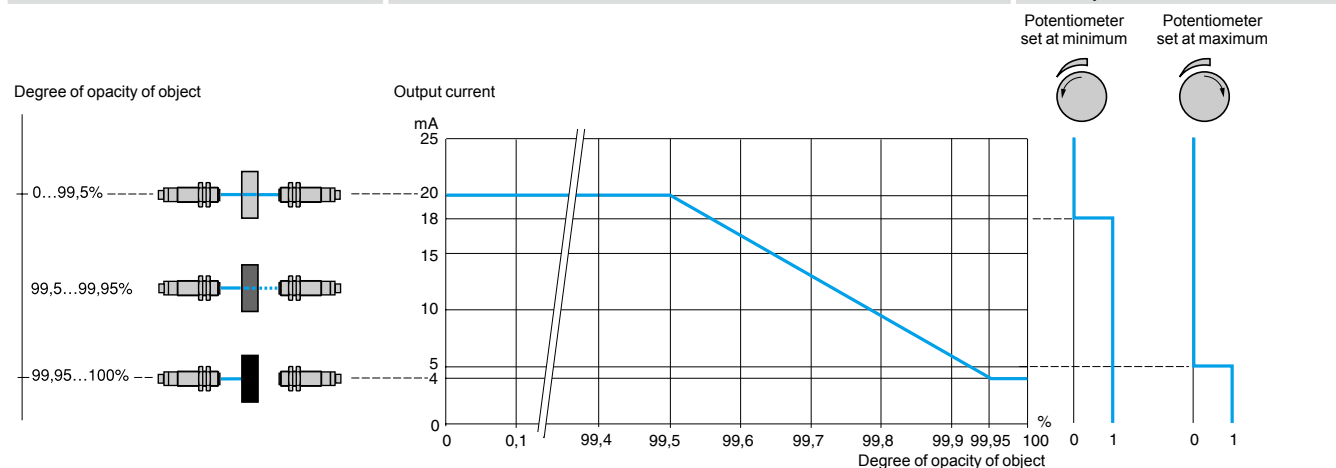

## Photo-electric sensors

OsiSense XU Application, material handling series

With analogue output signal 0...10 V or 4...20 mA  
Laser transmission

### Compact design, 50 x 50

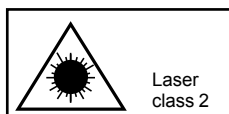

Laser class 2, conforming to IEC 825-1

Visible laser radiation: do not stare into beam.

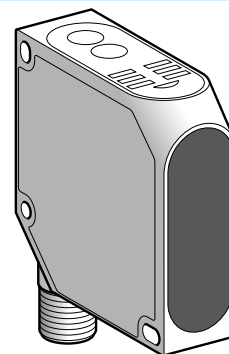
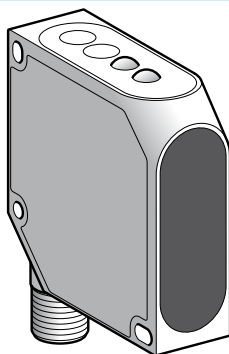

<b>System</b>		<b>Diffuse</b>		
<b>Type of transmission</b>		Red laser, pulsed, Class 2, wavelength: 670 nm		
<b>Measuring distance</b>		40...60 mm	45...85 mm	80...300 mm
<b>References</b>				
<b>3-wire, PNP output</b>		XUYPC0925L1ANSP	XUYPC0925L2ANSP	XUYPC0925L3ANSP
<b>Weight (kg)</b>		0.057	0.057	0.057
<b>Characteristics</b>				
<b>Product certifications</b>		CE		
<b>Ambient air temperature</b>	For operation	0...+45 °C		
	For storage	-20...+60 °C		
<b>Degree of protection</b>	Conforming to IEC 60529	IP 67		
<b>Resolution</b>		7 µm	20 µm	200 µm
<b>Linearity</b>		< 1%		
<b>Temperature stability</b>		10 µm/K	18 µm/K	22 µm/K
<b>Connection</b>		M12 male connector with alternative orientations		
<b>Vibration resistance</b>	Conforming to IEC 60068-2-6	7 gn, amplitude ± 1.5 mm (f = 10 to 55 Hz)		
<b>Shock resistance</b>	Conforming to IEC 60068-2-27	30 gn, duration 11 ms		
<b>Materials</b>	Case	ABS, anti-shock		
<b>Rated supply voltage</b>		⎓ 24 V with protection against reverse polarity		
<b>Voltage limits (including ripple)</b>		⎓ 18...28 V		
<b>Immunity to ambient light</b>		5000 lux		
<b>Output signal</b>		0...10 V		4...20 mA
<b>Output activation time (from 10...90%)</b>		30 ms		0.4 ms (fast speed mode) 40 ms (medium speed mode)
<b>Laser transmission</b>		T pulse: 8 µs, pulse frequency: 6 kHz, time base: 250 ms		
<b>Spot diameter</b>		< 1 mm at 50 mm	< 0.8 mm at 65 mm	1.5 x 3.5 mm at 80 mm
<b>Switching capacity</b>		3 mA with overload and short-circuit protection		
<b>Voltage drop, closed state</b>		< 2.4 V		
<b>Current consumption, no-load</b>		35 mA		≤ 40 mA on ⎓ 24 V
<b>Maximum switching frequency</b>		40 Hz		
<b>Indicator lights</b>	Dirty	Red LED		
	Supply on	Green LED		
<b>Parametering</b>		-		By buttons

■ Applications: position control of robot arm, measuring thickness of mechanical parts.

### Accessories

Description	Details	Length of cable m	References	Weight kg
<b>Pre-wired M12 connector</b>	Straight, 4-pin	2	<b>XZCP1141L2</b>	0.090
		5	<b>XZCP1141L5</b>	0.190
	Straight, 5-pin	2	<b>XZCP1164L2</b>	0.115
		5	<b>XZCP1164L5</b>	0.270
<b>Fixing bracket (1)</b>	Stainless steel 316	-	<b>XUZA51S</b>	0.050

(1) For further information, see page 168.



# Photo-electric sensors

OsiSense XU Application, material handling series

With analogue output signal 0...10 V or 4...20 mA  
Laser transmission

## Presentation

XUYPCO925L1ANSP, XUYPCO925L2ANSP

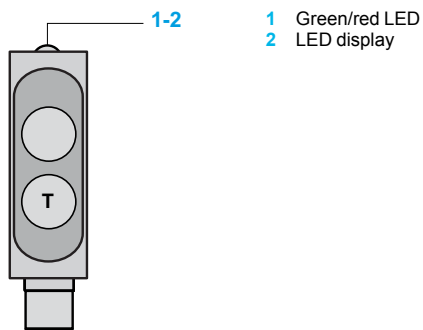

R: Receiver  
T: Transmitter

XUYPCO925L3ANSP

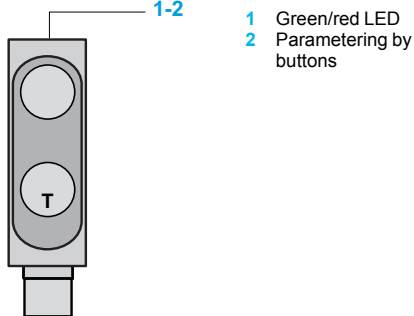

Application example

Monitoring dimensions in series

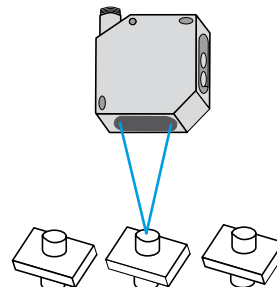

## Dimensions

XUYPCO925L1ANSP, XUYPCO925L2ANSP

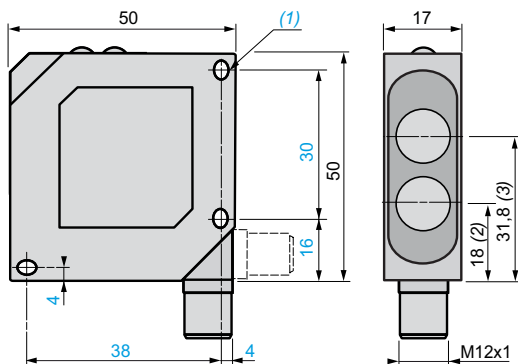

XUYPCO925L3ANSP

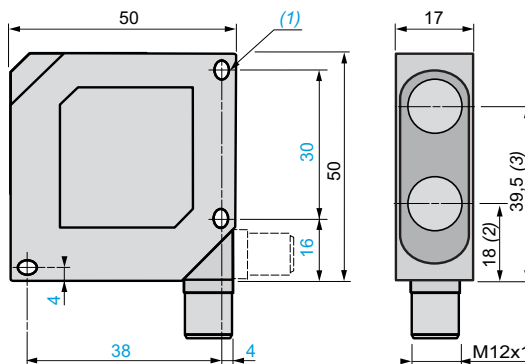

(1) 2 elongated holes  $\varnothing 4.3 \times 4$ .  
(2) Transmitter optical axis.  
(3) Receiver optical axis.

## Wiring schemes

XUYPCO925L1ANSP, XUYPCO925L2ANSP

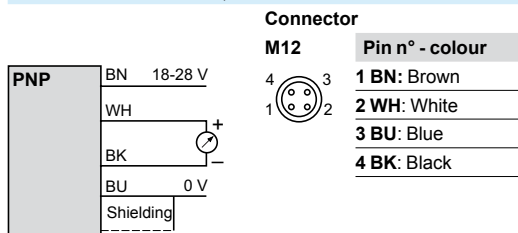

XUYPCO925L3ANSP

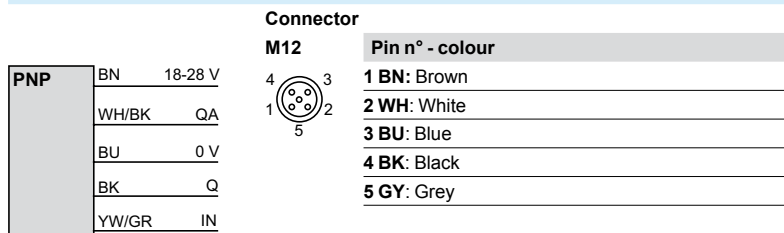

Note: Shielded cable recommended.

QA: 4-20 mA analogue output ( $R \leq 500 \Omega$ )  
Q: Switching output  
IN: Control input (YW/GR: Yellow/green)

## Adjustment curves

XUYPCO925L1ANSP, XUYPCO925L2ANSP

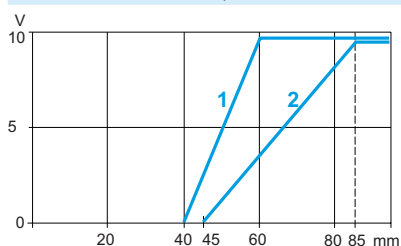

1 XUYPCO925L1ANSP  
2 XUYPCO925L2ANSP

XUYPCO925L3ANSP

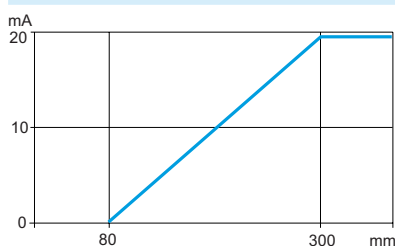

## Photo-electric sensors

OsiSense XU Application, material handling series

Diffuse, with laser transmission

With background suppression

DC supply. Solid-state output

### Compact design

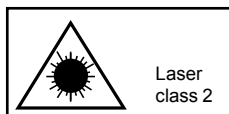

Laser class 2, conforming to IEC 60825-1

Visible laser radiation: do not stare into beam.

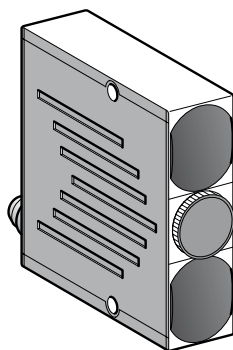

<b>System</b>	<b>Diffuse with background suppression</b>	
<b>Type of transmission</b>	<b>Red laser, pulsed, Class 2, wavelength: 675 nm</b>	
<b>Detection distance</b>	<b>Adjustable from 50 to 300 mm</b>	
<b>Minimum size of object</b>	<b>0.5 mm</b>	
<b>References</b>		
<b>4-wire, PNP and NPN output</b>	NO/NC depending on wiring	<b>XUYPS1LCO965S</b>
<b>Weight (kg)</b>	0.081	
<b>Characteristics</b>		
<b>Product certifications</b>	CE, cULus (1)	
<b>Ambient air temperature</b>	For operation	0...+ 50 °C
	For storage	- 20...+ 80 °C
<b>Degree of protection</b>	Conforming to IEC 60529	IP 65
<b>Connection</b>	M8, 4-pin male connector (for pre-cabled version please consult our Customer Care Centre)	
<b>Materials</b>	Case	Glass impregnated nylon
	Lens	PMMA
<b>Rated supply voltage</b>	⎓ <b>12...24 V with protection against reverse polarity</b>	
<b>Voltage limits (including ripple)</b>	⎓ <b>10...30 V</b>	
<b>Immunity to ambient light</b>	Incandescent bulb	500 lux
	Natural light	10 000 lux
<b>Laser transmission</b>	Pulsed laser LED	T pulse: 6 µs, T period < 50 µs
<b>Spot size</b>	Manual adjustment of focusing	
<b>Switching capacity</b>	<b>100 mA with overload and short-circuit protection</b>	
<b>Voltage drop, closed state</b>	< 2 V	
<b>Current consumption, no-load</b>	35 mA	
<b>Maximum switching frequency</b>	<b>5 kHz</b>	
<b>Delays</b>	Response and recovery	< 150 µs
<b>Indicator lights</b>	Time delay active	Red indicator
	Output state	Green indicator
	NO function	Red indicator
	NC function	Indicator off
<b>Output signal time delay</b>	40 ms, depending on wiring	

(1) This product is UL Listed if supplied by a class II or isolated supply delivering ⎓ 30 V max. (isolated transformer for example) and protected by a UL fuse rated at 3 A max.

**Applications:** monitoring of small parts on production machine, detection of components on a printed circuit, monitoring for crack on a component, control of level, suppression of a background.

### Accessories

Description	Details	Length of cable	References	Weight
		m		kg
<b>Pre-wired M8 connector</b>	Straight	2	<b>XZCP0941L2</b>	0.080
	Elbowed (90°)	2	<b>XZCP1041L2</b>	0.080
	Straight	5	<b>XZCP0941L5</b>	0.180
	Elbowed (90°)	5	<b>XZCP1041L5</b>	0.180

# Photo-electric sensors

OsiSense XU Application, material handling series

Diffuse, with laser transmission

With background suppression

DC supply. Solid-state output

## Presentation

XUYPS1LCO965S

Rear view

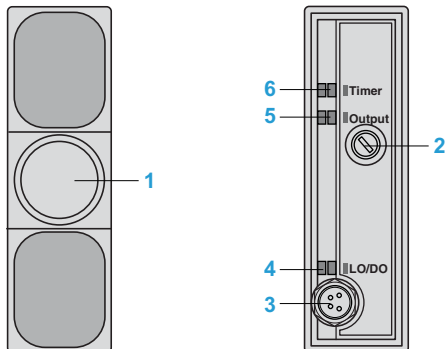

- 1 Adjustment of spot size
- 2 Detection distance adjustment screw
- 3 M8 connector
- 4 On: NO function  
Off: NC function
- 5 Object detected
- 6 Time delay active

## Dimensions

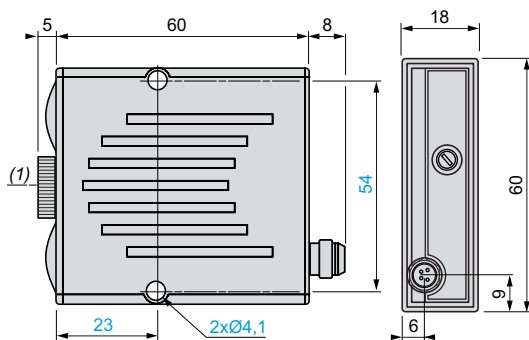

(1) Optical axis of laser

## Wiring schemes

### NO function

Without time delay

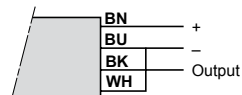

With 40 ms time delay

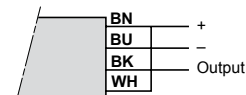

### NC function

Without time delay

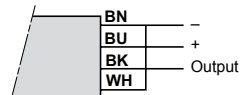

With 40 ms time delay

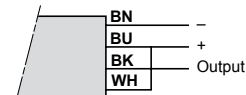

### M8 connector



#### Pin n° - colour

- 1 BN: Brown
- 2 WH: White
- 3 BU: Blue
- 4 BK: Black

## Application examples

Monitoring for crack in a component

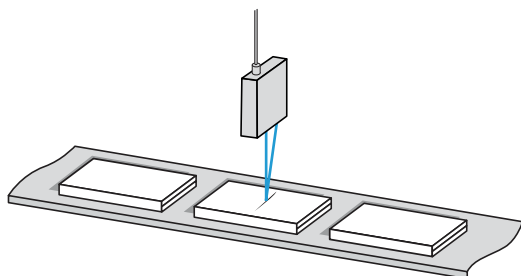

Monitoring for a broken punch on press tool

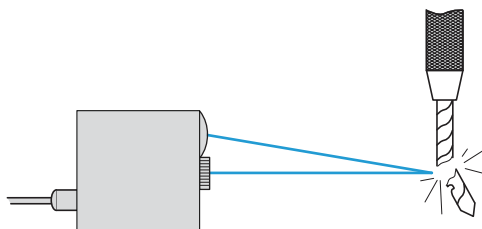

## Photo-electric sensors

OsiSense XU Application, material handling series  
Diffuse, with 2 channels using triangulation  
with background suppression  
DC supply. Solid-state output

### Compact design

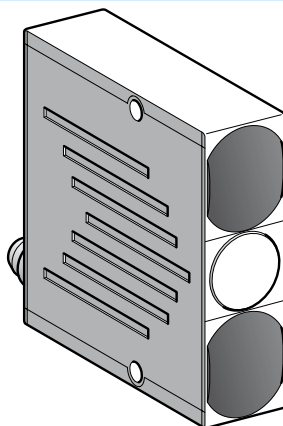

<b>System</b>	<b>Diffuse with background suppression</b>		
<b>Type of transmission</b>	Infrared LED, modulated, Ø 15 mm beam		
<b>Detection distance</b>	Adjustable from 50 to 600 mm		
<b>References</b>			
<b>4-wire, PNP and NPN output</b>	NO/NC programmable function	<b>XUYPS2945S</b>	<b>XUYPS2C0945S</b>
<b>Weight (kg)</b>		0.135	0.055
<b>Characteristics</b>			
<b>Product certifications</b>	CE, cULus (1)		
<b>Ambient air temperature</b>	For operation	0...+50 °C	
	For storage	-20...+80 °C	
<b>Degree of protection</b>	Conforming to IEC 60529	IP 65	
<b>Connection</b>		Pre-cabled, length 2 m	M8, 4-pin male connector
<b>Materials</b>	Case	Glass impregnated nylon	
<b>Rated supply voltage</b>	⎓ 12...24 V with protection against reverse polarity		
<b>Voltage limits</b> (including ripple)	⎓ 10...30 V		
<b>Immunity to ambient light</b>	Incandescent bulb	1300 lux	
	Natural light	10 000 lux	
<b>Switching capacity</b>	<b>100 mA with overload and short-circuit protection</b>		
<b>Voltage drop, closed state</b>	< 2 V		
<b>Current consumption, no-load</b>	< 1.5 W		
<b>Maximum switching frequency</b>	<b>370 Hz</b>		
<b>Delay</b>	Response and recovery	< 1.8 ms	
<b>Output signal time delay</b>	For A and B/A or B (2)	Determined by wiring	
<b>Indicator light</b>	Output signal	Green LED	

(1) This product is UL Listed if supplied by a class II or isolated supply delivering ⎓ 30 V max. (isolated transformer for example) and protected by a UL fuse rated at 3 A max.

(2) See next page

■ Applications:

- Control of filling, detection of object on conveyor against reflective background.

### Accessories

Description	Details	Length of cable	References	Weight
		m		kg
<b>Pre-wired M8 connector</b>	Straight	2	<b>XZCP0941L2</b>	0.080
	Elbowed (90°)	2	<b>XZCP1041L2</b>	0.080
	Straight	5	<b>XZCP0941L5</b>	0.180
	Elbowed (90°)	5	<b>XZCP1041L5</b>	0.180

# Photo-electric sensors

OsiSense XU Application, material handling series  
Diffuse, with 2 channels using triangulation  
with background suppression  
DC supply. Solid-state output

## Presentation

XUYPS2945S, XUYPS2CO945S

### Rear view

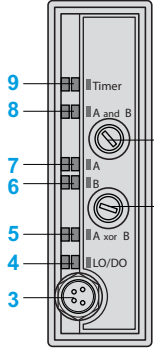

- 1 Adjustment of zone A detection distance
- 2 Adjustment of zone B detection distance
- 3 Pre-cabled connection (XUYPS2945S) or M8 connector (XUYPS2CO945S)
- 4 On in direct mode  
Illuminates when the "exclusive OR" function between the two zones A and B is obtained
- 5 On when the object is present in zone B
- 6 On when the object is present in zone A
- 7 Illuminates when the "AND" object logic function between the two zones A and B is obtained
- 8 Indicates time delay mode  
Simultaneously on when the "OR" logic function between the 2 zones A or B is obtained
- 9 the two zones A and B is obtained

## Description (4 operating modes)

### Two independent sensors with triangulation: A, B

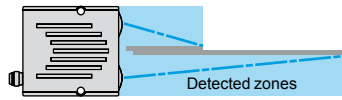

### Immunity to reflection: A and B

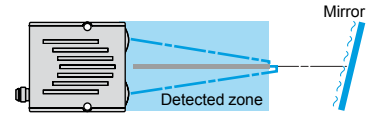

### Detection of contrasting objects: A or B

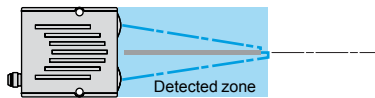

### Monitoring of distance: A xor B

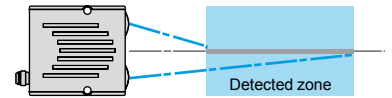

## Dimensions

XUYPS2945S, XUYPS2CO945S

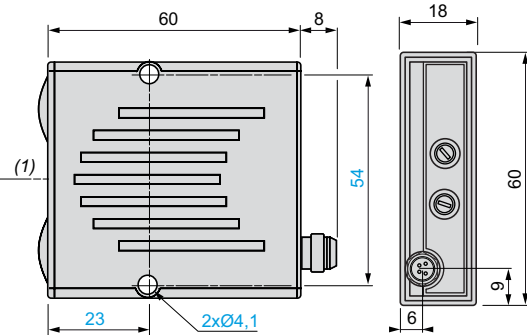

## Detection curves (typical)

XUYPS2945S, XUYPS2CO945S

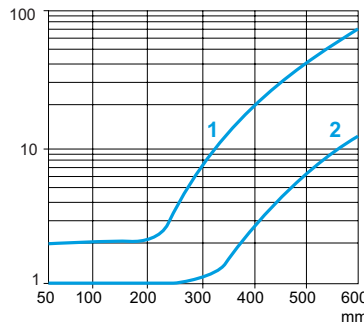

- 1 Black 6%
- 2 Grey 18% - Distance (mm) set on 92% (Kodak 1527795)

(1) Optical axis.

## Wiring schemes and outputs

### Two independent sensors with triangulation: A, B

#### NO output

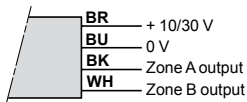

#### NC output

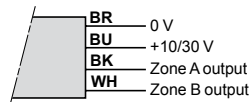

### Immunity to reflection: A and B

#### Without time delay

#### NO output

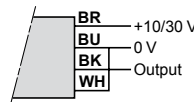

#### NC output

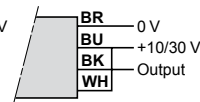

#### With 40 ms time delay

#### NO output

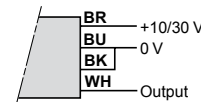

#### NC output

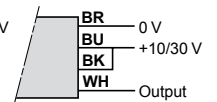

### Detection of contrasting objects: A or B

#### NO output

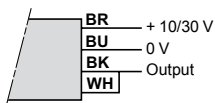

#### NC output

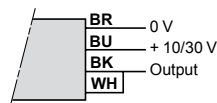

### Monitoring of distance: A xor B

#### Without time delay

#### NO output

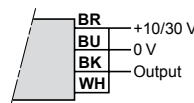

#### NC output

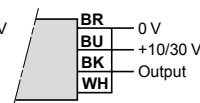

#### With 40 ms time delay

#### NO output

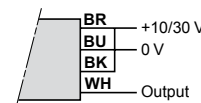

#### NC output

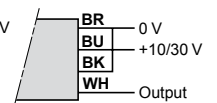

BR: Brown  
BU: Blue  
BK: Black  
WH: White

# Photo-electric sensors

OsiSense XU Application

Fibre design, amplifiers

Three-wire DC, solid-state output

Teach mode

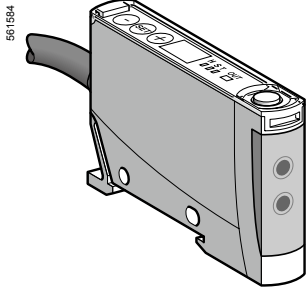

XUDA2

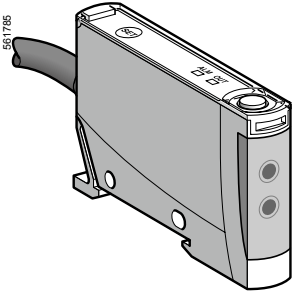

XUDA1

### Amplifiers with fine adjustment and 4-digit screen

Sensing distance (Sn) m	Function	Output	Connection	Reference	Weight kg
Depending on fibre	NO/NC Programmable	PNP	Pre-cabled	<b>XUDA2PSML2</b>	0.040
			M8 connector	<b>XUDA2PSMM8</b>	0.040
		NPN	Pre-cabled	<b>XUDA2NSML2</b>	0.040
			M8 connector	<b>XUDA2NSMM8</b>	0.040

### Amplifiers using teach mode

Sensing distance (Sn) m	Function	Output	Connection	Reference	Weight kg
Depending on fibre	NO/NC Programmable	PNP	Pre-cabled	<b>XUDA1PSML2</b>	0.040
			M8 connector	<b>XUDA1PSMM8</b>	0.040
		NPN	Pre-cabled	<b>XUDA1NSML2</b>	0.040
			M8 connector	<b>XUDA1NSMM8</b>	0.040

Characteristics		XUDA1●●SMM8, XUDA2●●SMM8	XUDA1●●SML2, XUDA2●●SML2
Sensor type			
Product certifications		CE, cULus	
Connection	Connector	M8	–
	Pre-cabled	–	Length: 2 m
Sensing distance (Sn)		Depending on fibre used, see page 134. Sensing distance halved for XUDA2 configured for fast frequency	
Sensitivity adjustment		Teach mode on XUDA1, Teach mode and fine adjustment (+/- button) plus 4-digit screen on XUDA2	
Type of transmission		Red	
Degree of protection	Conforming to IEC 60529	IP 65 with Ø 2 mm fibre (IP 64 with Ø 1 mm fibre)	
Storage temperature		°C - 30...+ 70	
Operating temperature		°C - 10...+ 55	
Vibration resistance	Conforming to IEC 60068-2-6	7 gn, amplitude ± 0.5 mm (f = 10 to 55 Hz)	
Shock resistance	Conforming to IEC 60068-2-27	30 gn, duration 11 ms	
Indicator lights	Output state	Yellow LED	
	Stability	Red LED for XUDA1	
	Stability	Green LED for XUDA2	
Signal level		By 7 segment/4-digit display for XUDA2	
Rated supply voltage		V --- 12...24 with protection against reverse polarity	
Voltage limits (including ripple)		V --- 10.8...26.4	
Current consumption, no-load		mA ≤ 50	
Switching capacity		mA ≤ 100 with overload and short-circuit protection	
Alarm output		mA ≤ 50 for XUDA2 with overload and short-circuit protection	
Protection against mutual interference		Yes for XUDA2	
Voltage drop, closed state		V ≤ 2 for XUDA●P●●●●, ≤ 1 for XUDA●N●●●●●	
Maximum switching frequency		kHz 1 kHz for XUDA1, 1 or 5 kHz configurable for XUDA2	
Output time delay		ms 0 or 40 on recovery for XUDA2	
Delays	First-up	ms < 120	
	Response	ms < 0.5 (0.1 for XUDA2 in fast frequency mode)	
	Recovery	ms < 0.5 (0.1 for XUDA2 in fast frequency mode)	

### XUDA2 wiring schemes

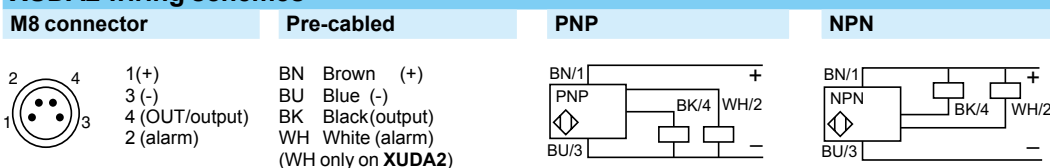

### XUDA1 wiring schemes

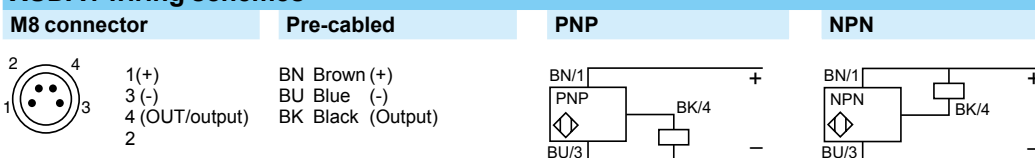

Please refer to our "Cabling accessories OsiSense XZ" catalogue.

### Dimensions

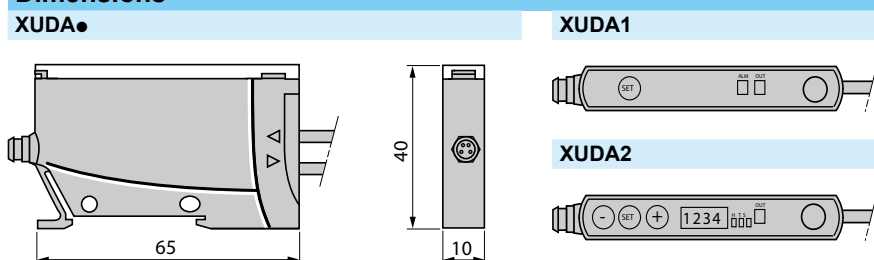

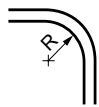

R = minimum bend radius  
Fibre of ext. Ø 2.2 mm, R = 25 mm  
Fibre of ext. Ø 1 mm, R = 10 mm  
XUFN2S01L, R = 4 mm

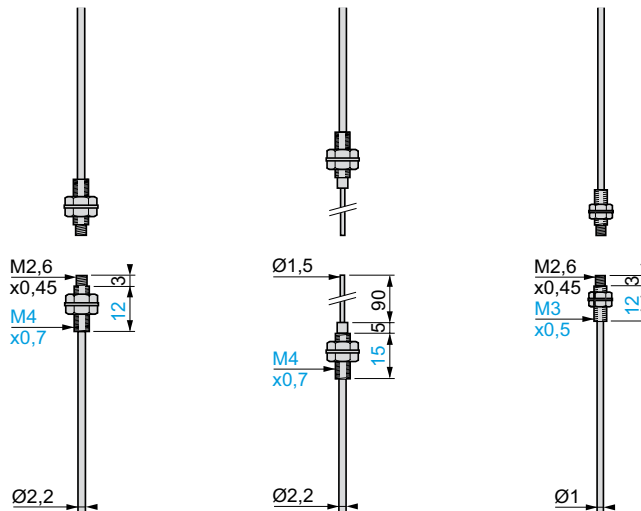

Nominal sensing distance (Sn)	With fibre L = 2 m	200 mm (1)	180 mm	50 mm (1)
	With lens	1500 mm (2)	–	1000 mm (2)
Application, features		General purpose		Accurate positioning

### References (complete assembly - 2 fibres)

With standard end fittings	L = 2 m	XUFN12301	–	XUFN35301
	L = 10 m	XUFN12301L10	–	–
With 90 mm flexible end fittings, L = 2 m		–	XUFN12311	–
Weight (kg)		0.058 (L = 2 m)	0.030	0.045

### Characteristics

Fibre (view on sensing face)			
Core (Ø mm)	1 x Ø 1	1 x Ø 1	1 x Ø 0.5
Trimable to required length (trimmer XUFZ11 included)	Yes	Yes	Yes
Ambient air temperature	For operation: - 25... + 60 °C. For storage: - 40... + 80 °C		
Vibration resistance	7 gn, amplitude ± 1.5 mm (f = 10...55 Hz), conforming to IEC 60068-2-6		
Shock resistance	30 gn, duration 11 ms, conforming to IEC 60068-2-27		
Degree of protection	IP 64 conforming to IEC 60529 and IP 641 conforming to NF C 20-010		
Materials	Fibres: PMMA; sheath: PE		

### Detection curves

XUFN●●●●L10	XUFN12301, XUFN12311	XUFN35301
Percentage reduction in sensing distance related to length of fibre		

(1) Can be used with 90° mirror XUFZ02, see page 140.  
(2) With lens accessory XUFZ01, see page 140.



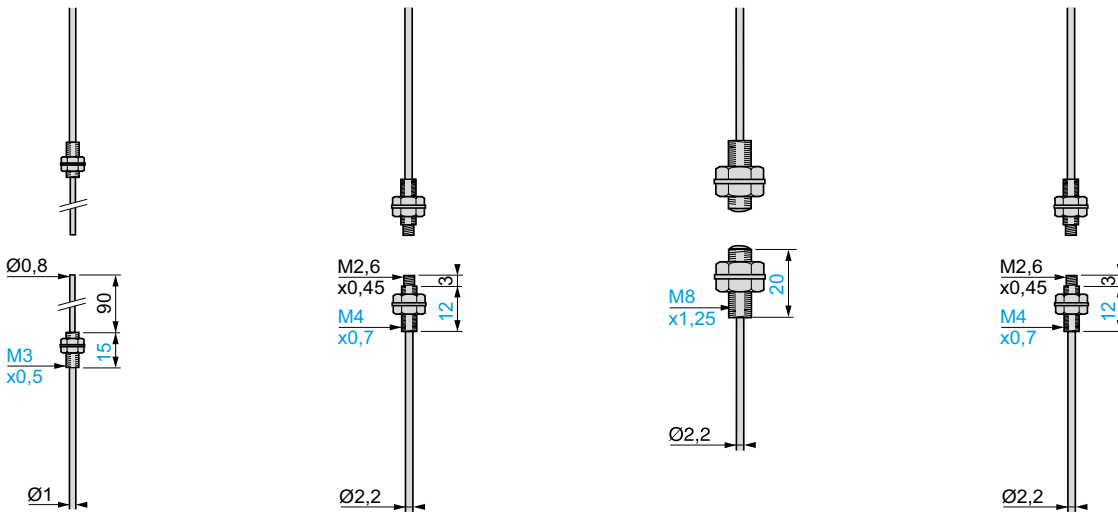

30 mm	300 mm (1) 2000 mm (2)	2500 mm	100 mm (1) 750 mm (2)
-	-	-	-
Accurate positioning	Long sensing distance fibres	Fibres with integral lens Resistant to accumulation of dirt	Flexible fibres for cyclic movements, areas with restricted access
-	<b>XUFN2P01L2</b>	<b>XUFN2L01L2</b>	<b>XUFN2S01L2</b>
-	<b>XUFN2P01L10</b>	<b>XUFN2L01L10</b>	<b>XUFN2S01L10</b>
<b>XUFN35311</b>	-	-	-
0.045	0.058 (L = 2 m)	0.060 (L = 2 m)	0.062 (L = 2 m)
○	○	●	●
1 x $\varnothing 0.5$	1 x $\varnothing 1.5$	1 x $\varnothing 1$	1 x $\varnothing 1$
Yes	Yes	Yes	Yes

For operation: - 25...+ 60 °C. For storage: - 40...+ 80 °C

7 gn, amplitude  $\pm 1.5$  mm (f = 10...55 Hz), conforming to IEC 60068-2-6

30 gn, duration 11 ms, conforming to IEC 60068-2-27

IP 64 conforming to IEC 60529 and IP 641 conforming to NF C 20-010

Fibres: PMMA; sheath: PE

XUFN35311

XUFN2P01L2

XUFN2L01L2

XUFN2S01L2

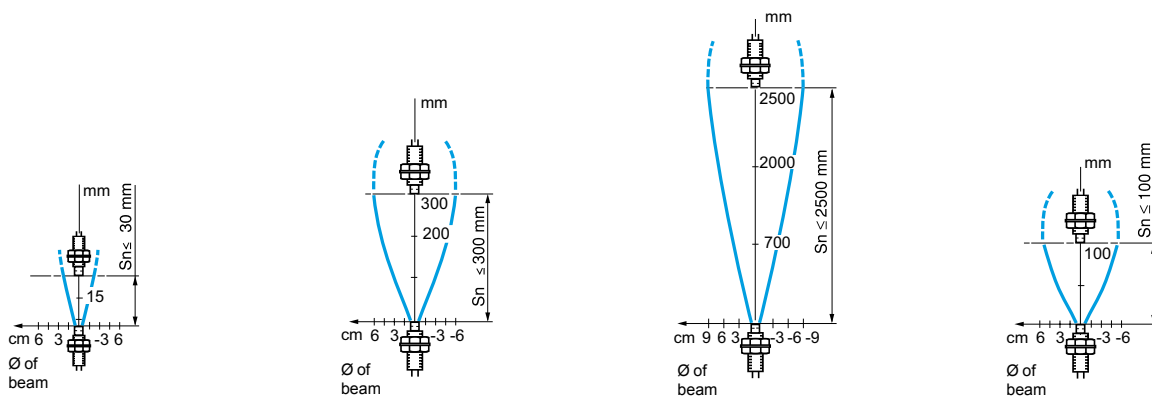

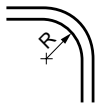

R = minimum bend radius  
Fibre of ext. Ø 2.2 mm, R = 25 mm  
Fibre of ext. Ø 1 mm, R = 10 mm  
XUFN5S01L, R = 4 mm

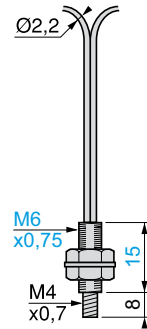
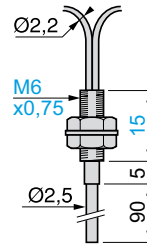
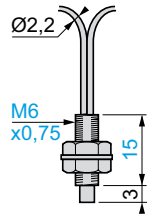

Nominal sensing distance (Sn)	70 mm	60 mm	60 mm
Application, features	General purpose		Positioning

References			
With standard end fittings	L = 2 m	XUFN05321	XUFN05323
	L = 10 m	XUFN05321L10	-
With 90 mm flexible end fittings, L = 2 m		-	XUFN05331
Weight (kg)		0.058 (L = 2 m)	0.030

Characteristics			
Fibre (view on sensing face)			
Core (Ø mm)	2 x Ø 1	2 x Ø 1	1 x Ø 1 + 16 x Ø 0.265
Trimmable to required length (trimmer XUFZ11 included)	Yes	Yes	Yes
Ambient air temperature	For operation: - 25... + 60 °C. For storage: - 40... + 80 °C		
Vibration resistance	7 gn, amplitude ± 1.5 mm (f = 10...55 Hz), conforming to IEC 60068-2-27		
Shock resistance	30 gn, duration 11 ms, conforming to IEC 60068-2-27		
Degree of protection	IP 64 conforming to IEC 60529 and IP 641 conforming to NF C 20-010		
Materials	Fibres: PMMA; sheath: PE		

**Detection curves (object 10 x 10 cm, white 90%)**

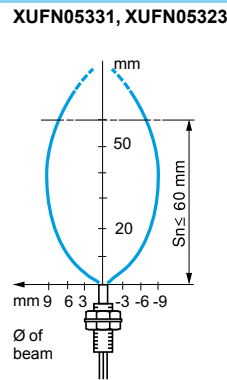
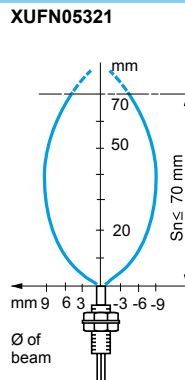
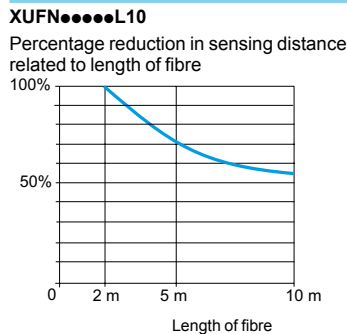

(1) Fixing clamps included with fibre optic.

# Photo-electric sensors

OsiSense XU Application

Fibre optics for amplifiers

“PLASTIC” fibres with end fittings, diffuse system

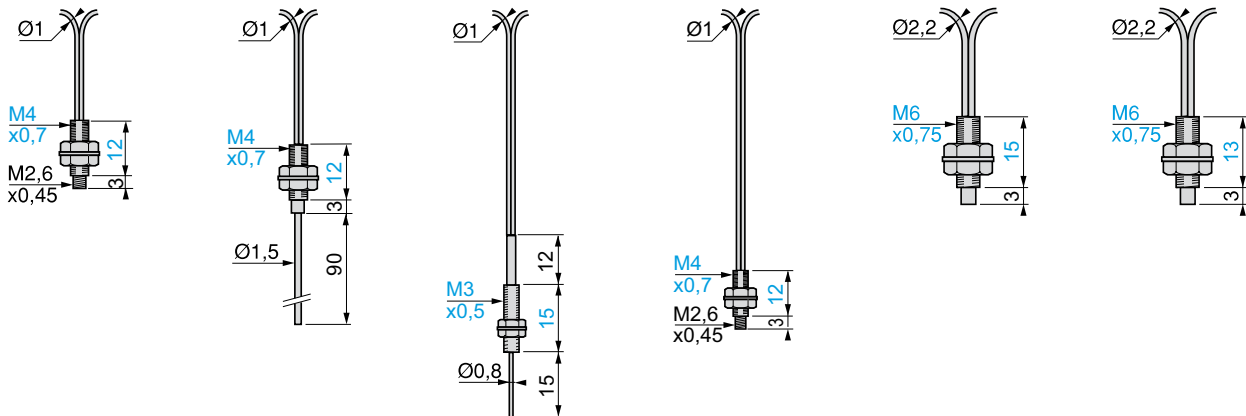

18 mm	18 mm	6 mm	15 mm	95 mm	55 mm
Positioning	Positioning	Areas with restricted access	Positioning	Long sensing distance fibres	Flexible fibres for cyclic movements, areas with restricted access
<b>XUFN01321</b>	–	<b>XUFN04331</b>	<b>XUFN02323</b>	<b>XUFN5P01L2</b>	<b>XUFN5S01L2</b>
–	–	–	–	<b>XUFN5P01L10</b>	<b>XUFN5S01L10</b>
–	<b>XUFN01331</b>	–	–	–	–
0.045	0.045	0.045	0.040	0.058 (L = 2 m)	0.062 (L = 2 m)
●	●	●	●●●	●●	●●
2 x Ø 0.5	2 x Ø 0.5	2 x Ø 0.265	1 x Ø 0.5 + 4 x Ø 0.25	2 x Ø 1.5	2 x Ø 1
Yes	Yes	Yes	Yes	Yes	Yes
For operation: - 25...+ 60 °C. For storage: - 40...+ 80 °C					
7 gn, amplitude ± 1.5 mm (f = 10...55 Hz), conforming to IEC 60068-2-27		7 gn, amplitude ± 1.5 mm (f = 10...55 Hz), conforming to IEC 60068-2-6			
30 gn, duration 11 ms, conforming to IEC 60068-2-27					
IP 64 conforming to IEC 60529 and IP 641 conforming to NF C 20-010					
Fibres: PMMA; sheath: PE					

**XUFN01321, XUFN01331**

**XUFN04331**

**XUFN02323**

**XUFN5P01L2**

**XUFN5S01L2**

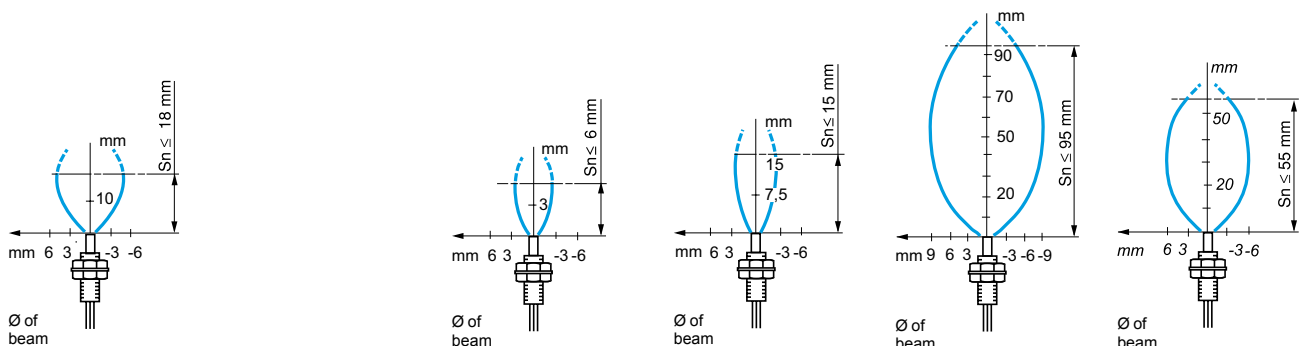

# Photo-electric sensors

OsiSense XU Application

Fibre optics for amplifiers

“GLASS” fibres with end fittings, thru-beam and diffuse systems

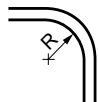

R = minimum bend radius  
Metal sheath, R = 90 mm

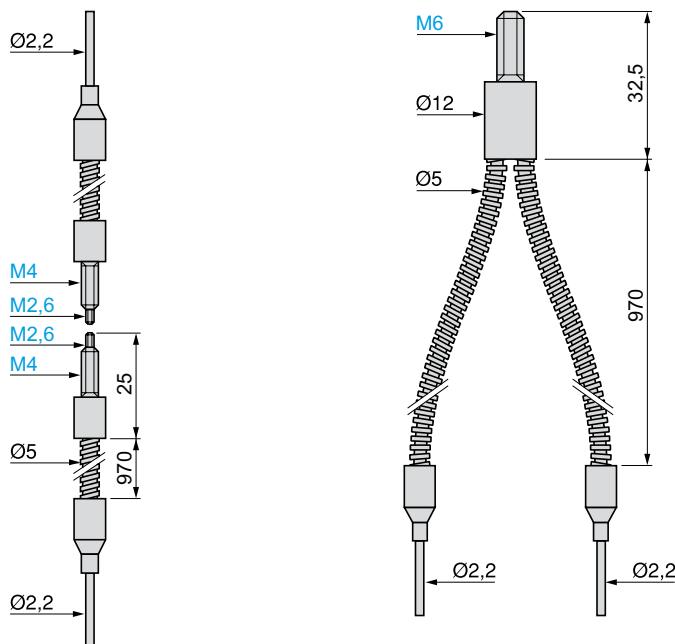

System	Thru-beam	Diffuse
Nominal sensing distance (Sn) with fibre L = 1 m	200 mm (1) 1500 mm (2)	70 mm
Application	High temperatures	

## References (complete assembly - 2 fibres for thru-beam system)

With standard end fittings	L = 1 m	XUFS2020	XUFS0520
Weight (kg)		0.070	0.075

## Characteristics

Fibre (view on sensing face)		
Core (Ø mm)	1 x Ø 1	2 x Ø 1
Ambient air temperature	For operation and storage: - 40...+ 180 °C	
Vibration resistance	7 gn, amplitude ± 1.5 mm (f = 10...55 Hz), conforming to IEC 60068-2-6	
Shock resistance	30 gn, duration 11 ms, conforming to IEC 60068-2-27	
Degree of protection	IP 64 conforming to IEC 60529 and IP 641 conforming to NF C 20-010	
Materials	Fibres: glass; sheath: metal	

## Detection curves

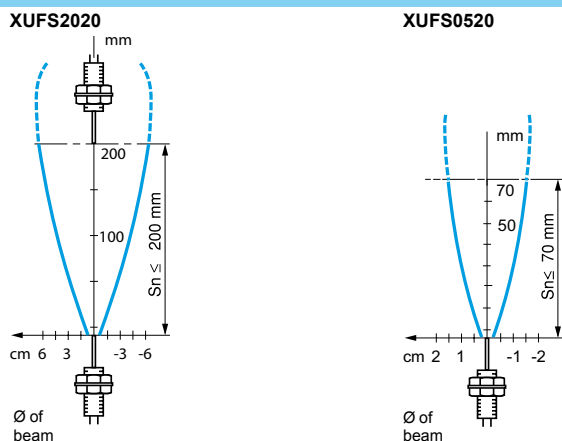

(1) Can be used with 90° mirror **XUFZ02**, see page 140.  
(2) With lens accessory **XUFZ01**, see page 140.

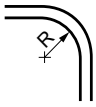

R = minimum bend radius  
Fibre of ext. Ø 2.2 mm, R = 25 mm

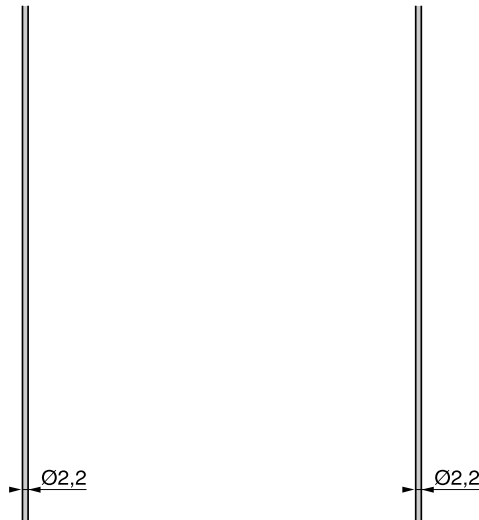

Nominal sensing distance (Sn) L = 2 m	See detection curves below (1)			
Application	General purpose			
<b>References</b>				
Fibre without end fitting	<b>XUFZ910</b>	<b>XUFZ920</b>	<b>XUFZ911</b>	<b>XUFZ921</b>
Weight (kg)	0.020	0.040	0.040	0.080
<b>Characteristics</b>				
Fibre				
Core (Ø mm)	1 x Ø 1		1 x Ø 1.4	
Length	10 m	20 m	10 m	20 m
Trimmable to required length (trimmer XUFZ11 included)	Yes		Yes	
Ambient air temperature	For operation: - 25...+ 60 °C. For storage: - 40...+ 80 °C			
Vibration resistance	7 gn, amplitude ± 1.5 mm (f = 10...55 Hz), conforming to IEC 60068-2-6			
Shock resistance	30 gn, duration 11 ms, conforming to IEC 60068-2-27			
Degree of protection	IP 64 conforming to IEC 60529 and IP 641 conforming to NF C 20-010			
Materials	Fibres: PMMA; sheath: PE			

### Detection curves

XUFZ911, XUFZ921  
XUFZ910, XUFZ920

XUFZ910, XUFZ920

XUFZ911, XUFZ921

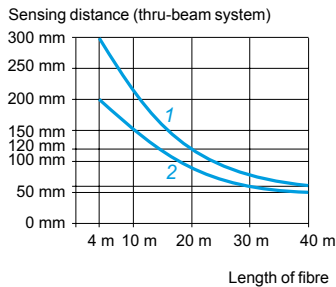

1 XUFZ911, XUFZ921

2 XUFZ910, XUFZ920

Total length = sum of the 2 strands used to constitute a thru-beam system

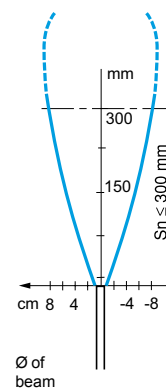
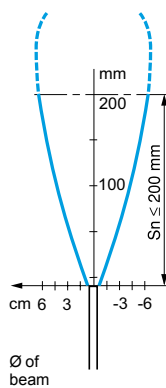

(1) It is possible to increase the sensing distance of fibres without end fittings by using fixing clamps with lens (XUFZ03, XUFZ04 or XUFZ05), see page 140).

# Photo-electric sensors

## OsiSense XU Application

### Fibre optics for amplifiers

#### Accessories



XUFZ02



XUFZ01

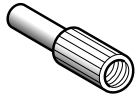

XUFZ06

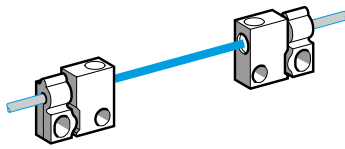

XUFZ13, XUFZ03

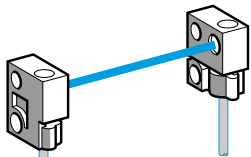

XUFZ14, XUFZ04

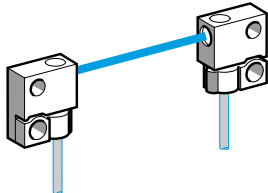

XUFZ15, XUFZ05

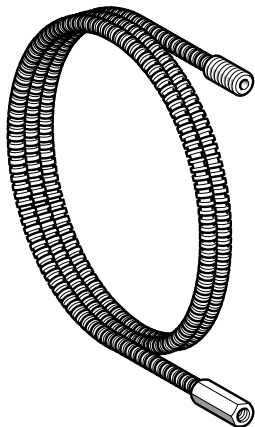

XUFZ10

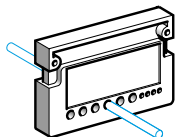

XUFZ11

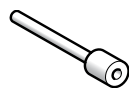

XUFZ08

#### Accessories for fibres with threaded end fittings

Description	For use with	Reference	Weight kg
<b>90° mirror</b> (set of 2)	Fibre optics XUFN1●30●, XUFN35301 and XUFS2020 (thru-beam system) XUFN2●01L●●	<b>XUFZ02</b>	0.005
<b>Lenses for increasing sensing distance</b> (set of 2)	Fibre optics XUFN1●30●, XUFN35301 and XUFS2020 (thru-beam system)	<b>XUFZ01</b>	0.005
<b>Focusing lens</b> for high precision detection. Detection of 0.5 mm objects at a distance of 7 mm. Also enables detection of objects against a background (1)	Fibre optics XUFN02323 (diffuse system)	<b>XUFZ06</b>	0.001

#### Accessories for plastic fibres without end fittings

Description	Mounting plane	For use with	Reference	Weight kg
<b>Fixing clamps</b> (set of 2)	Axial	Plastic fibre optics XUFZ	<b>XUFZ13</b>	0.002
	Frontal	Plastic fibre optics XUFZ	<b>XUFZ14</b>	0.002
	Lateral	Plastic fibre optics XUFZ	<b>XUFZ15</b>	0.002
<b>Fixing clamps with lens</b> (set of 2)	Axial	Plastic fibre optics XUFZ	<b>XUFZ03</b>	0.002
	Frontal	Plastic fibre optics XUFZ	<b>XUFZ04</b>	0.002
	Lateral	Plastic fibre optics XUFZ	<b>XUFZ05</b>	0.002

#### Protection accessories

Description	For use with	Reference	Weight kg
<b>Protective tubing</b> Length 1 m	Plastic fibre optic light guides with M4 threaded end fittings	<b>XUFZ210</b>	0.040
	Plastic fibre optic light guides with M6 threaded end fittings	<b>XUFZ310</b>	0.065

#### Other accessories

Description	Sold in lots of	Unit reference	Weight kg
<b>Fibre trimmer</b>	1	<b>XUFZ11</b>	0.006
<b>Plastic end adaptor</b> , for connecting Ø 1 mm fibres to amplifiers XUDA	2	<b>XUFZ08</b>	0.002

(1) Characteristics obtained when the fibre is fully screwed into the lens (screwing depth = 4 mm).

**Detection curves for plastic fibre optic light guides with fixing clamps**

Sensing distance of fibres XUFZ9●●● fitted with fixing clamps XUFZ●●

Fibre type	Clamp type				
	XUFZ13	XUFZ14, Z15	XUFZ03	XUFZ04, XUFZ05	Without clamp
XUFZ910, XUFZ920 (2 fibres L = 2 m) Sn	150 mm	100 mm	800 mm	600 mm	200 mm
XUFZ911, XUFZ921 (2 fibres L = 2 m) Sn	220 mm	150 mm	1200 mm	900 mm	300 mm

Other fibre lengths:

5 m fibres: reduce the sensing distance by a factor of 0.7.

10 m fibres: reduce the sensing distance by a factor of 0.5.

20 m fibres: reduce the sensing distance by a factor of 0.3.

**Detection curves with lens**

Fixing clamp XUFZ03, Z04 or Z05 + fibre XUFZ910 or XUFZ920

Fixing clamp XUFZ03, Z04 or Z05 + fibre XUFZ911 or XUFZ921

**Detection curves without lens**

Fixing clamp XUFZ13, Z14 or Z15 + fibre XUFZ910 or XUFZ920

Fixing clamp XUFZ13, Z14 or Z15 + fibre XUFZ911 or XUFZ921

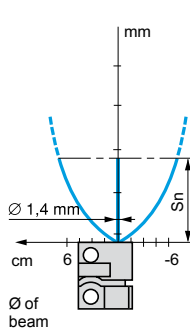
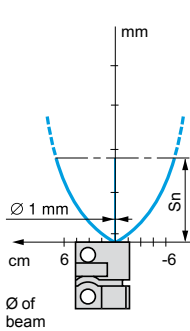
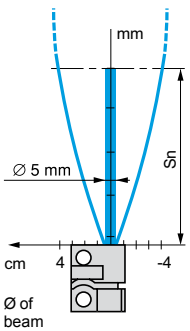
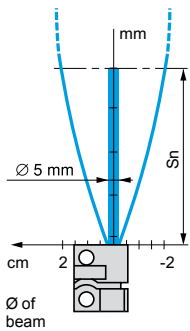

**Dimensions**

**XUFZ01**

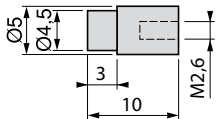

**XUFZ210**

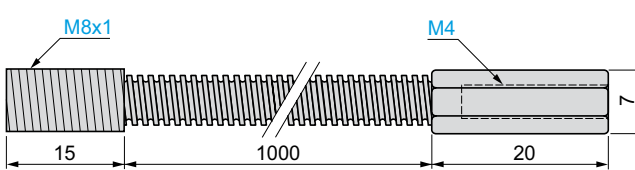

**XUFZ06**

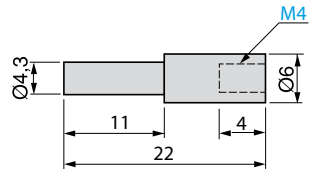

**XUFZ02**

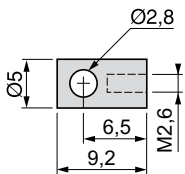

**XUFZ310**

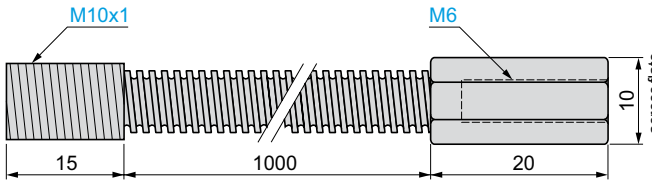

**XUFZ03, XUFZ13**

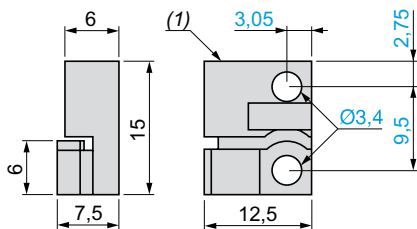

**XUFZ04, XUFZ14**

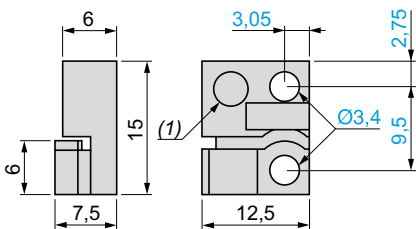

**XUFZ05, XUFZ15**

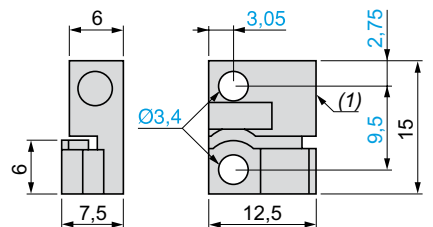
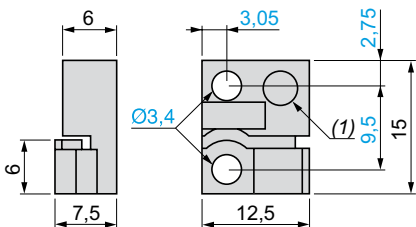
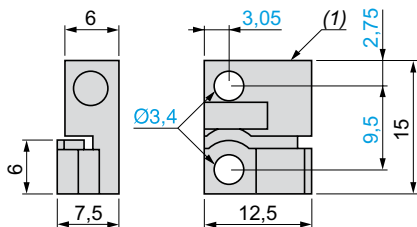
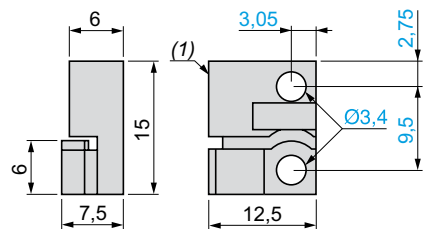

(1) Light beam window.

**“GLASS” fibre optics for diffuse system**

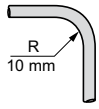

**Standard sheath**  
External Ø  
XUYFVP: 5 mm  
XUYFVER: 3 mm

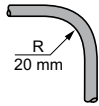

**Metal reinforced sheath**  
XUYFVP: 5 mm  
XUYFVER: 3.5 mm

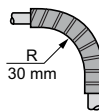

**High temperature sheath**  
XUYFVP: 5 mm  
XUYFVER: 5 mm

R = minimum bend radius

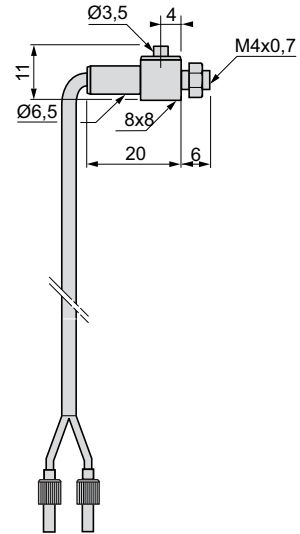
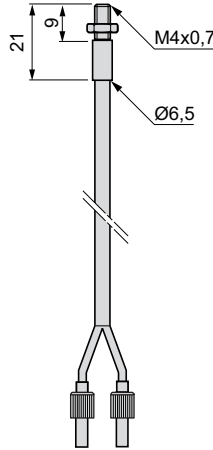

**Applications**

- Detection in high temperature environment (up to 200 °C)
- Detection in aggressive environment
- Application requiring high level of performance

**References**

Type of end fitting	Straight			Lateral		
	Standard	Metal reinforced	High temperature	Standard	Metal reinforced	High temperature
Sheath						
References with 0.60 m long fibre (1)	<b>XUYFVPSD61</b>	<b>XUYFVPM61</b>	<b>XUYFVPTD61</b>	<b>XUYFVPSL61</b>	<b>XUYFVPM61</b>	<b>XUYFVPTL61</b>
Nominal sensing distance Sn (mm)	80	80	80	80	80	80
Weight (kg)	0.040	0.045	0.052	0.042	0.056	0.056

**Characteristics**

<b>Fibre</b>	400 strands per mm <sup>2</sup>
<b>Usable diameter of fibre</b>	1.2 mm
<b>Ambient air temperature</b>	For operation <b>Standard:</b> - 25...+ 60 °C <b>Metal reinforced:</b> - 25...+ 120 °C <b>High temperature:</b> -25...+ 200 °C
<b>Detection end fitting</b>	Nickel plated brass
<b>Materials</b>	Fibre: 50 µ glass Sheath: <b>Standard:</b> PVC + thermo polyolefine, <b>Metal reinforced:</b> spiralled metal + polyolefine <b>High temperature:</b> flexible stainless steel

(1) For 1 m long fibre, replace 61 in the reference by 101. Example: XUYFVPSD61 becomes XUYFVPSD101 for a 1 m long fibre.  
For 1.5 m long fibre, replace 61 in the reference by 151. Example: XUYFVPM61 becomes XUYFVPM151 for a 1.5 m long fibre.  
For 2 m long fibre, replace 61 in the reference by 201. Example: XUYFVPTD61 becomes XUYFVPTD201 for a 2 m long fibre.

**Detection and attenuation curves**

**XUYFVP●●61**

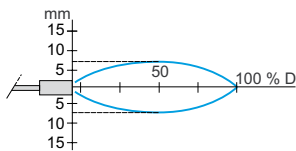

**Attenuation related to length**

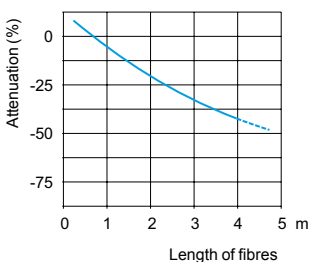

**Bending influence**

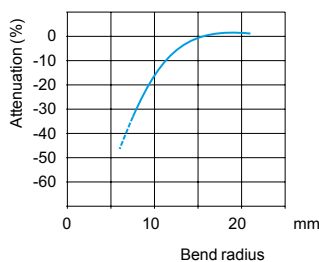

**Material influence**

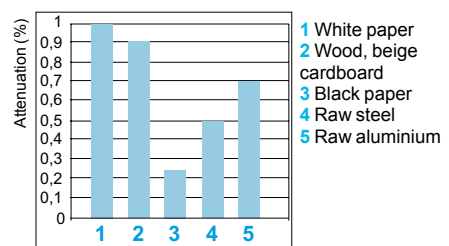



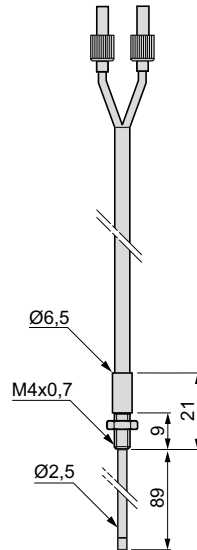
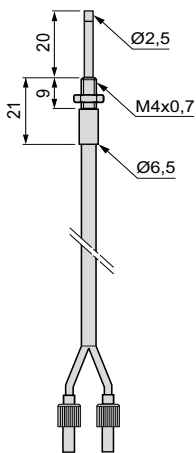

Extended			Pliable		
Standard	Metal reinforced	High temperature	Standard	Metal reinforced	High temperature
<b>XUYFVPSA61 (1)</b>	<b>XUYFVMA61 (1)</b>	<b>XUYFVPTA61 (1)</b>	<b>XUYFVPSA61 (1)</b>	<b>XUYFVMA61 (1)</b>	<b>XUYFVPTA61 (1)</b>
80	80	80	80	80	80
0.041	0.046	0.053	0.043	0.057	0.057
400 strands per mm <sup>2</sup>					
1.2 mm					
<b>Standard:</b> - 25...+ 60 °C					
<b>Metal reinforced:</b> - 25...+ 120 °C					
<b>High temperature:</b> - 25...+ 200 °C					
Nickel plated brass					
50 µ glass					
<b>Standard:</b> PVC + thermo polyolefine,					
<b>Metal reinforced:</b> spiralled metal + polyolefine					
<b>High temperature:</b> flexible stainless steel					

(1) For 1 m long fibre, replace 61 in the reference by **101**. Example: XUYFVPSA61 becomes **XUYFVPSA101** for a 1 m long fibre.  
 For 1.5 m long fibre, replace 61 in the reference by **151**. Example: XUYFVMA61 becomes **XUYFVMA151** for a 1.5 m long fibre.  
 For 2 m long fibre, replace 61 in the reference by **201**. Example: XUYFVPTA61 becomes **XUYFVPTA201** for a 2 m long fibre.

### “GLASS” fibre optics for thru-beam system

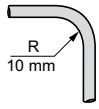

**Standard sheath**  
External Ø  
XUYFVP: 5 mm  
XUYFVER: 3 mm

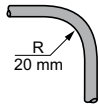

**Metal reinforced sheath**  
XUYFVP: 5 mm  
XUYFVER: 3.5 mm

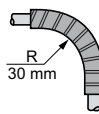

**High temperature sheath**  
XUYFVP: 5 mm  
XUYFVER: 5 mm

R = minimum bend radius

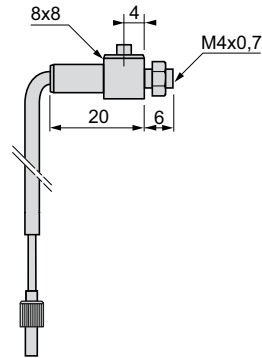
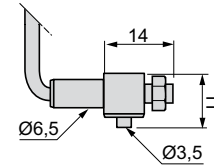
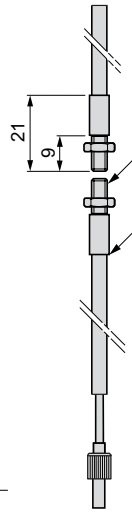

#### Applications

- Detection in high temperature environment (up to 200 °C)
- Detection in aggressive environment
- Application requiring high level of performance

#### References

Type of end fitting				Lateral		
	Standard	Metal reinforced	High temperature	Standard	Metal reinforced	High temperature
<b>Sheath</b>						
References with 0.6 m long fibre (1)	<b>XUYFVERSD61</b>	<b>XUYFVERMD61</b>	<b>XUYFVERTD61</b>	<b>XUYFVERSL61</b>	<b>XUYFVERML61</b>	<b>XUYFVERTL61</b>
Nominal sensing distance Sn (mm)	200	200	200	200	200	200
Weight (kg)	0.042	0.046	0.060	0.052	0.061	0.075

#### Characteristics

<b>Fibre</b>		400 strands per mm <sup>2</sup>
<b>Usable diameter of fibre</b>		1.2 mm
<b>Ambient air temperature</b>	For operation	<b>Standard:</b> - 25...+ 60 °C, <b>Metal reinforced:</b> - 25...+ 120 °C <b>High temperature:</b> - 25...+ 200 °C
<b>Detection end fitting</b>		Nickel plated brass
<b>Materials</b>	Fibre	50 µ glass
	Sheath	<b>Standard:</b> PVC + thermo polyolefine <b>Metal reinforced:</b> spiralled metal + polyolefine <b>High temperature:</b> flexible stainless steel

(1) For 1 m long fibre, replace 61 in the reference by 101. Example: XUYFVERSD61 becomes XUYFVERSD101 for a 1 m long fibre.  
For 1.5 m long fibre, replace 61 in the reference by 151. Example: XUYFVERMD61 becomes XUYFVERMD151 for a 1.5 m long fibre.  
For 2 m long fibre, replace 61 in the reference by 201. Example: XUYFVERTD61 becomes XUYFVERTD201 for a 2 m long fibre.

#### Detection and attenuation curves

##### XUYFVER●●61

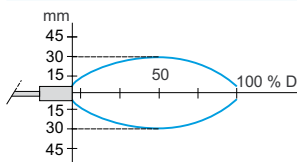

##### Attenuation related to length

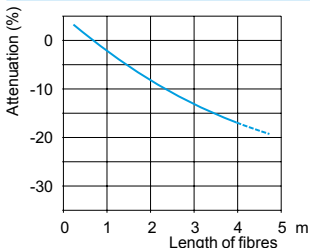

##### Bending influence

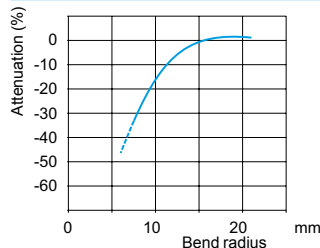

##### Material influence

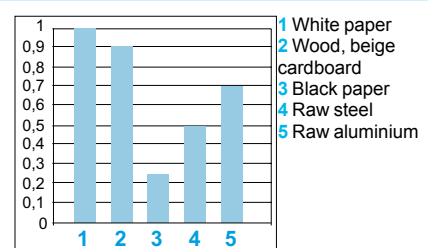

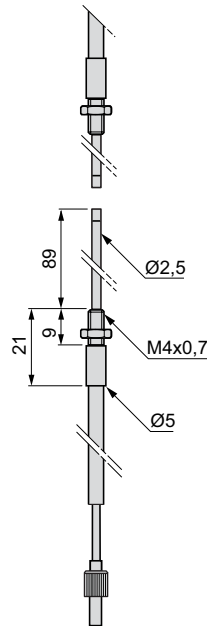
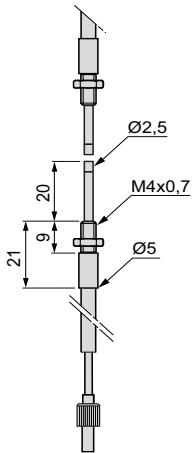

Extended			Pliable		
Standard	Metal reinforced	High temperature	Standard	Metal reinforced	High temperature
<b>XUYFVERSA61 (1)</b>	<b>XUYFVERMA61 (1)</b>	<b>XUYFVERTA61 (1)</b>	<b>XUYFVERSC61 (1)</b>	<b>XUYFVERMC61 (1)</b>	<b>XUYFVERTC61 (1)</b>
80	80	80	80	80	80
0.043	0.047	0.061	0.053	0.061	0.076
400 strands per mm <sup>2</sup>					
1.2 mm					
<b>Standard:</b> - 25...+ 60 °C,					
<b>Metal reinforced:</b> - 25...+ 120 °C					
<b>High temperature:</b> - 25...+ 200 °C					
Nickel plated brass					
50 µ glass					
<b>Standard:</b> PVC + thermo polyolefine					
<b>Metal reinforced:</b> spiralled metal + polyolefine					
<b>High temperature:</b> flexible stainless steel					

(1) For 1 m long fibre, replace 61 in the reference by **101**. Example: XUYFVERSA61 becomes **XUYFVERSA101** for a 1 m long fibre.  
 For 1.5 m long fibre, replace 61 in the reference by **151**. Example: XUYFVERMA61 becomes **XUYFVERMA151** for a 1.5 m long fibre.  
 For 2 m long fibre, replace 61 in the reference by **201**. Example: XUYFVERTA61 becomes **XUYFVERTA201** for a 2 m long fibre.

# Photo-electric sensors

OsiSense XU Application

Fibre optics for amplifier

“GLASS” fibres with end fittings

For diffuse and thru-beam systems

## Accessories

### Focusers for diffuse system fibre optics

Description	For use with	Nominal sensing distance (Sn)	Unit reference	Weight
		mm		kg
<b>Focusers</b> for pinpoint reading of reference marks, contrasts, faults, etc.	XUYFVERSD61	10	<b>XUY1120</b>	0.003
	XUYFVERMD61	30	<b>XUY1125</b>	0.004
	XUYFVERTD61			

### Focusers for thru-beam system fibre optics

Description	For use with	Nominal sensing distance (Sn)	Unit reference	Weight
		mm		kg
<b>Focusers</b> for increasing sensing distances (sold in lots of 2)	XUYFVERSD61	800	<b>XUY1121 (1)</b>	0.004
	XUYFVERMD61	3000	<b>XUY1124 (2)</b>	0.012
	XUYFVERTD61	800	<b>XUY1122 (1)</b>	0.006

(1) 70° max.

(2) 250° max.

# Photo-electric sensors

OsiSense XU Application

Fibre optics for amplifier

“GLASS” fibres with end fittings

For diffuse and thru-beam systems

## Focusers

XUY1120

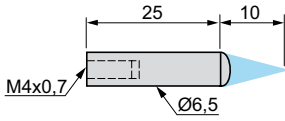

XUY1125

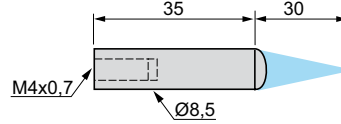

XUY1121

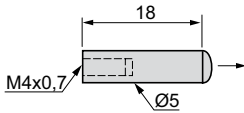

XUY1124

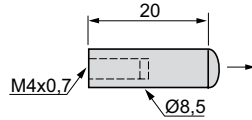

XUY1122R

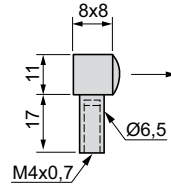

# Photo-electric sensors

OsiSense XU Application

Fibre optics for amplifier

Ecofibre system in "PLASTIC" for customer assembly

### Ecofibre concept

Assemble your own fibre optics.

### Fibres without end fitting

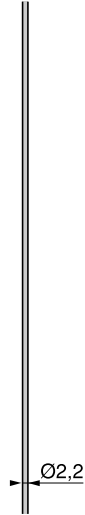

### End fittings

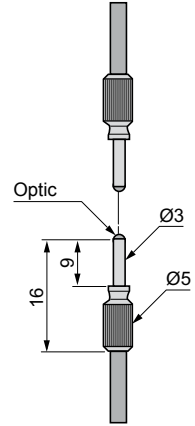
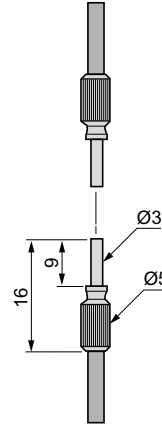
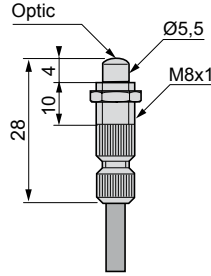

### End fittings

Nominal sensing distance Sn (mm)	70	200	800
Reference	XUYA110	XUYA210	XUYA211
Weight (kg)	0.009	0.004	0.004

### Fibres without end fitting

Type of fibre

Single fibre, plastic, single strand



Length (m)	1	10	50
Usable diameter (mm)	1	1	1
External diameter (mm)	2.2	2.2	2.2
Reference	XUYA005	XUYA00510	XUYA00550
Weight (kg)	0.006	0.042	0.220

### Curves

End fittings	XUYA110	XUYA210	XUYA211
--------------	---------	---------	---------

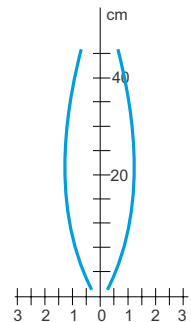
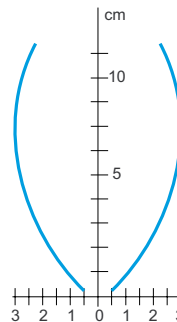
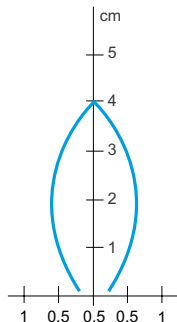

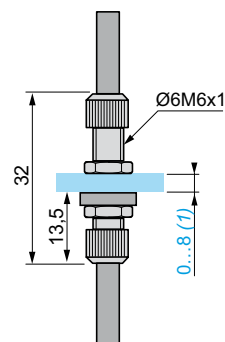
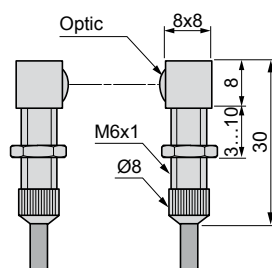
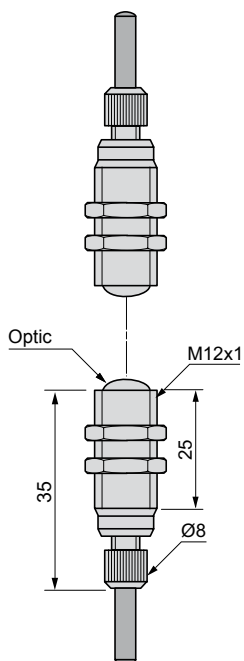
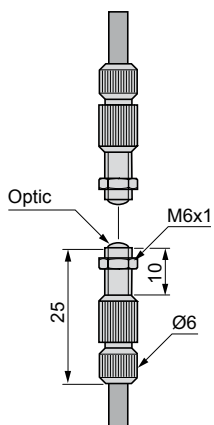

End fitting for passing through partition

(1) Ø 6.2 cut-out

1200	4000	1200	-
<b>XUYA212</b>	<b>XUYA213</b>	<b>XUYA220</b>	<b>XUYA310</b>
0.011	0.045	0.018	0.017

Single fibre, plastic, multistrand



Dual fibre, plastic, single strand

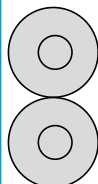

1	1
1	1
2.2	2.2
<b>XUYAU005</b>	<b>XUYFP2BRINA005B</b>
<b>0.006</b>	<b>0.080</b>

<b>XUYA212</b>	<b>XUYA213</b>	<b>XUYA220</b>
----------------	----------------	----------------

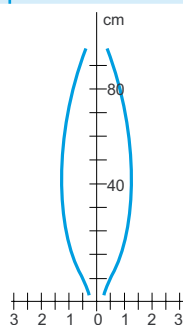
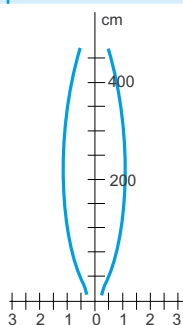
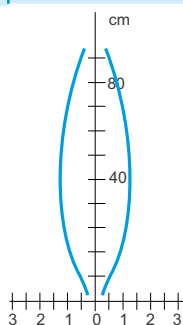

# Photo-electric sensors

## OsiSense XU Application

### Amplifiers for plastic or glass fibre optics

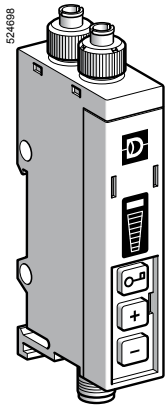

XUYAFP966S

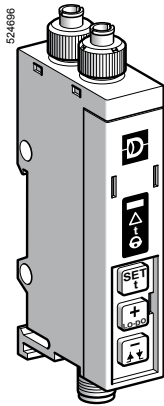

XUYAFP946S

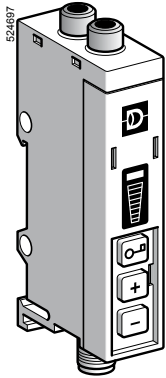

XUYAFV966S

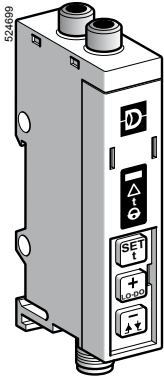

XUYAFV946S

#### Amplifiers for plastic fibre optics (1)

Sensing distance (Sn) m	Function	Output	Connection	Reference	Weight kg
Depending on fibre	NO/NC	PNP/NPN	Pre-cabled	<b>XUYAFP966S</b>	0.124
	dpg. on wiring		M8 connector	<b>XUYAFPCO966S</b>	0.056

#### Adjustment using +/- button (2)

Depending on fibre	NO/NC	PNP/NPN	Pre-cabled	<b>XUYAFP946S</b>	0.124
	programmable		M8 connector	<b>XUYAFPCO946S</b>	0.056

#### Amplifiers for glass fibre optics

Sensing distance (Sn) m	Function	Output	Connection	Reference	Weight kg
Depending on fibre	NO/NC	PNP/NPN	Pre-cabled	<b>XUYAFV966S</b>	0.116
	dpg. on wiring		M8 connector	<b>XUYAFVCO966S</b>	0.047

#### Adjustment using teach mode (3)

Depending on fibre	NO/NC	PNP/NPN	Pre-cabled	<b>XUYAFV946S</b>	0.124
	programmable		M8 connector	<b>XUYAFVCO946S</b>	0.047

#### Accessories

Description	Details	Length of cable m	Reference	Weight kg
Pre-wired M8 connector	Straight	2	<b>XZCP0941L2</b>	0.080
	Elbowed (90°)	2	<b>XZCP1041L2</b>	0.080
	Straight	5	<b>XZCP0941L5</b>	0.180
	Elbowed (90°)	5	<b>XZCP1041L5</b>	0.180

(1) Fibre trimmer included

(2) Indication of level by bargraph, adjustment by pressing button

(3) Fine mode or standard mode, adjustment using teach

#### Characteristics

Sensor type		XUYAF●9●6S	XUYAFCO●6S
Product certifications		CE, cULus (4)	
Connection	Connector	–	M8, 4-pin
	Pre-cabled	Length: 2 m	–
Nominal sensing distance (Sn)		Depending on fibre optic used	
Type of transmission	LED	Red LED	
	Modulation frequency	8 kHz	
Sensitivity adjustment		Using teach (fine mode or standard mode) and/or +/- button, depending on model	
Degree of protection	Conforming to IEC 60529	IP 65	
Ambient air temperature	For storage	°C	- 20...+ 80
	For operation	°C	0...+ 60
Materials		Polycarbonate	
Immunity to ambient light	Incandescent bulb	Lux	10 000
	Natural light	Lux	20 000
Rated supply voltage		V $\overline{\text{---}}$ 12...24 with protection against reverse polarity	
Voltage limits (including ripple)		V $\overline{\text{---}}$ 10...30	
Current consumption, no-load		mA < 40	
Switching capacity		mA 100 with overload and short-circuit protection	
Voltage drop, closed state		V < 2	
Maximum switching frequency		kHz < 1	
External input (5)	Active	V	< 1.4
	Inactive	V	> 3
Delays	Response and recovery	ms	< 0.5
Output time delay (5)	Range	s	0...5 in 11 adjustment increments
	Duration of each increment	ms	First increment 40 ms then 500 ms for each press

(4) This product is UL Listed if supplied by a class II or isolated supply delivering  $\overline{\text{---}}$  30 V max. (isolated transformer for example) and protected by a UL fuse rated at 3 A max.

(5) Only for models with teach mode.

#### ■ Applications using plastic fibre optics

- Monitoring position or presence of parts on an assembly or packing machine
- Detection of objects on small conveyor
- Use of fibre optics in vibratory environments (robot arms)
- Detection of reference and colour marks in packaging

#### ■ Applications with glass fibre optics

- Monitoring position or presence of parts on an assembly or packing machine
- Detection of presence of parts in a plastic mould
- Detection in aggressive environments
- Detection of items exiting an oven (high temperature fibres)



### Presentation

#### XUYAF●, adjustment using button

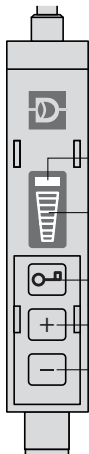

- 1 Detection
- 2 Indication of the level of adjustment
- 3 Keypad locking
- 4 Sensitivity increase
- 5 Sensitivity decrease

#### XUYAF●, adjustment using teach mode

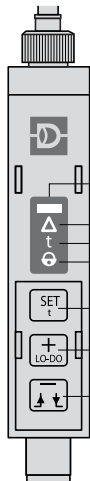

- 1 Detection
- 2 Dirty optics, limit of detection, alignment assistance
- 3 Time delay active
- 4 Action keypad, keypad locking
- 5 Automatic adjustment of the threshold, access to special functions
- 6 Sensitivity increase, direct/inverse output, time delay increase
- 7 Sensitivity decrease, On-delay, Off-delay inversion, time delay decrease

### Dimensions

#### XUYAFP966S/AFPCO966S

Mounting on 35 mm rail

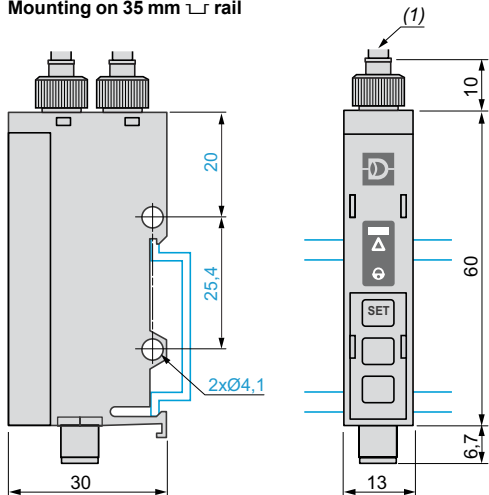

(1) Plastic fibre optic: Ø 2.2 mm

#### XUYAFV966S/AFVCO966S

Mounting on 35 mm rail

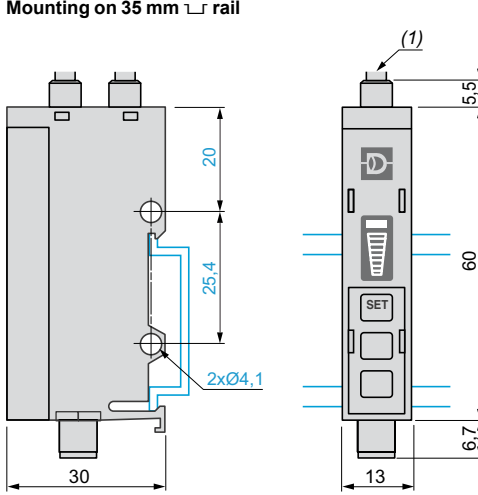

(1) Glass fibre optic: Ø 3 mm

### Wiring schemes

#### XUYAFP966/AFV966

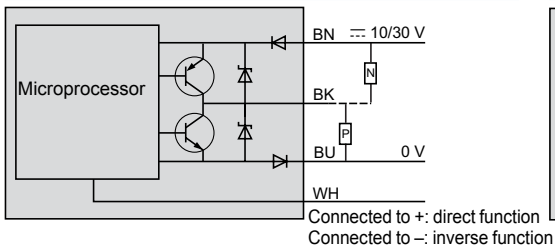

#### XUYAFP946/AFV946

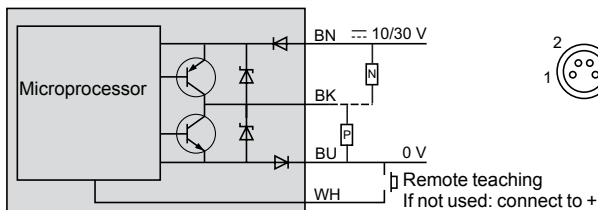

#### M8 connector

Pin N°	Colour
1	BN Brown
2	WH White
3	BU Blue
4	BK Black

### Application examples

#### Thru-beam and diffuse system detection

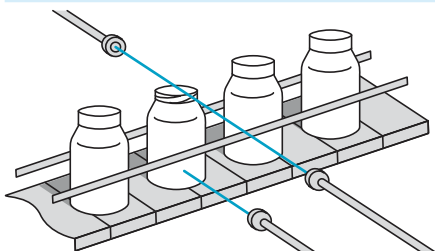

#### Thru-beam system detection

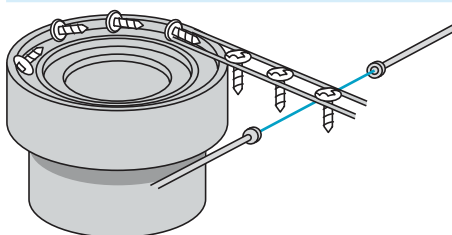

# Photo-electric sensors

OsiSense XU Application, conveying series  
Compact design  
Two-wire AC, solid-state output

## Compact design

### Pre-cabled and connector versions

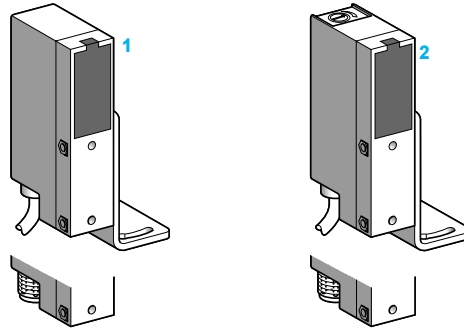

System	Reflex 1	Polarised reflex 1	Diffuse 2
Type of transmission	Infrared	Red	Infrared
Nominal sensing distance (Sn)	6 m (with Ø 80 mm reflector)	4 m (with Ø 80 mm reflector)	0.7 m

## References

2-wire	NC function	Connection	Pre-cabled	XULA06021	XULA040219	XULA700115
			Connector	XULA06021K	XULA040219K	XULA700115K
	NO function	Connection	Pre-cabled	XULA06011	XULA040119	XULA700215
			Connector	XULA06011K	XULA040119K	XULA700215K
Weight (kg)		Connection	Pre-cabled	0.195		
			Connector	0.135		

## Characteristics

Product certifications		CE. Special H7 version: UL, CSA	
Ambient air temperature	For operation	- 25...+ 60 °C	
	For storage	- 40...+ 80 °C	
Vibration resistance	Conforming to IEC 60068-2-6	7 gn, amplitude ± 2 mm (f = 10...55 Hz)	
Shock resistance	Conforming to IEC 60068-2-27	20 gn, duration 11 ms	
Degree of protection	Conforming to IEC 60529	IP 65	
	Conforming to NF C 20-010	IP 651	
Connection	Pre-cabled	Diameter 6 mm, length 2 m (1), wire c.s.a.: 2 x 0.34 mm <sup>2</sup>	
	Connector	1/2"-20UNF	
Materials	Case	ABS/PC	
	Lenses	PMMA	
	Cable	PVC	
Rated supply voltage		~ or ≡ 24...240 V	
Voltage limits		~ or ≡ 20...264 V	
Switching capacity (2)	Sealed	Maximum	~ 12 or ≡ 12 (resistive load): 0.5 A/240 V ~ 140 (inductive load): 0.3 A/240 V ≡ 13 (inductive load): 0.1 A/240 V; 0.2 A/110 V; 0.5 A/48 V
		Minimum	5 mA
Inrush		3000 mA	
Voltage drop, closed state		≤ 3 V (I = 0.1...0.5 A); ≤ 5.5 V (I = 10 mA); ≤ 10 V (I = 5 mA)	
Residual current, open state		≤ 1.7 mA (on ~); ≤ 1.5 mA (on ≡)	
Maximum switching frequency		20 Hz	
Delays	First-up	≤ 300 ms	
	Response	≤ 20 ms	
	Recovery	≤ 20 ms	

Function table	Function	Reflex system		Function	Diffuse system	
		No object present in the beam	Object present in the beam		No object present in the beam	Object present in the beam
Output state indicator (illuminated when sensor output is ON)	NC			NO		
	NO			NC		

(1) For a sensor with a 5 m long cable add L05 to the end of the reference; for a 10 m long cable add L10 to the end of the reference.

Example: sensor XULA06021 with 5 m cable becomes XULA06021L05

(2) These sensors do not incorporate overload or short-circuit protection and therefore, it is strongly advised to connect a "quick-blow" fuse in series with the load (see page 165).

### Detection curves

#### Thru-beam system

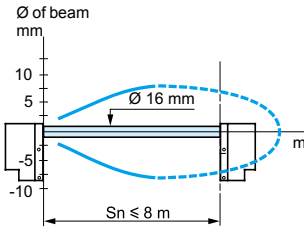

#### Reflex system

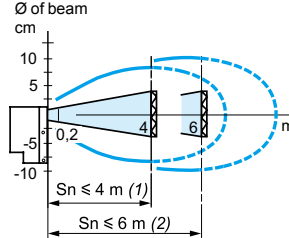

(1) Polarised  
(2) Infrared

#### Diffuse system

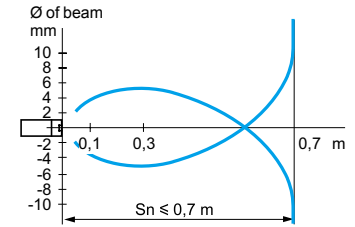

Object 20 x 20 cm  
White 90%

### Schemes

#### Wiring schemes (2-wire ~)

**NO function** (no object present)

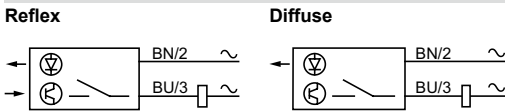

**NC function** (no object present)

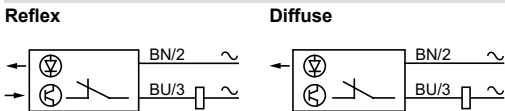

**Attention:** it is essential to connect a load in series with the sensor

**Connector scheme** (sensor connector pin view)

**Solid-state output** (reflex and diffuse system)



### Excess gain curves (ambient temperature: + 25 °C)

#### Thru-beam system

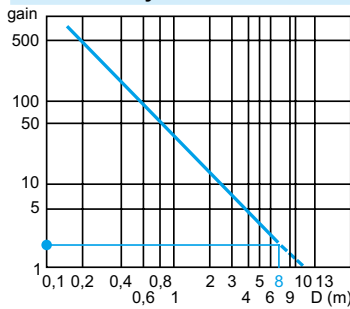

#### Reflex system

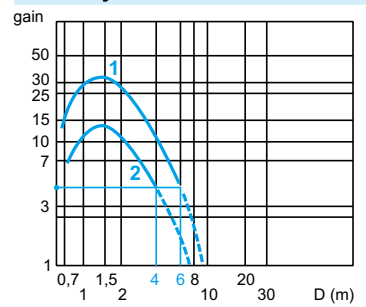

With reflector XUZC80

1 Infrared  
2 Polarised

#### Diffuse system

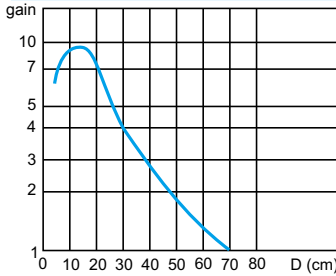

Object 20 x 20 cm  
White 90%

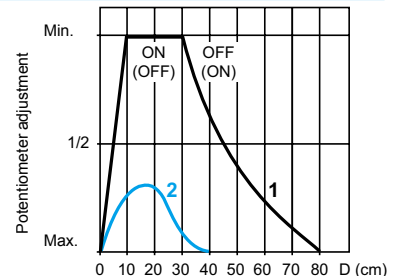

Object 20 x 20 cm  
1 White 90 %  
2 grey 18 %

### Dimensions (The bracket XULZ41 is included with the sensor)

#### Sensor

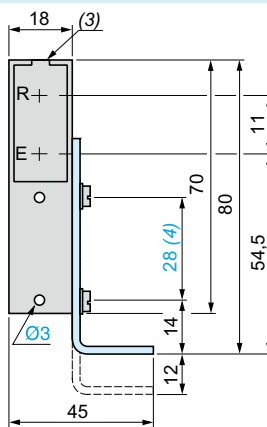
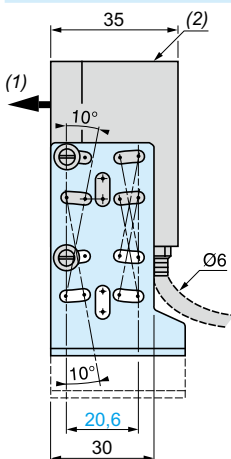

#### Bracket fixing

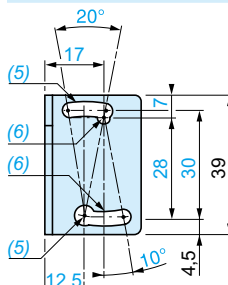

(1) Optical axis  
(2) Sensitivity potentiometer (diffuse model)  
(3) Output LED indicator

(4) Front fixing (∅ 3 screws and inserts included)  
(5) 1 elongated hole ∅ 4.1 x 10 and 1 x ∅ 4.1  
(6) 1 elongated hole ∅ 3.1 x 10 and 1 x ∅ 3.1

# Photo-electric sensors

OsiSense XU Application

Conveying and access control series

Compact design with teach mode adjustment

Five-wire AC or DC, 1 CO relay output

Three-wire DC, solid-state output

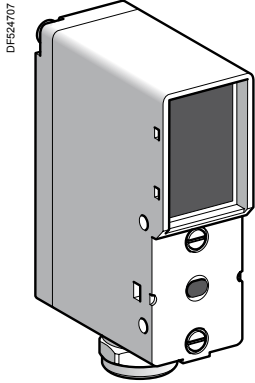

XUY95●●

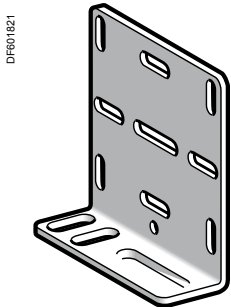

XUZA49

Diffuse system (1)					
Sensing distance (Sn) m	Function	Output	Reference	Weight kg	
<b>DC</b>					
1.5	NO/NC programmable	PNP/NPN	XUY954S	0.130	
4	NO/NC programmable	PNP/NPN	XUY952S	0.130	
<b>AC or DC</b>					
1.5	NO/NC programmable	Relay	XUY954R	0.150	
4	NO/NC programmable	Relay	XUY952R	0.150	
Polarised reflex system (2)					
Sensing distance (Sn) m	Function	Output	Reference	Weight kg	
<b>DC</b>					
6	NO/NC programmable	PNP/NPN	XUYB954S	0.130	
10	NO/NC programmable	PNP/NPN	XUYB952S	0.130	
<b>AC or DC</b>					
6	NO/NC programmable	Relay	XUYB954R	0.150	
10	NO/NC programmable	Relay	XUYB952R	0.150	
Fixing accessory					
Description				Reference	Weight kg
Metal fixing bracket				XUZA49	0.120

(1) On 300 x 300 mm white paper

(2) With Ø 84 mm reflector

## Characteristics

	XUY P954S	XUY P954R	XUY P952S	XUY P952R	XUY B954S	XUY B954R	XUY B952S	XUY B952R
<b>Product certifications</b>	CE, cULus for XUY954S/952S and XUYB954S/952S							
<b>Connection</b>	Screw terminals							
<b>Nominal sensing distance (Sn)</b>	1.5		4		6		10	
Adjustment using teach (fine or standard mode)								
<b>Type of transmission</b>	LED				Infrared			
<b>Degree of protection</b>	Conforming to IEC 60529				IP 65 and IP 67			
<b>Ambient air temperature</b>	For storage		°C - 20...+ 80					
	For operation		°C 0...+ 60					
<b>Materials</b>	Polycarbonate							
<b>Immunity to ambient light</b>	Incandescent bulb		Lux 10 000 at 5° to the optical axis					
	Natural light		Lux 20 000 at 5° to the optical axis					
<b>Indicator lights</b>	Green LED		Output signal					
	Red LED		Dirty optics, limit of detection, alignment assistance, time delay active, time function indicator					
<b>Voltage limits</b>	10...30 V		●		●		●	
(including ripple)	~ 20...250 V		●		●		●	
<b>Current consumption, no-load</b>	mA 50		50		50		50	
	VA -		2		2		2	
<b>Type of output</b>	PNP/NPN		Relay		PNP/NPN		Relay	
<b>Switching capacity</b>	PNP/NPN		mA 100 with overload and short-circuit protection					
	Relay		A 3 (max. continuous)					
<b>Voltage drop, closed state</b>	PNP/NPN		V At 100 mA: < 2; at 10 mA: < 1					
<b>Maximum switching frequency</b>	Hz 1000		25		60		25	
<b>Delays</b>	Response and recovery		ms 0.5		20		8	
<b>Test input</b>	Active		V < 1.4		-		< 1.4	
	Inactive		V > 3		-		> 3	
<b>Output time delay</b>	Type		Retriggerable: leading edge and/or trailing edge					
	Duration of each increment		ms 0 to 11 s in 23 adjustment increments of 50 ms, then 0.5 s per press					
<b>Adjustment</b>	Using teach mode and/or fine manual adjustment							

■ Applications

- Detection of belt breakage
- Material handling
- Access control

# Photo-electric sensors

OsiSense XU Application

Conveying and access control series

Compact design with teach mode adjustment

Five-wire AC or DC, 1 CO relay output

Three-wire DC, solid-state output

## Description

Rear view

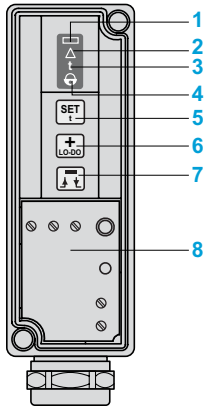

Indicator lights

- 1 - Output signal: Green LED
- 2 - Dirty optics: Red LED
- Limit of detection: Red LED
- Alignment assistance: flashing red LED
- 3 - Activation/adjustment of time delay: Red LED
- 4 - Action keypad
- Keypad: Action/Locking

Controls

- 5 - Automatic adjustment of threshold
- Access to special functions
- Zero reset of time delay
- 6 - Sensitivity increase
- NO/NC programming
- Time delay increase
- 7 - Sensitivity decrease
- Inversion of time delay setting: On-delay, Off-delay
- Time delay decrease
- 8 - Access to terminals

Note: Both the red and green LEDs flash in the event of a short-circuit on the output (for XUYP●95●S and XUYB●95●S versions).

## Dimensions

Sensors XUY●95●S and XUY●95●R

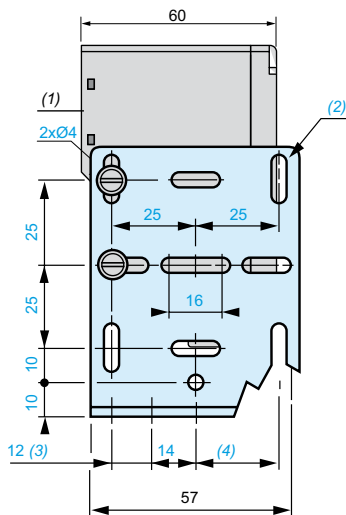

- (1) Optical axis.
- (2) 8 elongated holes  $\varnothing 4.2 \times 10$ .
- (3) 2 elongated holes  $\varnothing 6.5 \times 10$ .
- (4) 1 elongated hole  $\varnothing 6.5 \times 24$ .

Bracket fixing XUZA49

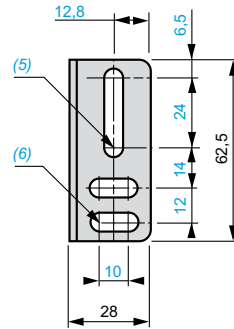
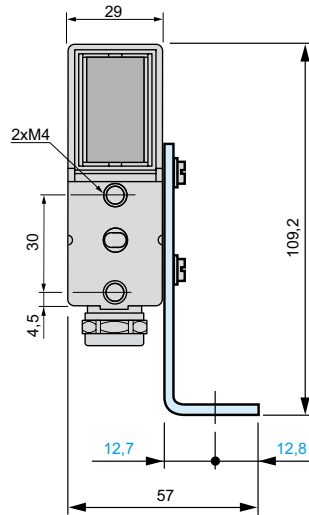

- (5) 2 elongated holes  $\varnothing 6.5 \times 16.5$ .
- (6) 1 elongated hole  $\varnothing 6.5 \times 30.5$ .

## Wiring schemes

XUY●95●S

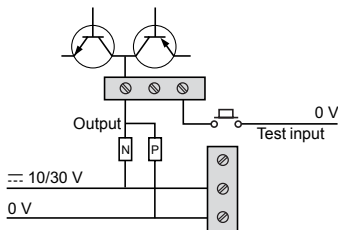

XUY●95●R

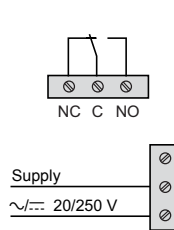

250 V, 1.5 mm<sup>2</sup> terminals.

## Application examples

Monitoring for blockages on a baggage conveyor

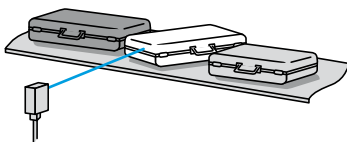

Monitoring of gluing, fastening or labelling operations

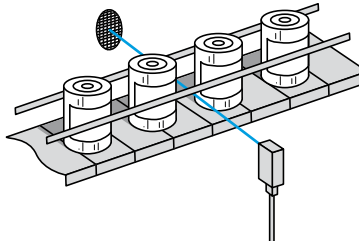

# Photo-electric sensors

## OsiSense XU Application

### Design 18

Two-wire AC <sup>(1)</sup> or DC, solid-state output with adjustable sensitivity

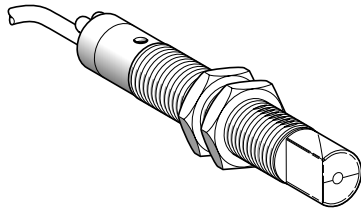

XU5M18M●230W  
XU8M18M●230W

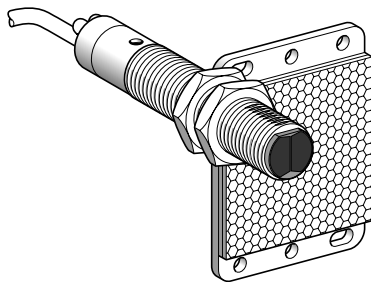

XU9M18M●230

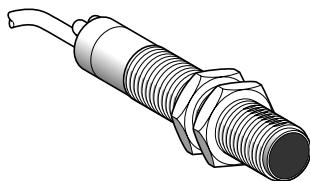

XU2M18M●230

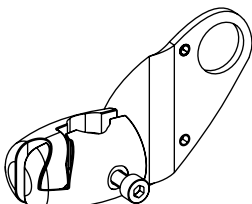

XUZA118

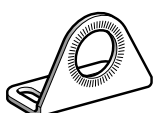

XUZA218

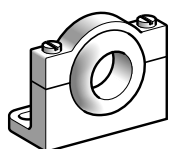

XUZA218

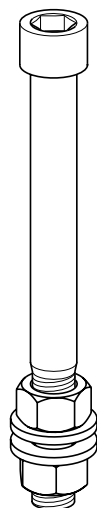

XUZZ001

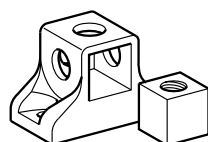

XUZZ003

#### Diffuse system with adjustable background suppression

Sensing distance (Sn) m	Function	Line of sight	Connection	Reference	Weight kg
0.12	NO	Along case axis	Pre-cabled (L = 2 m) (2)	XU8M18MA230	0.150
			1/2"-20UNF	XU8M18MA230K	0.075
		90° to case axis	Pre-cabled (L = 2 m) (2)	XU8M18MA230W	0.150
	NC	Along case axis	Pre-cabled (L = 2 m) (2)	XU8M18MB230	0.150
			1/2"-20UNF	XU8M18MB230K	0.075
		90° to case axis	Pre-cabled (L = 2 m) (2)	XU8M18MB230W	0.150
			1/2"-20UNF	XU8M18MB230WK	0.075

#### Diffuse system

Sensing distance (Sn) m	Function	Line of sight	Connection	Reference	Weight kg
0.40	NO	Along case axis	Pre-cabled (L = 2 m) (2)	XU5M18MA230	0.150
			1/2"-20UNF	XU5M18MA230K	0.075
		90° to case axis	Pre-cabled (L = 2 m) (2)	XU5M18MA230W	0.150
	NC	Along case axis	Pre-cabled (L = 2 m) (2)	XU5M18MB230	0.150
			1/2"-20UNF	XU5M18MB230K	0.075
		90° to case axis	Pre-cabled (L = 2 m) (2)	XU5M18MB230W	0.150
			1/2"-20UNF	XU5M18MB230WK	0.075

#### Polarised reflex system <sup>(3)</sup>

Sensing distance (Sn) m	Function	Line of sight	Connection	Reference	Weight kg
2	NO	Along case axis	Pre-cabled (L = 2 m) (2)	XU9M18MA230	0.170
			1/2"-20UNF	XU9M18MA230K	0.090
		90° to case axis	Pre-cabled (L = 2 m) (2)	XU9M18MA230W	0.170
	NC	Along case axis	Pre-cabled (L = 2 m) (2)	XU9M18MB230	0.170
			1/2"-20UNF	XU9M18MB230K	0.095
		90° to case axis	Pre-cabled (L = 2 m) (2)	XU9M18MB230W	0.170
			1/2"-20UNF	XU9M18MB230WK	0.090

#### Thru-beam system <sup>(4)</sup>

Sensing distance (Sn) m	Function	Line of sight	Connection	Reference	Weight kg
15	NO	Along case axis	Pre-cabled (L = 2 m) (2)	XU2M18MA230	0.285
			1/2"-20UNF	XU2M18MA230K	0.155
		90° to case axis	Pre-cabled (L = 2 m) (2)	XU2M18MA230W	0.285
	NC	Along case axis	Pre-cabled (L = 2 m) (2)	XU2M18MA230WK	0.155
			1/2"-20UNF	XU2M18MA230WK	0.155
		90° to case axis	Pre-cabled (L = 2 m) (2)	XU2M18MB230	0.285
			1/2"-20UNF	XU2M18MB230K	0.155
			Pre-cabled (L = 2 m) (2)	XU2M18MB230W	0.285
			1/2"-20UNF	XU2M18MB230WK	0.155

#### Fixing accessories <sup>(5)</sup>

Description	Reference	Weight kg
3D fixing kit for use on M12 rod, for XU●M18 or XUZZ50	XUZZ003	0.170
M12 rod	XUZZ001	0.050
Support for M12 rod	XUZZ003	0.150
Stainless steel fixing bracket	XUZA118	0.045
Plastic fixing bracket with adjustable ball-joint	XUZA218	0.035

(1) These sensors do not incorporate overload or short-circuit protection and therefore, it is essential to connect a 0.4 A "quick-blow" fuse in series with the load.

(2) For a 5 m long cable add L5.

Example: XU2M18MA230 becomes XU2M18MA230L5.

(3) 50 x 50 mm reflector XUZZ50 included with polarised reflex system.

(4) Comprising both thru-beam transmitter and receiver.

(5) For further information, see page 164.

Characteristics		XU2M, XU5M, XU8M, XU9M	XU2M, XU5M, XU8M, XU9M●●●●●●●●K
Sensor type		UL, CSA, CE	
Product certifications		UL, CSA, CE	
Connection	Connector	–	1/2"-20UNF
	Pre-cabled	Length: 2 m	–
Sensing distance nominal $S_n$ / maximum (excess gain = 2) (excess gain = 1)	m	0.12 / 0.12 diffuse with background suppression	
	m	0.4 / 0.6 diffuse	
	m	2 / 3 polarised reflex	
	m	15 / 20 thru-beam	
Type of transmission		Infrared, except XU9 (red)	
Degree of protection	Conforming to IEC 60529	IP 67, double insulation □	IP 67
Storage temperature		°C -40...+70	
Operating temperature		°C -25...+55	
Materials		Case: nickel plated brass; Lens: PMMA; Cable: PvR	
Vibration resistance	Conforming to IEC 60068-2-6	7 gn, amplitude $\pm 1.5$ mm (f = 10 to 55 Hz)	
Shock resistance	Conforming to IEC 60068-2-27	30 gn, duration 11 ms	
Indicator lights	Output state	Yellow LED	
	Stability	Red LED (for reflex and thru-beam only)	
Rated supply voltage		V $\sim$ 24...240	
Voltage limits (including ripple)		V $\sim$ 20...264	
Residual current, open state		mA < 1.5	
Switching capacity		mA 10...200 (1)	
Voltage drop, closed state		V 6	
Maximum switching frequency		Hz 25	
Delays	First-up	ms < 300	
	Response	ms < 20	
	Recovery	ms < 20	

(1) These sensors do not incorporate overload or short-circuit protection and therefore, it is essential to connect a 0.4 A "quick-blow" fuse in series with the load.

## Wiring schemes

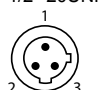
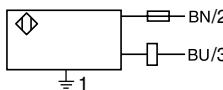
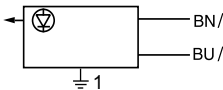
Connector	Pre-cabled	2-wire $\sim$ or $\dots$	Transmitter
1/2"-20UNF 1 $\perp$ 2 $\sim$ 3 $\sim$ 	( $\sim$ ) BU (Blue) ( $\sim$ ) BN (Brown)	 BN/2 BU/3 1 $\perp$ ⊥ on connector models	 BN/2 BU/3 1 $\perp$ ⊥ on connector models

## Detection curves

Thru-beam system	Polarised reflex system	Diffuse system	Diffuse system with adjustable background suppression
------------------	-------------------------	----------------	---

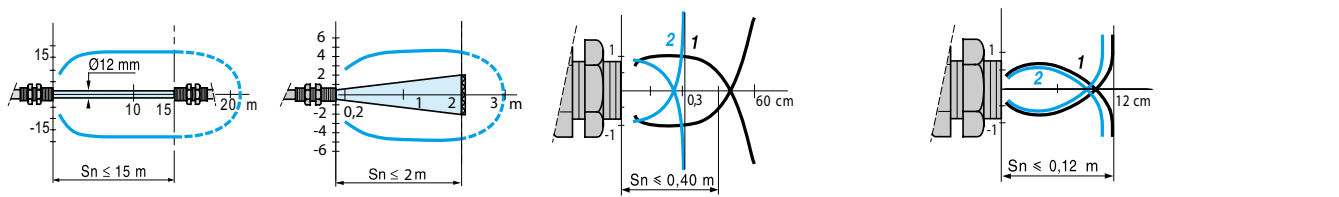

With reflector XUZC50 Object 10 x 10 cm; 1 White 90%; 2 Grey 18%

### Variation of usable sensing distance $S_u$

Potentiometer set at minimum

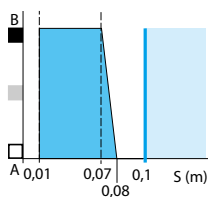

Potentiometer set at maximum

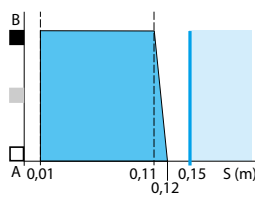

A-B: object reflection coefficient

- Black 6%
- Grey 18%
- White 90%
- Sensing range
- Non sensing zone (matt surfaces)

## Dimensions

XU●	Pre-cabled (mm)		Connector (mm)	
	a	b	a	b
Ø 18, line of sight along case axis	82	55	95	55
Ø 18, line of sight 90° to case axis	97	55	110	55

# Photo-electric sensors

OsiSense XU Application, tertiary sector series  
For access detection  
AC or DC supply  
1 CO relay output

## Compact design

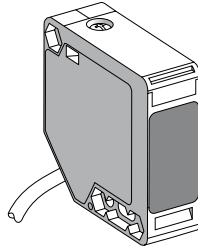

<b>System</b>	<b>Reflex</b>
<b>Type of transmission</b>	Infrared
<b>Nominal sensing distance (Sn)</b>	7 m (with 50 x 50 mm reflector)

## References

<b>5-wire</b>	NC function	<b>XUK1ARCNL2H60</b> (supplied as kit comprising: sensor, fixing bracket, 50 x 50 mm reflector and mounting instructions in French and English)	<b>XUK1ARCNL2H61</b> (supplied as kit comprising: sensor, fixing bracket, 50 x 50 mm reflector and mounting instructions in French and German)
<b>Weight (kg)</b>	0.300		

## Characteristics

<b>Product certifications</b>	UL, CSA, CE
<b>Ambient air temperature</b>	For operation: - 25...+ 55 °C. For storage: - 40...+ 70 °C
<b>Vibration resistance</b>	Conforming to IEC 60068-2-6 7 gn, amplitude ± 1.5 mm (f = 10...55 Hz)
<b>Shock resistance</b>	Conforming to IEC 60068-2-27 30 gn, duration 11 ms
<b>Degree of protection</b>	Conforming to IEC 60529 IP 65, double insulation
<b>Connection</b>	Pre-cabled: diameter 6 mm, length 2 m, wire c.s.a.: 5 x 0.34 mm <sup>2</sup> / AWG 22
<b>Materials</b>	Case: PBT; lenses: PMMA; cable: PVC
<b>Rated supply voltage</b>	~ or --- 24...240 V
<b>Voltage limits</b>	~ or --- 20...264 V
<b>Switching capacity</b>	3 A
<b>Maximum voltage on output relay contacts</b>	~ 250 V
<b>Power consumption, no-load</b>	2 W (1)
<b>Maximum switching frequency</b>	20 Hz
<b>Delays</b>	First-up: ≤ 60 ms; response: ≤ 25 ms; recovery: ≤ 25 ms

Function table	Function	Reflex system	
		No object present in the beam	Object present in the beam
<b>Output state of relay contact indicator</b> (illuminated when relay energised)	NO or NC	BK — GY WH — Relay de-energised	BK — GY WH — Relay energised

(1) No-load current consumption at ~ 220 V: ≤ 25 mA.



# Photo-electric sensors

OsiSense XU Application, tertiary sector series

For access detection

AC or DC supply

1 CO relay output

## Contents of kits XUK1ARCNL2H60 and XUK1ARCNL2H61

- reflex system photo-electric sensor,
- fixing bracket XUZASK003 (screws included),
- 50 x 50 mm reflector,
- mounting instructions
- in french and english for XUK1ARCNL2H60,
- in french and german for XUK1ARCNL2H61.



## Detection curve

Reflex system ~ or ---

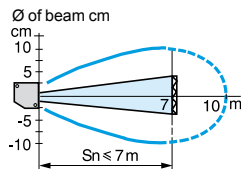

## Excess gain curve

(ambient temperature: + 25 °C)

Reflex system ~ or ---

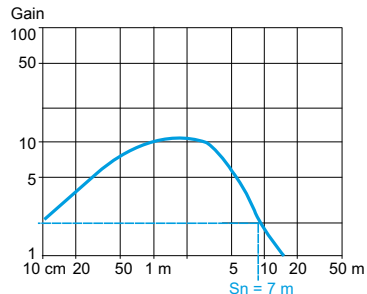

## Wiring scheme

5-wire ~ or ---

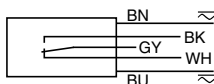

With reflector XUZC50

## Dimensions

### Sensor XUK1ARCNL2

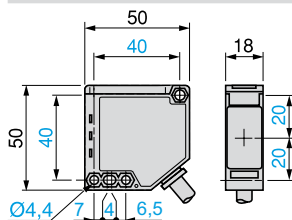

### Reflector XUZC50

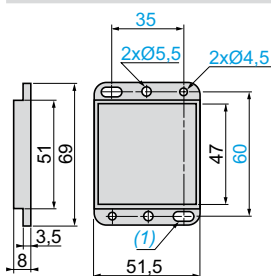

### Fixing bracket XUZASK003

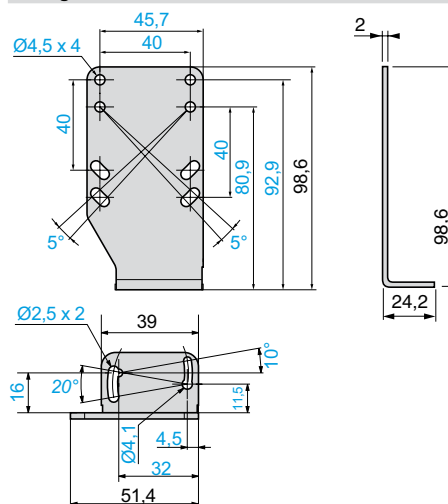

(1) 2 elongated holes Ø 4.5 x 8

## Mounting precautions

Rigid fixing for trouble free detection

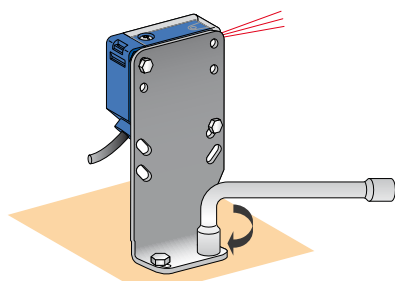

Outdoor mounting under protective cover

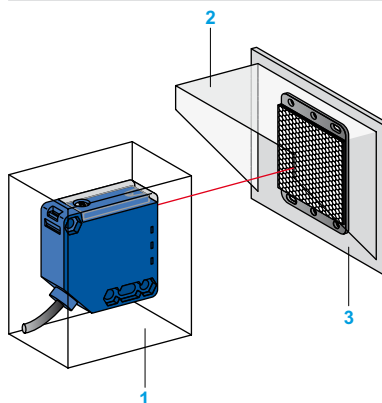

- 1 Protective housing.
- 2 Lens hood.
- 3 Thermal insulator to avoid frost or condensation forming on the optical parts.

# Photo-electric sensors

OsiSense XU Application, tertiary sector series

With integral buzzer

AC or DC supply

1 NO relay output

## Compact design

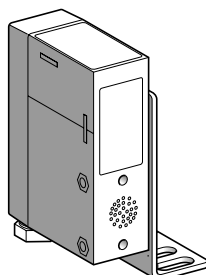





<b>System</b>	<b>Reflex</b>
<b>Type of transmission</b>	Infrared
<b>Nominal sensing distance (Sn)</b>	<b>6 m</b> (with Ø 80 mm reflector)
<b>Cable gland</b>	9P, mounted in base

## References

<b>NO function</b>	<b>XUJB06031H60</b> (supplied as kit comprising: sensor, fixing bracket, Ø 80 mm reflector and mounting instructions)
<b>Weight (kg)</b>	0.330

## Characteristics

<b>Product certifications</b>	CE
<b>Ambient air temperature</b>	For operation: - 25...+ 55 °C. For storage: - 40...+ 70 °C
<b>Vibration resistance</b>	Conforming to IEC 60068-2-6 7 gn, amplitude ± 1.5 mm (f = 10...55 Hz)
<b>Shock resistance</b>	Conforming to IEC 60068-2-27 30 gn, duration 11 ms
<b>Degree of protection</b>	Conforming to IEC 60529 IP 40, double insulation □
<b>Connection</b>	Screw terminals, maximum capacity: 1 x 1.5 mm <sup>2</sup>
<b>Materials</b>	Case: PEI (1)
<b>Rated supply voltage</b>	~ 24...240 V or ~ 24...48 V
<b>Voltage limits</b>	~ 20...264 V or ~ 20...60 V (including ripple)
<b>Switching capacity</b>	<b>2000 mA (cos φ = 1), 500 mA (cos φ = 0.4) for a contact life of 1 million operating cycles at an operating rate of 1 operating cycle per second, at 250 V</b>
<b>Maximum voltage on output relay contacts</b>	~ 250 V or ~ 30 V
<b>Current consumption, no-load</b>	≤ 30 mA
<b>Maximum switching frequency</b>	20 Hz
<b>Delays</b>	First-up: ≤ 60 ms; response: ≤ 25 ms; recovery: ≤ 25 ms
<b>Time delay</b>	Adjustable from 0.3 to 3 seconds

Function table	Function	Reflex system	
		No object present in the beam	Object present in the beam
Output state of relay contacts indicator: yellow LED (illuminated when relay energised)	NO	 Relay de-energised	 yellow Relay energised
		 Relay energised	 yellow

(1) PEI: high quality synthetic resin providing excellent withstand to mechanical shocks, vibration and the effects of external agents frequently encountered in industry: alcohol, salts, petroleum, oils, greases, washing agents (diluted sodium carbonate 4%, nitric acid 2%), formaldehyde vapour, splashing lactic acid, etc.

# Photo-electric sensors

OsiSense XU Application, tertiary sector series

With integral buzzer

AC or DC supply

1 NO relay output

## Detection curve

Reflex system

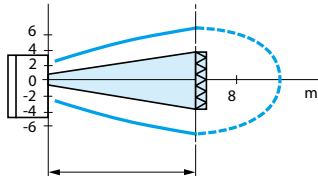

Excess gain curve (ambient temperature: + 25 °C)

Infrared reflex system

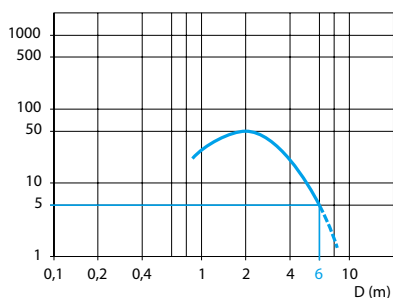

With reflector XUZC80

## Contents of kit XUJB06031H60

- reflex system photo-electric sensor,
- fixing bracket,
- Ø 80 mm reflector,
- mounting instructions.



## Dimensions

XUJB06031H60

Face view

Bracket fixing

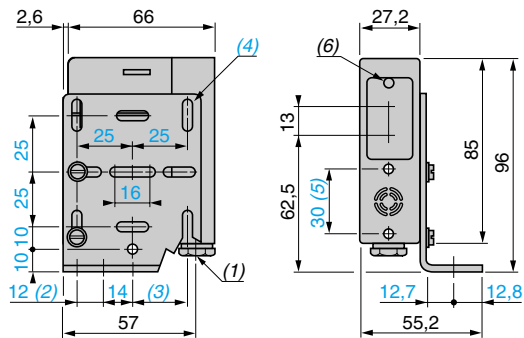

(1) 9P cable gland.

(2) 2 elongated holes Ø 6.5 x 10.

(3) 1 elongated hole Ø 6.5 x 24.

(4) 8 elongated holes Ø 4.2 x 10.

(5) Front fixing (Ø 4 screws and inserts included).

(6) Yellow LED.

(7) 2 elongated holes Ø 6.5 x 16.5.

(8) 1 elongated hole Ø 6.5 x 30.5.

## Wiring schemes (∩ or ∩∩)

NO function

Object present

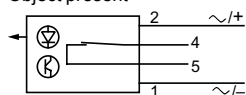

## Terminal connections

1 NO relay output

1 ∅ - A1 (∩/-)

2 ∅ - A2 (∩/+)

3 ∅ -

4 ∅ - ∩ 250 V, 100 VA max.

5 ∅ - ∩∩ 30 V, 2 A max.

# Photo-electric sensors

## OsiSense XU

### Accessories

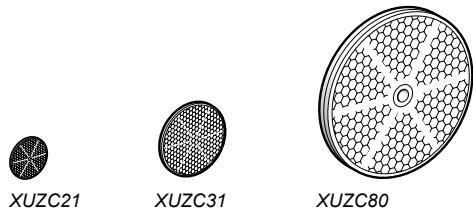

XUZC21

XUZC31

XUZC80

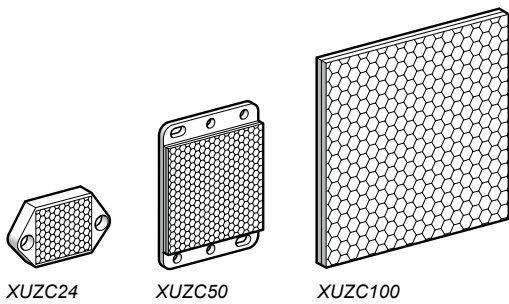

XUZC24

XUZC50

XUZC100

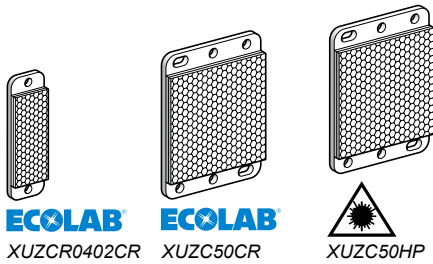

**ECOLAB**  
XUZCR0402CR

**ECOLAB**  
XUZC50CR

XUZC50HP

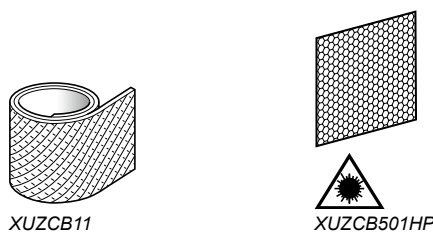

XUZCB11

XUZCB501HP

### Reflectors

Description	Dimensions mm	Fixing mode	Chemical resistance	Micro-prism (1)	Reference	Weight kg
<b>Rigid reflectors</b>						
<b>Rigid circular reflectors</b>						
	Ø 21	–	No	No	<b>XUZC16</b>	0.002
	Ø 25	–	No	No	<b>XUZC21</b>	0.002
	Ø 35	–	No	No	<b>XUZC31</b>	0.005
	Ø 46	–	No	No	<b>XUZC39</b>	0.008
	Ø 84	1 hole	No	No	<b>XUZC80</b>	0.029
<b>Rigid square reflectors</b>						
	20 x 32	2 holes	<b>Ecolab</b>	Yes	<b>XUZCR0201CRHP</b> (2)	0.004
	13 x 33	2 inserts	No	No	<b>XUZC08</b>	0.010
	23 x 40	Adhesive	No	No	<b>XUZC40S22</b>	0.015
	29 x 45	2 holes	No	No	<b>XUZC24</b>	0.007
	19 x 60	2 holes	<b>Ecolab</b>	Yes	<b>XUZCR0401CRHP</b> (2)	0.010
		2 holes	No	Yes	<b>XUZCR0401HP</b> (2)	0.010
	18 x 60	2 holes	<b>Ecolab</b>	No	<b>XUZCR0402CR</b> (2)	0.015
		2 holes	No	No	<b>XUZCR0402</b>	0.015
	30 x 82	2 holes	No	No	<b>XUZC30</b>	0.015
	50 x 70	6 holes	<b>Ecolab</b>	No	<b>XUZC50CR</b> (2)	0.020
			No	No	<b>XUZC50</b>	0.020
			No	Yes	<b>XUZC50HP</b>	0.020
	40 x 60	2 holes	No	No	<b>XUZC60S11</b>	0.022
	42 x 182	2 holes	No	No	<b>XUZC180S21</b>	0.080
	100 x 100	2 brackets	No	No	<b>XUZC100</b>	0.062

### Adhesive tape

<b>For polarized reflex sensor</b>						
	1 x 22	Adhesive	No	No	<b>XUZB11</b>	0.020
	5 x 22	Adhesive	No	No	<b>XUZB15</b>	0.085
<b>For laser sensor</b>						
	50 x 50	Adhesive	No	Yes	<b>XUZCB0501HP</b>	–
	250 x 250	Adhesive	No	Yes	<b>XUZC250</b>	–

**Note:** All reflectors are IP 67 and IP 69K. They are suitable for use at operating temperatures between - 20 °C and + 60 °C except Ecolab certified products (- 20°C...+ 140 °C).

















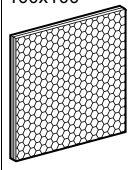







(1) Microprism: enables effective short distance detection. Used with laser beams.

(2) Operating temperature between - 20 °C and + 140 °C.

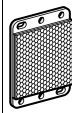
# Photo-electric sensors

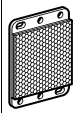
## OsiSense XU

### Accessories: sensors/reflectors table

	Blind zone	XUJC16 Ø 16	XUJC24 20x25	XUJC39 Ø 39	XUJC50 50x50	XUJC80 Ø 80	XUJC100 100x100
<b>XUB0</b> 	5 mm	 0.9 m	 1 m	 2.5 m	 3 m	 4 m	 4.5 m
<b>XUB1</b> 	10 mm	1 m	2 m	3 m	4 m	5 m	5 m
<b>XUB9</b> 	10 mm	0.6 m	0.6 m	1.4 m	2 m	4 m	4 m
<b>XUM0</b> 	10 mm	0.9 m	1.4 m	2 m	3 m	4 m	4.5 m
<b>XUM9</b> 	10 mm	1.5 m	2.5 m	3.2 m	5 m	6.5 m	6.5 m
<b>XUK0</b> 	4 cm	1 m	1 m	2.6 m	4 m	5.5 m	6.5 m
<b>XUK1</b> 	5 cm	2.5 m	4 m	7.5 m	7 m	14 m	16 m
<b>XUK9</b> 	5 cm	1.2 m	2 m	3.7 m	6 m	7.5 m	10 m
<b>XUX0</b> 	10 cm	3.5 m	5 m	8 m	15 m	21 m	22 m
<b>XUX1</b> 	10 cm	5.5 m	5.5 m	10 m	14 m	17.5 m	21 m
<b>XUX9</b> 	10 cm	4.5 m	4.5 m	8 m	11 m	13.5 m	17 m
		<b>XUZCR0402CR</b> Ecolab 16x40 	<b>XUZC50CR</b> Ecolab 50x50 	<b>XUZC50</b> 50x50 	<b>XUZCR0401CRHP</b> Ecolab Laser 16x40 	<b>XUZCB501HP</b> Tape Laser 50x50 	<b>XUZC50HP</b> Laser 50x70 
<b>XUK9S</b> 	2.1 m	3 m	6 m	–	–	–	–
<b>XU9N18</b> 	0.7 m	1 m	2 m	–	–	–	–
<b>XUK9L</b> 	–	–	–	1.8 m	6 m	12 m	–
<b>XUBTA</b> 	–	–	–	0.35 m	0.7 m	1.4 m	–

Nominal standard value given in catalogue.

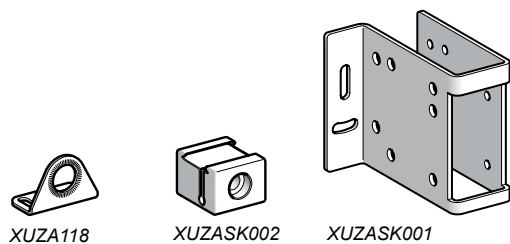

XUZA118

XUZASK002

XUZASK001

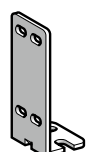

XUZA50

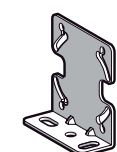

XUZA51

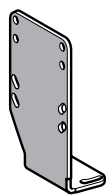

XUZASK003



XUZX2000

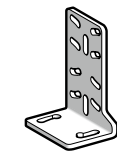

XULZ41

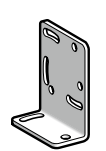

XUZA41

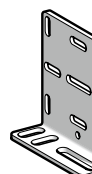

XUZA49

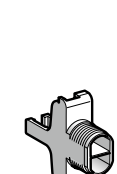

XUZASM001

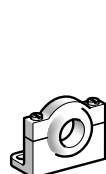

XUZA218

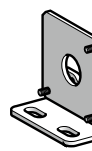

XUZA318

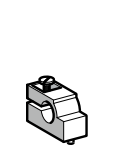

XSAZ108

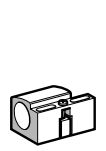

XSZB108

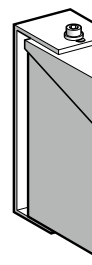

XUZZ25



XUZZ2005



XUZZ15

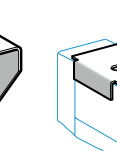

XUJZ01

## Fixing accessories

Description	For use with sensors	Reference	Weight kg
Stainless steel grade 304 fixing brackets	XUB (Ø 18)	XUZA118	0.045
	XUK●L and XUK●S	XUZASK001	0.130
Stainless steel grade 316 fixing brackets	XUB (Ø 18)	XUZASB001	0.018
	XUK●L and XUK●S	XUZA51S	0.050
Aluminium dovetail	XUK●L and XUK●S	XUZASK002	0.030
Metal fixing brackets	XUM	XUZA50	0.025
	XUK (except XUK●L and XUK●S)	XUZA51	0.050
		XUZASK003 (1)	0.060
	XUX	XUZX2000	0.065
	XUL	XULZ41	0.050
	XUJ	XUZA41	0.050
	XUJB	XUZA49	0.120
Plastic fixing bracket	XUM (except XUM0)	XUZASM001	0.010
Plastic fixing bracket with adjustable ball-joint	XU● (Ø 18 mm)	XUZA218	0.035
Precision fixing bracket with micrometric adjustment with laser transmission	XU● (Ø 18 mm)	XUZA318	0.170
Plastic fixing clamps with locking screw	XUA (Ø 8 mm)	XSAZ108	0.007
		XSZB108	0.006
	XU● (Ø 18 mm) With indexing pin	XSAZ118	0.020
	With position reference	XSZB118	0.010
	With 24.1 mm centres	XUZZ2005	0.007
Set of 2 plastic nuts	XU● (Ø 18 mm)	XSZE218	0.004
Set of 2 metal nuts	XU● (Ø 18 mm)	XSZE118	0.015
Set of 2 stainless steel nuts	XU● (Ø 18 mm)	XSZE318	0.015

## Protective covers

Description	For use with	Reference	Weight kg
Protective cover	XUK and XUJ sensors	XUZZ25	0.920
Potentiometer protective covers	XUZZC80 or XUZZC24 reflectors	XUZZ15	0.270
	XUJ sensors	XUJZ01	0.015

(1) Bracket XUZASK003 can be used to replace an XUL sensor with an XUK sensor.

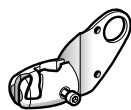

XUZB2003



XUZM2003



XUZK2003



XUZX2003



XUZM2004



XUZK2004

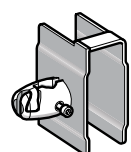

XUZX2004

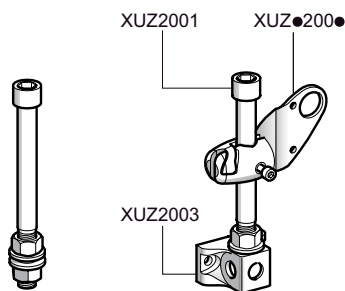

XUZ2001

3D fixing kit example



XUZ2003



XUZ2002



XURZ01

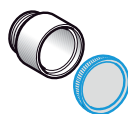

XURZ02



XUFZ08

**3D fixing kit (1)**

Description	For use with sensor type	Reference	Weight kg
Ball-joint mounted fixing bracket for mounting on M12 rod	XUB or XUZE50	XUZB2003	0.170
	XUM 0 or XUZE50	XUZM2003	0.140
	XUK or XUZE50	XUZK2003	0.170
	XUX or XUZE50	XUZX2003	0.220
Ball-joint mounted fixing bracket with protective cover for mounting on M12 rod	XUM0	XUZM2004	0.155
	XUK	XUZK2004	0.270
	XUX	XUZX2004	0.420
Support for M12 rod	–	XUZ2003	0.150
M12 rod (adjustment possible over complete height)	–	XUZ2001	0.050

(1) To obtain a 3D fixing kit, order:

- rod support **XUZ2003**

- M12 rod **XUZ2001**

- ball-joint mounted fixing bracket **XUZ●200●**

**Cabling accessories**

Description	Reference	Weight kg
Adaptor, ISO 16 - 1/2" NPT	XUZ2001	0.050
Adaptor, ISO 16 - ISO 20	XUZ2002	0.050

**Lenses**

Description	For use with	Reference	Weight kg
Lens for spot enlargement	XUR sensors	XURZ01	0.010
Lens for spot reduction	XUR sensors	XURZ02	0.015

**Spare parts**

Description	For use with	Sold in lots of	Unit reference	Weight kg
Plastic end adaptor for connecting Ø 1 mm optical fibres	Amplifiers XUDA	2	XUFZ08	0.002

**Protection fuses**

Description	For use with	Sold in lots of	Unit reference	Weight kg
Cartridge fuse 5 x 20 0.4 A "quick-blow"	Sensors without short-circuit protection	10	XUZE04	0.001
Fuse terminal block	Cartridge fuses XUZE0●	50	AB1FU10135U	0.040

#### Rigid circular reflectors

**XUZC16**

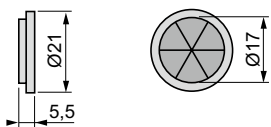

**XUZC21**

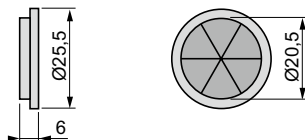

**XUZC31**

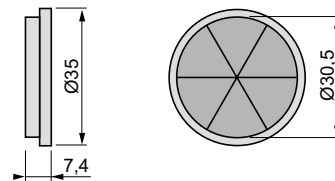

**XUZC39**

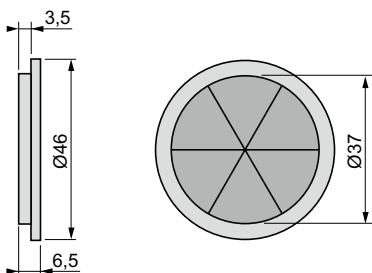

**XUZC80**

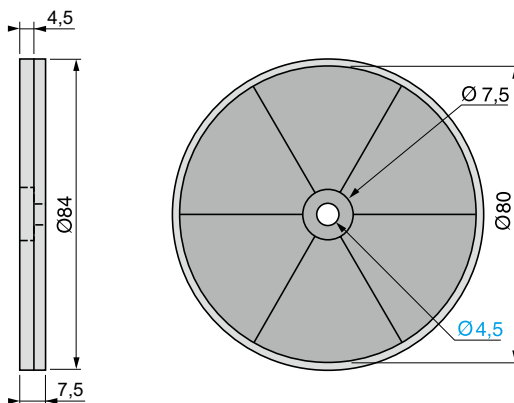

#### Rigid square reflectors

**XUZCR0201CRHP**

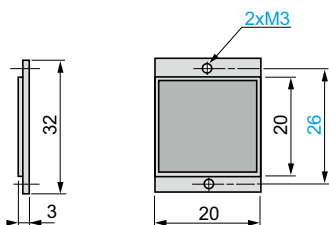

**XUZC08**

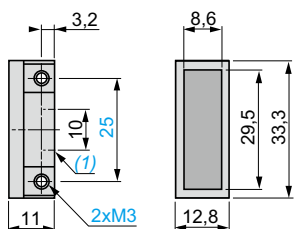

**XUZC40S22**

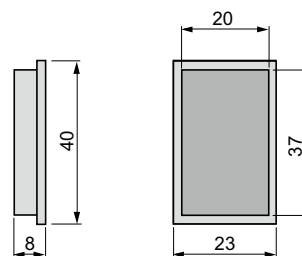

**XUZC24**

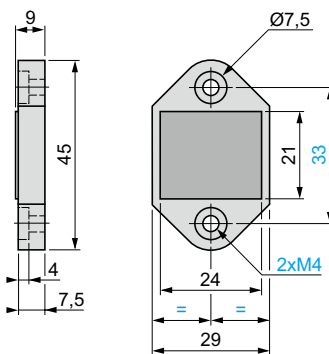

**XUZCR0401●●●●**

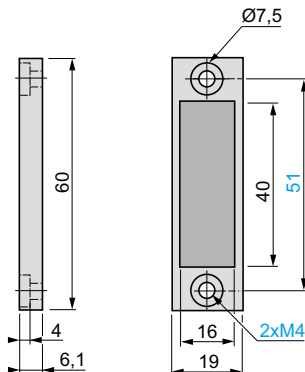

**XUZCR0402●●**

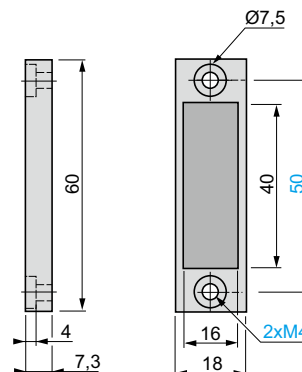



**XUZC30**

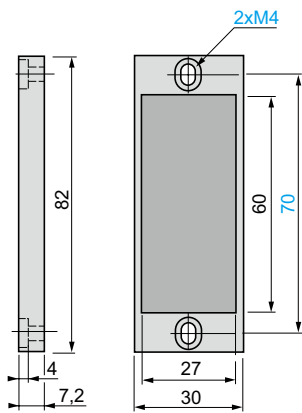

**XUZC50, XUZC50●●**

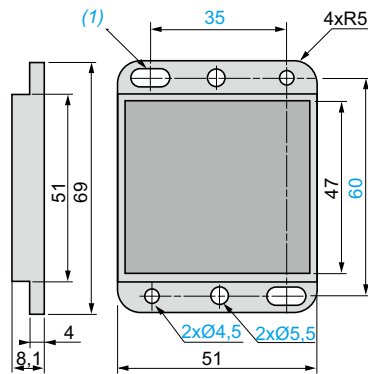

**XUZC60S11**

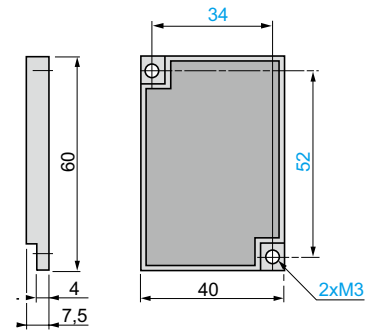

**XUZC100**

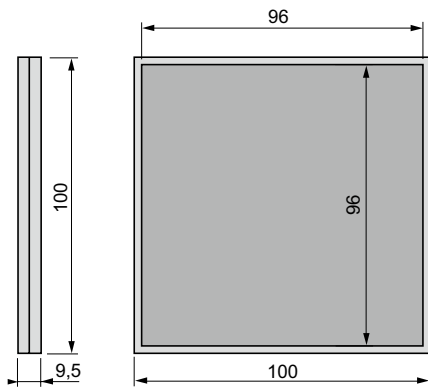

**XUZC180S21**

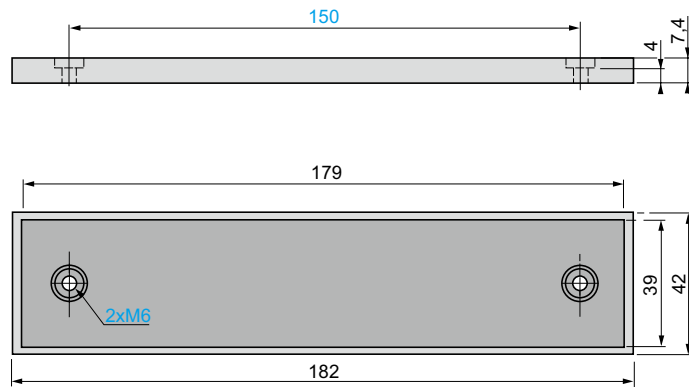

**XUZCB0501HP**

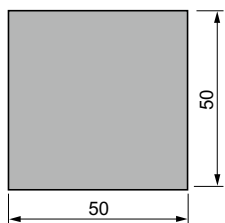

**XUZC250**

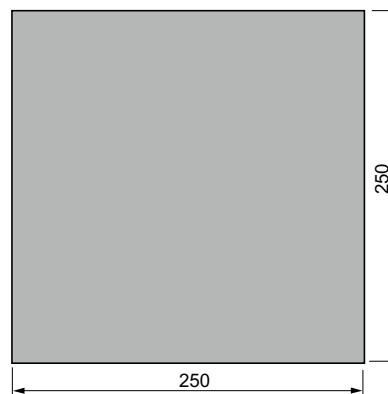

**XUZD15**

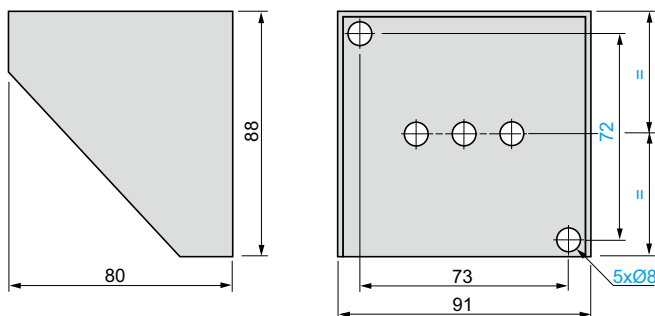

**XUZM2003 + XUZZ2001 + XUZZ2003 + XUZC50**

Mounting example

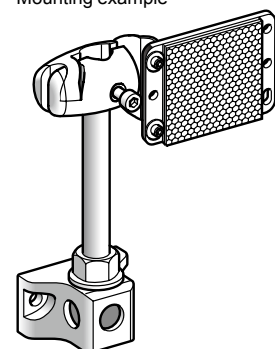

# Photo-electric sensors

## OsiSense XU

### Accessories

#### XUZA118

Fixing bracket for XUB

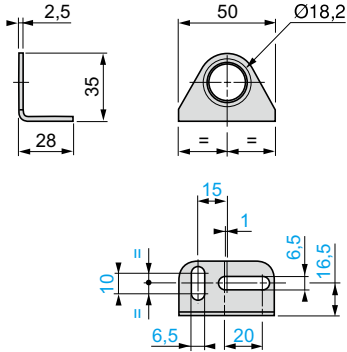

#### XUZA50

Fixing bracket for XUM (1)

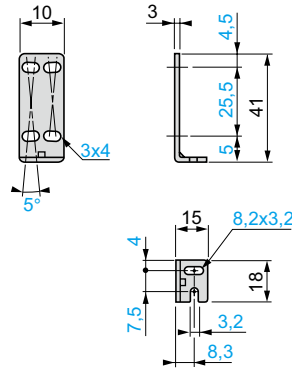

#### XUZASM001

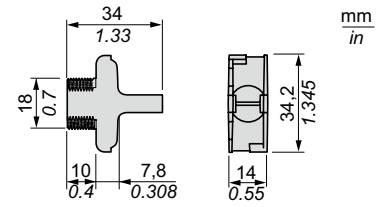

#### XUZA51

Fixing bracket for XUK (1)

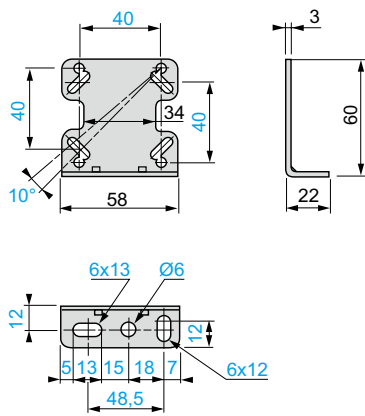

#### XUZASK003

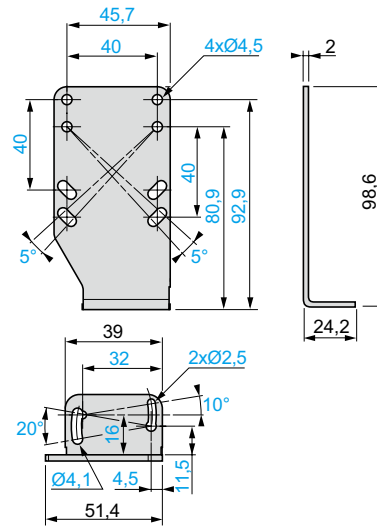

#### XUZA51S

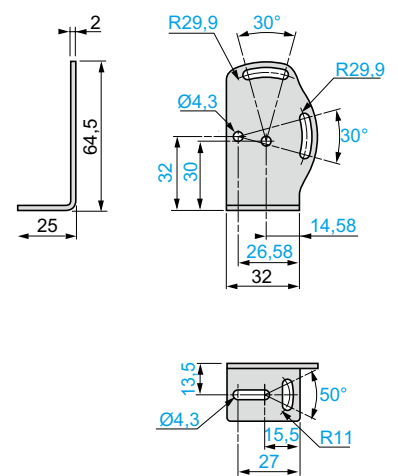

#### XUZASK001

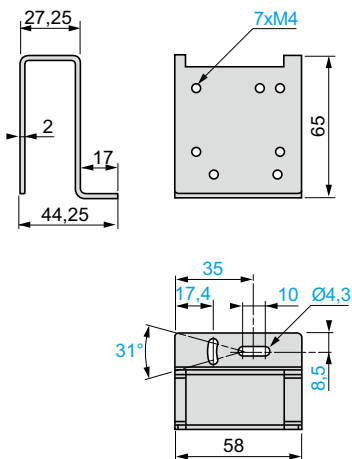

#### XUZASK002

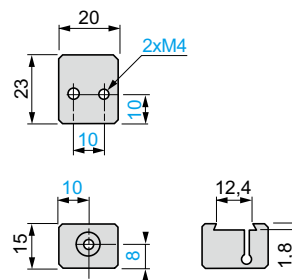

#### XUZSX2000

Fixing bracket for XUX (1)

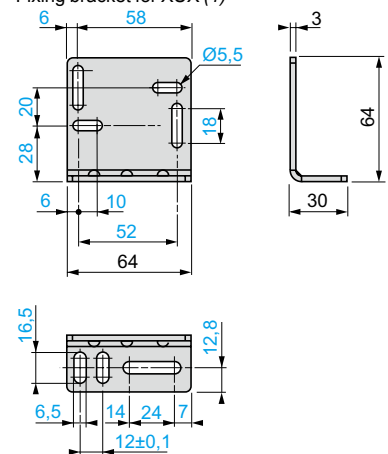

(1) Accessory fixing screws included.

#### XUZA218

Fixing bracket with adjustable ball-joint for XU● (Ø 18)

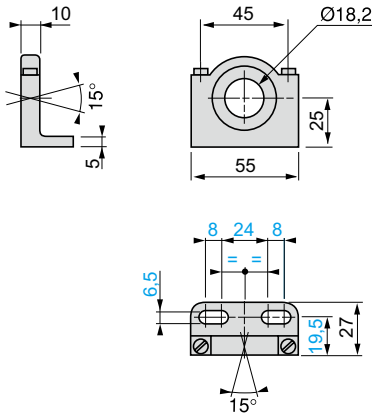

#### XUZA318

Fixing bracket with micrometric adjustment for XU2 (Ø 18) with laser transmission

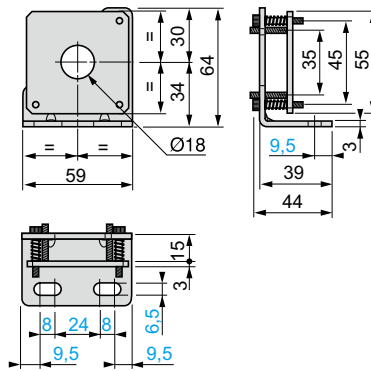

#### XUZASB001

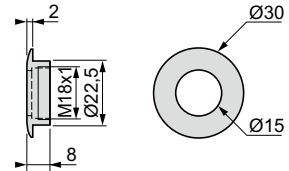

#### XSAZ1●●

Fixing clamps for XUA, XU● (Ø 18), XUF

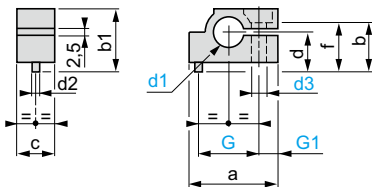

#### XSZB108, XSZB118

Fixing clamps for XUA and XU● (Ø 18)

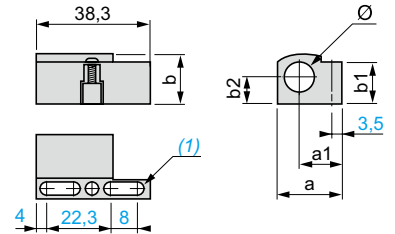

XSA	a	b	b1	c	d	Ød1	Ød2	Ød3	f	G	G1
Z108	23.5	14.2	16.7	10	8	8.1	2	4	10.5	16	5
Z118	41	30	33	17	18	18.1	3.9	6	24	30	7
Z145	23.5	14.2	16.7	10	8	4.7	2	4	10.5	16	5
Z155	23.5	14.2	16.7	10	8	5.7	2	4	10.5	16	5
Z185	23.5	14.2	16.7	10	8	8.6	2	4	10.5	16	5

XCZ	a	a1	b	b1	b2	Ø
B108	21.1	14.5	14.2	12.8	7.5	8
B118	26	15.7	22.3	20.1	11.5	18

(1) 2 elongated holes Ø 4 x 8

#### XUZB2005

Fixing clamps with 24.1 mm centres for XU● (Ø 18)

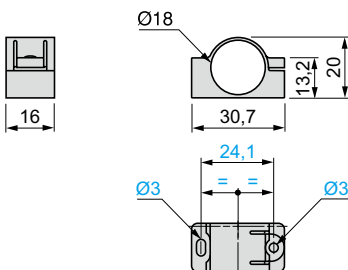

#### XUZD25

Protective cover for XUX or XUJ

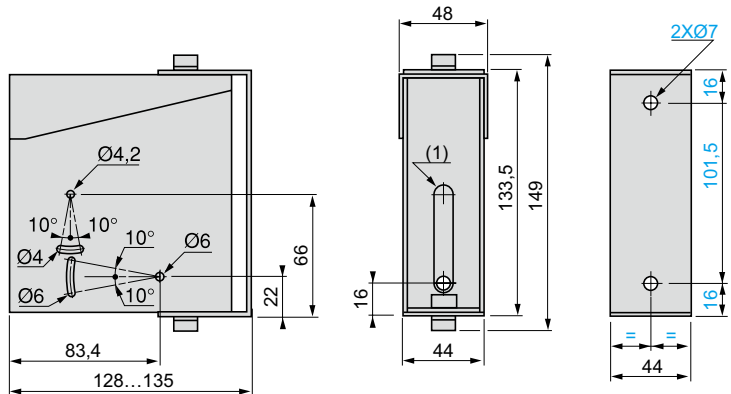

#### XUZB2003

Ball-joint mounted fixing bracket for XUB or XUJZC50

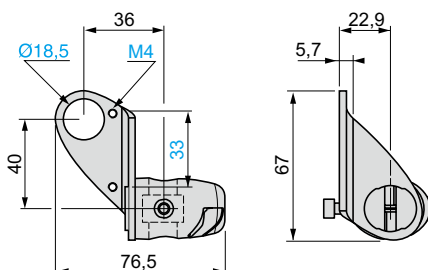

#### XUZM2003

Ball-joint mounted fixing bracket for XUM (1) or XUJZC50

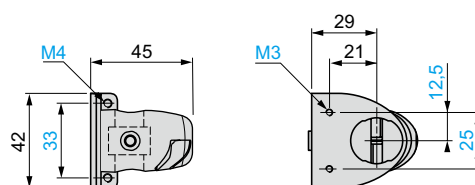

(1) Accessory fixing screws included.

#### XUZK2003

Ball-joint mounted fixing bracket for XUK (1) or XUZC50

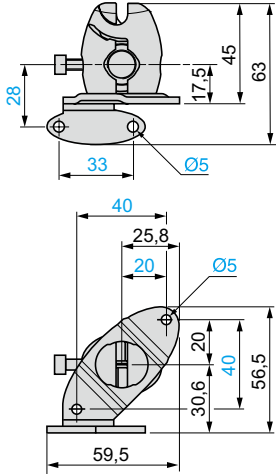

(1) Accessory fixing screws included.

#### XUZX2003

Ball-joint mounted fixing bracket for XUX (1) or XUZC50

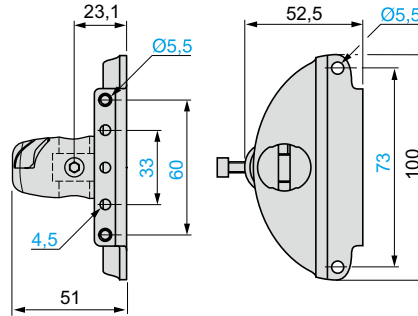

(1) Accessory fixing screws included.

#### XUZM2004

Ball-joint mounted fixing bracket with protective cover for XUM (1)

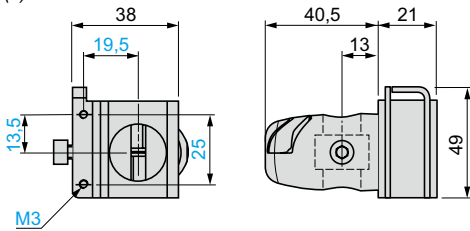

(1) Accessory fixing screws included.

#### XUZX2004

Ball-joint mounted fixing bracket with protective cover for XUX (1)

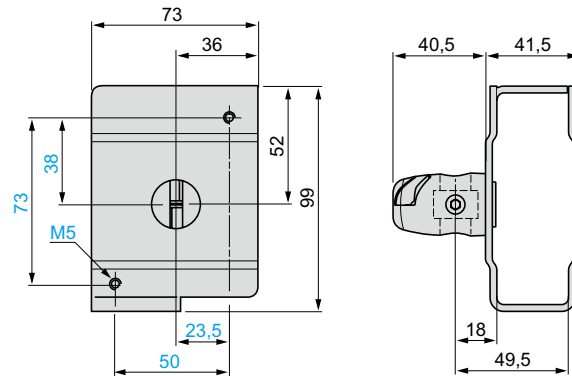

(1) Accessory fixing screws included.

#### XUZK2004

Ball-joint mounted fixing bracket with protective cover for XUK (1)

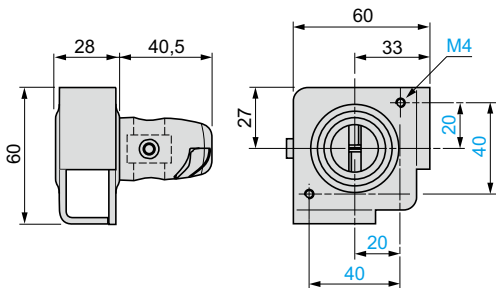

(1) Accessory fixing screws included.

#### XUZ2001

M12 rod

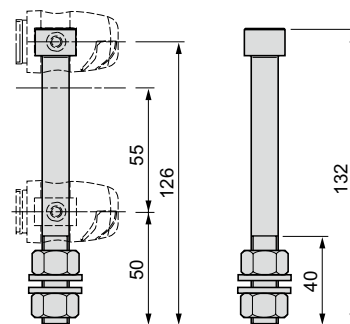

#### XUZ2003

Support for M12 rod

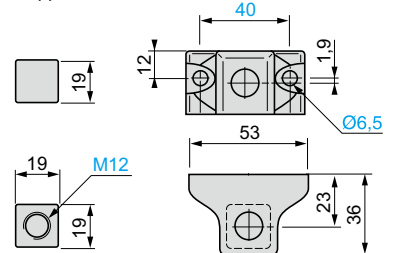

#### XUZX2001

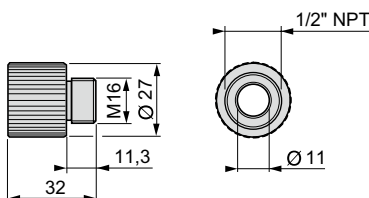

#### XUZX2002

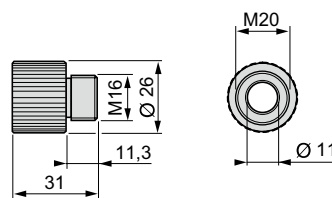

**XUZB2003 + XUZ2001 + XUZ2003**

3D fixing kit for XUB or XUZC50

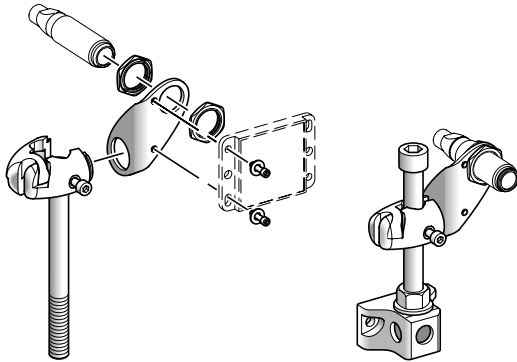

**XUZ2001 + XUZ2003**

M12 rod + rod support

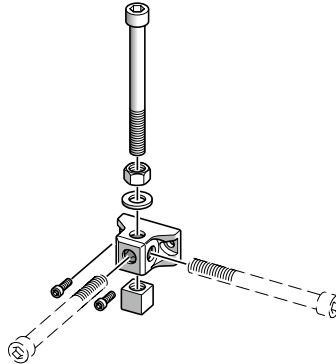

**XUZM2003 + XUZ2001**

3D fixing kit for XUM or XUZC50

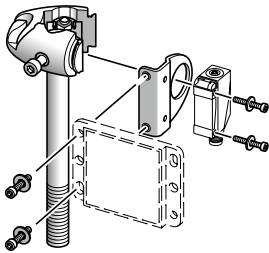

**XUZM2004 + XUZ2001**

3D fixing kit with protective cover for XUM

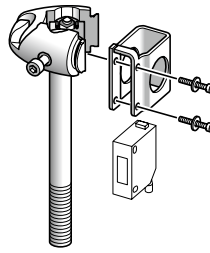

**XUZK2003 + XUZ2001**

3D fixing kit for XUK or XUZC50

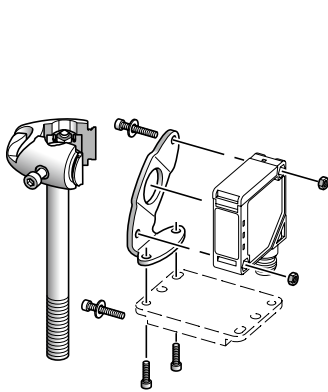

**XUZK2004 + XUZ2001 + XUZ2003**

3D fixing kit with protective cover for XUK

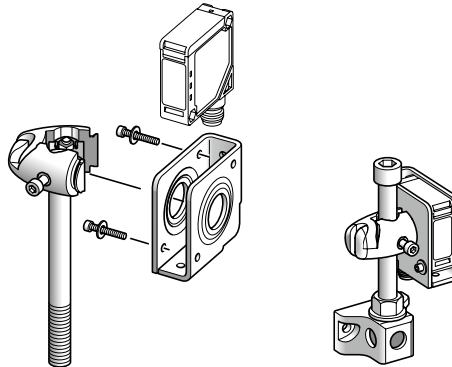

Mounting example

**XUZX2003 + XUZ2001**

3D fixing kit for XUX or XUZC50

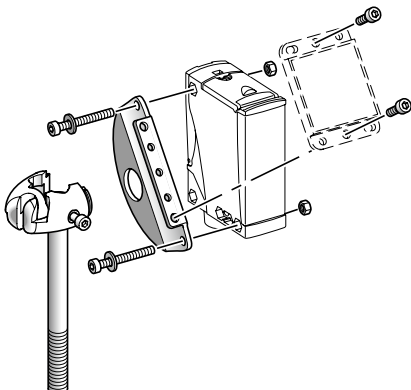

**XUZX2004 + XUZ2001**

3D fixing kit with protective cover for XUX

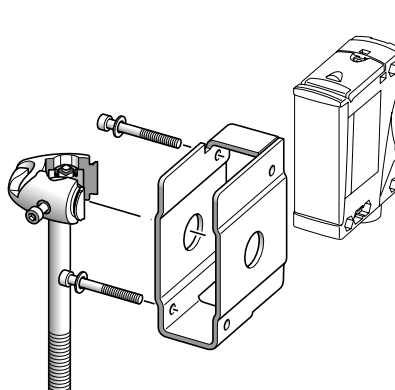

#### Sensing distance and operating margin

##### Background suppression mode

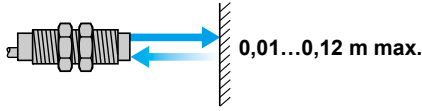

Without accessory

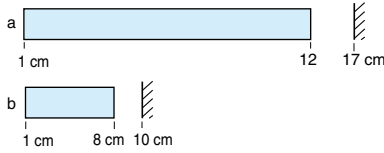

Background

a: with background teaching at maximum recommended distance.  
b: with background teaching at minimum recommended distance.

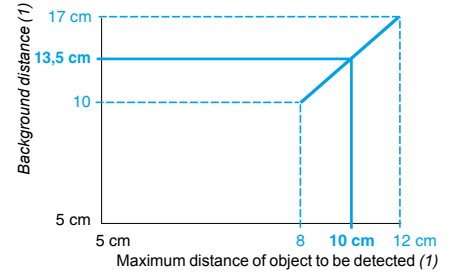

Example: teaching against a background located at 13.5 cm enables detection of an object at 1 to 10 cm.

(1) From white 90% to black 6%.

##### Diffuse mode



Without accessory

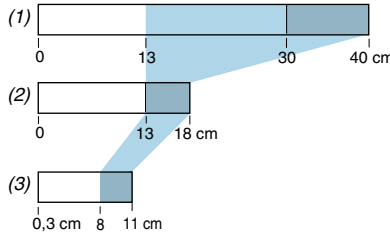

(1) White 90%. (2) Grey 18%. (3) Black 6%.

Object teaching zone

In diffuse mode, teaching of the position of the object to be detected, located between 0 and 12 cm, automatically configures the product to "background suppression" mode. This provides a constant usable sensing distance, whatever the colour of the object.

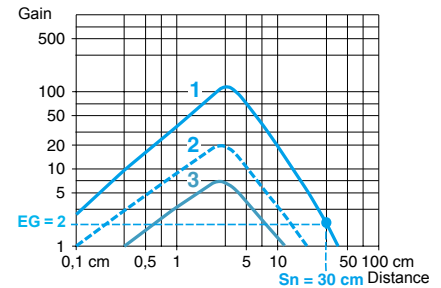

- 1 White object
- 2 Grey object
- 3 Black object

##### Polarised reflex mode

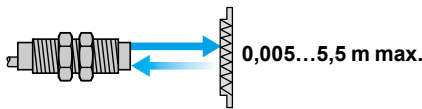

With reflector

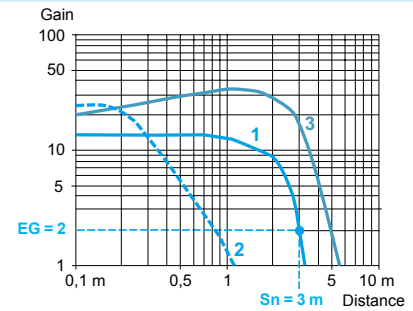
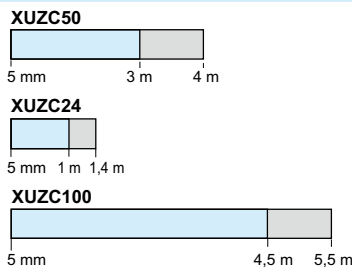

- 1 With reflector XUZC50
- 2 With reflector XUZC24
- 3 With reflector XUZC100

##### Thru-beam mode



With thru-beam accessory

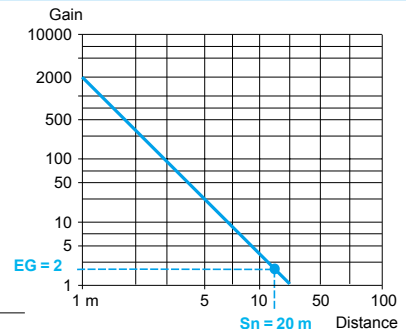

Nominal sensing distance.  $EG \geq 2$ .

Maximum sensing distance. The maximum sensing distances indicated are average values.

EG: Excess gain, operating margin.

# Photo-electric sensors

OsiSense XU, general purpose

**XUB0 Multimode function with line of sight 90° to case axis**

## Sensing distance and operating margin

### Background suppression mode

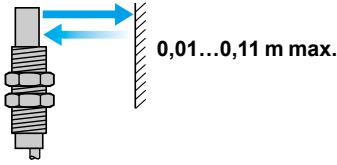

Without accessory

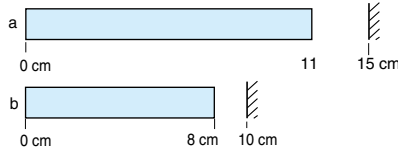

Background

a: with background teaching at maximum recommended distance.  
b: with background teaching at minimum recommended distance.

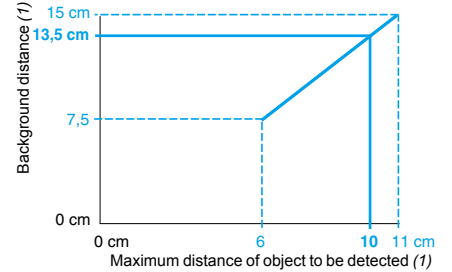

Example: teaching against a background located at 13.5 cm enables detection of an object at 0 to 10 cm.  
(1) From white 90% to black 6%.

### Diffuse mode

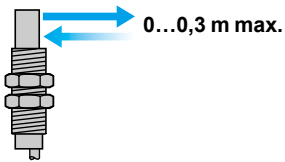

Without accessory

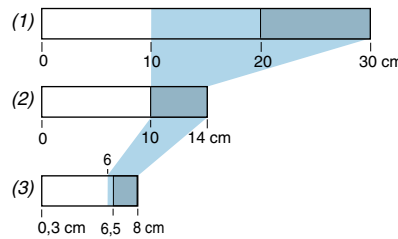

(1) White 90%. (2) Grey 18%. (3) Black 6%.

Object teaching zone

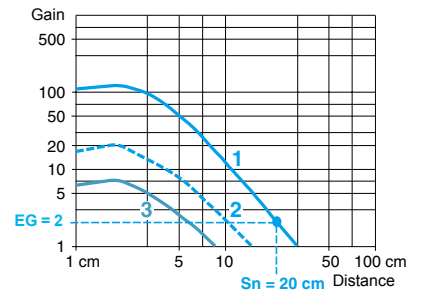

- 1 White object
- 2 Grey object
- 3 Black object

In diffuse mode, teaching of the position of the object to be detected, located between 0 and 11 cm, automatically configures the product to "background suppression" mode. This provides a constant usable sensing distance, whatever the colour of the object.

### Polarised reflex mode

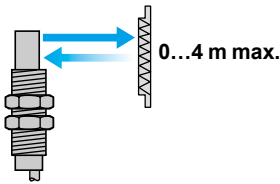

With reflector

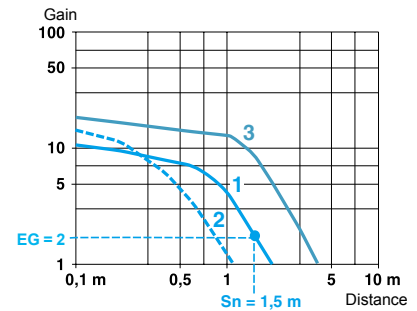
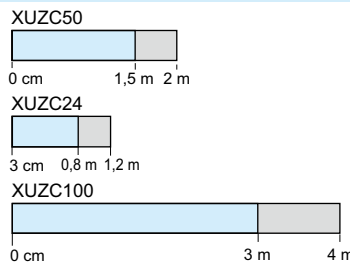

- 1 With reflector XUZC50
- 2 With reflector XUZC24
- 3 With reflector XUZC100

### Thru-beam mode

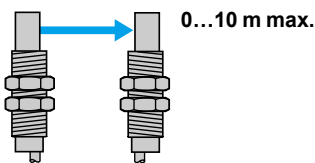

With thru-beam accessory

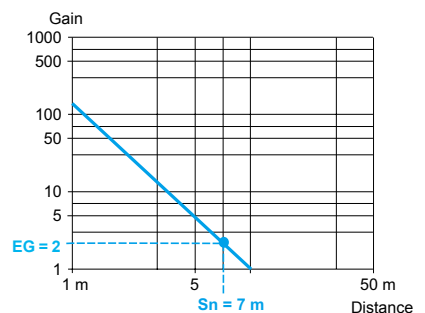
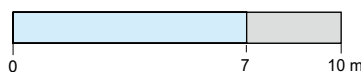

Nominal sensing distance.  $EG \geq 2$ .

Maximum sensing distance. The maximum sensing distances indicated are average values.

EG: Excess gain, operating margin.

# Photo-electric sensors

OsiSense XU, general purpose, single mode function

**XUB●●●●●** with line of sight along or at 90° to case axis

## Sensing distance and operating margin

### Diffuse sensor XUB4●●●●● with line of sight along case axis

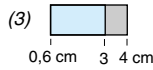
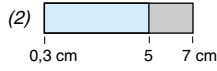
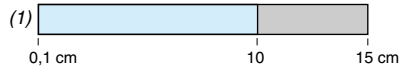

(1) White 90%. (2) Grey 18%. (3) Black 6%.

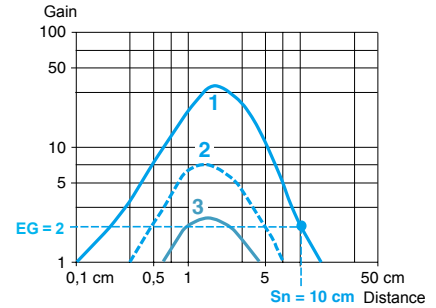

- 1 White object
- 2 Grey object
- 3 Black object

### Diffuse sensor XUB4●●●●● with line of sight 90° to case axis

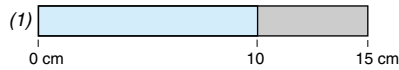
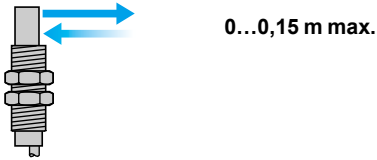

(1) White 90%. (2) Grey 18%. (3) Black 6%.

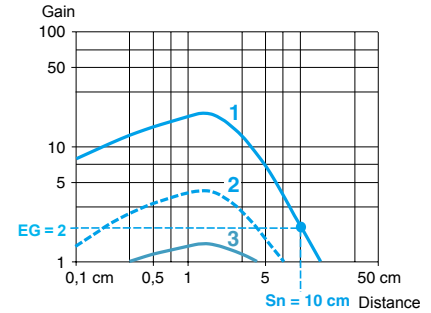

- 1 White object
- 2 Grey object
- 3 Black object

### Diffuse sensor XUB5●●●●● with line of sight along or at 90° to case axis

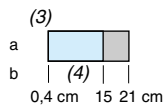
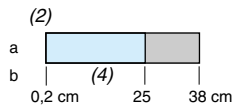
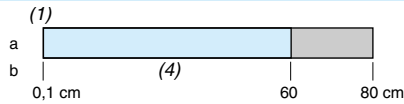

(1) White 90%. (2) Grey 18%. (3) Black 6%.  
(4) No detection.

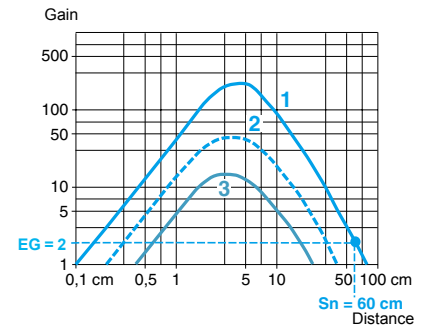

- 1 White object
- 2 Grey object
- 3 Black object

Light blue box: Nominal sensing distance.  $EG \geq 2$ .  
Grey box: Maximum sensing distance. The maximum sensing distances indicated are average values.

EG: Excess gain, operating margin.  
a: Potentiometer set at maximum.  
b: Potentiometer set at minimum.



# Photo-electric sensors

OsiSense XU, general purpose, single mode function

**XUB●●●●●** with line of sight along or at 90° to case axis

## Sensing distance and operating margin

### Polarised reflex sensor XUB9●●●●● with line of sight along or at 90° to case axis

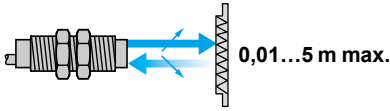

With reflector

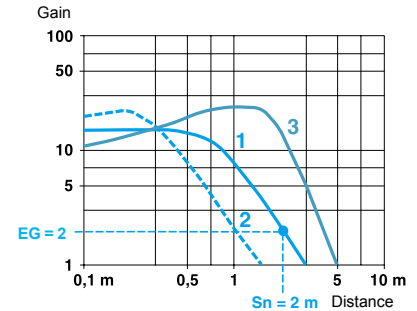
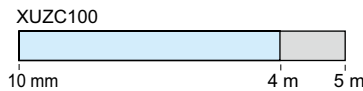
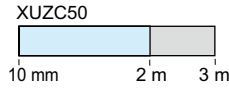

- 1 With reflector XUZ C50
- 2 With reflector XUZ C24
- 3 With reflector XUZ C100

### Reflex sensor XUB1●●●●● with line of sight along or at 90° to case axis

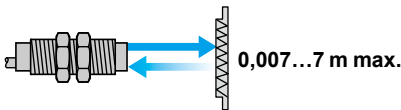

With reflector

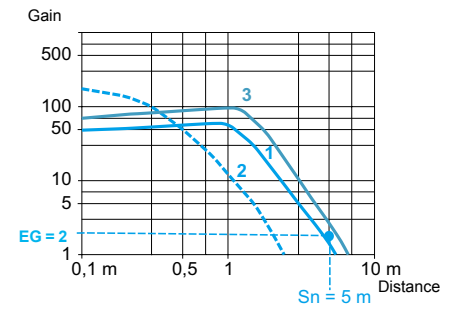
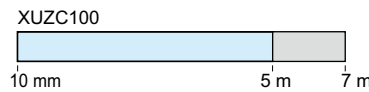
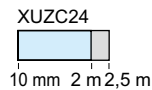
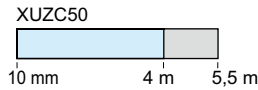

- 1 With reflector XUZC50
- 2 With reflector XUZC24
- 3 With reflector XUZC100

### Thru-beam sensor XUB2●●●●● with line of sight along or at 90° to case axis

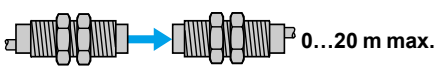

With thru-beam accessory

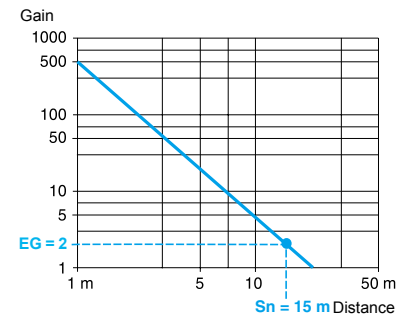
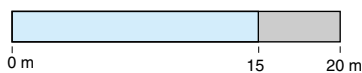

Nominal sensing distance.  $EG \geq 2$ .

Maximum sensing distance. The maximum sensing distances indicated are average values.

EG: Excess gain, operating margin.

# Photo-electric sensors

OsiSense XU, general purpose  
**XUMO** multimode function

## Sensing distance and operating margin

### Background suppression mode

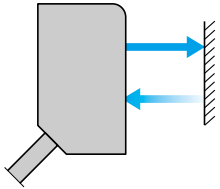

0...0,11 m max.

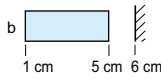
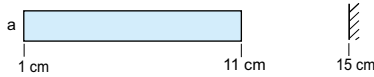

Background

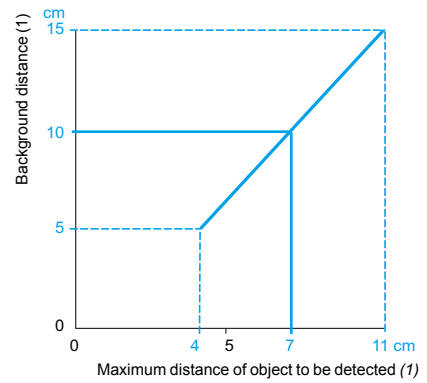

Example: teaching against a background located at 10 cm enables detection of an object at 1 to 7 cm.

(1) From white 90% to black 6%.

Without accessory

a: with background teaching at maximum recommended distance.  
 b: with background teaching at minimum recommended distance.

### Diffuse mode

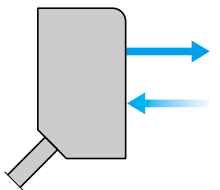

0...0,55 m max.

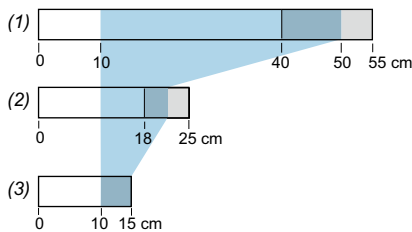

(1) White 90%. (2) Grey 18%. (3) Black 6%.

Object teaching zone

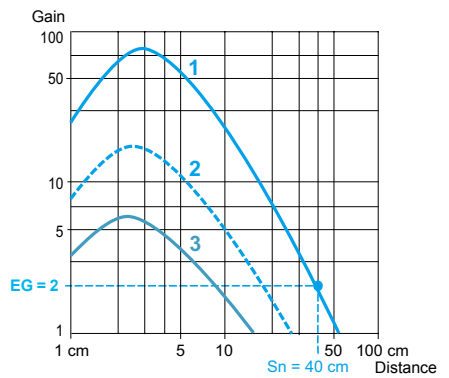

- 1 White object
- 2 Grey object
- 3 Black object

In diffuse mode, teaching of the position of the object to be detected, located between 0 and 10 cm, automatically configures the product to "background suppression" mode. This provides a constant usable sensing distance, whatever the colour of the object.

Nominal sensing distance.  $EG \geq 2$ .  
 Maximum sensing distance. The maximum sensing distances indicated are average values.

EG: Excess gain, operating margin.

## Sensing distance and operating margin (continued)

### Polarised reflex mode

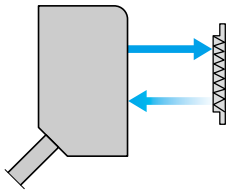

0,01...6,5 m max.

**XUZC50**



**XUZC24**

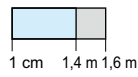

**XUZC100**

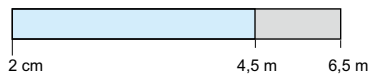

With reflector

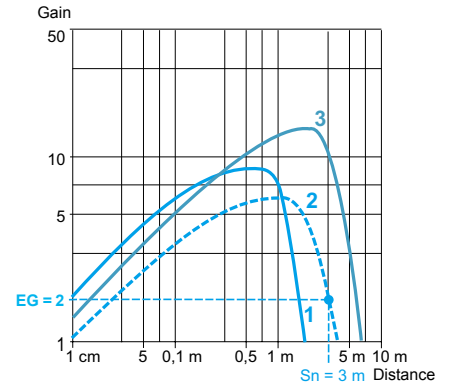

- 1 With reflector XUZC50
- 2 With reflector XUZC24
- 3 With reflector XUZC100

### Thru-beam mode

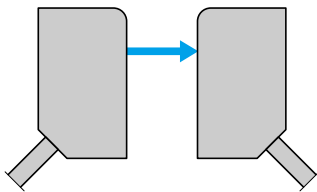

0...14 m max.

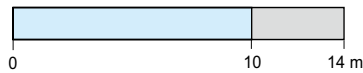

With thru-beam accessory

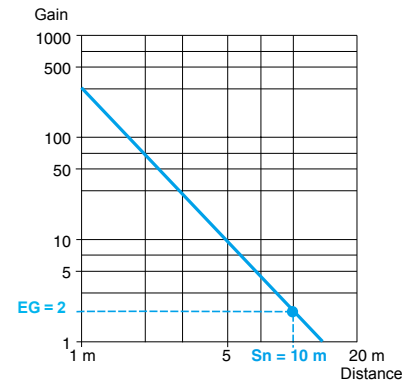

Nominal sensing distance.  $EG \geq 2$ .  
 Maximum sensing distance. The maximum sensing distances indicated are average values.

EG: Excess gain, operating margin.

### Sensing distance and operating margin

#### Background suppression mode

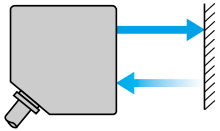

0...28 cm max.

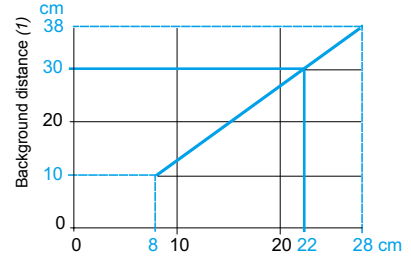
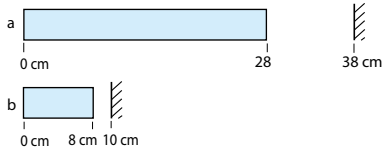

Example: teaching against a background located at 30 cm enables detection of an object at 0 to 22 cm.

(1) From white 90% to black 6%.

Without accessory

Background

a: with background teaching at maximum recommended distance.  
b: with background teaching at minimum recommended distance.

#### Diffuse mode

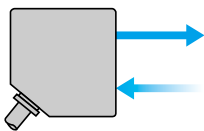

0...1,2 m max.

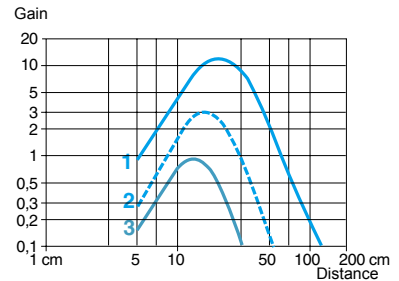
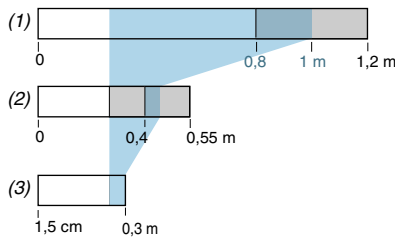

Without accessory

(1) White 90%. (2) Grey 18%. (3) Black 6%.

Object teaching zone

- 1 White object
- 2 Grey object
- 3 Black object

In diffuse mode, teaching of the position of the object to be detected, located between 0 and 0.3 m, automatically configures the product to "background suppression" mode. This provides a constant usable sensing distance, whatever the colour of the object.

#### Polarised reflex mode

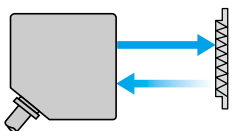

0,04...8 m max.

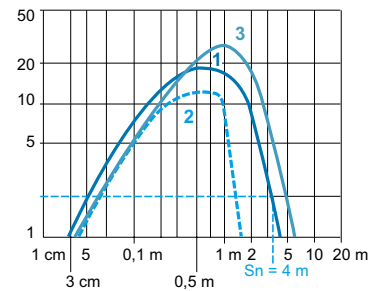
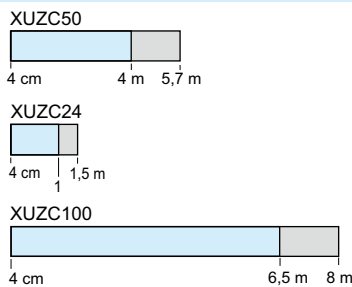

With reflector

- 1 With reflector XUZC50
- 2 With reflector XUZC24
- 3 With reflector XUZC100

#### Thru-beam mode

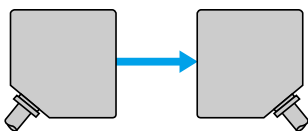

0...45 m max.

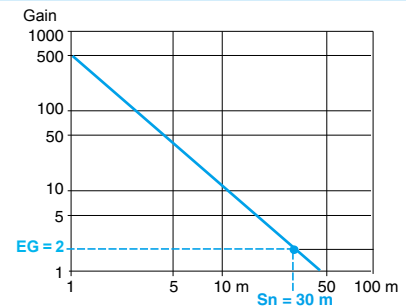
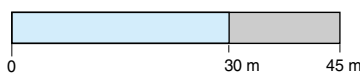

With thru-beam accessory

Light blue bar: Nominal sensing distance.  $EG \geq 2$ .  
Grey bar: Maximum sensing distance. The maximum sensing distances indicated are average values.  
EG: Excess gain, operating margin.

### Sensing distance and operating margin

#### Diffuse sensor XUK5A●●●

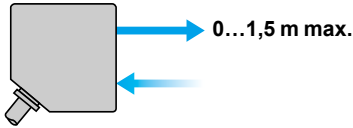

Without accessory

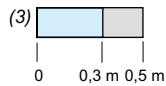
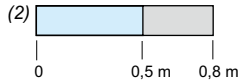
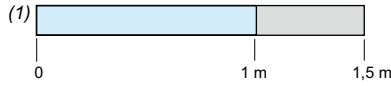

- (1) White 90%.
- (2) Grey 18%.
- (3) Black 6%.

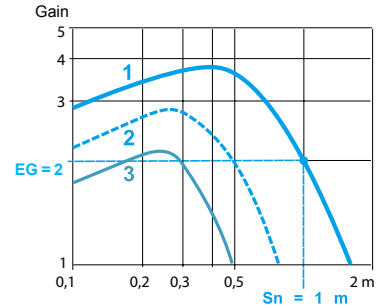

- 1 White object
- 2 Grey object
- 3 Black object

#### Polarised reflex sensor XUK9A●●●

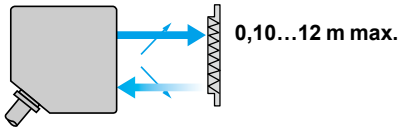

With reflector

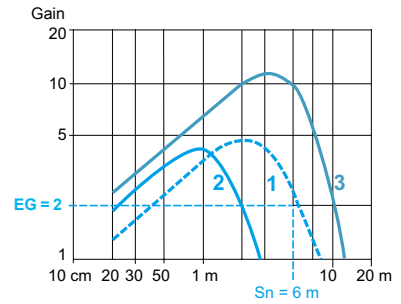
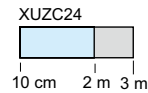
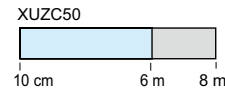

- 1 With reflector XUZC50
- 2 With reflector XUZC24
- 3 With reflector XUZC100

#### Reflex sensor XUK1A●●●

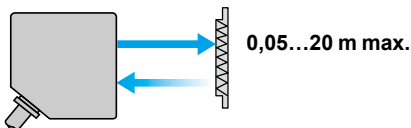

With reflector

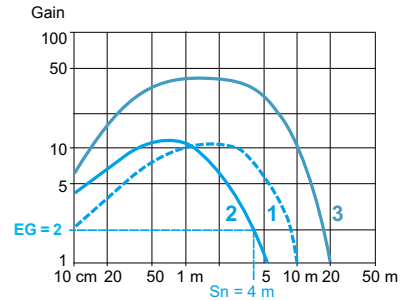
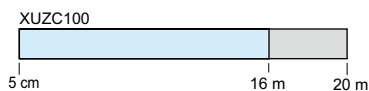
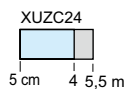
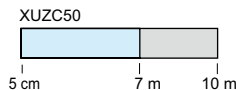

- 1 With reflector XUZC50
- 2 With reflector XUZC24
- 3 With reflector XUZC100

#### Thru-beam sensor XUK2A●●●

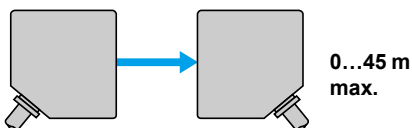

With thru-beam accessory

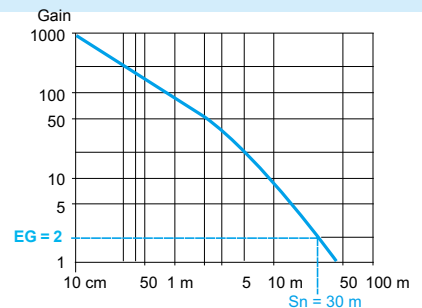
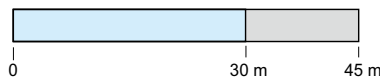

Nominal sensing distance.  $EG \geq 2$ .

Maximum sensing distance. The maximum sensing distances indicated are average values.

EG: Excess gain, operating margin.

# Photo-electric sensors

## OsiSense XU, general purpose

### Multimode function

#### XUX0●●●

### Sensing distance and operating margin

#### Background suppression mode

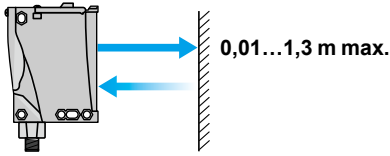

Without accessory

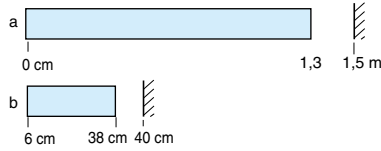

Background

a: with background teaching at maximum recommended distance.  
 b: with background teaching at minimum recommended distance.

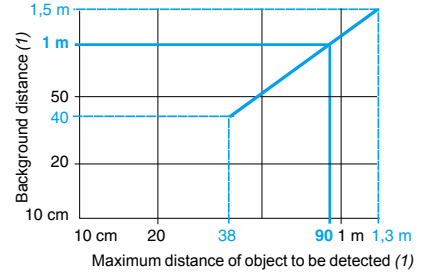

Example: teaching against a background located at 1 m enables detection of an object at 0 to 90 cm.

(1) From white 90% to black 6%.

#### Diffuse mode

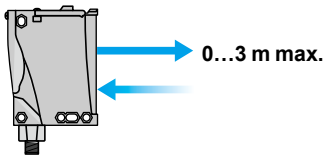

Without accessory

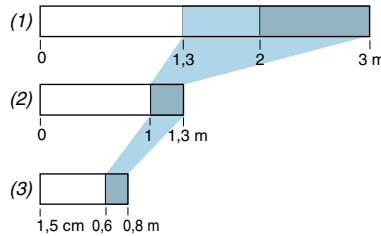

(1) White 90%. (2) Grey 18%. (3) Black 6%.

Object teaching zone

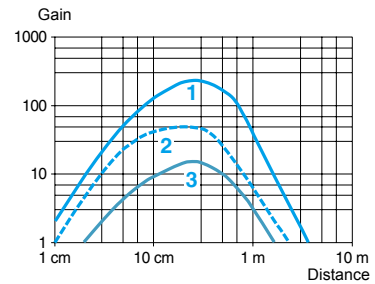

- 1 White object
- 2 Grey object
- 3 Black object

In diffuse mode, teaching of the position of the object to be detected, located between 0 and 1.3 m, automatically configures the product to "background suppression" mode. This provides a constant usable sensing distance, whatever the colour of the object.

#### Polarised reflex mode

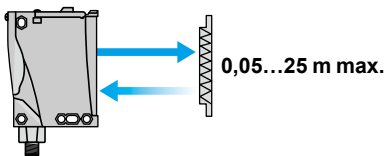

With reflector

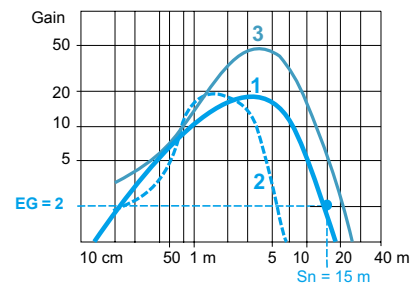
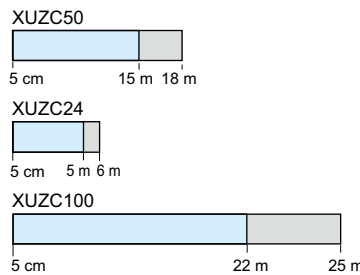

- 1 With reflector XUZC50
- 2 With reflector XUZC24
- 3 With reflector XUZC100

#### Thru-beam mode

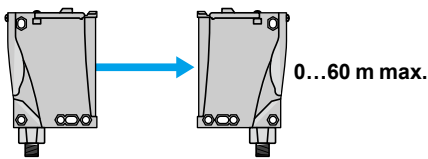

With thru-beam accessory

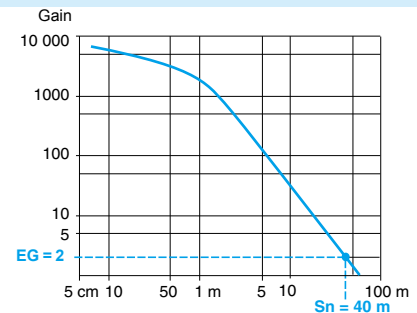
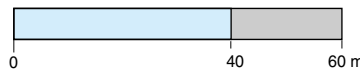

Nominal sensing distance.  $EG \geq 2$ .

Maximum sensing distance. The maximum sensing distances indicated are average values.

EG: Excess gain, operating margin.

# Photo-electric sensors

OsiSense XU, general purpose  
Single mode function  
XUX●A●●●●

## Sensing distance and operating margin

### Diffuse sensor XUX5A●●●●●●

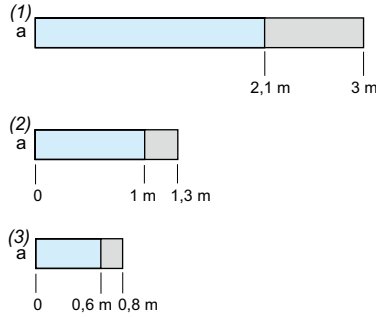
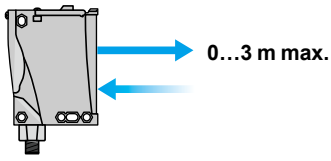

(1) White 90%. (2) Grey 18%. (3) Black 6%.

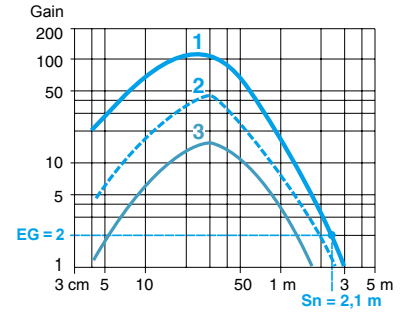

- 1 White object
- 2 Grey object
- 3 Black object

### Polarised reflex sensor XUX9A●●●●●●

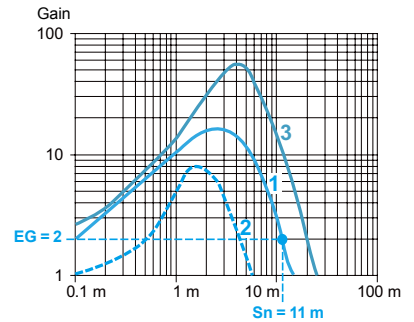
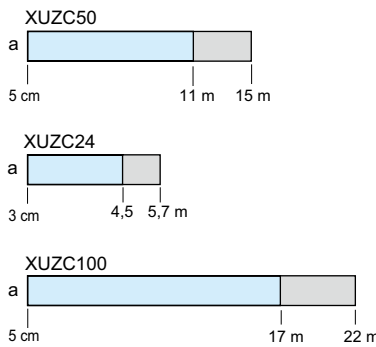
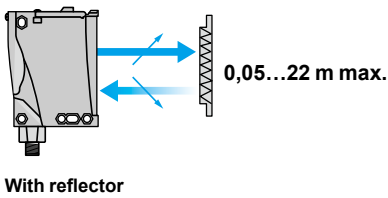

- 1 With reflector XUZC50
- 2 With reflector XUZC24
- 3 With reflector XUZC100

### Reflex sensor XUX1A●●●●●●

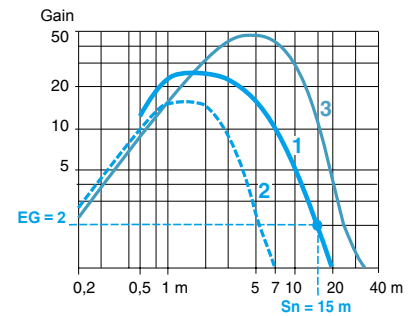
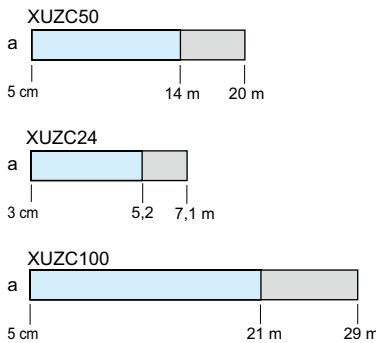
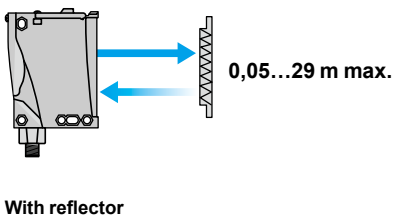

- 1 With reflector XUZC50
- 2 With reflector XUZC24
- 3 With reflector XUZC100

### Thru-beam sensor XUX2A●●●●●●

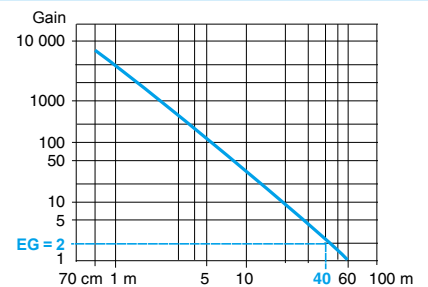
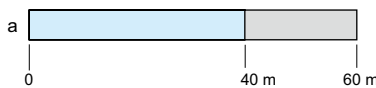
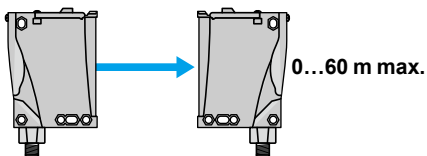

Nominal sensing distance. EG ≥ 2.

Maximum sensing distance. The maximum sensing distances indicated are average values.

a: Potentiometer set at maximum.

EG: Excess gain, operating margin.

<b>A</b>							
AB1FU10135U	165	XU8M18MB230	156	XUB0SPSNM12	92	XUFN5P01L2	137
		XU8M18MB230K	156	XUB0SPSWL2	92	XUFN5P01L10	137
		XU8M18MB230W	156	XUB0SPSWM12	92	XUFN5S01L2	137
<b>X</b>		XU8M18MB230WK	156	XUB1AN●●M12	28	XUFN5S01L10	137
XSAZ108	102	XU9M18MA230	156	XUB1AP●●M12	28	XUFN01321	137
	164	XU9M18MA230K	156	XUB1BN●●M12	30	XUFN01331	137
XSAZ118	164	XU9M18MA230W	156	XUB1BP●●M12	30	XUFN02323	137
XSZB108	102	XU9M18MA230WK	156	XUB2AKS●M12T	28	XUFN04331	137
	164	XU9M18MB230	156	XUB2A●●●M12R	28	XUFN05321	136
XSZ●118	164	XU9M18MB230K	156	XUB2BKS●M12T	30	XUFN05321L10	136
XSZE●18	94	XU9M18MB230W	156	XUB2BN●●M12R	30	XUFN05323	136
	164	XU9M18MB230WK	156	XUB2BP●●M12R	30	XUFN05331	136
XSZMCR03	91	XU9N18NP341	94	XUB4AN●●M12	28	XUFN12301	134
XSZMCR10	91	XU9N18NP341D	94	XUB4AP●●M12	28	XUFN12301L10	134
XU1N18NP341	94	XU9N18NP341D	94	XUB4BN●●M12	30	XUFN12311	134
XU1N18NP341D	94	XU9N18NP341WD	94	XUB4BP●●M12	30	XUFN35301	134
XU1N18NP341W	94	XU9N18PP341	94	XUB5AN●●M12	28	XUFN35311	135
XU1N18NP341WD	94	XU9N18PP341D	94	XUB5AP●●M12	28	XUFS●●20	138
XU1N18PP341	94	XU9N18PP341W	94	XUB5BN●●M12	30	XUFZ0●	140
XU1N18PP341D	94	XU9N18PP341WD	94	XUB5BP●●M12	30	XUFZ08	140
XU1N18PP341W	94	XUAH02●●	102	XUB9AN●●M12	28		165
XU1N18PP341WD	94	XUAH02●●S	102	XUB9AP●●M12	28	XUFZ1●	140
XU2M18AP20D	124	XUAH05●5	102	XUB9BN●●M12	30	XUFZ210	140
XU2M18MA230	156	XUAH05●5S	102	XUB9BP●●M12	30	XUFZ310	140
XU2M18MA230K	156	XUAJ02●●	102	XUBLAKCNL2T	116	XUFZ910	139
XU2M18MA230W	156	XUAJ02●●S	102	XUBLAKCNM12T	116	XUFZ911	139
XU2M18MA230WK	156	XUAJ05●●	102	XUBLANCNL2	116	XUFZ920	139
XU2M18MB230	156	XUAJ05●●S	102	XUBLANCNL2R	116	XUFZ921	139
XU2M18MB230K	156	XUB0AKSNL2T	32	XUBLANCNM12	116	XUJB06031H60	160
XU2M18MB230W	156	XUB0AKSNM12T	32	XUBLANCNM12R	116	XUJK803538	118
XU2M18MB230WK	156	XUB0AKSWL2T	32	XUBLAPCNL2	116	XUJZ01	164
XU2N18NP341	94	XUB0AKSWM12T	32	XUBLAPCNL2R	116	XUK0AKSAL2	44
XU2N18NP341D	94	XUB0ANSNL2	32	XUBLAPCNM12	116	XUK0AKSAL2T	44
XU2N18NP341W	94	XUB0ANSNM12	32	XUBLAPCNM12R	116	XUK0AKSAM12	44
XU2N18NP341WD	94	XUB0ANSWL2	32	XUBLBKCNL2T	116	XUK0AKSAM12T	44
XU2N18PP341	94	XUB0ANSWM12	32	XUBLBKCNM12T	116	XUK0ARCTL2	44
XU2N18PP341D	94	XUB0APSNL2	32	XUBLBNCNL2	116	XUK0ARCTL2T	44
XU2N18PP341W	94	XUB0APSNM12	32	XUBLBNCNL2R	116	XUK1AN●NL2	42
XU2N18PP341WD	94	XUB0APSWL2	32	XUBLBNCNM12	116	XUK1AN●NM12	42
XU5M18AB20D	120	XUB0APSWM12	32	XUBLBNCNM12R	116	XUK1AP●NL2	42
XU5M18MA230	156	XUB0BKSNL2T	32	XUBLBPCNL2	116	XUK1AP●NM12	42
XU5M18MA230K	156	XUB0BKSNM12T	32	XUBLBPCNL2R	116	XUK1ARCNL2	42
XU5M18MA230W	156	XUB0BKSWL2T	32	XUBLBPCNM12	116	XUK1ARCNL2H6●	158
XU5M18MA230WK	156	XUB0BKSWM12T	32	XUBLBPCNM12R	116	XUK2AKSNL2T	42
XU5M18MB230	156	XUB0BNSNL2	32	XUBT1●SNL2	84	XUK2AKSNM12T	42
XU5M18MB230K	156	XUB0BNSNM12	32	XUBT1●SNM12	84	XUK2A●●NL2R	42
XU5M18MB230W	156	XUB0BNSWL2	32	XUBTANS●L2	84	XUK2A●●NM12R	42
XU5M18MB230WK	156	XUB0BNSWM12	32	XUBTANS●M12	84	XUK2ARCNL2T	42
XU5M18U1D	80	XUB0BPSNL2	32	XUBTAPS●L2	84	XUK2LAKSMM12T	108
XU5N18NP341	94	XUB0BPSNM12	32	XUBTAPS●M12	84	XUK2LAPSMM12R	108
XU5N18NP341D	94	XUB0BPSWL2	32	XUBTSENS●L2	84	XUK2SKSMM12T	98
XU5N18NP341W	94	XUB0BPSWM12	32	XUBTSENS●M12	84	XUK2SPSMM12R	98
XU5N18NP341WD	94	XUB0SKSNL2T	92	XUBTSPS●L2	84	XUK5AN●NL2	42
XU5N18PP341	94	XUB0SKSNM12T	92	XUBTSPS●M12	84	XUK5AN●NM12	42
XU5N18PP341D	94	XUB0SKSWL2T	92	XUDA1●SML2	132	XUK5AP●NL2	42
XU5N18PP341W	94	XUB0SKSWM12T	92	XUDA1●SMM8	132	XUK5AP●NM12	42
XU5N18PP341WD	94	XUB0SNSNL2	92	XUDA2●SML2	132	XUK5ARCNL2	42
XU8M18MA230	156	XUB0SNSNM12	92	XUDA2●SMM8	132	XUK5LAPSMM12	108
XU8M18MA230K	156	XUB0SNSWL2	92	XUE●AA2NM12	122	XUK8AKSNL2	46
XU8M18MA230W	156	XUB0SNSWM12	92	XUFN2●01L2	135	XUK8AKSNM12	46
XU8M18MA230WK	156	XUB0SPSNL2	92	XUFN2●01L10	135	XUK8ARCTL2	48
						XUK8LAPPNM12	108
						XUK8SPSMM12	98
						XUK9A●●NL2	42
						XUK9A●●NM12	42
						XUK9ARCNL2	42
						XUK9LAPSMM12	108
						XUK9SPSMM12	98
						XUKC1●SMM12	90
						XUKR1●SMM12	74
						XUKT1KSML2	88
						XUKT1KSMM12	88
						XULA060●1	152
						XULA060●1K	152
						XULA040●19	152
						XULA040●19K	152
						XULA700●15	152
						XULA700●15K	152
						XULZ41	164
						XUM0AKSAL2T	38
						XUM0AKSAM8T	38
						XUM0A●SAL2	38
						XUM0A●SAM8	38
						XUM2AKCN●T	34
						XUM2A●CNL2	34
						XUM2A●CNL2R	34
						XUM2A●CNM8	34
						XUM2A●CNM8R	34
						XUM5A●CNL2	34
						XUM5A●CNM8	34
						XUM8A●CNL2	40
						XUM8ANCNM8	40
						XUM8APCNL03M12	40
						XUM8APCNM8	40
						XUM9A●CNL2	34
						XUM9A●CNM8	34
						XUMTA●CNL2	86
						XUMTA●CNM8	86
						XUMTAPCNL03M12	86
						XURK1KSMM12	78
						XURZ0●	165
						XUVA0505PANM8	56
						XUV●0312	70
						XUVK0252S	66
						XUVK0252VS	66
						XUX0AKSAM12	52
						XUX0AKSAM12T	50
							52
						XUX0AKSAT16	52
						XUX0AKSAT16T	50
							52
						XUX0ARCTT16	52
						XUX0ARCTT16T	50
							52
						XUX1ANANM12	50
						XUX1ANANT16	50
						XUX1ANBNM12	50
						XUX1ANBNT16	50
						XUX1APANM12	50
						XUX1APANT16	50
						XUX1APBNM12	50
						XUX1APBNT16	50



XUX1ARCNT16	50	XUYAFV966S	150	XUY989S●	104	XUZASK003	164	XUZMSV05	34
XUX2ANANM12R	50	XUYAFVCO946S	150	XUYPCO929LSP	106	XUZASM001	164	XUZMSV10	34
XUX2ANANT16R	50	XUYAFVCO966S	150	XUYPCO925L●ANSP	126	XUZASY01A	113	XUZMSV15	34
XUX2ANBNM12R	50	XUYAU005	149	XUYPCO989S●	104	XUZASY01H	113	XUZMSV20	34
XUX2ANBNT16R	50	XUYB952R	154	XUYPS1LCO965S	128	XUZB2003	28	XUZMU01	34
XUX2APANM12R	50	XUYB952S	154	XUYPS2CO945S	130		30	XUZ2000	50
XUX2APANT16R	50	XUYB954R	154	XUYPS989S●	104		32		52
XUX2APBNM12R	50	XUYB954S	154	XUYPS2945S	130		84		164
XUX2APBNT16R	50	XUYB989SN	104	XUYPSCO929L●SP	106		156	XUZ2001	52
XUX2ARCNT16R	50	XUYB989S●	104	XUYPSCO989S●	104		165		165
XUX5ANANM12	50	XUYBCO929LSP	106	XUYR989S●	104	XUZB2005	92	XUZ2002	52
XUX5ANANT16	50		107	XUYRCO989S●	104		164		165
XUX5ANBNM12	50	XUYBCO989SN	104	XUZ200●	28	XUZC08	34	XUZ2003	50
XUX5ANBNT16	50	XUYBCO989SP	104		30		162		52
XUX5APANM12	50	XUYDCFCO966S	76		32	XUZC16	162		165
XUX5APANT16	50	XUYE989	104		38	XUZC21	162	XUZ2004	50
XUX5APBNM12	50	XUYECO989	104		42	XUZC31	162		52
XUX5APBNT16	50	XUYFALNEP400●●	60		44	XUZC39	162		165
XUX5ARCNT16	50	XUYFALNEP40120	60		50	XUZC40S22	162	XZCC12FCM50B	123
XUX8AKSAM12	54	XUYFALNEP600●●	60		52	XUZC50	28	XZCC12FDM50B	123
XUX8AKSAT16	54	XUYFALNEP60120	60		84		30	XZCP0566L2	56
XUX8ARCTT16	54	XUYFALNEP1000●●	60		156		32	XZCP0566L5	56
XUX9ANANM12	50	XUYFALNEP100120	60	XUZA41	164		34	XZCP0666L2	56
XUX9ANANT16	50	XUYFANEP400●●	58	XUZA49	154		42	XZCP0666L5	56
XUX9ANBNM12	50	XUYFANEP40120	58		164		44	XZCP0941L●	58
XUX9ANBNT16	50	XUYFANEP600●●	58	XUZA50	34		50		60
XUX9APANM12	50	XUYFANEP60120	58		38		52		62
XUX9APANT16	50	XUYFANEP1000●●	58		164		84		64
XUX9APBNM12	50	XUYFANEP100120	58	XUZA51	42		86		76
XUX9APBNT16	50	XUYFLNEP400●●	60		44		92		82
XUX9ARCNT16	50	XUYFLNEP40120	60		75		99		106
XUY380NA5D03M8	113	XUYFLNEP600●●	60		91		162		128
XUY410NC3H1M12	113	XUYFLNEP60120	60		164	XUZC50CR	86		130
XUY450NB3N03M8	113	XUYFLNEP1000●●	60	XUZA51S	99		99		150
XUY474NB4H03M12	112	XUYFLNEP100120	60		109		162	XZCP1041L●	58
XUY600NC5H2	113	XUYFNEP400●●	58		126	XUZC50HP	84		60
XUY707ND4P2	113	XUYFNEP40120	58		164		109		62
XUY929	106	XUYFNEP600●●	58	XUZA●18	28	XUZC80	99		64
XUY11●●	104	XUYFNEP60120	58		30		162		76
	106	XUYFNEP1000●●	58		32	XUZC100	99		82
	146	XUYFNEP100120	58		84	XUZC250	123		106
XUY9291	106	XUYFP2BRINA005B	149		92	XUZCR0201CRHP	162		128
XUY9292	106	XUYFPDC61	76		94	XUZCR0401CRHP	162		130
XUYA005	82	XUYFPDC101	76		116	XUZCR0401HP	162		150
	148	XUYFPDCM861	76		120	XUZCR0402	162	XZCP1141L2	126
XUYA110	148	XUYFPDCM8101	76		124	XUZCR0402CR	162	XZCP1141L5	109
XUYA210	148	XUYFVERM●61	144		156	XUZD15	164		126
XUYA211	148		145	XUZA318	116	XUZD25	164	XZCP1164L2	126
XUYA212	149	XUYFVERS●61	144		164	XUZE04	165	XZCP1164L5	126
XUYA213	149		145		164	XUZK2000	75	XZCP1241L5	109
XUYA220	149	XUYFVERT●61	144	XUZA618	123		91	XZCPA1141L5	99
XUYA310	149		145			XUZK200●	42		109
XUYA00510	148	XUYFVPM●61	142	XUZAM01	34		44	XZCPA1241L5	99
XUYA00550	148		143	XUZAM02	34		165		109
XUYAFP946S	150	XUYFVPS●61	142	XUZAM03	34	XUZM200●	38	XZCR1511041C1	113
XUYAFP966S	150		143	XUZAM04	34		165	XZCR1511041C2	113
XUYAFPCO946S	150	XUYFVPTA61	142	XUZASB001	164	XUZMSH05	34	XZCR1512041C1	113
XUYAFPCO966S	150	XUYFVPTC61	143	XUZASK001	109	XUZMSH10	34	XZCR1512041C2	113
XUYAFV946S	150	XUY95●●	154	XUZASK002	109	XUZMSH15	34		
					164	XUZMSH20	34		

**Schneider Electric Industries SAS**

Head Office  
35, rue Joseph Monier  
F-92500 Rueil-Malmaison  
France

[www.tesensors.com](http://www.tesensors.com)

The information provided in this documentation contains general descriptions and/or technical characteristics of the performance of the products contained herein. This documentation is not intended as a substitute for and is not to be used for determining suitability or reliability of these products for specific user applications. It is the duty of any such user or integrator to perform the appropriate and complete risk analysis, evaluation and testing of the products with respect to the relevant specific application or use thereof. Neither Schneider Electric nor any of its affiliates or subsidiaries shall be responsible or liable for misuse of the information contained herein.

Design: Schneider Electric  
Photos: Schneider Electric