



## General Description

The DSC8002 is a programmable MEMS based PureSilicon™ Oscillator. Using the DragonFly™ or TimeFlash™ handheld programmer, the end user can program the DSC8002 within seconds to any frequency from 1 to 150MHz in increments of 100Hz (up to four decimal point resolution). The nominal operational range spans from 1.8 to 3.3 Volts, without any need for additional external components, providing ease of use and flexibility in multi-voltage applications.

The DSC8002 incorporates an all silicon resonator that is extremely robust and nearly immune to stress related fractures, common to crystal based oscillators. Without sacrificing the performance and stability required of today's systems, a crystal-less design allows for a higher level of reliability, making the DSC8002 ideal for rugged, industrial, and portable applications where stress, shock, and vibration can damage quartz crystal based systems.

Available in industry standard packages, the DSC8002 can be "dropped-in" to the same PCB footprint as standard crystal oscillators.

## Block Diagram

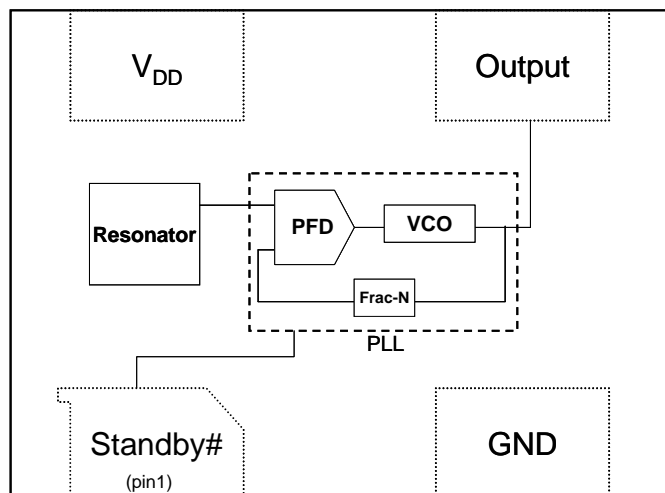

## Features

- Frequency Range: 1 to 150MHz
- Exceptional Stability over Temperature
  - ±25 PPM, ±50 PPM
- Operating voltage
  - 1.8 to 3.3V (nominal)
  - 1.65 to 3.60V (absolute max)
- Operating Temperature Range
  - Industrial -40°C to 85°C
  - Ext. Commercial -20°C to 70°C
  - Commercial 0°C to 70°C
- Low Operating and Standby Current
  - 3mA Operating (40MHz)
  - 1uA Standby
- Ultra Miniature Footprint
  - 2.5 x 2.0 x 0.85 mm
  - 3.2 x 2.5 x 0.85 mm
  - 5.0 x 3.2 x 0.85 mm
  - 7.0 x 5.0 x 0.85 mm
- Excellent shock and Vibration Resistance
- Lead Free, RoHS & Reach SVHC Compliant
- Handheld programmer available for purchase

## Benefits

- Pin for pin "drop in" replacement for industry standard oscillators
- Semiconductor level reliability, significantly higher than quartz
- Frequency Resolution to 4 decimals
- Fully Programmable Operating Voltage and Frequency
- Longer Battery Life / Reduced Power
- Compact Plastic package
- Cost Effective

## Applications

- Mobile Applications
- Consumer Electronics
- Portable Electronics
- CCD Clock for VTR Cameras
- Low Profile Applications
- Industrial

## Absolute Maximum Ratings<sup>1</sup>

Item	Min.	Max	Unit	Condition
Supply Voltage	-0.3	+4.0	V	
Input Voltage	-0.3	VDD+0.3	V	
Junction Temp	-	+150	°C	
Storage Temp	-55	+150	°C	
Soldering Temp	-	+260	°C	40 sec max.
ESD	-		V	
HBM		2000		
MM		200		
CDM		500		

## Ordering Code

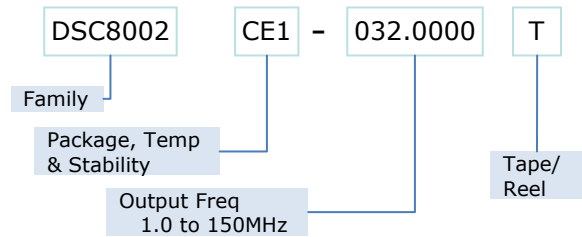

\* See Ordering Information for details

## Recommended Operating Conditions

Parameter	Symbol	Range
Supply Voltage	V <sub>DD</sub>	1.65 – 3.60V
Output Load	Z <sub>L</sub>	R>10KΩ, C≤15pF
Operating Temperature	T	
Option 1		-40 – +85 °C
Option 2		-20 – +70 °C
Option 3		0 – +70 °C

## Specifications

Parameter	Symbol	Condition	Min.	Typ.	Max.	Unit
Frequency	f <sub>0</sub>	Single Frequency	1		150	MHz
Frequency Tolerance						ppm
Option 1		-40°C to +85°C			±25,±50	
Option 2		-20°C to +70°C			±25,±50	
Option 3		0°C to +70°C			±25,±50	
Supply Current, no load	I <sub>DD</sub>	C <sub>L</sub> =0p R <sub>L</sub> =∞ T=25°C	1 to 40MHz 40 to 80MHz 80 to 125MHz 125 to 150MHz	3 4 5 6		mA
Supply Current, standby	I <sub>DD</sub>	T=25°C			1.0	uA
Output Logic Levels						
Output logic high	V <sub>OH</sub>	C <sub>L</sub> =15pF	0.8*V <sub>DD</sub>		-	Volts
Output logic low	V <sub>OL</sub>		-		0.2*V <sub>DD</sub>	
Output Transition time						
Rise Time	t <sub>R</sub>	C <sub>L</sub> =15pF; T=25°C		1.3	2	ns
Fall Time	t <sub>F</sub>	20%/80%*V <sub>DD</sub>		1.3	2	
Output Startup Time <sup>2</sup>	t <sub>SU</sub>	T=25°C		3	10	ms
Output Disable Time	t <sub>DA</sub>			20	100	ns
Output Duty Cycle	SYM		45		55	%
Input Logic Levels						
Input logic high	V <sub>IH</sub>		0.75*V <sub>DD</sub>		-	Volts
Input logic low	V <sub>IL</sub>		-		0.25*V <sub>DD</sub>	
Jitter, Cycle to Cycle	J <sub>CC</sub>	F = 100MHz <sup>3</sup>		95		ps

### Notes:

1. Absolute maximum ratings are those values beyond which the safety of the device cannot be guaranteed. The device should not be operated beyond these limits.
2. Output frequency to within 100ppm of final stable output frequency.
3. See typical cycle to cycle jitter graph for frequency dependence.

## Nominal Performance Characteristics

### 1.8V Characteristics

Supply Current

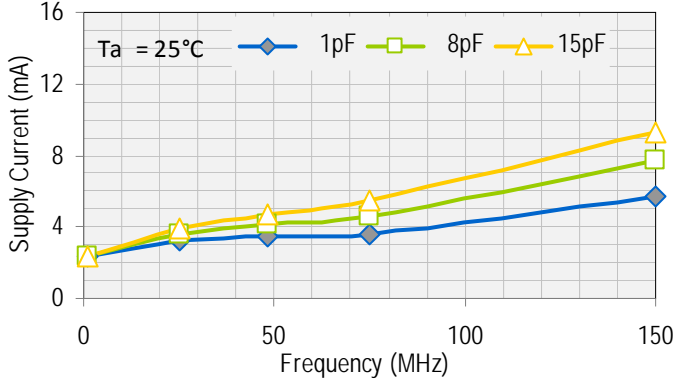

Standby Current

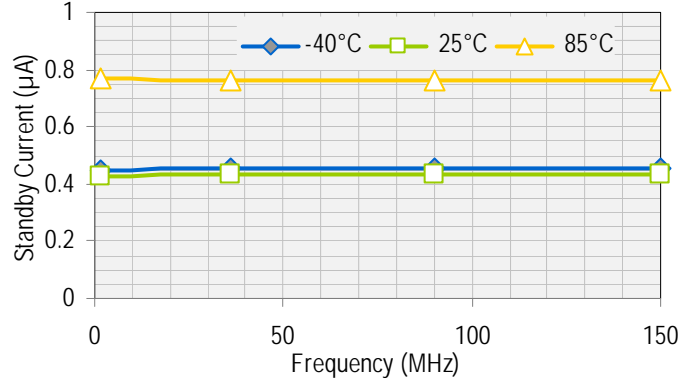

Rise Time

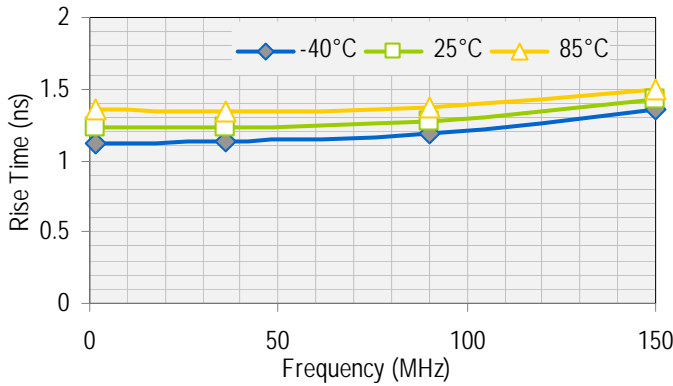

Fall Time

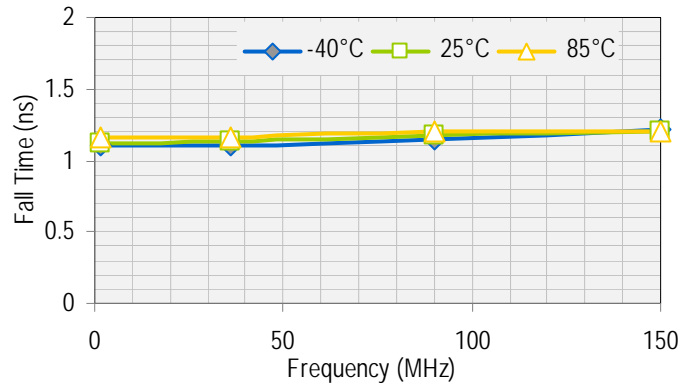

Period Jitter

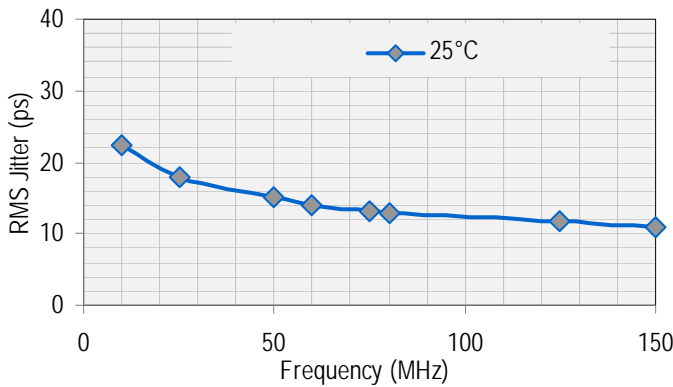

Cycle to Cycle Jitter

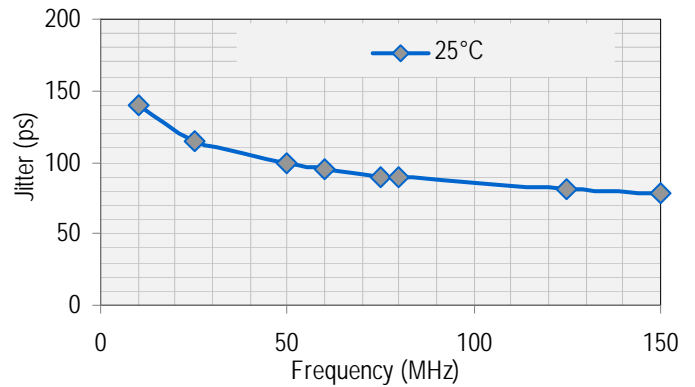

### 3.3V Characteristics

Supply Current

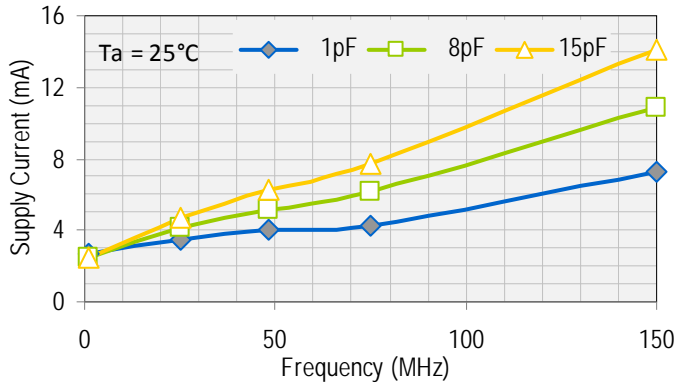

Standby Current

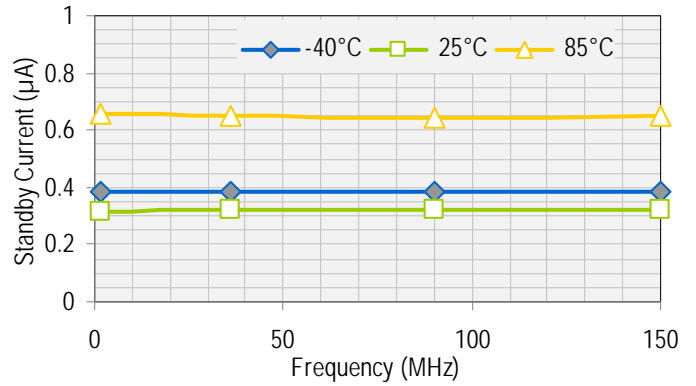

Rise Time

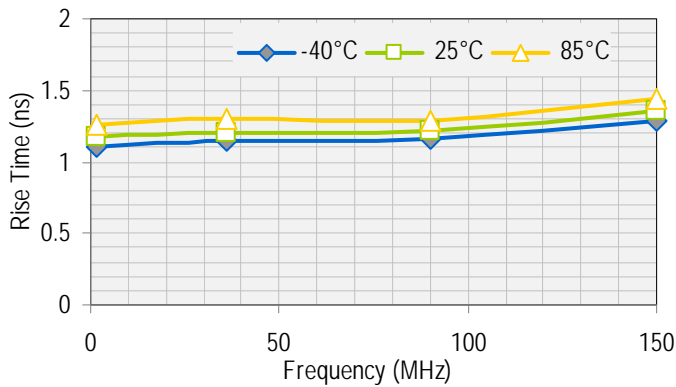

Fall Time

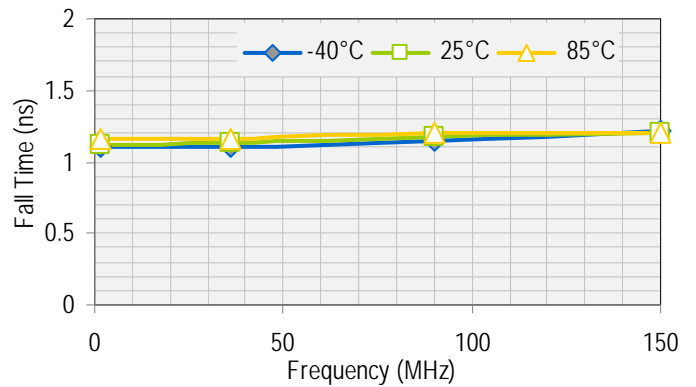

Period Jitter

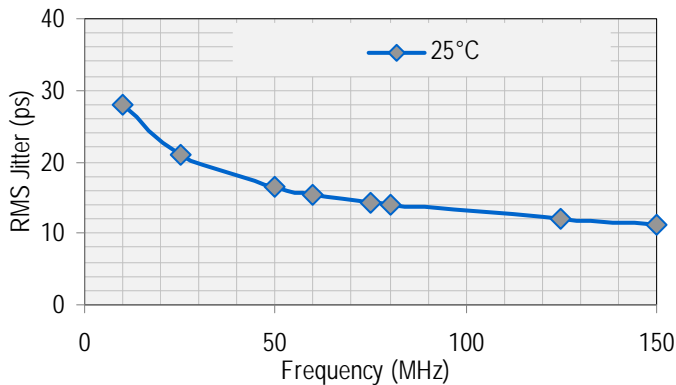

Cycle to Cycle Jitter

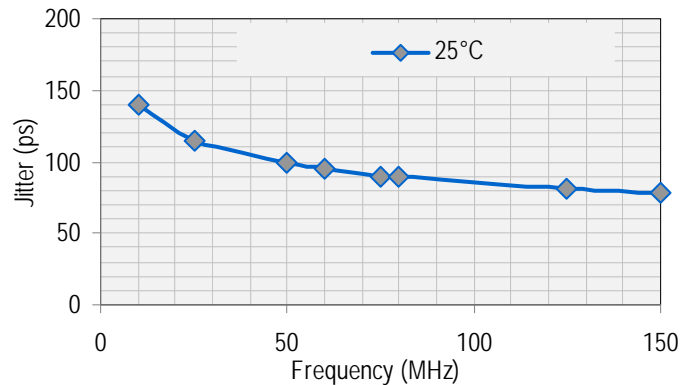

## Output Waveform

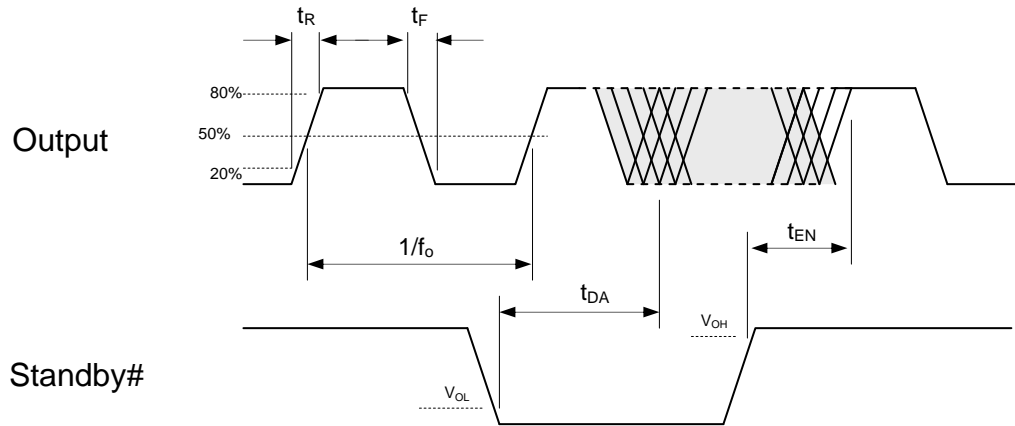

## Standby Function

Standby# (pin 1)	Output (pin 3)
Hi Level	Output ON
Open (no connect)	Output ON
Low Level	High Impedance

## Test Circuit

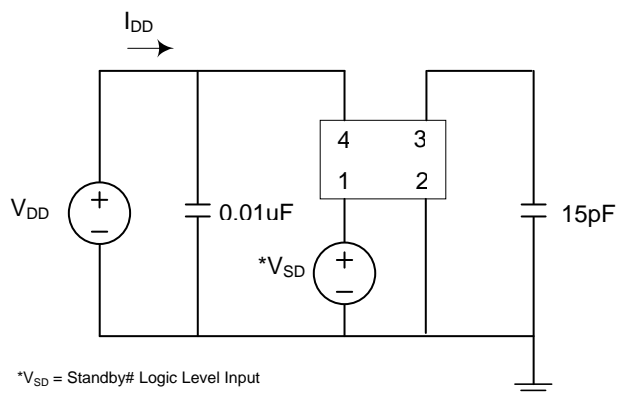

### Board Layout (recommended)

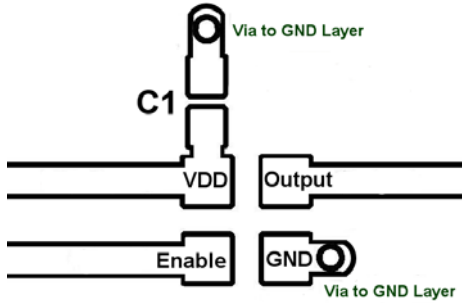

### Solder Reflow Profile

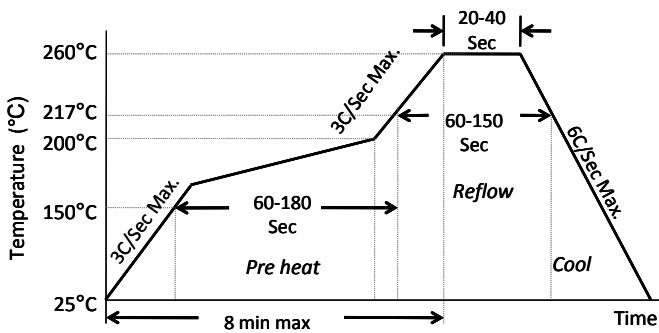

MSL 1 @ 260°C refer to JSTD-020C	
Ramp-Up Rate (200°C to Peak Temp)	3°C/Sec Max.
Preheat Time 150°C to 200°C	60-180 Sec
Time maintained above 217°C	60-150 Sec
Peak Temperature	255-260°C
Time within 5°C of actual Peak	20-40 Sec
Ramp-Down Rate	6°C/Sec Max.
Time 25°C to Peak Temperature	8 min Max.

### Package Dimensions

#### 7.0 x 5.0 mm Plastic Package

#### External Dimensions

#### Recommended Land Pattern\*

No.	Pin Terminal
1	Standby#
2	GND
3	Output
4	VDD

units: mm [inch]

### 5.0 x 3.2 mm Plastic Package

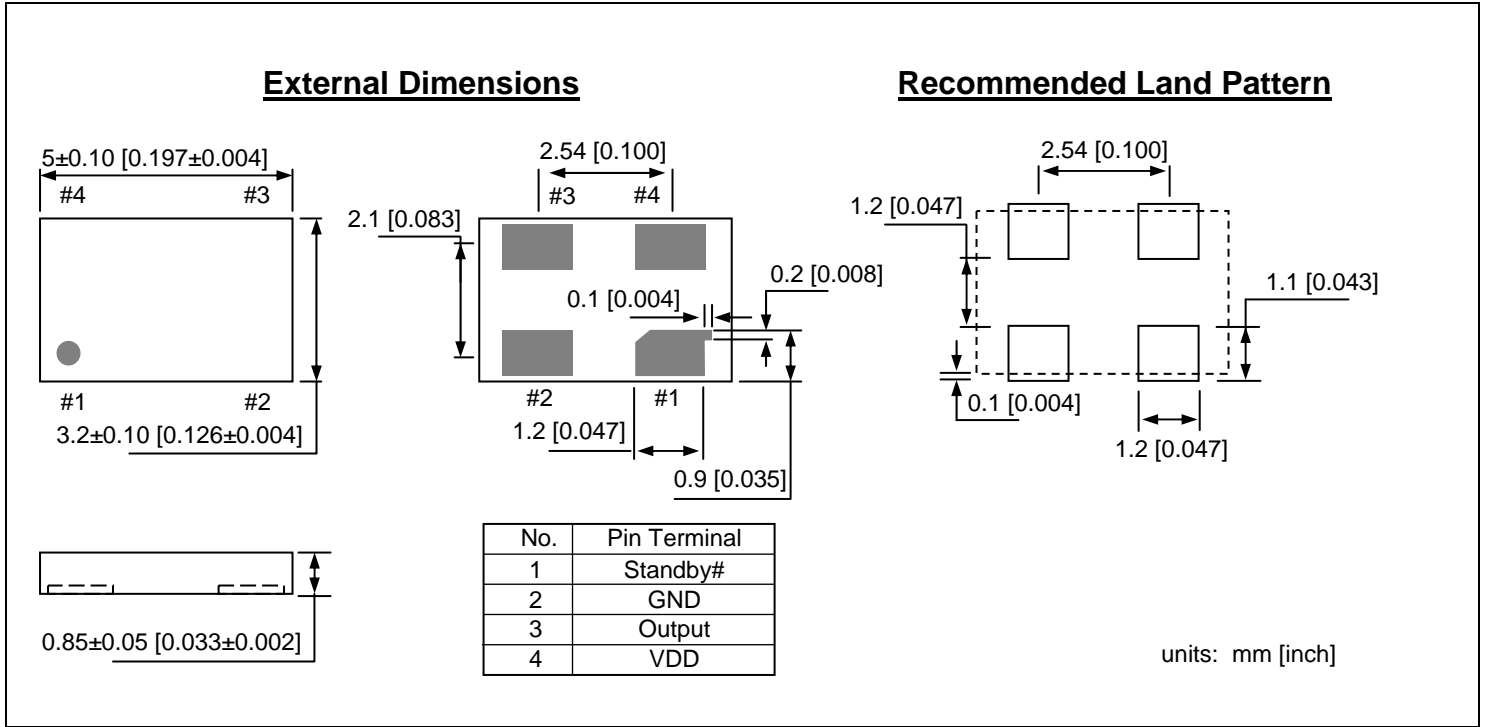

### 3.2 x 2.5 mm Plastic Package

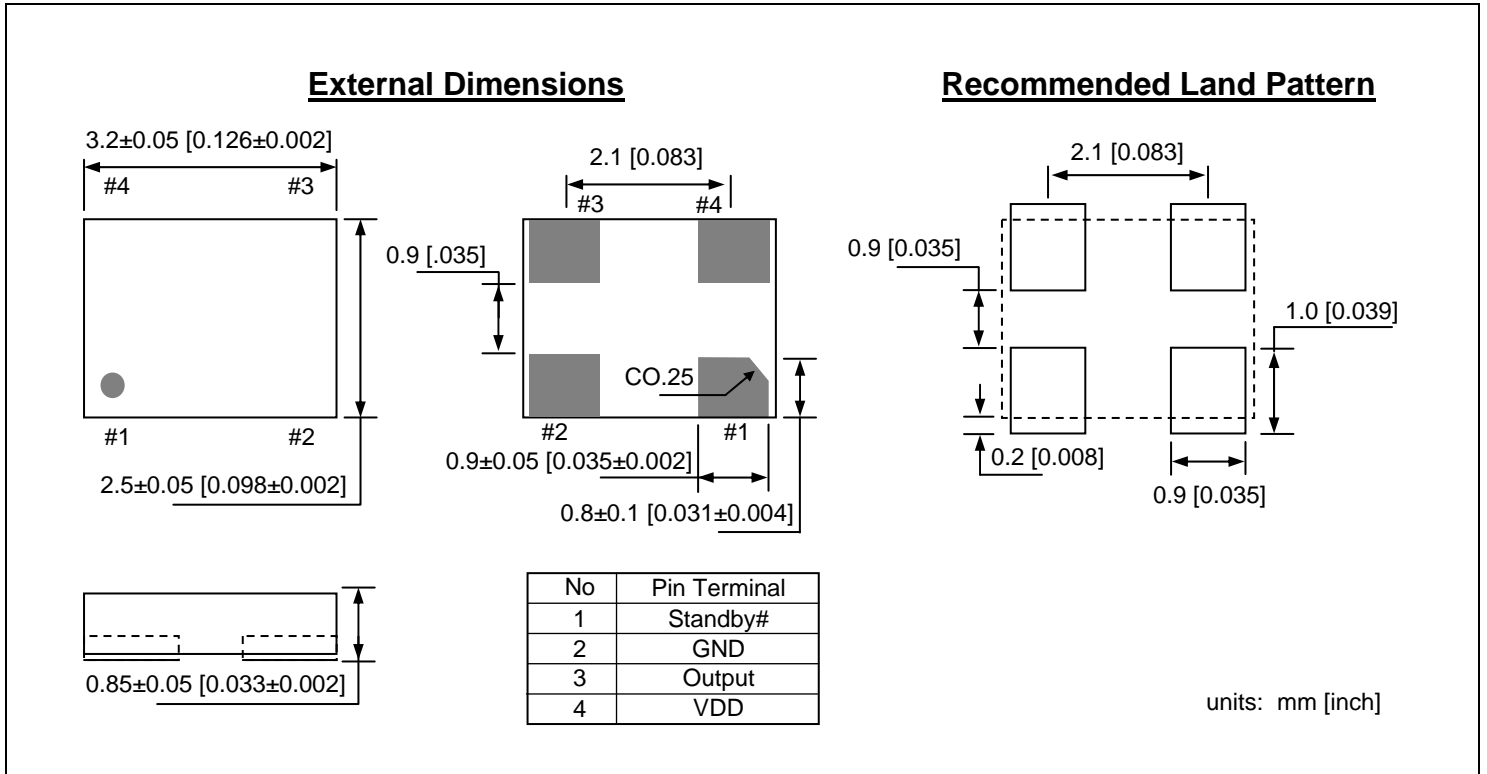

## 2.5 x 2.0 mm Plastic Package

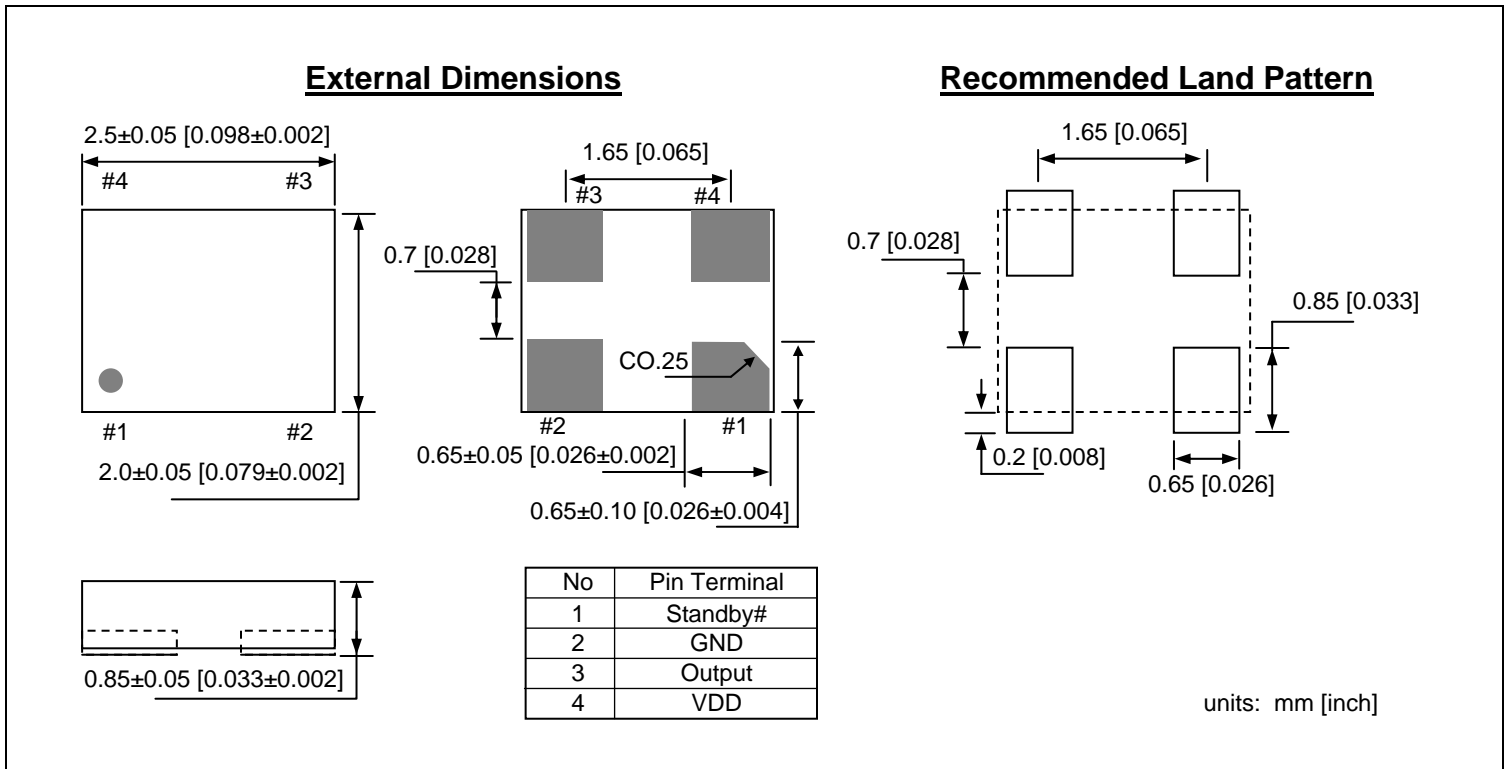

## Ordering Information

### DSC8002 PTS – xxx.xxxx T

PART NUMBERING GUIDE				
Package (Plastic QFN)	Temperature	Stability	Frequency	Packing Option
<b>P=A:</b> 7.0x5.0mm <b>P=B:</b> 5.0x3.2mm <b>P=C:</b> 3.2x2.5mm <b>P=D:</b> 2.5x2.0mm	<b>T=C:</b> 0° ~ +70° C <b>T=E:</b> -20° ~ +70° C <b>T=I:</b> -40° ~ +85° C	<b>S=1:</b> ±50ppm <b>S=2:</b> ±25ppm	<b>XXX.XXXX</b> (4 decimal places)	<b>Blank:</b> Tubes <b>T:</b> Tape & Reel

Example: DSC8002CE1-123.0000T

The example part number above is a 123.0000MHz oscillator in Plastic 3.2x2.5mm package, with ±50ppm stability over an operating temperature of -20 to +70°C, shipped in Tape and Reel. The reel size (7" or 13" diameter) will be determined by the factory based on quantity.

Unprogrammed blank parts can be ordered by omitting the Frequency field. (eg. DSC8002CE1)  
 Unprogrammed parts are shipped in tubes only.