

SKM 600GB066D



SEMITRANS® 3

Trench IGBT Modules

SKM 600GB066D

Features

- Trench = Trenchgate technology
- $V_{CE(sat)}$ with positive temperature coefficient
- High short circuit capability, self limiting to $6 \times I_C$

Typical Applications

- AC inverter drives
- UPS
- Electronic welders

Remarks

- Case temp. limited. to $T = 125^\circ\text{C}$, recomb. $T_{op} = -40 \dots +150^\circ\text{C}$, product rel. results valid for $T_j \leq 150^\circ\text{C}$
- SC data: $t_p \leq 6\mu\text{s}$; $V_{GE} \leq 15\text{V}$; $T_j = 150^\circ\text{C}$; $V_{CC} \leq 360\text{V}$, use of soft R_G necessary !
- Take care of over-voltage caused by stray induct.
- $I_{DC} \leq 500\text{A}$ for $T_{Terminal} = 100^\circ\text{C}$

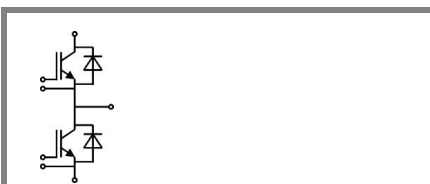

GB

Absolute Maximum Ratings		$T_{case} = 25^\circ\text{C}$, unless otherwise specified		
Symbol	Conditions	Values	Units	
IGBT				
V_{CES}	$T_j = 25^\circ\text{C}$	600	V	
I_C	$T_j = 175^\circ\text{C}$	$T_c = 25^\circ\text{C}$	760	A
		$T_c = 80^\circ\text{C}$	570	A
I_{CRM}	$I_{CRM} = 1,33 \times I_{Cnom}$	800	A	
V_{GES}		± 20	V	
t_{psc}	$V_{CC} = 360\text{V}$; $V_{GE} \leq 15\text{V}$; $T_j = 150^\circ\text{C}$ $V_{CES} < 600\text{V}$	6	μs	
Inverse Diode				
I_F	$T_j = 175^\circ\text{C}$	$T_c = 25^\circ\text{C}$	700	A
		$T_c = 80^\circ\text{C}$	510	A
I_{FRM}	$I_{FRM} = 1,33 \times I_{Fnom}$	800	A	
Module				
$I_{t(RMS)}$		500	A	
T_{vj}		- 40 + 175	$^\circ\text{C}$	
T_{stg}		- 40 + 125	$^\circ\text{C}$	
V_{isol}	AC, 1 min.	4000	V	

Characteristics		$T_{case} = 25^\circ\text{C}$, unless otherwise specified			
Symbol	Conditions	min.	typ.	max.	Units
IGBT					
$V_{GE(th)}$	$V_{GE} = V_{CE}$; $I_C = 9,6\text{mA}$	5	5,8	6,5	V
I_{CES}	$V_{GE} = 0\text{V}$; $V_{CE} = V_{CES}$		0,3	0,9	mA
V_{CE0}		$T_j = 25^\circ\text{C}$	0,9	1	V
		$T_j = 150^\circ\text{C}$	0,85	0,9	V
r_{CE}	$V_{GE} = 15\text{V}$	$T_j = 25^\circ\text{C}$	0,9	1,5	$\text{m}\Omega$
		$T_j = 150^\circ\text{C}$	1,4	2	$\text{m}\Omega$
$V_{CE(sat)}$	$I_{Cnom} = 600\text{A}$; $V_{GE} = 15\text{V}$	$T_j = 25^\circ\text{C}_{chiplev.}$	1,45	1,9	V
		$T_j = 150^\circ\text{C}_{chiplev.}$	1,7	2,1	V
C_{ies}	$V_{CE} = 25$; $V_{GE} = 0\text{V}$	$f = 1\text{MHz}$	37		nF
C_{oes}			2,3		nF
C_{res}			1,1		nF
Q_G	$V_{GE} = -8\text{V} \dots +15\text{V}$		4400		nC
R_{Gint}	$T_j = ^\circ\text{C}$		0,5		Ω
$t_{d(on)}$	$R_{Gon} = 1,5\Omega$	$V_{CC} = 300\text{V}$ $I_C = 600\text{A}$	270		ns
t_r			77		ns
E_{on}	$R_{Goff} = 1,5\Omega$	$T_j = 150^\circ\text{C}$ $V_{GE} = -8\text{V}/+15\text{V}$	7,5		mJ
$t_{d(off)}$			670		ns
t_f			77		ns
E_{off}			29,5		mJ
$R_{th(j-c)}$	per IGBT			0,08	K/W

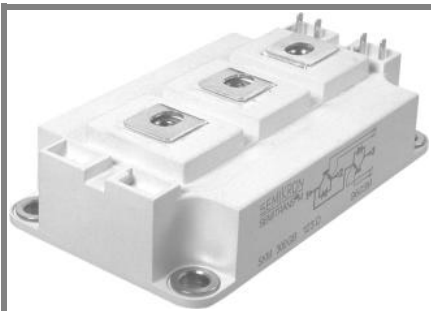

SEMITRANS® 3

Trench IGBT Modules

SKM 600GB066D

Features

- Trench = Trenchgate technology
- $V_{CE(sat)}$ with positive temperature coefficient
- High short circuit capability, self limiting to $6 \times I_C$

Typical Applications

- AC inverter drives
- UPS
- Electronic welders

Remarks

- Case temp. limited. to $T = 125^\circ\text{C}$, recomb. $T_{op} = -40 \dots +150^\circ\text{C}$, product rel. results valid for $T_j \leq 150^\circ\text{C}$
- SC data: $t_p \leq 6\mu\text{s}$; $V_{GE} \leq 15\text{V}$; $T_j = 150^\circ\text{C}$; $V_{CC} \leq 360\text{V}$, use of soft R_G necessary !
- Take care of over-voltage caused by stray induct.
- $I_{DC} \leq 500\text{A}$ for $T_{Terminal} = 100^\circ\text{C}$

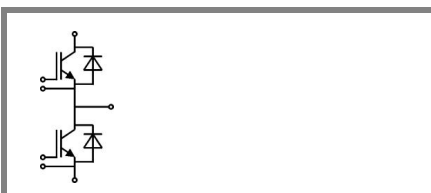

GB

Characteristics

Symbol	Conditions	min.	typ.	max.	Units
Inverse Diode					
$V_F = V_{EC}$	$I_{Fnom} = 600\text{ A}$; $V_{GE} = 0\text{ V}$ $T_j = 25^\circ\text{C}_{chiplev.}$		1,4	1,6	V
V_{F0}	$T_j = 25^\circ\text{C}$		0,95	1	V
r_F	$T_j = 25^\circ\text{C}$		0,8	1	mΩ
I_{RRM}	$I_F = 600\text{ A}$ $T_j = 150^\circ\text{C}$		580		A
Q_{rr}	$di/dt = 8600\text{ A}/\mu\text{s}$		105		μC
E_{rr}	$V_{GE} = -8\text{ V}$; $V_{CC} = 300\text{ V}$		25		mJ
$R_{th(j-c)D}$	per diode			0,125	K/W
Module					
L_{CE}			15	20	nH
R_{CC+EE}	res., terminal-chip $T_{case} = 25^\circ\text{C}$		0,35		mΩ
	$T_{case} = 125^\circ\text{C}$		0,5		mΩ
$R_{th(c-s)}$	per module			0,038	K/W
M_s	to heat sink M6	3		5	Nm
M_t	to terminals M6	2,5		5	Nm
w				325	g

This is an electrostatic discharge sensitive device (ESDS), international standard IEC 60747-1, Chapter IX.

This technical information specifies semiconductor devices but promises no characteristics. No warranty or guarantee expressed or implied is made regarding delivery, performance or suitability.

SKM 600GB066D

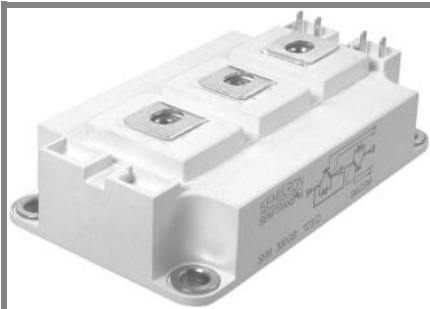

SEMITRANS® 3

Trench IGBT Modules

SKM 600GB066D

Features

- Trench = Trenchgate technology
- $V_{CE(sat)}$ with positive temperature coefficient
- High short circuit capability, self limiting to $6 \times I_C$

Typical Applications

- AC inverter drives
- UPS
- Electronic welders

Remarks

- Case temp. limited. to $T = 125^\circ\text{C}$, recomb. $T_{op} = -40 \dots +150^\circ\text{C}$, product rel. results valid for $T_j \leq 150^\circ\text{C}$
- SC data: $t_p \leq 6\mu\text{s}$; $V_{GE} \leq 15\text{V}$; $T_j = 150^\circ\text{C}$; $V_{cc} \leq 360\text{V}$, use of soft R_G necessary !
- Take care of over-voltage caused by stray induct.
- $I_{DC} \leq 500\text{A}$ for $T_{Terminal} = 100^\circ\text{C}$

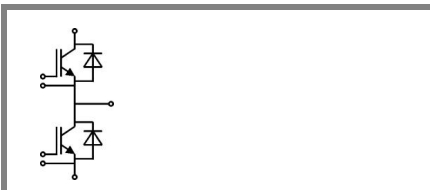

GB

Z_{th}			
Symbol	Conditions	Values	Units
$Z_{th(j-c)I}$			
$R_{\theta i}$	$i = 1$	48,4	mk/W
$R_{\theta i}$	$i = 2$	19,5	mk/W
$R_{\theta i}$	$i = 3$	3,1	mk/W
$R_{\theta i}$	$i = 4$	4	mk/W
$\tau_{\theta i}$	$i = 1$	0,054	s
$\tau_{\theta i}$	$i = 2$	0,0144	s
$\tau_{\theta i}$	$i = 3$	0,0012	s
$\tau_{\theta i}$	$i = 4$	0,0026	s
$Z_{th(j-c)D}$			
$R_{\theta i}$	$i = 1$	80	mk/W
$R_{\theta i}$	$i = 2$	33	mk/W
$R_{\theta i}$	$i = 3$	10,5	mk/W
$R_{\theta i}$	$i = 4$	1,5	mk/W
$\tau_{\theta i}$	$i = 1$	0,054	s
$\tau_{\theta i}$	$i = 2$	0,01	s
$\tau_{\theta i}$	$i = 3$	0,0007	s
$\tau_{\theta i}$	$i = 4$	0,0019	s

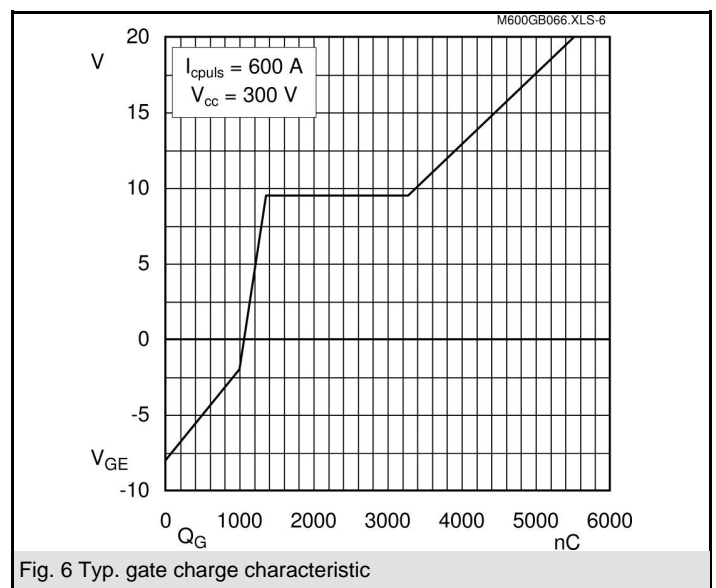
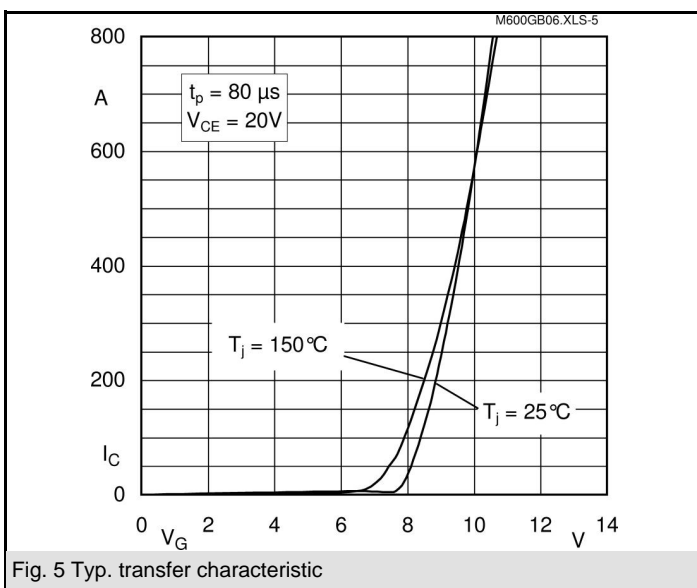
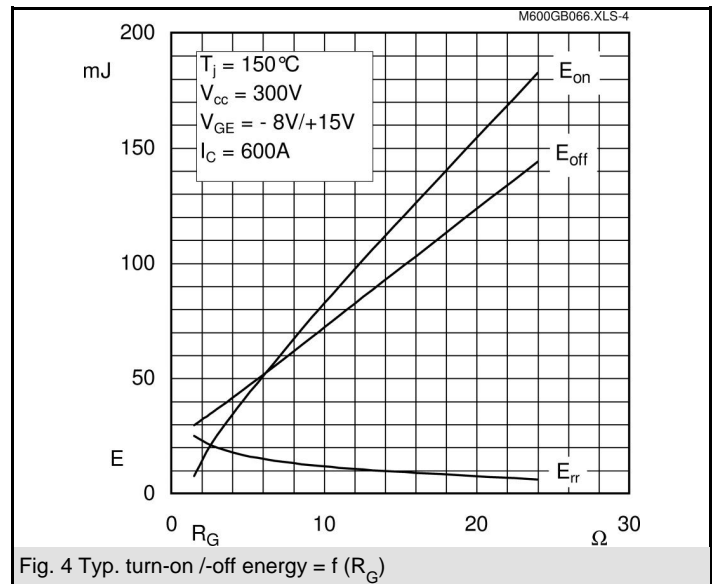
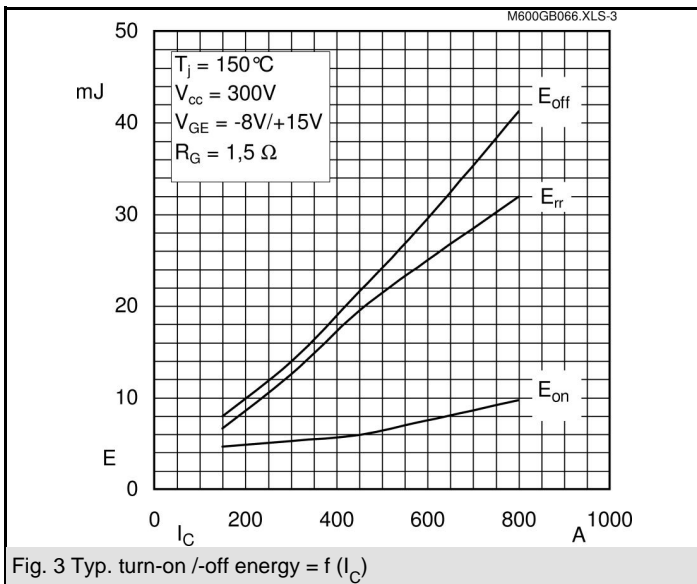
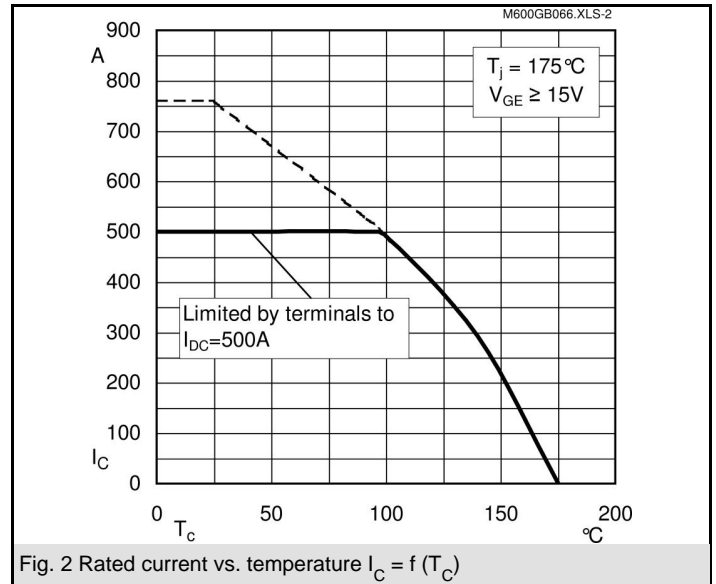
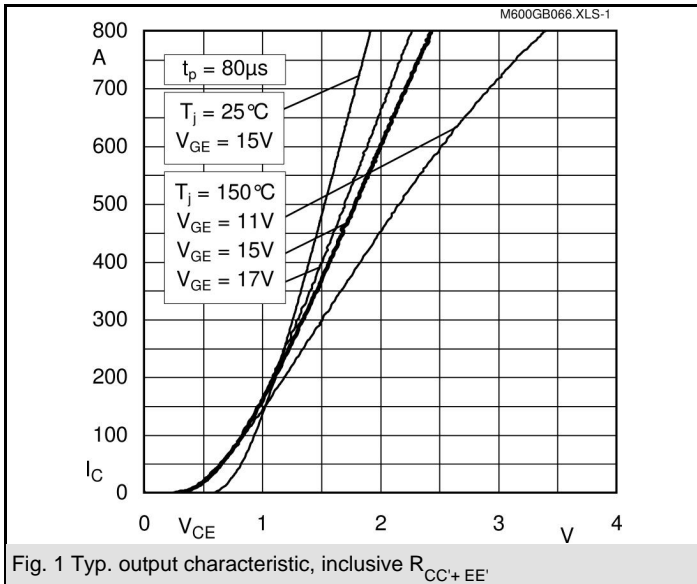

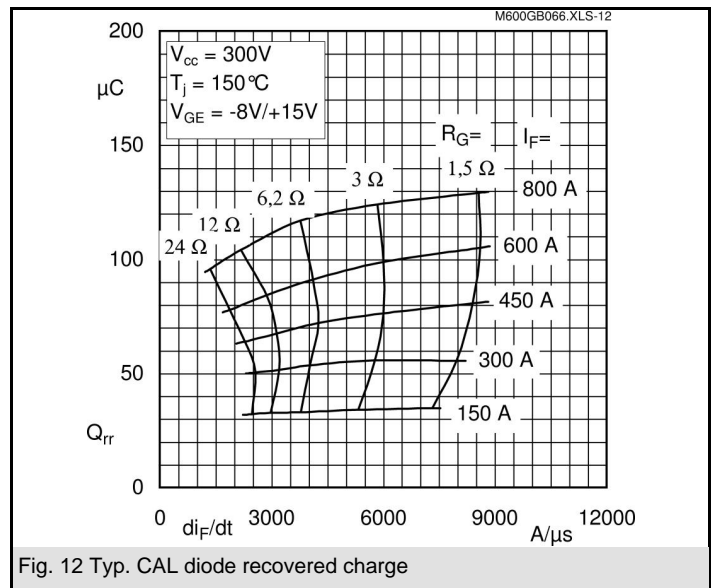
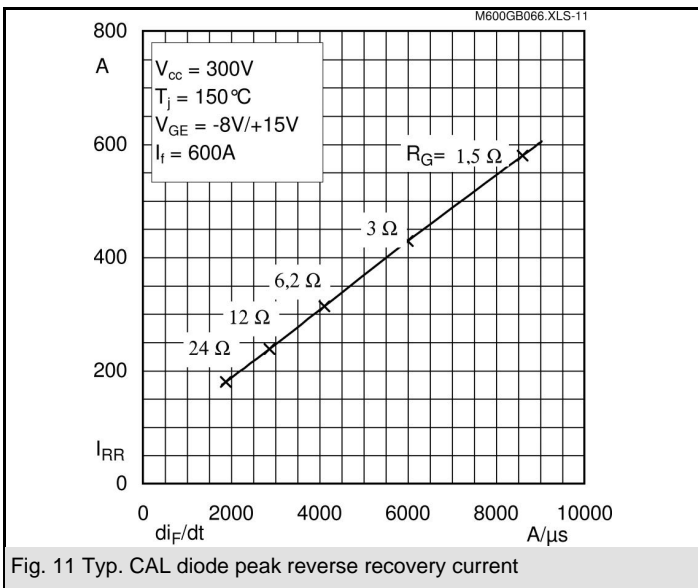
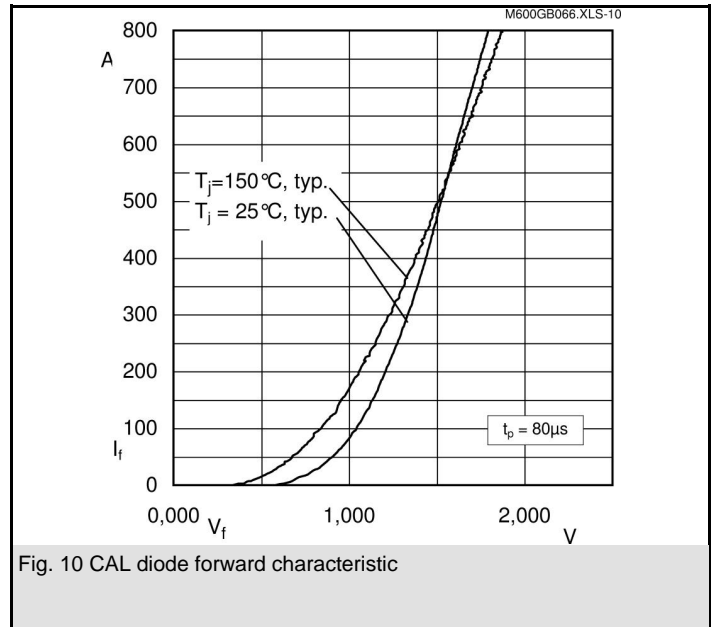
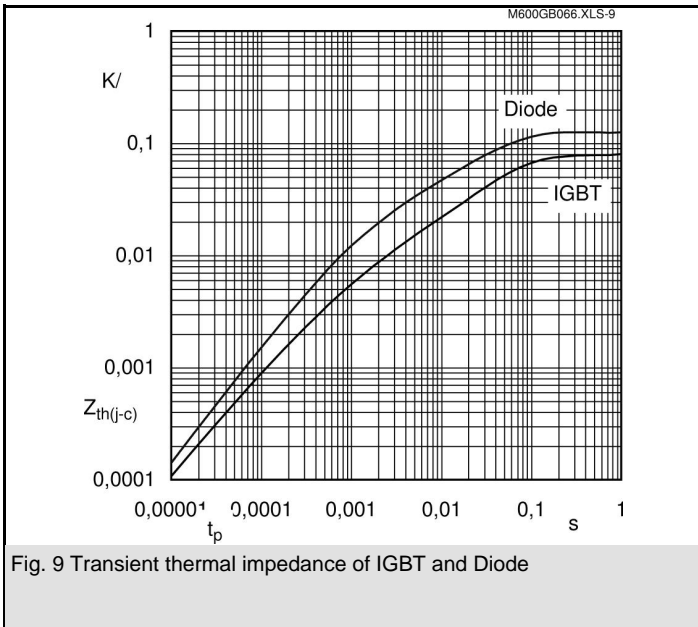
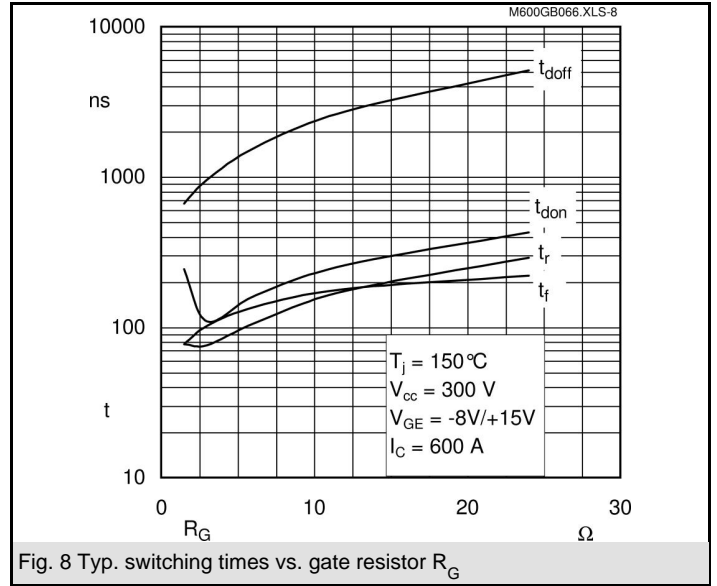
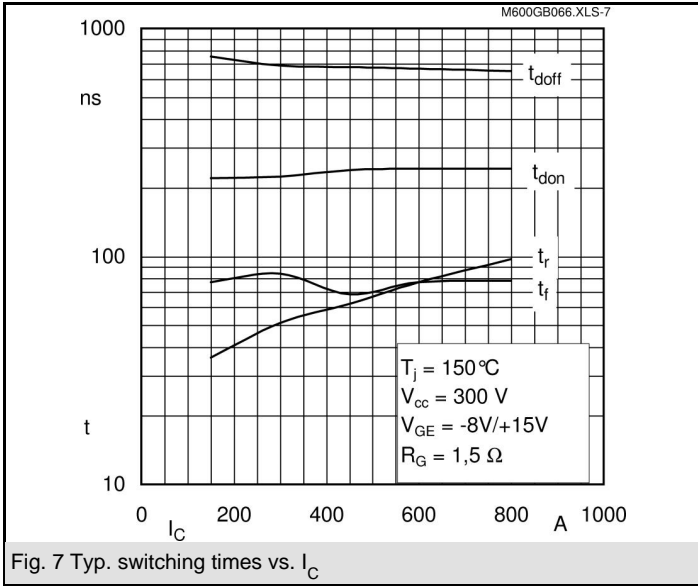

SKM 600GB066D

UL recognized, file no. E 63 532

CASED56

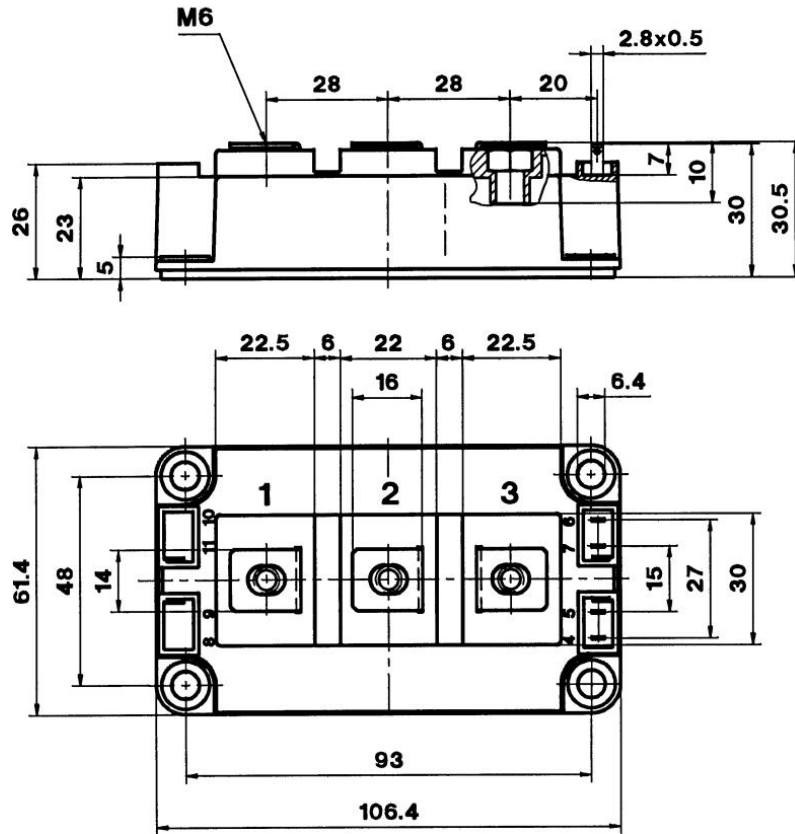

Case D 56

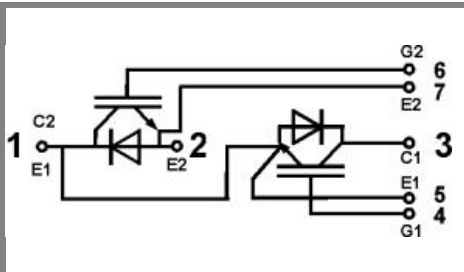

GB

Case D56