

SKM150GB12T4

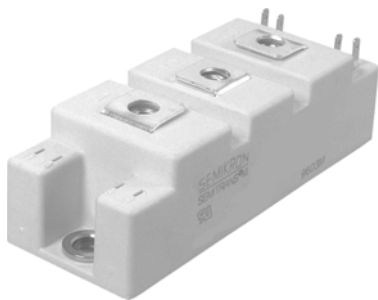

SEMITRANS®2

Fast IGBT4 Modules

SKM150GB12T4

Features

- IGBT4 = 4. Generation (Trench)IGBT
- VCEsat with positive temperature coefficient
- High short circuit capability, self limiting to 6 x I_{CNOM}
- Soft switching 4. Generation CAL diode (CAL4)

Typical Applications

- AC inverter drives
- UPS
- Electronic welders at fsw up to 20 kHz

Remarks

- Case temperature limited to T_c = 125°C max, recomm. Top = -40 ... +150°C, product rel. results valid for T_j = 150°

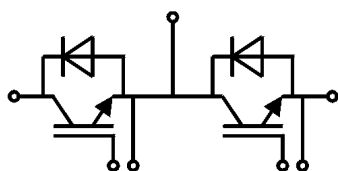

GB

Absolute Maximum Ratings				
Symbol	Conditions	Values	Unit	
IGBT				
V _{CEs}		1200	V	
I _C	T _j = 175 °C	T _c = 25 °C	232	A
		T _c = 80 °C	179	A
I _{Cnom}		150	A	
I _{CRM}	I _{CRM} = 3xI _{Cnom}	450	A	
V _{GES}		-20 ... 20	V	
t _{psc}	V _{CC} = 800 V	T _j = 150 °C	10	µs
	V _{GE} ≤ 15 V			
	V _{CEs} ≤ 1200 V			
T _j		-40 ... 175		°C
Inverse diode				
I _F	T _j = 175 °C	T _c = 25 °C	189	A
		T _c = 80 °C	141	A
I _{Fnom}		150	A	
I _{FRM}	I _{FRM} = 3xI _{Fnom}	450	A	
I _{FSM}	t _p = 10 ms, sin 180°, T _j = 25 °C	900	A	
T _j		-40 ... 175		°C
Module				
I _{t(RMS)}		200		A
T _{stg}		-40 ... 125		°C
V _{isol}	AC sinus 50Hz, t = 1 min	4000		V

Characteristics					
Symbol	Conditions	min.	typ.	max.	Unit
IGBT					
V _{CE(sat)}	I _C = 150 A V _{GE} = 15 V chiplevel	T _j = 25 °C	1.8	2.05	V
		T _j = 150 °C	2.2	2.4	V
V _{CE0}		T _j = 25 °C	0.8	0.9	V
		T _j = 150 °C	0.7	0.8	V
r _{CE}	V _{GE} = 15 V	T _j = 25 °C	6.7	7.7	mΩ
		T _j = 150 °C	10.0	10.7	mΩ
V _{GE(th)}	V _{GE} =V _{CE} , I _C = 6 mA	5	5.8	6.5	V
I _{CES}	V _{GE} = 0 V V _{CE} = 1200 V	T _j = 25 °C	0.1	0.3	mA
		T _j = 150 °C			mA
C _{ies}	V _{CE} = 25 V	f = 1 MHz	9.3		nF
C _{oes}	V _{GE} = 0 V	f = 1 MHz	0.58		nF
C _{res}		f = 1 MHz	0.51		nF
Q _G	V _{GE} = - 8 V...+ 15 V		850		nC
R _{Gint}	T _j = 25 °C		5.0		Ω
t _{d(on)}	V _{CC} = 600 V	T _j = 150 °C	180		ns
t _r	I _C = 150 A V _{GE} = ±15 V	T _j = 150 °C	42		ns
			19.2		mJ
E _{on}	R _{G on} = 1 Ω	T _j = 150 °C			
t _{d(off)}	R _{G off} = 1 Ω	T _j = 150 °C	410		ns
t _f	di/dt _{on} = 3400 A/µs	T _j = 150 °C	72		ns
E _{off}	di/dt _{off} = 1750 A/µs	T _j = 150 °C	15.8		mJ
R _{th(j-c)}	per IGBT			0.19	K/W



SEMITRANS®2

Fast IGBT4 Modules

SKM150GB12T4

Features

- IGBT4 = 4. Generation (Trench)IGBT
- VCEsat with positive temperature coefficient
- High short circuit capability, self limiting to $6 \times I_{CNOM}$
- Soft switching 4. Generation CAL diode (CAL4)

Typical Applications

- AC inverter drives
- UPS
- Electronic welders at fsw up to 20 kHz

Remarks

- Case temperature limited to $T_c = 125^\circ\text{C}$ max, recomm.
Top = $-40 \dots +150^\circ\text{C}$, product rel. results valid for $T_j = 150^\circ$

Characteristics						
Symbol	Conditions		min.	typ.	max.	Unit
Inverse diode						
$V_F = V_{EC}$	$I_F = 150 \text{ A}$ $V_{GE} = 0 \text{ V}$ chip	$T_j = 25^\circ\text{C}$		2.14	2.46	V
		$T_j = 150^\circ\text{C}$		2.07	2.38	V
V_{F0}		$T_j = 25^\circ\text{C}$		1.3	1.5	V
		$T_j = 150^\circ\text{C}$		0.9	1.1	V
r_F		$T_j = 25^\circ\text{C}$		5.6	6.4	m Ω
		$T_j = 150^\circ\text{C}$		7.8	8.5	m Ω
I_{RRM}	$I_F = 150 \text{ A}$ $di/dt_{off} = 3100 \text{ A}/\mu\text{s}$ $V_{GE} = \pm 15 \text{ V}$ $V_{CC} = 600 \text{ V}$	$T_j = 150^\circ\text{C}$		120		A
Q_{rr}		$T_j = 150^\circ\text{C}$		31.3		μC
E_{rr}		$T_j = 150^\circ\text{C}$			13	
$R_{th(j-c)}$	per diode				0.31	K/W
Module						
L_{CE}					30	nH
$R_{CC'+EE'}$	terminal-chip	$T_c = 25^\circ\text{C}$		0.65		m Ω
		$T_c = 125^\circ\text{C}$		1		m Ω
$R_{th(c-s)}$	per module			0.04	0.05	K/W
M_s	to heat sink M6			3	5	Nm
M_t		to terminals M5		2.5	5	Nm
						Nm
w					160	g

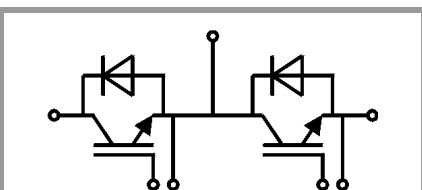

GB

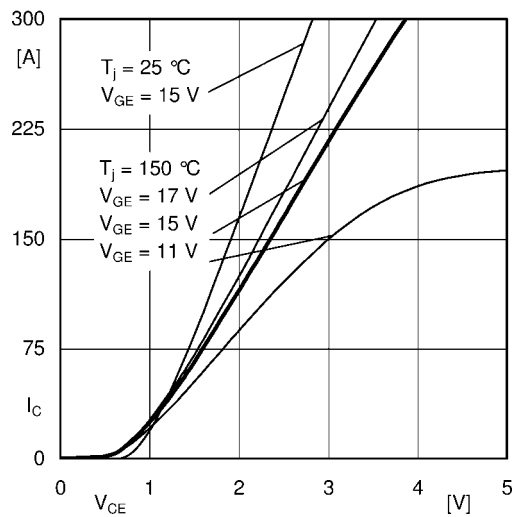

Fig. 1: Typ. output characteristic, inclusive $R_{CC'+EE'}$

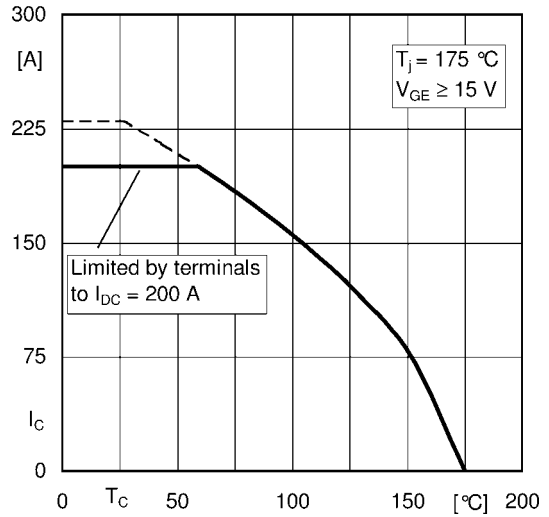

Fig. 2: Rated current vs. temperature $I_C = f(T_C)$

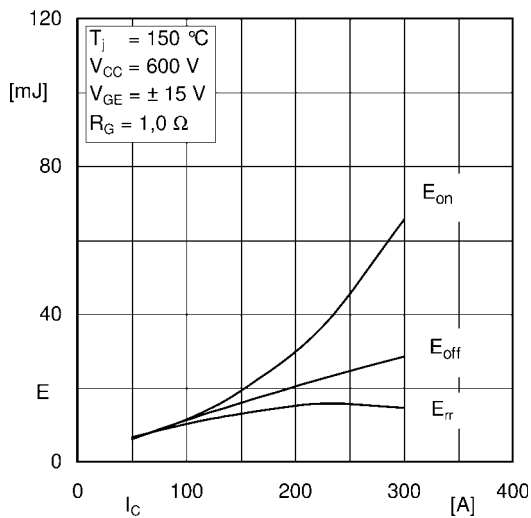

Fig. 3: Typ. turn-on /-off energy = $f(I_C)$

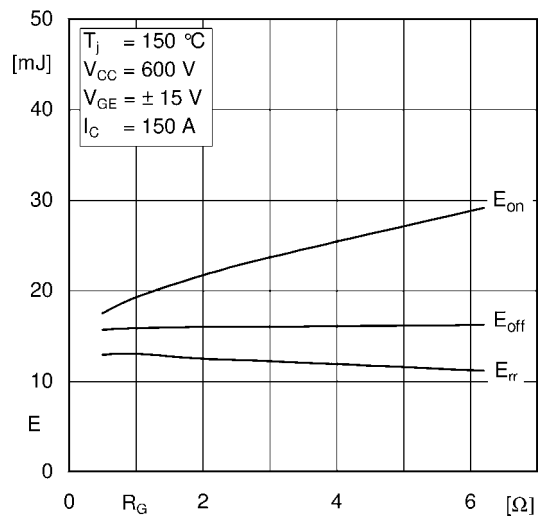

Fig. 4: Typ. turn-on /-off energy = $f(R_G)$

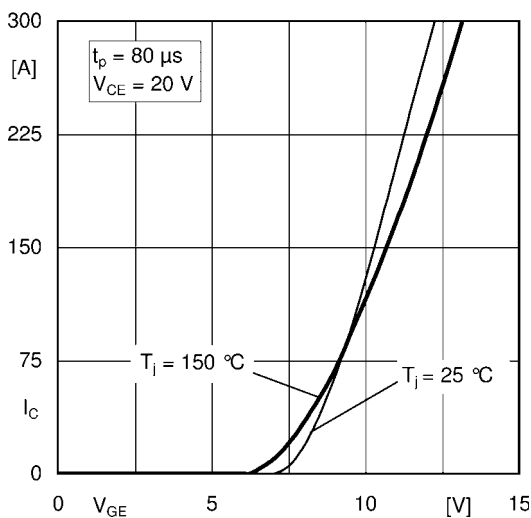

Fig. 5: Typ. transfer characteristic

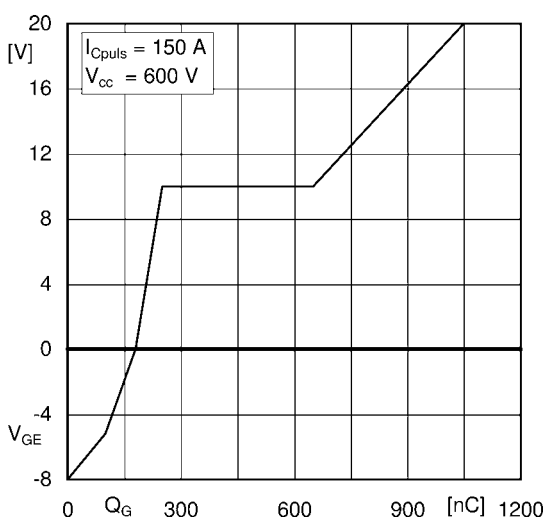

Fig. 6: Typ. gate charge characteristic

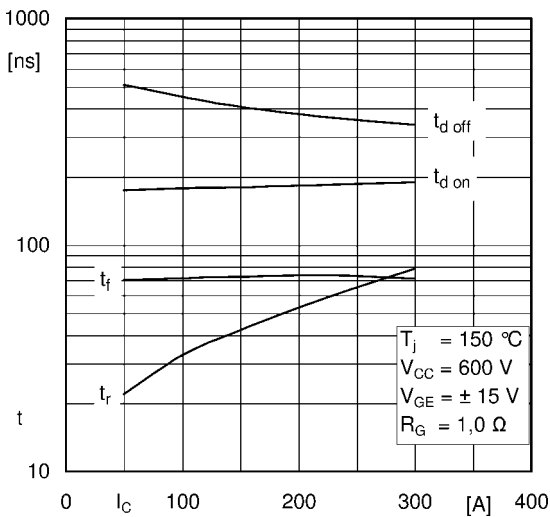

Fig. 7: Typ. switching times vs. I_C

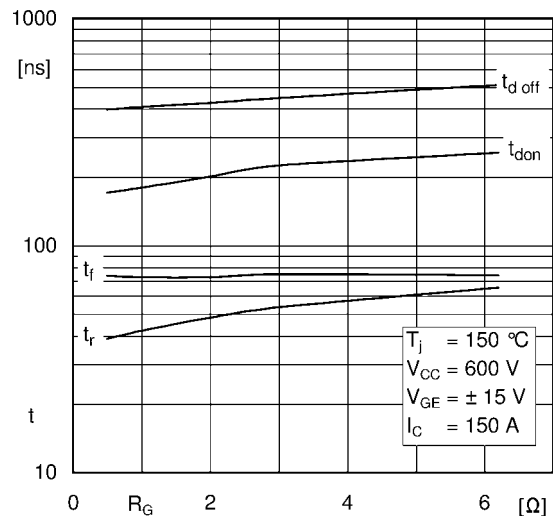

Fig. 8: Typ. switching times vs. gate resistor R_G

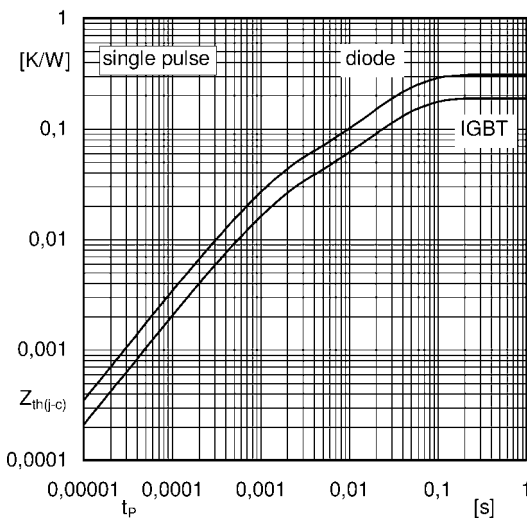

Fig. 9: Transient thermal impedance

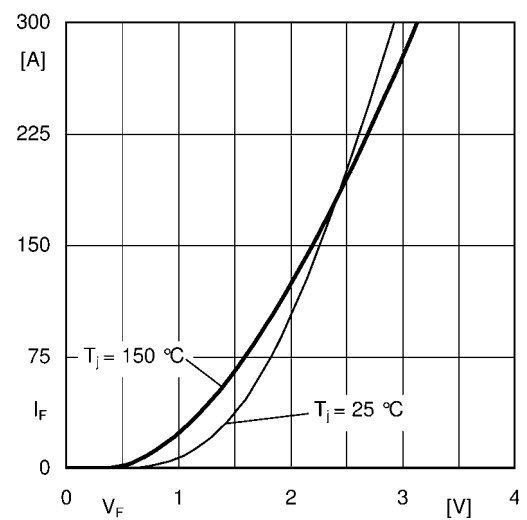

Fig. 10: CAL diode forward characteristic

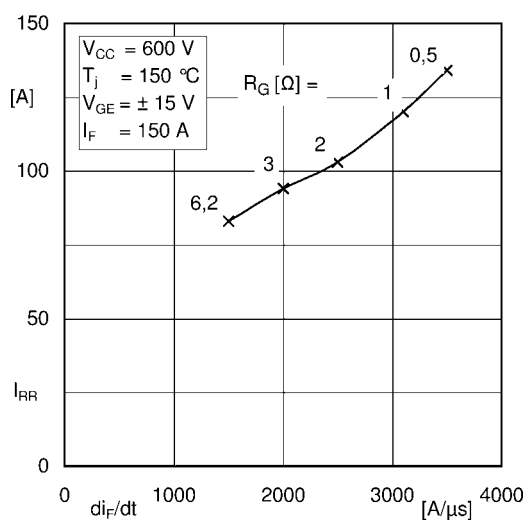

Fig. 11: CAL diode peak reverse recovery current

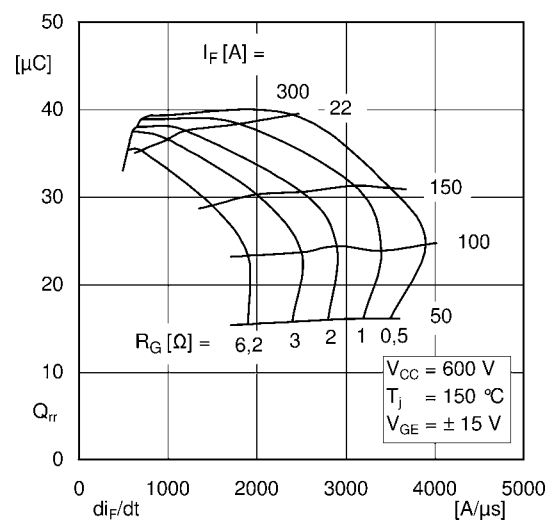
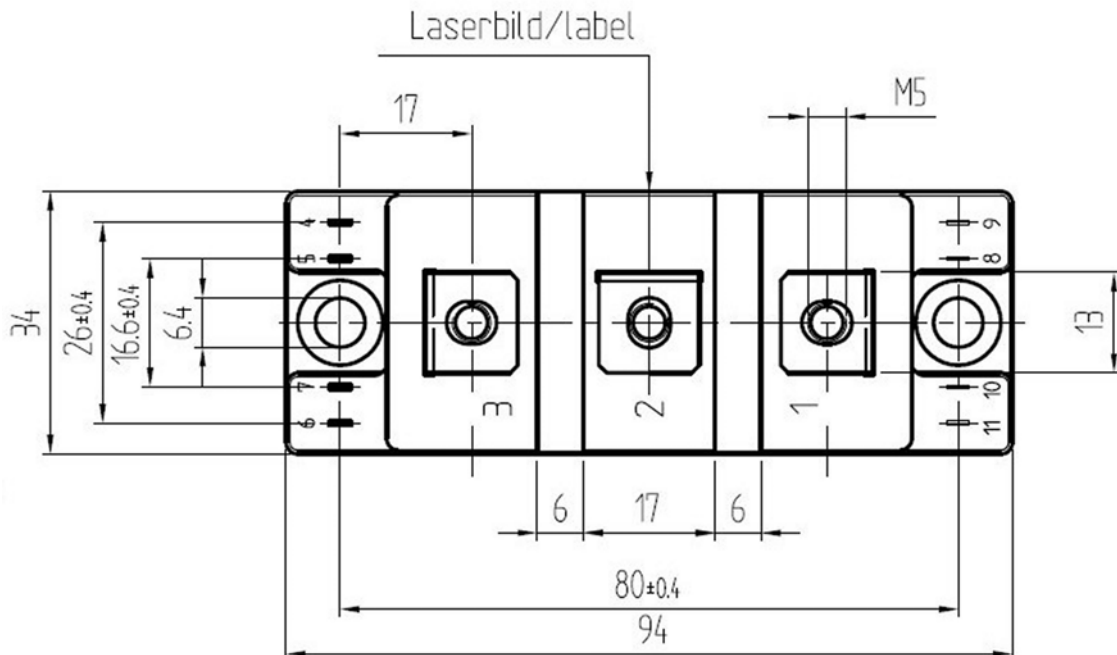
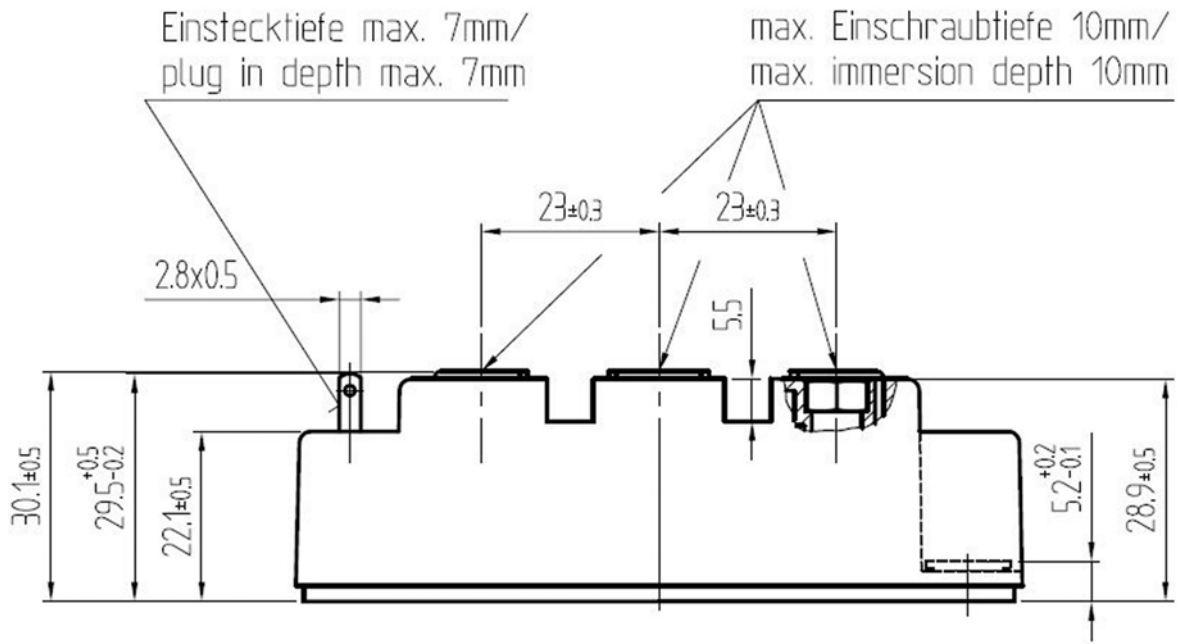
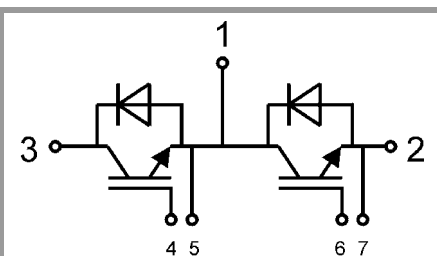

Fig. 12: Typ. CAL diode peak reverse recovery charge

SKM150GB12T4



Semitrans 2



GB

This is an electrostatic discharge sensitive device (ESDS), international standard IEC 60747-1, Chapter IX.

This technical information specifies semiconductor devices but promises no characteristics. No warranty or guarantee expressed or implied is made regarding delivery, performance or suitability.