



STGE50NC60WD

N-channel 50A - 600V - ISOTOP
Ultra fast switching PowerMESH™ IGBT

Features

Type	V _{CES}	V _{CE(sat)} (Max) @25°C	I _C @100°C
STGE50NC60WD	600V	2.5V	50A

- High current capability
- High frequency operation
- Low C_{RES}/C_{I_{ES}} ratio (no cross-conduction susceptibility)
- Very soft ultra fast recovery antiparallel diode

Description

Using the latest high voltage technology based on a patented strip layout, STMicroelectronics has designed an advanced family of IGBTs, the PowerMESH™ IGBTs, with outstanding performances. The suffix “W” identifies a family optimized for very high frequency applications.

Applications

- Very high frequency inverters
- HF, SMPS and PFC in both hard switching and resonant topologies
- UPS
- Motor drivers
- Welding

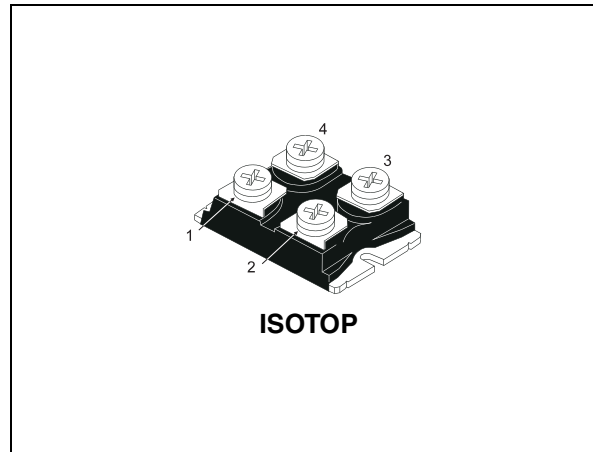

Figure 1. Internal schematic diagram

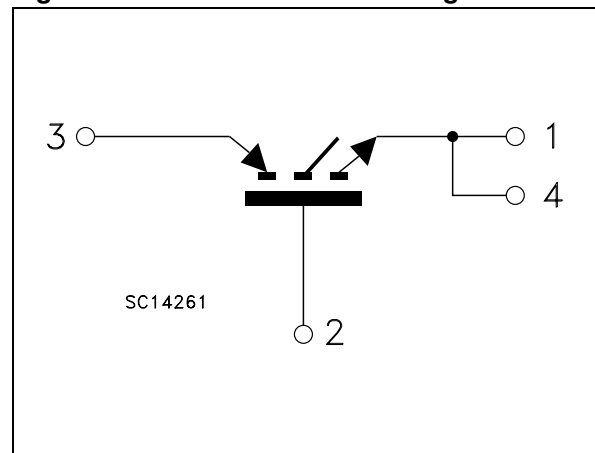

Table 1. Device summary

Order code	Marking	Package	Packaging
STGE50NC60WD	GE50NC60WD	ISOTOP	Tube

Contents

1	Electrical ratings	3
2	Electrical characteristics	4
	2.1 Electrical characteristics (curves)	7
3	Test circuit	10
4	Package mechanical data	11
5	Revision History	13

1 Electrical ratings

Table 2. Absolute maximum ratings

Symbol	Parameter	Value	Unit
V _{CES}	Collector-emitter voltage (s _{GS} = 0)	600	V
I _C ⁽¹⁾	Collector current (continuous) at T _C = 25°C	100	A
I _C ⁽¹⁾	Collector current (continuous) at T _C = 100°C	50	A
I _{CL} ⁽²⁾	Collector current (pulsed)	250	A
V _{GE}	Gate-emitter voltage	± 20	V
I _F	Diode RMS forward current at T _C =25°C	30	A
P _{TOT}	Total dissipation at T _C = 25°C	260	W
T _{stg}	Storage temperature	-55 to 150	°C
T _j	Operating junction temperature		

1. Calculated according to the iterative formula:

$$I_C(T_C) = \frac{T_{JMAX} - T_C}{R_{THJ-C} \times V_{CESAT(MAX)}(T_C, I_C)}$$

2. Pulse width limited by T_{jmax}

Table 3. Thermal resistance

Symbol	Parameter	Min	Typ	Max	Unit
R _{thj-case}	Thermal resistance junction-case (IGBT)	--	--	0.48	°C/W
R _{thj-case}	Thermal resistance junction-case (diode)	--	--	1.5	°C/W
R _{thj-amb}	Thermal resistance junction-amb	--	--	50	°C/W

2 Electrical characteristics

($T_J = 25\text{ °C}$ unless otherwise specified)

Table 4. Static

Symbol	Parameter	Test conditions	Min.	Typ.	Max.	Unit
$V_{BR(CES)}$	Collector-emitter breakdown voltage	$I_C = 1\text{ mA}$, $V_{GE} = 0$	600			V
$V_{CE(sat)}$	Collector-emitter saturation voltage	$V_{GE} = 15\text{ V}$, $I_C = 40\text{ A}$ $V_{GE} = 15\text{ V}$, $I_C = 40\text{ A}$, $T_C = 125\text{ °C}$		2.1 1.9	2.6	V V
$V_{GE(th)}$	Gate threshold voltage	$V_{CE} = V_{GE}$, $I_C = 250\text{ }\mu\text{A}$	3.75		5.75	V
I_{CES}	Collector cut-off current ($V_{GE} = 0$)	$V_{CE} = \text{Max rating}$, $T_C = 25\text{ °C}$ $V_{CE} = \text{Max rating}$, $T_C = 125\text{ °C}$			500 5	μA mA
I_{GES}	Gate-emitter leakage current ($V_{CE} = 0$)	$V_{GE} = \pm 20\text{ V}$, $V_{CE} = 0$			± 100	nA
g_{fs}	Forward transconductance	$V_{CE} = 15\text{ V}$, $I_C = 40\text{ A}$		25		S

Table 5. Dynamic

Symbol	Parameter	Test conditions	Min.	Typ.	Max.	Unit
C_{ies}	Input capacitance			4700		pF
C_{oes}	Output capacitance	$V_{CE} = 25\text{ V}$, $f = 1\text{ MHz}$,		410		pF
C_{res}	Reverse transfer capacitance	$V_{GE} = 0$		90		pF
Q_g	Total gate charge	$V_{CE} = 390\text{ V}$, $I_C = 40\text{ A}$,		195		nC
Q_{ge}	Gate-emitter charge	$V_{GE} = 15\text{ V}$,		32		nC
Q_{gc}	Gate-collector charge	Figure 17		82		nC

Table 6. Switching on/off (inductive load)

Symbol	Parameter	Test conditions	Min.	Typ.	Max.	Unit
$t_{d(on)}$	Turn-on delay time	$V_{CC} = 390V, I_C = 40A$		52		ns
t_r	Current rise time	$R_G = 3.3\Omega, V_{GE} = 15V,$		17		ns
$(di/dt)_{on}$	Turn-on current slope	<i>Figure 16, Figure 18</i>		2400		A/ μ s
$t_{d(on)}$	Turn-on delay time	$V_{CC} = 390V, I_C = 40A$		50		ns
t_r	Current rise time	$R_G = 3.3\Omega, V_{GE} = 15V,$		19		ns
$(di/dt)_{on}$	Turn-on current slope	$T_j = 125^\circ C$ <i>Figure 16, Figure 18</i>		2020		A/ μ s
$t_{r(Voff)}$	Off voltage rise time	$V_{CC} = 390V, I_C = 40A$		31		ns
$t_{d(Voff)}$	Turn-off delay time	$R_G = 3.3\Omega, V_{GE} = 15V,$		240		ns
t_f	Current fall time	<i>Figure 16, Figure 18</i>		35		ns
$t_{r(Voff)}$	Off voltage rise time	$V_{CC} = 390V, I_C = 40A$		59		ns
$t_{d(Voff)}$	Turn-off delay time	$R_G = 3.3\Omega, V_{GE} = 15V,$		280		ns
t_f	Current fall time	$T_j = 125^\circ C$ <i>Figure 16, Figure 18</i>		63		ns

Table 7. Switching energy (inductive load)

Symbol	Parameter	Test conditions	Min.	Typ.	Max.	Unit
$E_{on}^{(1)}$	Turn-on switching losses	$V_{CC} = 390V, I_C = 40A$		365	470	μ J
$E_{off}^{(2)}$	Turn-off switching losses	$R_G = 3.3\Omega, V_{GE} = 15V,$		560	790	μ J
E_{ts}	Total switching losses	<i>Figure 18</i>		925	1260	μ J
$E_{on}^{(1)}$	Turn-on switching losses	$V_{CC} = 390V, I_C = 40A$		635		μ J
$E_{off}^{(2)}$	Turn-off switching losses	$R_G = 3.3\Omega, V_{GE} = 15V,$		910		μ J
E_{ts}	Total switching losses	$T_j = 125^\circ C$ <i>Figure 18</i>		1545		μ J

1. E_{on} is the turn-on losses when a typical diode is used in the test circuit in *Figure 18*. If the IGBT is offered in a package with a co-pak diode, the co-pak diode is used as external diode. IGBTs & Diode are at the same temperature (25°C and 125°C)
2. Turn-off losses include also the tail of the collector current

Table 8. Collector-emitter diode

Symbol	Parameter	Test conditions	Min.	Typ.	Max.	Unit
V_f	Forward on-voltage	$I_f = 15A$		1.5	2.9	V
		$I_f = 15A, T_j = 125^\circ C$		1.2		V
		$I_f = 40A, T_j = 125^\circ C$		1.35		V
t_{rr}	Reverse recovery time	$I_f = 40A, V_R = 50V,$ $T_j = 25^\circ C, di/dt = 100 A/\mu s$ <i>Figure 19</i>		55		ns
Q_{rr}	Reverse recovery charge			100		nC
I_{rrm}	Reverse recovery current			3.6		A
t_{rr}	Reverse recovery time	$I_f = 40A, V_R = 50V,$ $T_j = 125^\circ C, di/dt = 100A/\mu s$ <i>Figure 19</i>		164		ns
Q_{rr}	Reverse recovery charge			525		nC
I_{rrm}	Reverse recovery current			6.4		A

2.1 Electrical characteristics (curves)

Figure 2. Output characteristics

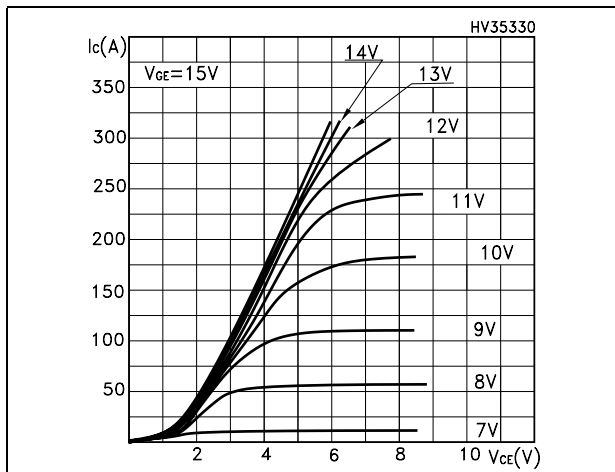

Figure 3. Transfer characteristics

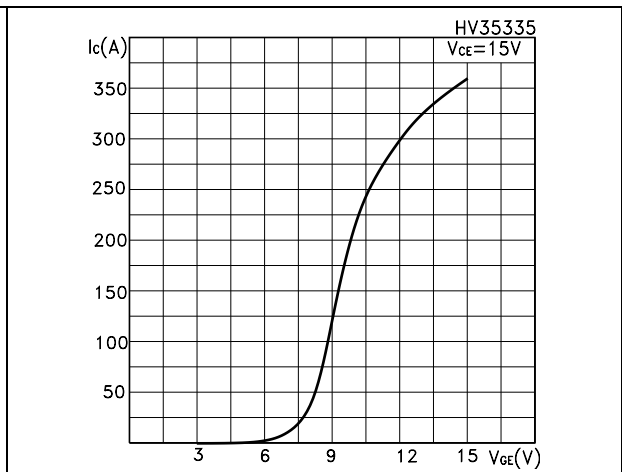

Figure 4. Transconductance

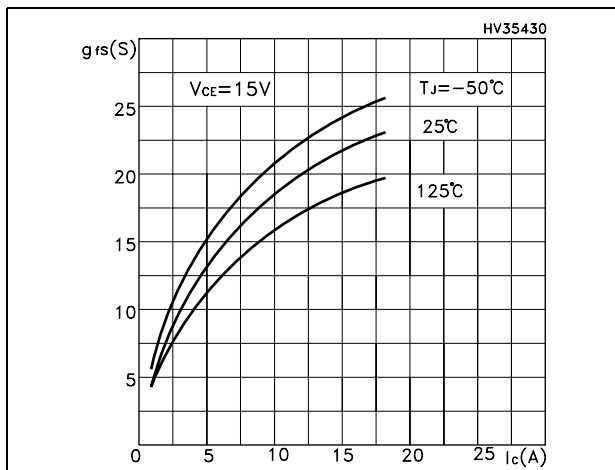

Figure 5. Collector-emitter on voltage vs temperature

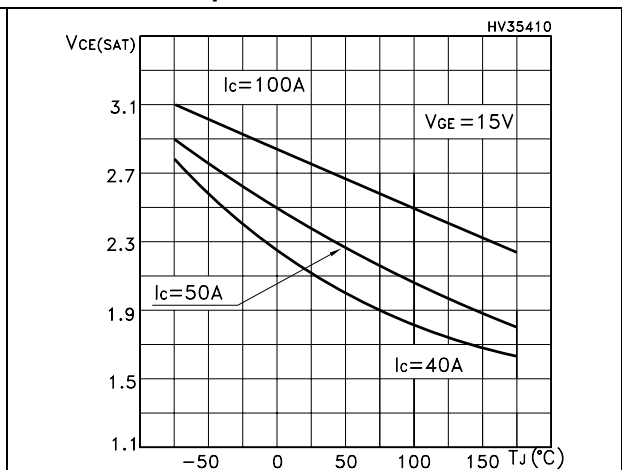

Figure 6. Gate charge vs gate-source voltage

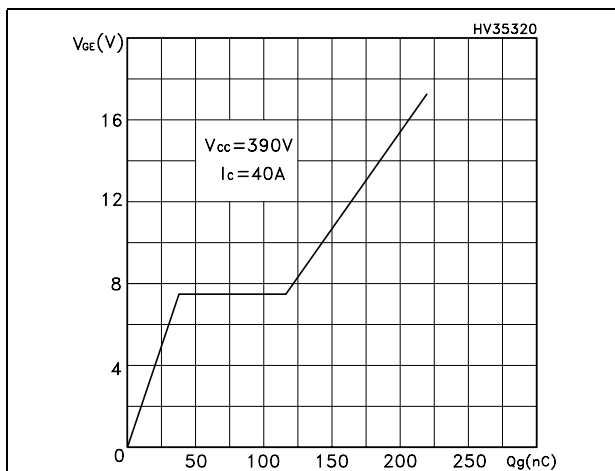

Figure 7. Capacitance variations

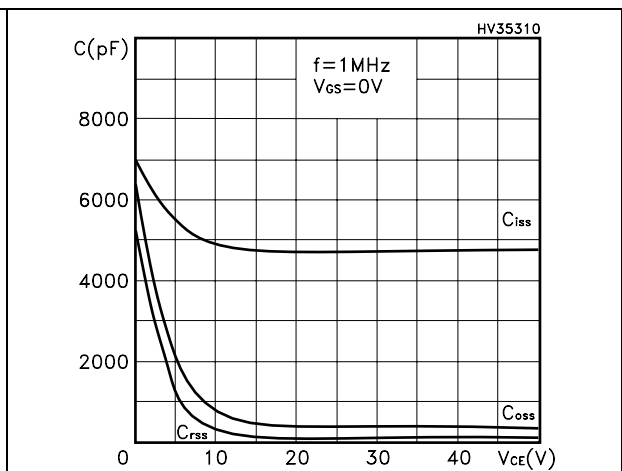

Figure 8. Normalized gate threshold voltage vs temperature

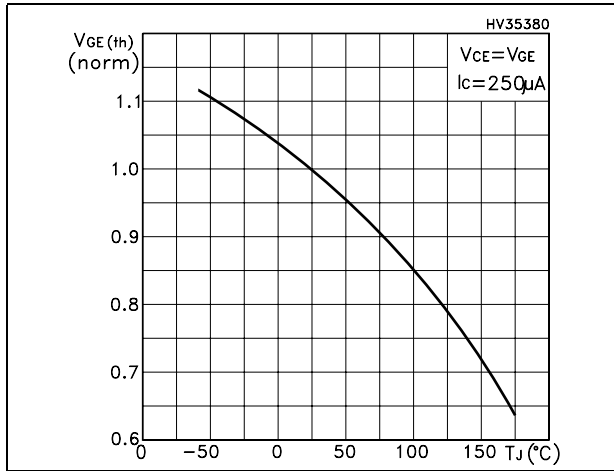

Figure 9. Collector-emitter on voltage vs collector current

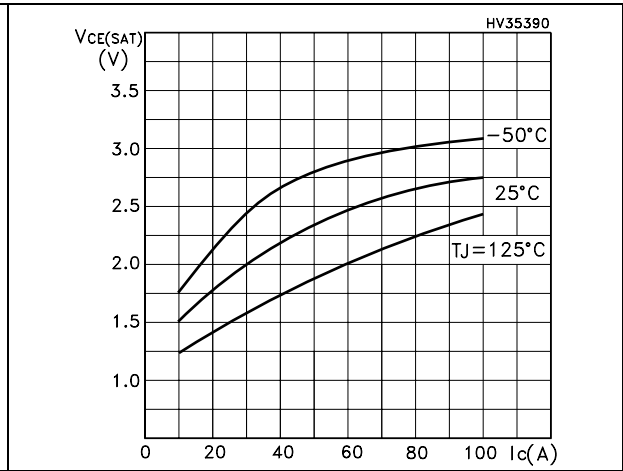

Figure 10. Normalized breakdown voltage vs temperature

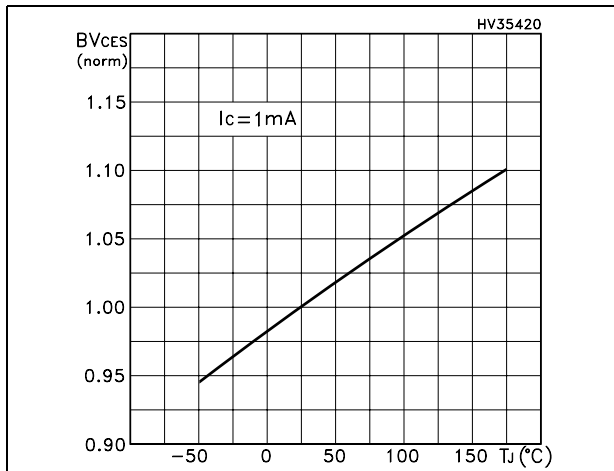

Figure 11. Switching losses vs temperature

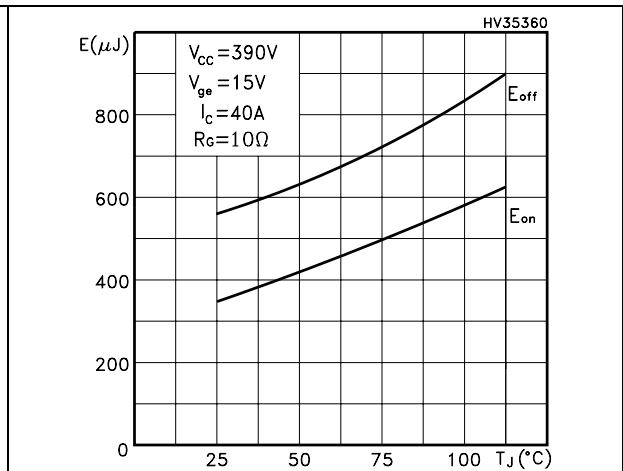

Figure 12. Switching losses vs gate resistance

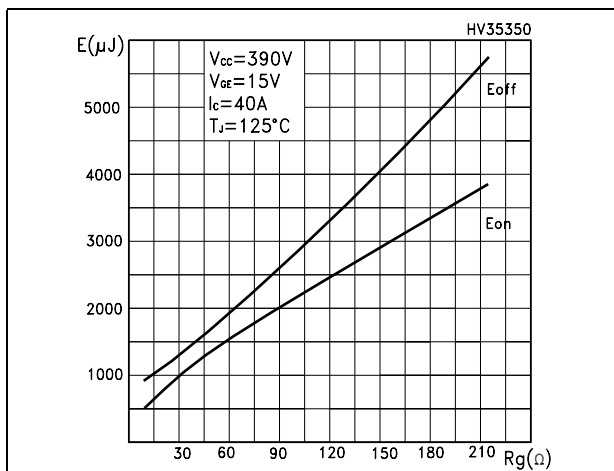

Figure 13. Switching losses vs collector current

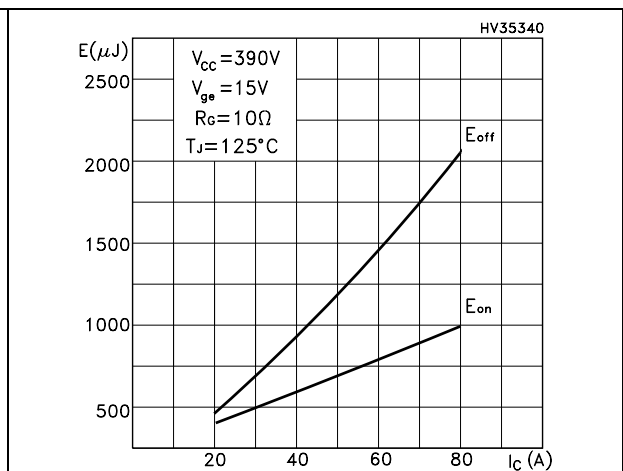

Figure 14. Turn-off SOA

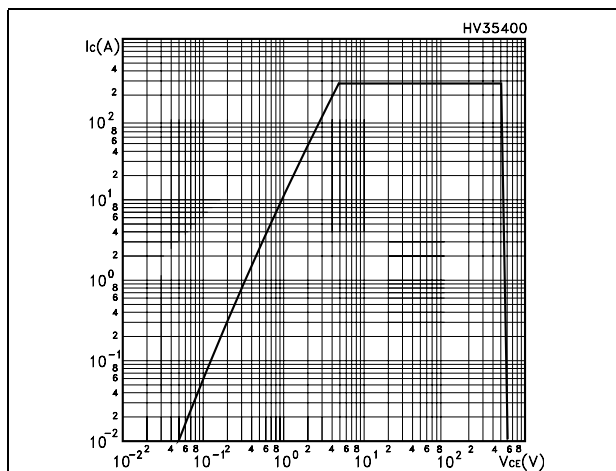
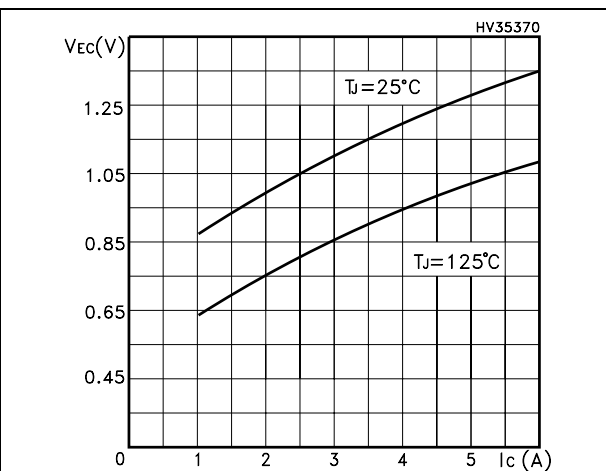

Figure 15. Emitter-collector diode characteristics



3 Test circuit

Figure 16. Test circuit for inductive load switching

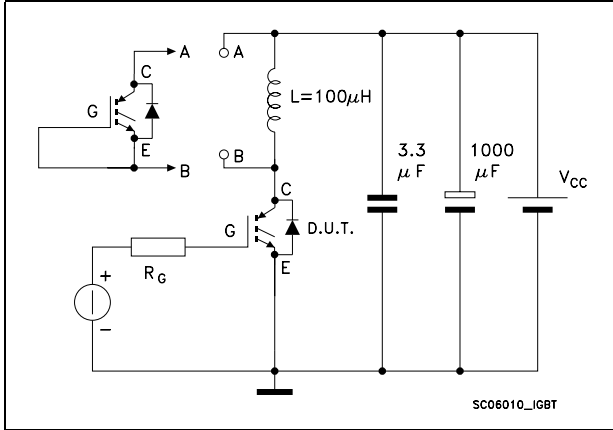

Figure 17. Gate charge test circuit

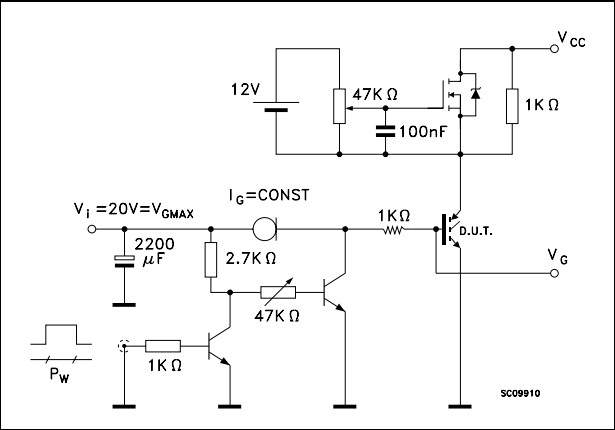

Figure 18. Switching waveform

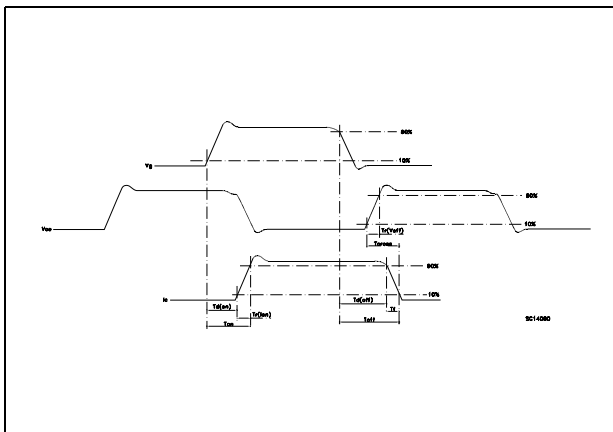
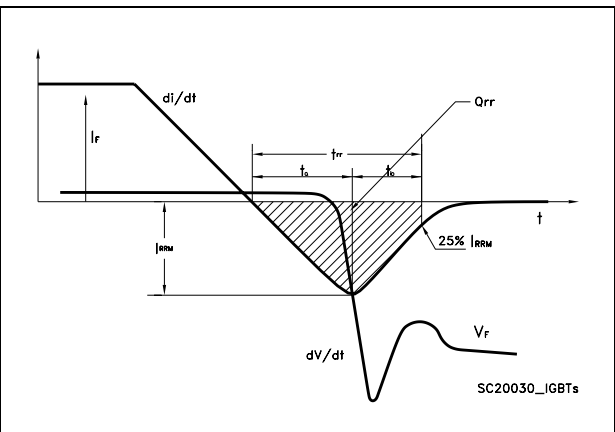

Figure 19. Diode recovery time waveform



4 Package mechanical data

In order to meet environmental requirements, ST offers these devices in ECOPACK® packages. These packages have a Lead-free second level interconnect. The category of second level interconnect is marked on the package and on the inner box label, in compliance with JEDEC Standard JESD97. The maximum ratings related to soldering conditions are also marked on the inner box label. ECOPACK is an ST trademark. ECOPACK specifications are available at: www.st.com

ISOTOP MECHANICAL DATA

DIM.	mm			inch		
	MIN.	TYP.	MAX.	MIN.	TYP.	MAX.
A	11.8		12.2	0.466		0.480
B	8.9		9.1	0.350		0.358
C	1.95		2.05	0.076		0.080
D	0.75		0.85	0.029		0.033
E	12.6		12.8	0.496		0.503
F	25.15		25.5	0.990		1.003
G	31.5		31.7	1.240		1.248
H	4			0.157		
J	4.1		4.3	0.161		0.169
K	14.9		15.1	0.586		0.594
L	30.1		30.3	1.185		1.193
M	37.8		38.2	1.488		1.503
N	4			0.157		
O	7.8		8.2	0.307		0.322

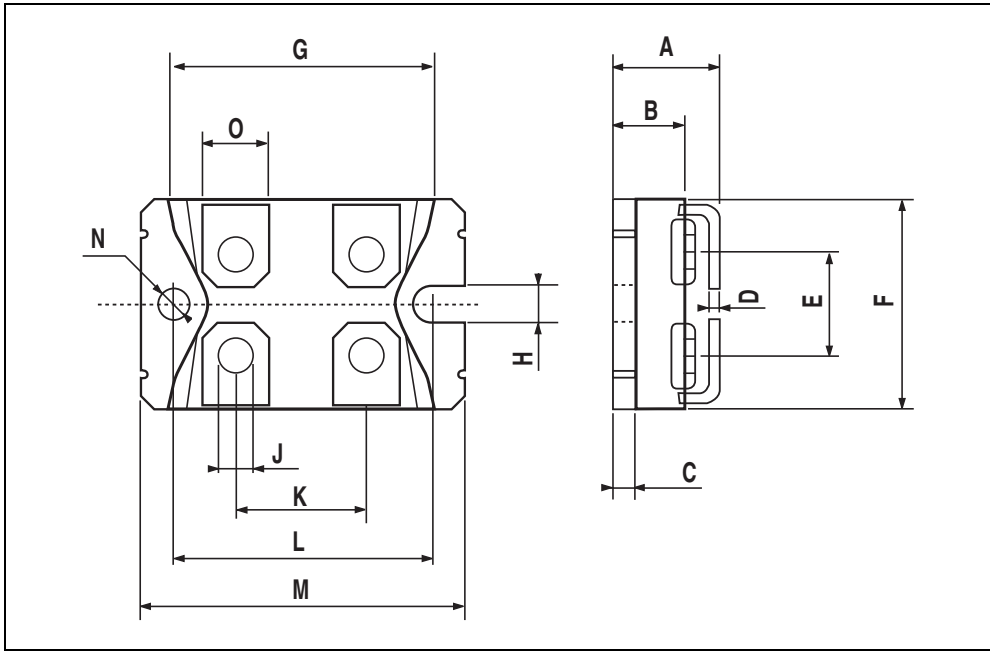

5 Revision History

Table 9. Revision history

Date	Revision	Changes
07-May-2006	1	First release
24-Jul-2007	2	New Figure 1: Internal schematic diagram

Please Read Carefully:

Information in this document is provided solely in connection with ST products. STMicroelectronics NV and its subsidiaries ("ST") reserve the right to make changes, corrections, modifications or improvements, to this document, and the products and services described herein at any time, without notice.

All ST products are sold pursuant to ST's terms and conditions of sale.

Purchasers are solely responsible for the choice, selection and use of the ST products and services described herein, and ST assumes no liability whatsoever relating to the choice, selection or use of the ST products and services described herein.

No license, express or implied, by estoppel or otherwise, to any intellectual property rights is granted under this document. If any part of this document refers to any third party products or services it shall not be deemed a license grant by ST for the use of such third party products or services, or any intellectual property contained therein or considered as a warranty covering the use in any manner whatsoever of such third party products or services or any intellectual property contained therein.

UNLESS OTHERWISE SET FORTH IN ST'S TERMS AND CONDITIONS OF SALE ST DISCLAIMS ANY EXPRESS OR IMPLIED WARRANTY WITH RESPECT TO THE USE AND/OR SALE OF ST PRODUCTS INCLUDING WITHOUT LIMITATION IMPLIED WARRANTIES OF MERCHANTABILITY, FITNESS FOR A PARTICULAR PURPOSE (AND THEIR EQUIVALENTS UNDER THE LAWS OF ANY JURISDICTION), OR INFRINGEMENT OF ANY PATENT, COPYRIGHT OR OTHER INTELLECTUAL PROPERTY RIGHT.

UNLESS EXPRESSLY APPROVED IN WRITING BY AN AUTHORIZED ST REPRESENTATIVE, ST PRODUCTS ARE NOT RECOMMENDED, AUTHORIZED OR WARRANTED FOR USE IN MILITARY, AIR CRAFT, SPACE, LIFE SAVING, OR LIFE SUSTAINING APPLICATIONS, NOR IN PRODUCTS OR SYSTEMS WHERE FAILURE OR MALFUNCTION MAY RESULT IN PERSONAL INJURY, DEATH, OR SEVERE PROPERTY OR ENVIRONMENTAL DAMAGE. ST PRODUCTS WHICH ARE NOT SPECIFIED AS "AUTOMOTIVE GRADE" MAY ONLY BE USED IN AUTOMOTIVE APPLICATIONS AT USER'S OWN RISK.

Resale of ST products with provisions different from the statements and/or technical features set forth in this document shall immediately void any warranty granted by ST for the ST product or service described herein and shall not create or extend in any manner whatsoever, any liability of ST.

ST and the ST logo are trademarks or registered trademarks of ST in various countries.

Information in this document supersedes and replaces all information previously supplied.

The ST logo is a registered trademark of STMicroelectronics. All other names are the property of their respective owners.

© 2007 STMicroelectronics - All rights reserved

STMicroelectronics group of companies

Australia - Belgium - Brazil - Canada - China - Czech Republic - Finland - France - Germany - Hong Kong - India - Israel - Italy - Japan - Malaysia - Malta - Morocco - Singapore - Spain - Sweden - Switzerland - United Kingdom - United States of America

www.st.com