

This material and the information herein is the property of Fuji Electric Co., Ltd.
 They shall be neither reproduced, copied, lent, or disclosed in any way whatsoever for
 the use of any third party nor used for the manufacturing purposes without the express
 written consent of Fuji Electric Co., Ltd.

SPECIFICATION

Device Name	:	IGBT-IPM (RoHS compliant product)
Type Name	:	7MBP50VDA060-50
Spec. No.	:	MS6M1427

REVISIONS	DATE	NAME	APPROVED				
	Aug. 5, 2011	Y. Yasuda	O. Ikawa	Fuji Electric Co., Ltd.			
	Aug. 5, 2011	M. Watanabe					
	Aug. 5, 2011	K. Oshika					

DWG. NO.	MS6M1427		1/26		a	

Revised Records

Date	Classi- fication	Ind.	Content	Applied date	Drawn	Checked	Checked	Approved
Aug. 5 ,2011	Enactment	-	-	Issued date	Y.Yasuda	M.Watanabe	K.Oshika	O.Ikawa
Sep. 29 ,2011	Revise Addition	a	Revise:Package Outline Drawings(3/26) Figure2 (9/26) Truth table (12/26) Addition:Switching frequency of IPM (8/26)	Sep. 29 ,2011	T.Yamamura	M.Watanabe	K. Oshika	O. Ikawa

This material and the information herein is the property of Fuji Electric Co., Ltd.
 They shall be neither reproduced, copied, lent, or disclosed in any way whatsoever for
 the use of any third party nor used for the manufacturing purposes without the express
 written consent of Fuji Electric Co., Ltd.

1. Package Outline Drawings

(Tc=25)

Package type : P630

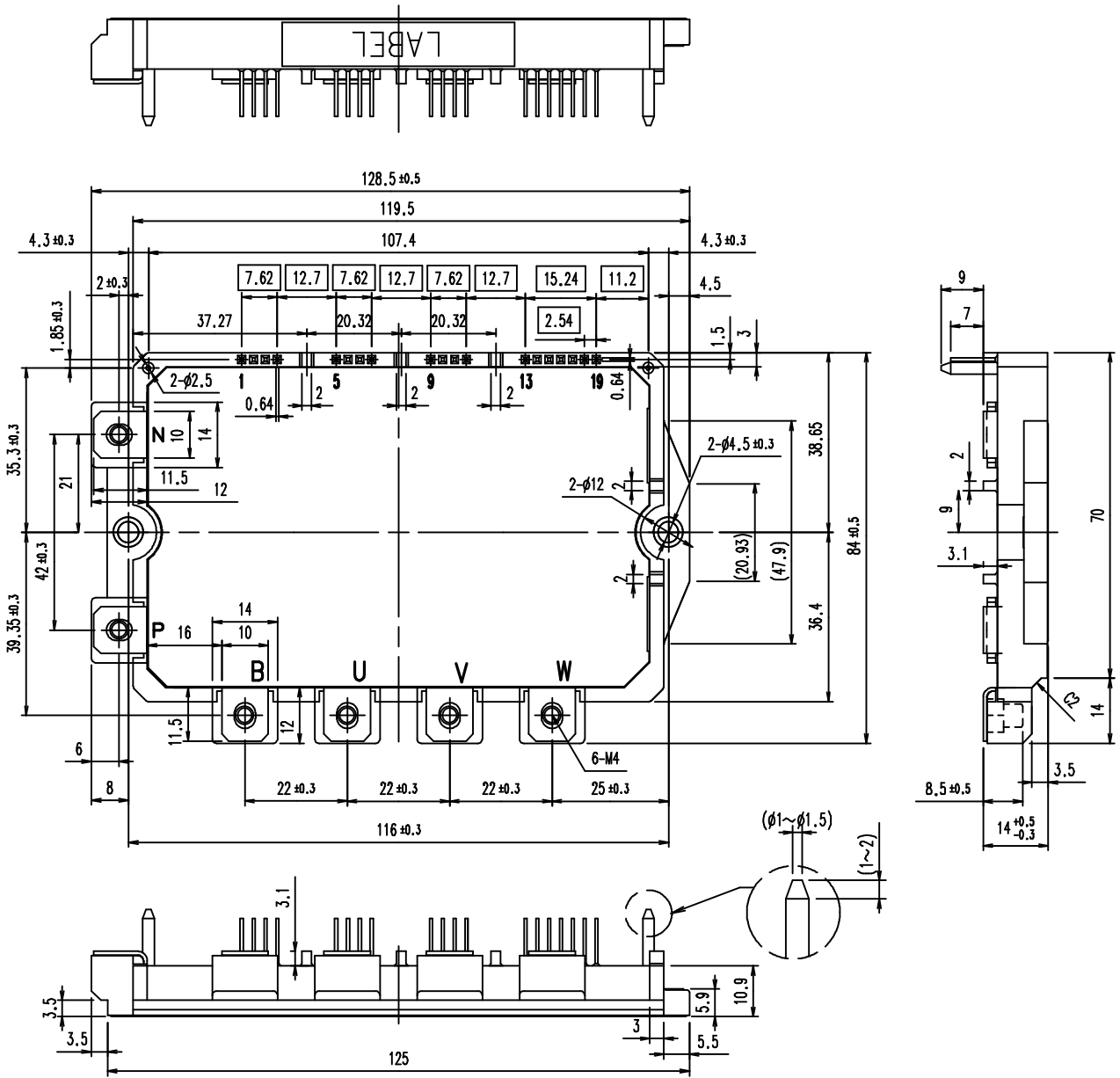

This material and the information herein is the property of Fuji Electric Co., Ltd.
 They shall be neither reproduced, copied, lent, or disclosed in any way whatsoever for
 the use of any third party nor used for the manufacturing purposes without the express
 written consent of Fuji Electric Co., Ltd.

Indication on module (モジュール表示)

Display on module label

- Logo of production
- Type name : 7MBP50VDA060-50
- Ic, VCES rating 50A 600V
- Lot No. (5digits)
- Place of manufacturing (code)
- Data matrix

Indication of Lot No.

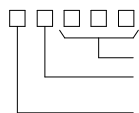

Odered No. in monthly
 Manufactured month
 (Jan. ~ Sep. : 1 ~ 9, Oct:O, Nov.:N, Dec.:D)
 Last digit of manufactured year

注)

- Note
1. は理論寸法を示す。
" " shows theoretical dimension.
 2. 端子ピッチは根元寸法とする。
The dimensions of the terminals are defined at the bottom.
 3. ()内寸法は、参考値とする。
"()" shows reference dimension.
 4. 主端子 : Niめっき
Main terminal : Ni plating
制御端子 : 下地Ni + 表面Auめっき
Control terminal : Au plating on Ni plating

[Dimensions in mm]

Fuji Electric Co., Ltd.

DWG. NO.

MS6M1427

3/26

a

2. Pin Descriptions

2.1 Main circuit

Symbol	Description
P	Positive input supply voltage.
U	Output (U).
V	Output (V).
W	Output (W).
N	Negative input supply voltage.
B	Collector terminal of Brake IGBT.

2.1 Control circuit

No.	Symbol	Description
	GNDU	High side ground (U).
	ALMU	Alarm signal output (U).
	VinU	Logic input for IGBT gate drive (U).
	VCCU	High side supply voltage (U).
	GNDV	High side ground (V).
	ALMV	Alarm signal output (V).
	VinV	Logic input for IGBT gate drive (V).
	VCCV	High side supply voltage (V).
	GNDW	High side ground (W).
	ALMW	Alarm signal output (W).
	VinW	Logic input for IGBT gate drive (W).
	VCCW	High side supply voltage (W).
	GND	Low side ground.
	VCC	Low side supply voltage.
	VinDB	Logic input for Brake IGBT gate drive.
	VinX	Logic input for IGBT gate drive (X).
	VinY	Logic input for IGBT gate drive (Y).
	VinZ	Logic input for IGBT gate drive (Z).
	ALM	Low side alarm signal output.

This material and the information herein is the property of Fuji Electric Co.,Ltd.
 They shall be neither reproduced, copied, lent, or disclosed in any way whatsoever for
 the use of any third party nor used for the manufacturing purposes without the express
 written consent of Fuji Electric Co.,Ltd.

3. Block Diagram

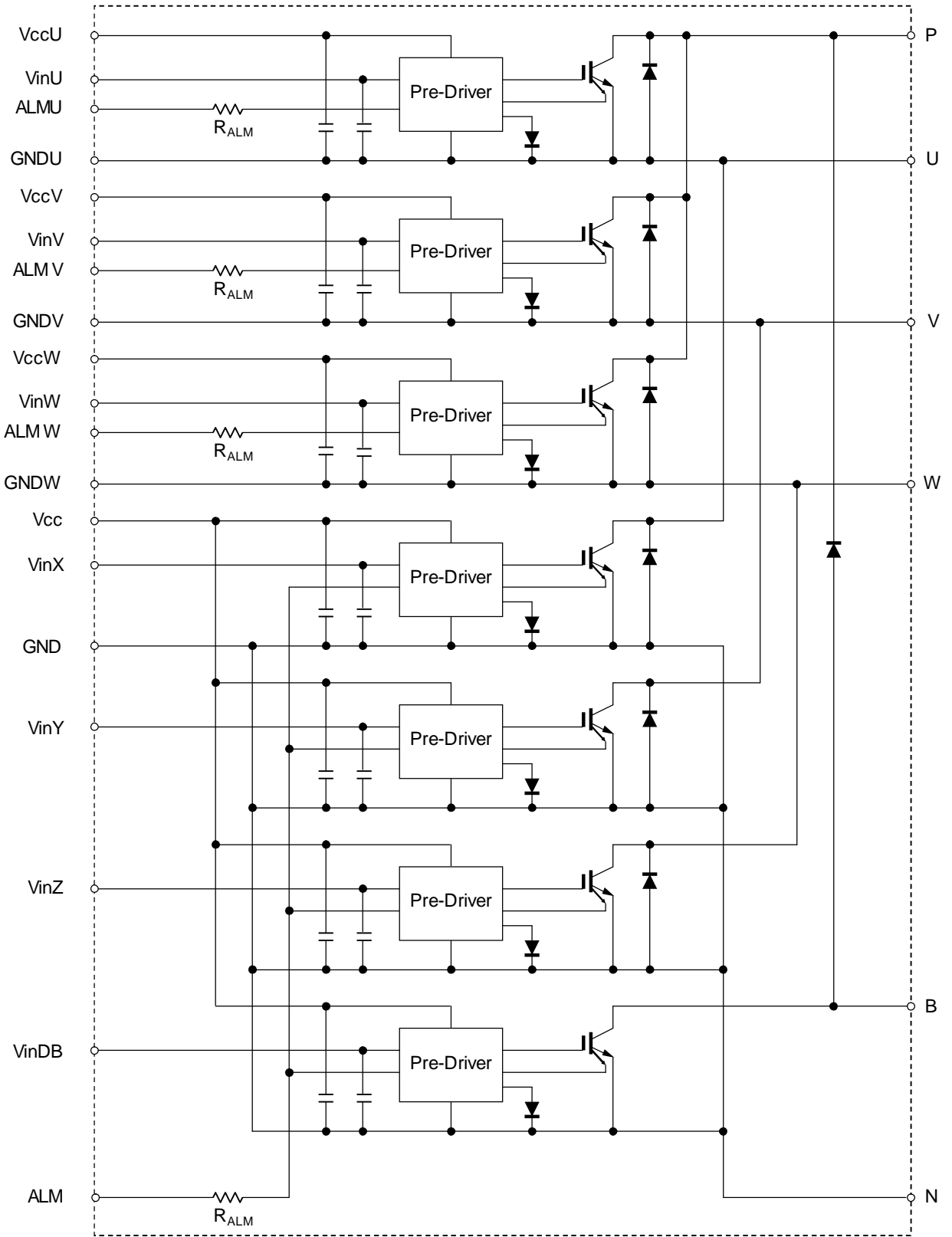

Pre-drivers include following functions

1. Amplifier for driver
2. Short circuit protection
3. Under voltage lockout circuit
4. Over current protection
5. IGBT chip over heating protection

This material and the information herein is the property of Fuji Electric Co., Ltd. They shall be neither reproduced, copied, lent, or disclosed in any way whatsoever for the use of any third party nor used for the manufacturing purposes without the express written consent of Fuji Electric Co., Ltd.

4. Absolute Maximum Ratings

Tc = 25 , Vcc = 15V unless otherwise specified.

Items		Symbol	Min.	Max.	Units	
Collector-Emitter Voltage *1		V _{CES}	0	600	V	
Short Circuit Voltage		V _{SC}	200	400	V	
Inverter	Collector Current	DC	I _C	-	50	A
		1ms	I _{CP}	-	100	A
	Duty=100% *2	-I _C	-	50	A	
Collector Power Dissipation		1 device *3	P _C	-	201	W
Brake	Collector Current	DC	I _C	-	30	A
		1ms	I _{CP}	-	60	A
	Forward Current of Diode		I _F	-	30	A
Collector Power Dissipation		1 device *3	P _C	-	126	W
Supply Voltage of Pre-Driver *4		V _{CC}	-0.5	20	V	
Input Signal Voltage *5		V _{in}	-0.5	V _{CC} +0.5	V	
Alarm Signal Voltage *6		V _{ALM}	-0.5	V _{CC}	V	
Alarm Signal Current *7		I _{ALM}	-	20	mA	
Junction Temperature		T _j	-	150		
Operating Case Temperature		T _{opr}	-20	110		
Storage Temperature		T _{stg}	-40	125		
Solder Temperature *8		T _{sol}	-	260		
Isolating Voltage *9		V _{iso}	-	AC2500	V _{rms}	
Screw Torque	Terminal (M4)	-	-	1.7	Nm	
	Mounting (M4)					

Notes

- *1: V_{CES} shall be applied to the input voltage between terminal P-(U,V,W,B) and (U,V,W,B)-N.
- *2: Duty=125 /R_{th(j-c)}D/(I_F×V_F Max.)×100
- *3: P_C=125 /R_{th(j-c)}Q (Inverter & Brake)
- *4: V_{CC} shall be applied to the input voltage between terminal No.4 and 1, 8 and 5, 12 and 9, 14 and 13.
- *5: V_{in} shall be applied to the input voltage between terminal No.3 and 1, 7 and 5, 11 and 9, 15~18 and 13.
- *6: V_{ALM} shall be applied to the voltage between terminal No.2 and 1, 6 and 5, 10 and 9, 19 and 13.
- *7: I_{ALM} shall be applied to the input current to terminal No.2,6,10 and 19.
- *8: Immersion time 10±1sec. 1 time
- *9: Terminal to base, 50/60Hz sine wave 1min. All terminals should be connected together during the test.

This material and the information herein is the property of Fuji Electric Co.,Ltd. They shall be neither reproduced, copied, lent, or disclosed in any way whatsoever for the use of any third party nor used for the manufacturing purposes without the express written consent of Fuji Electric Co.,Ltd.

5. Electrical Characteristics

$T_j = 25$, $V_{CC} = 15V$ unless otherwise specified.

5.1 Main circuit

Item		Symbol	Conditions	Min.	Typ.	Max.	Units	
Inverter	Collector Current at off signal input	ICES	$V_{CE}=600V$	-	-	1.0	mA	
	Collector-Emitter saturation voltage	$V_{CE(sat)}$	$I_C=50A$ Fig.4	Terminal	-	-	1.95	V
				Chip	-	1.40	-	V
	Forward voltage of FWD	V_F	$I_F=50A$ Fig.5	Terminal	-	-	2.35	V
				Chip	-	1.80	-	V
	Brake	Collector Current at off signal input	ICES	$V_{CE}=600V$	-	-	1.0	mA
Collector-Emitter saturation voltage		$V_{CE(sat)}$	$I_C=30A$ Fig.4	Terminal	-	-	1.85	V
				Chip	-	1.40	-	V
Forward voltage of FWD		V_F	$I_F=30A$ Fig.5	Terminal	-	-	2.20	V
				Chip	-	1.80	-	V
Switching time		t_{on}	$V_{DC}=300V, T_j=125$		1.1	-	-	μs
	t_{off}	$I_C=50A$	Fig.1,6	-	-	2.1	μs	
	t_{tr}	$V_{DC}=300V$ $I_C=50A$ Fig.1,6		-	-	0.3	μs	

5.2 Control circuit

Item	Symbol	Conditions	Min.	Typ.	Max.	Units	
Supply current of P-side pre-driver (per one unit)	I_{ccp}	Switching Frequency = 0-15kHz	-	-	12	mA	
Supply current of N-side pre-driver	I_{ccn}	$T_c=-20 \sim 110$ Fig.7	-	-	46	mA	
Input signal threshold voltage	$V_{in(th)(on)}$	V_{in-GND}	ON	1.2	1.4	1.6	V
	$V_{in(th)(off)}$		OFF	1.5	1.7	1.9	V

5.3 Protection Circuit

Item	Symbol	Conditions	Min.	Typ.	Max.	Units	
Over Current Protection Level	Inverter	$T_j=125$ Fig.3	75	-	-	A	
	Brake		45	-	-	A	
Over Current Protection Delay time	t_{dOC}	$T_j=125$, Fig.3	-	5	-	μs	
Short Circuit Protection Delay time	t_{SC}	$T_j=125$, Fig.8	-	2	3	μs	
IGBT Chips Over Heating Protection Temperature Level	T_{jOH}	Surface of IGBT Chips	150	-	-		
Over Heating Protection Hysteresis	T_{jH}		-	20	-		
Under Voltage Protection Level	V_{UV}		11.0	-	12.5	V	
Under Voltage Protection Hysteresis	V_H		0.2	0.5	-	V	
Alarm Signal Hold Time	$t_{ALM(OC)}$	ALM-GND	1.0	2.0	2.4	ms	
	$t_{ALM(UV)}$	$T_c=-20 \sim 110$ Fig.2	$V_{CC} 10V$	2.5	4.0	4.9	ms
	$t_{ALM(T_{jOH})}$			5.0	8.0	11.0	ms
Resistance for current limit	RALM		960	1265	1570	Ω	

Fuji Electric Co.,Ltd.

DWG.NO.

MS6M1427

7/26

a

6. Thermal Characteristics (Tc = 25)

Item		Symbol	Min.	Typ.	Max.	Units	
Junction to Case Thermal Resistance*10	Inverter	IGBT	Rth(j-c)Q	-	-	0.62	/W
		FWD	Rth(j-c)D	-	-	0.98	/W
	Brake	IGBT	Rth(j-c)Q	-	-	0.99	/W
		FWD	Rth(j-c)D	-	-	1.38	/W
Case to Fin Thermal Resistance with Compound			Rth(c-f)	-	0.05	-	/W

*10: For 1device , the measurement point of the case is just under the chip.

Chip layout drawing

Package : P630

Type name : 7MBP50VDA060-50

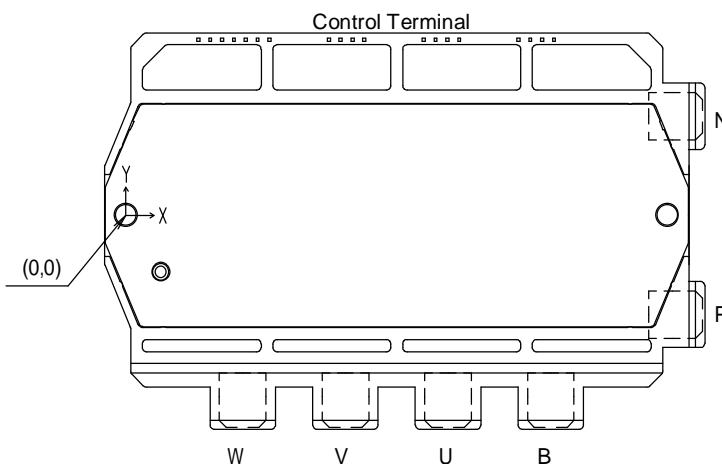

P630 Bottom view

Location of measurement of Tc (chip center right under)

Element Axis	U		V		W		X		Y		Z	
	IGBT	FWD	IGBT	FWD	IGBT	FWD	IGBT	FWD	IGBT	FWD	IGBT	FWD
X	80.4	79.7	53.4	54.1	38.2	38.5	69.6	71.9	47.0	46.3	31.4	30.7
Y	5.0	-3.2	5.9	-2.2	5.9	-2.2	-12.0	-4.0	-13.0	-4.9	-13.0	-4.9

Element Axis	B	
	IGBT	FWD
X	84.4	90.5
Y	-12.8	-1.4

(Unit: mm)

7. Noise Immunity (VDC=300V, VCC=15V, Test Circuit Figure 9.)

Item	Conditions	Min.	Typ.	Max.	Units
Common mode rectangular noise	Pulse width 1μs, polarity ±, 10 min. Judge: no over-current, no miss operating	±2.0	-	-	kV

8. Recommended Operating Conditions

Item	Symbol	Min.	Typ.	Max.	Units
DC Bus Voltage	Vdc	-	-	400	V
Power Supply Voltage of Pre-Driver	Vcc	13.5	15.0	16.5	V
Switching frequency of IPM	fsw	-	-	20	kHz
Arm shoot through blocking time for IPM's input signal	tdead	1.0	-	-	μs
Screw Torque (M4)	-	1.3	-	1.7	Nm

9. Weight

Item	Symbol	Min.	Typ.	Max.	Units
Weight	Wt	-	290	-	g

This material and the information herein is the property of Fuji Electric Co., Ltd. They shall be neither reproduced, copied, lent, or disclosed in any way whatsoever for the use of any third party nor used for the manufacturing purposes without the express written consent of Fuji Electric Co., Ltd.

Fuji Electric Co., Ltd.

DWG. NO.

MS6M1427

8/26

a

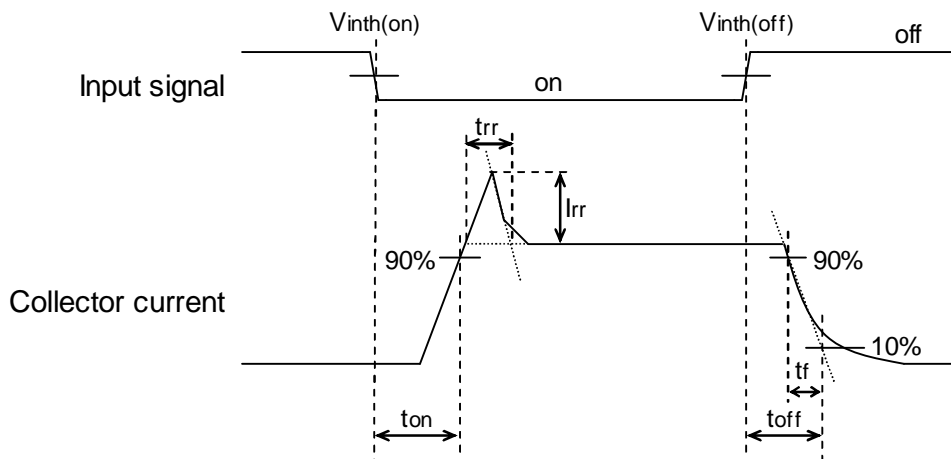

Figure1. Switching Time Waveform Definitions.

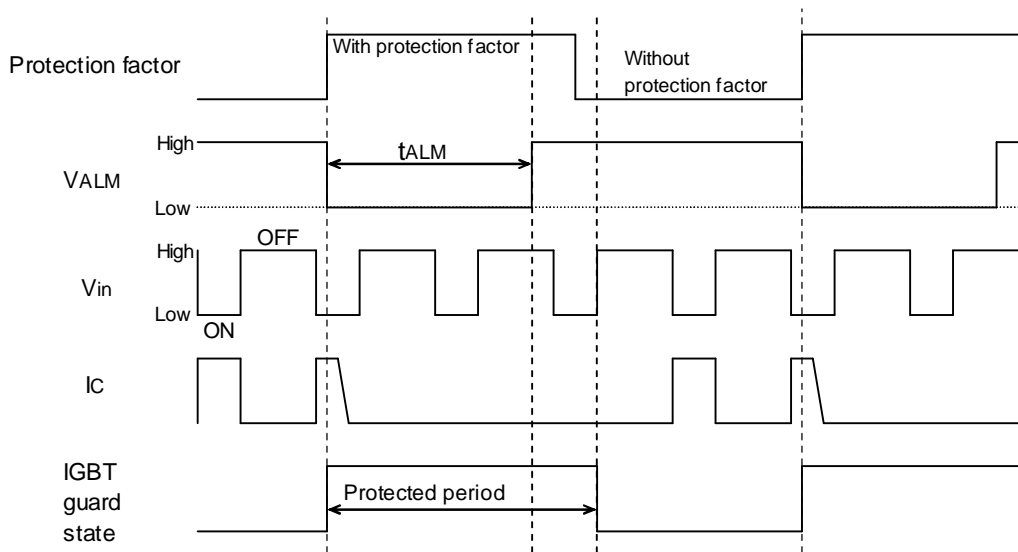

Figure2. Input/output Timing Diagram.

〔Alarm output〕〔アラーム出力〕

Set condition () : The alarm is output only once (High Low) according to timing when the protection factor occurs.

セット条件 () : 保護要因の発生したタイミングで、保護動作した相より1回のみアラーム出力 (High Low) されます。

Reset condition () : After it continues at the hold time of each alarm factor (t_{ALM}), it is released regardless of the presence of the alarm factor.

リセット条件 () : 要因毎の保持時間 (t_{ALM}) 継続後に 要因の有無に関係なく解除されます。

〔Protection operation (Switching stop of IGBT)〕〔保護動作 (IGBTのスイッチング停止)〕

Set condition () : The protection function operates when the protection factor occurs.

セット条件 () : 保護要因の発生とともに動作します。

Reset condition () : When the condition of protection factor cancellation, t_{ALM} passage, and input signal OFF becomes complete, the protection operation is released.

リセット条件 () : 保護要因解消, t_{ALM} 経過, 入力信号OFFの条件が揃った時に解除されます。

〔Condition that alarm is output again〕〔アラームが再出力される条件〕

The protection factor occurs again after the protection operation is reset, the protection function operates at the same time when the alarm is output. ()

保護動作がリセットされた後に再度保護要因が発生すれば、アラームが再出力されると同時に保護動作します ()。

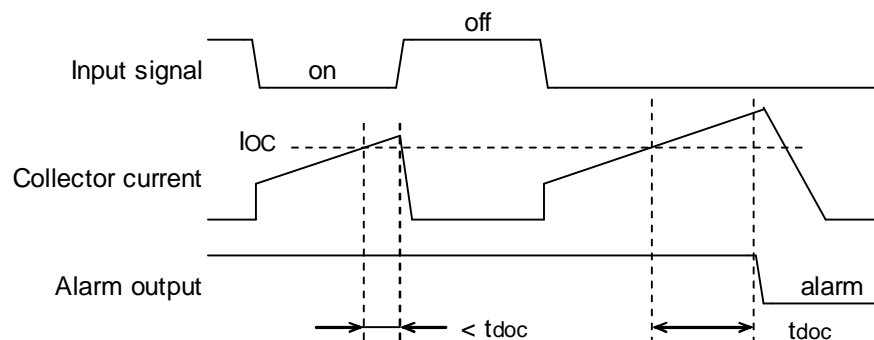

Figure3. Over Current Protection Timing Diagram.

Period : When a collector current over the OC level flows and the OFF command is input within a period less than the trip delay time t_{doc} , the current is hard-interrupted and no alarm is output.

期間 : OCレベルを超えたコレクタ電流が流れ、遮断遅れ時間 t_{doc} より短い時間内で、オフ指令が入力された場合は、電流をハード遮断しアラームは出力しません。

Period : When a collector current over the OC level flows for a period more than the trip delay time t_{doc} , the current is soft-interrupted and the alarm signals are outputted.

期間 : OCレベルを超えたコレクタ電流が、遮断遅れ時間 t_{doc} を超えた時間以上が流れ続けると電流をソフト遮断しアラームを出力します。

This material and the information herein is the property of Fuji Electric Co.,Ltd. They shall be neither reproduced, copied, lent, or disclosed in any way whatsoever for the use of any third party nor used for the manufacturing purposes without the express written consent of Fuji Electric Co.,Ltd.

This material and the information herein is the property of Fuji Electric Co., Ltd.
 They shall be neither reproduced, copied, lent, or disclosed in any way whatsoever for
 the use of any third party nor used for the manufacturing purposes without the express
 written consent of Fuji Electric Co., Ltd.

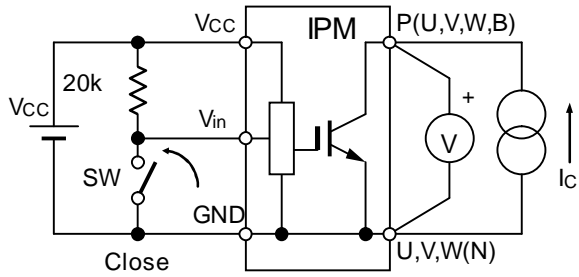

Figure4. VCE(sat) Test Circuit(Terminal)

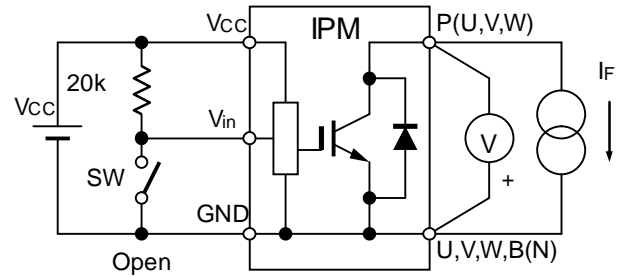

Figure5. VF Test Circuit(Terminal)

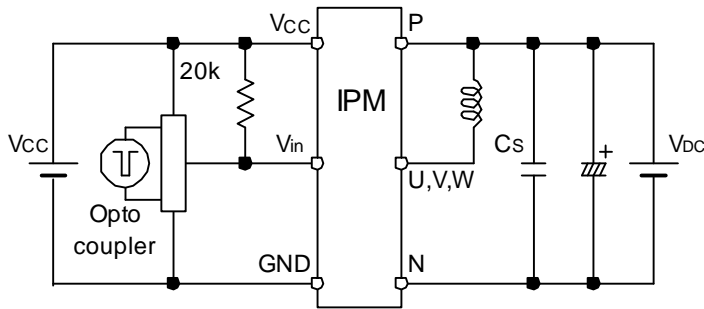

Figure6. Switching Characteristics Test Circuit

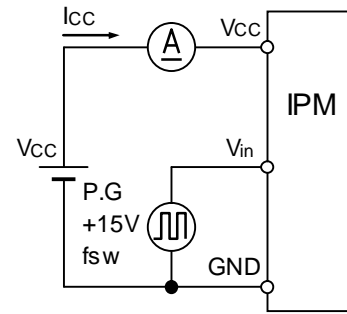

Figure7. Icc Test Circuit

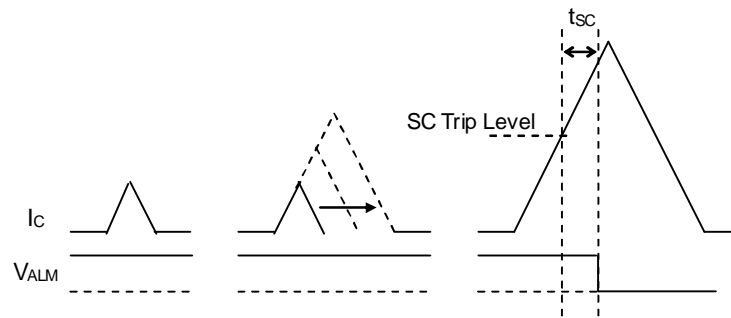

Figure8. Definition of tsc

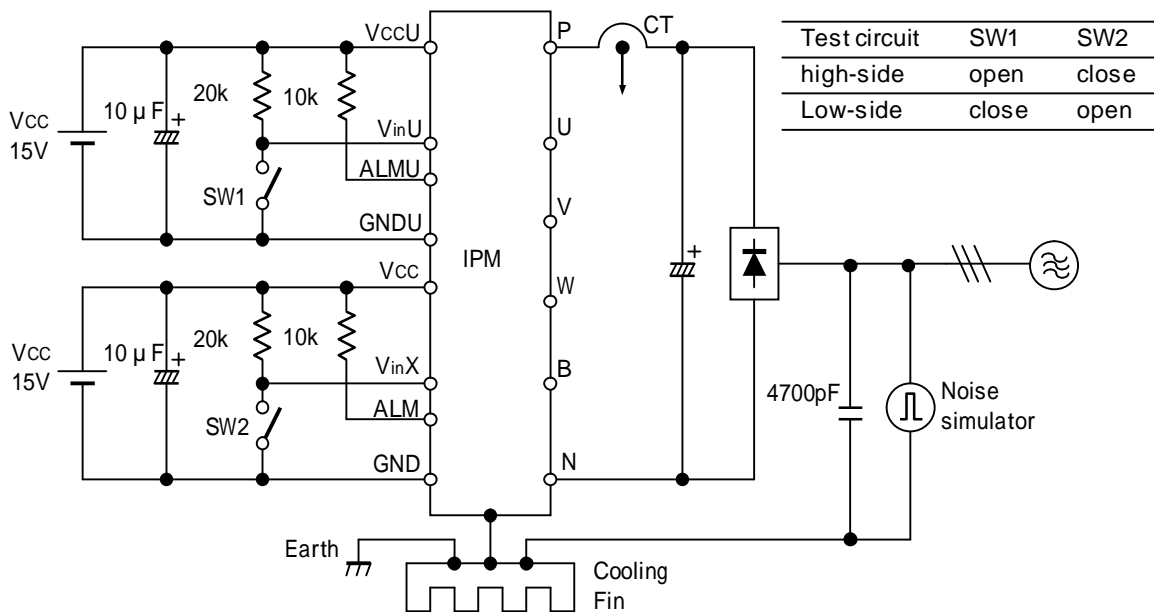

Figure9. Noise Test Circuit

10. Truth table

10.1 IGBT Control

The following table shows the IGBT ON/OFF status with respect to the input signal V_{in} .

The IGBT can be turned on when V_{in} is at "Low" level without the operation of IPM's protection.

入力信号 V_{in} に対するIGBTのON / OFF状態を下表に示します。

保護要因が無い状態において、 V_{in} が "Low" レベルで、IGBTはONします。

Input signal	IPM's Protection status	Output (IGBT)
Low	No operation	On
Low	Operation	Off
High	-	Off

10.2 Fault Detection

- (1) When a fault is detected at the high side, only the detected arm stops its output.

At that time the detected arm outputs an alarm.

上アームで異常を検出した場合、検出したアームのみ出力を停止します。

この場合、検出したアームはアラームを出力します。

- (2) When a fault is detected at the low side, all the lower arms stop their outputs and the alarm signals are outputted from lower arms.

下アーム回路で異常が発生した場合、

下アーム全ての出力を停止し、下アームからアラームを出力します。

- (3) An alarm is output only once. The output period is dependent on cause of fault.

アラームは1回のみ出力されます。また、出力期間 (t_{ALM}) は異常内容によって異なります。

	Cause of fault	Operation of IGBT				Alarm Output			
		U-phase	V-phase	W-phase	Low side	ALMU	ALMV	ALMW	ALM
High side U-phase	OC	OFF	*	*	*	L	H	H	H
	UV	OFF	*	*	*	L	H	H	H
	TjOH	OFF	*	*	*	L	H	H	H
High side V-phase	OC	*	OFF	*	*	H	L	H	H
	UV	*	OFF	*	*	H	L	H	H
	TjOH	*	OFF	*	*	H	L	H	H
High side W-phase	OC	*	*	OFF	*	H	H	L	H
	UV	*	*	OFF	*	H	H	L	H
	TjOH	*	*	OFF	*	H	H	L	H
Low side	OC	*	*	*	OFF	H	H	H	L
	UV	*	*	*	OFF	H	H	H	L
	TjOH	*	*	*	OFF	H	H	H	L

*: Depend on input logic.

H:High , L:Low

11. Recommendation for design and application

- (1) For the control power supply, secure the enough current capacity.
制御電源は、十分な電流容量を確保してください。
- (2) For the control power VCC, use four power supplies isolated each.
Connect the aluminum electrolytic capacitors (about 50V/10 μ F for upper arm and 50V/47 μ F for lower arm) as close as possible to the control power terminal VCC. These aluminum electrolytic capacitors are used not for smoothing the control power supply but for reducing the impedance of the external wiring.
Using single power supply such as bootstrap may occur the fluctuation of control power supply, so, it is necessary to design the systems considering these phenomenon in advance.
制御電源Vccは、絶縁された4電源を使用してください。
アルミ電解コンデンサ(上アーム:50V/10 μ F、下アーム:50V/47 μ F 程度)を、IPMの制御電源端子Vccに出来るだけ近接して実装してください。尚、本コンデンサは制御電源を平滑化する為のものではなく、IPMまでの配線インピーダンス補正用です。
ブートストラップ等の単電源での使用は、制御電圧変動等が予測される為、十分な検討、検証が必要です。
- (3) Don't apply noise current to the IPM's control GND line. It causes the malfunction.
IPMの制御GNDラインにノイズ電流を流さないでください。誤動作の原因となります。
- (4) At the external circuit, connections of GNDU to the main terminal U-phase, GNDV to V-phase, GNDW to W-phase, and GND to N-phase are prohibited. It causes the malfunction.
制御端子GNDUと主端子U、制御端子GNDVと主端子V、制御端子GNDWと主端子W、制御端子GNDと主端子Nを外部回路で接続しないで下さい。誤動作の原因になります。
- (5) In case of existence of disuse phase (ex. single phase use or disuse of DB phase), pull up the logic input and alarm signal output terminals of these disuse phase to VCC.
IPMを単相にて使用する場合や、ブレーキ内蔵タイプにてブレーキを使用しない場合は、使用しない相も制御電源を供給し、入力端子(Vin)、アラーム出力端子(ALM)共にVccへプルアップしてください。入力端子(Vin)オープン状態で制御電源を立ち上げた場合、アラーム出力状態となります。
- (6) In designing, make sure that the capacity of primary side current of optocoupler is enough, considering the CTR of optocoupler.
In case of the input forward current is not sufficient, input signals of IPM become instability and IPM may occur miss operation.
フォトカブラの一次側電流は、お使いのフォトカブラのCTRを考慮し十分に余裕をもった設計にして下さい。
一次電流が不足している場合、IPM入力信号が不安定となり、誤動作の原因となります。
- (7) To suppress the surge voltage, reduce the inductance at the DC bus of P-N circuit and connect some capacitors between the P and N terminals. Use capacitors with good high frequency characteristics.
P-N間の直流母線は出来るだけ低インダクタンス化し、P-N端子間にコンデンサを接続するなどしてサージ電圧を低減して下さい。
スナバコンデンサには高周波数特性の良いものを選んでください。
- (8) To estimate the chip temperature accurately, measure the case temperature just under the power chips and sum up the calculated ΔT_{j-c} to the case temperature.
チップ温度推定には、必ずチップ直下のケース温度を測定し、これに計算より求めた T_{j-c} を加えて行って下さい。
- (9) In case of mounting this product on cooling fin, use thermal compound to secure thermal conductivity. If the thermal compound amount was not enough or its applying method was not suitable, its spreading will not be enough, then, thermal conductivity will be worse and thermal run away destruction may occur. The recommended thickness of thermal compound is 100 μ m. In the applying, confirm the spreading state of thermal compound.
(Spreading state of the thermal compound can be confirmed by removing this product after mounting.)
素子を冷却フィンに取り付ける際には、熱伝導を確保するためのコンパウンド等をご使用ください。又、塗布量が不足したり、塗布方法が不適切な場合、コンパウンドが十分に素子全体に広がらず、放熱悪化による熱破壊に繋がる事があります。コンパウンドの塗布厚は100 μ mを推奨しますが、塗布する際には製品全面にコンパウンドが広がっている事を確認してください。
(実装した後に素子を取りはずすとコンパウンドの広がり具合を確認する事が出来ます。)

- (10) The assurance of solderability in control terminals is within once. Soldering in more than twice is out of quality assurance.
 本製品の制御端子部分のハンダ付け性保証回数は1回です。付け直し等による2回以上の回数のハンダ付け性は保証の対象外です。
- (11) This product is designed on the assumption that it applies to an inverter use. Sufficient examination is required at applying to a converter use. Please contact Fuji Electric Co.,Ltd if you would like to apply to converter use.
 本製品は、インバータ用途への適用を前提に設計されております。コンバータ用途へ適用される場合は、十分な検討が必要です。もし、コンバータへ適用される場合は御連絡ください。
- (12) Design the circuit pattern with shorter wiring from optocoupler to input signal terminals to reduce stray capacity in primary and secondary sides of optocoupler
 フォトカプラとIPMの入力端子間の配線は極力短くし、フォトカプラの一次側と二次側の浮遊容量を小さくしたパターンレイアウトにしてください。
- (13) A ceramic capacitor (about 0.1 μF) should be connected from pin VCC to GND to stabilize the operation of high speed optocoupler. The total lead length between capacitor and optocoupler is recommended within 1cm.
 フォトカプラの安定動作のため、VCC-GND間に0.1μF程度のセラミックコンデンサを接続してください。
 コンデンサとフォトカプラのループ配線長は、出来るだけ1cmを超えないようにしてください。
- (14) For the high-speed optocoupler, use high-CMR type with tpHL, tpLH 0.8 μs.
 高速フォトカプラは、tpHL, tpLH 0.8 μs、高CMRタイプをご使用ください。
- (15) For the alarm output circuit, use low-speed type optocoupler with CTR 100%.
 アラーム出力回路は、低速フォトカプラ CTR 100%のタイプをご使用ください。
- (16) Design the control board considering the external noise
 制御基板は、外来ノイズの影響を考慮した設計にしてください。
- (17) As connecting the capacitor between the input terminal and GND, the response time of secondary side of optocoupler will be delayed compared with the primary side input. So in designing, consider these points.
 入力端子-GND間にコンデンサを接続すると、フォトカブラ一次側入力信号に対する応答時間が長くなりますのでご注意ください。
- (18) To prevent noise intrusion from the AC lines, connect a capacitor of about 4700pF between the each three-phase lines and the ground.
 ACラインからのノイズ侵入を防ぐために、3相各線 - アース間に4700pF程度のコンデンサを接続してください。
- (19) Use this product with keeping the cooling fin's flatness between screw holes within 50 μm per 100mm and the roughness within 10 μm. Also keep the tightening torque within the limits of this specification. Too large convex of cooling fin may cause isolation breakdown and this may lead to a critical accident. On the other hand, too large concave of cooling fin makes gap between this product and the fin wider, then, thermal conductivity will be worse and over heat destruction may occur.
 冷却フィンにはネジ取り付け位置間で平坦度を100mmで50 μm以下、表面の粗さは10 μm以下を推奨します。過大な凸反りは本製品の絶縁破壊を起こし、重大事故に発展する場合があります。また、過大な凹反りやゆがみ等は、本製品と冷却フィン間に空隙が生じて放熱が悪くなり、熱破壊に繋がることがあります。
- (20) Please see the 『IGBT-IPM APPLICATION MANUAL』 and 『IGBT MODULES APPLICATION MANUAL』.
 『IGBT-IPM アプリケーションマニュアル』及び『IGBTモジュール アプリケーションマニュアル』を御参照ください。

12. Example of applied circuit

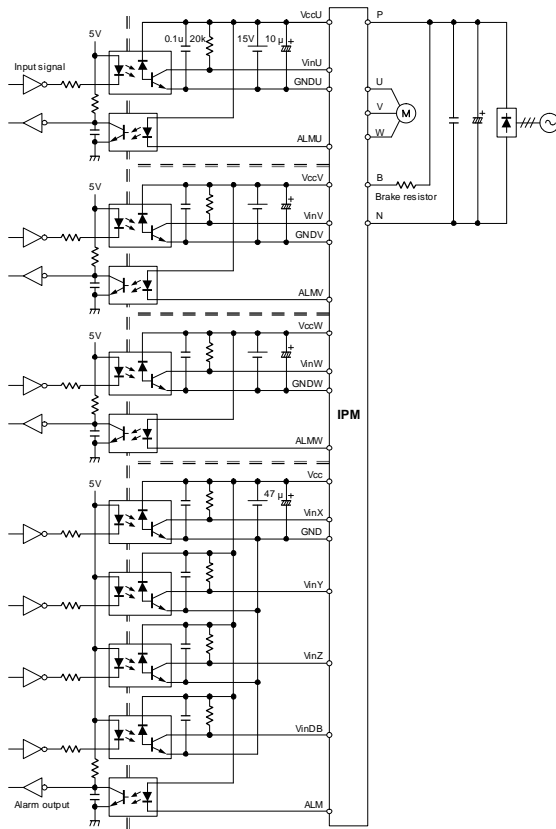

(a) In case of use of high-side alarm

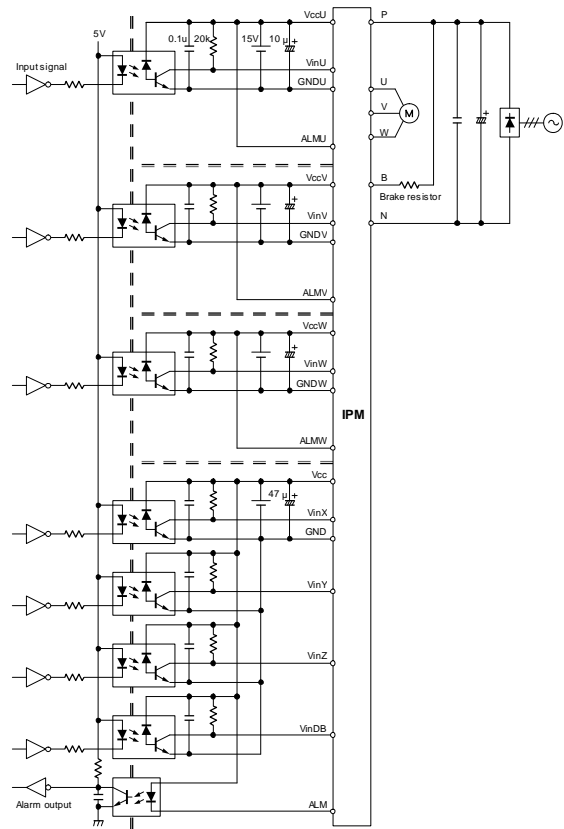

(b) In case of no use of high-side alarm

13. Packing and Label

Please see the packing specification of IPM (Technical Rep. No. : MT6M8302).

IPM 梱包仕様書MT6M8302を御参照ください。

14. Cautions for storage and transportation

- Store the IPM at a standard temperature and humidity. (5 to 35 , 45 to 75%)
Be careful to solderability of the terminals if the IPM has passed over one year from manufacturing date, under the above storage condition.
常温・常湿保存が望ましい。(5 ~ 35 , 45 ~ 75%)
本保存条件下で、製造から1年以上経過した場合は、端子はんだ付け性に十分注意する事。
- Avoid a sudden change in ambient temperature to prevent condensation on the module surfaces.
モジュールの表面が結露しないよう、急激な温度変化を避けて下さい。
- Avoid places where corrosive gas generates or much dust exists.
腐食性ガスの発生場所、粉塵の多い場所は避けて下さい。
- Store the module terminals under unprocessed conditions
モジュールの端子は未加工の状態での保管すること。
- Avoid physical shock or falls during the transportation.
運搬時に衝撃を与えたり落下させないで下さい。

15. Scope of application

This specification is applied to the IGBT-IPM (type: 7MBP50VDA060-50)

本仕様書は、IGBT-IPM (型式: 7MBP50VDA060-50)に適用する。

16. Based safety standards

UL1557

17. List of materials

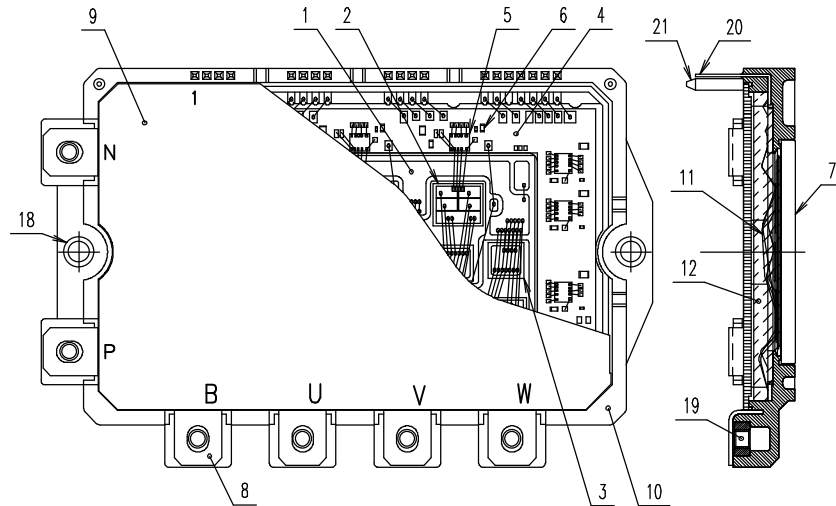

This figure doesn't show the chip size and chip layout exactly. For only explanation of materials.
 本図は、材料説明のための図であり、正確なチップサイズやレイアウトを表記したものではありません。

(Total weight of soldering material (typ.) : 4.9g)

No.	Parts	Material (main)	Ref.
1	Isolation substrate	Al ₂ O ₃ + Cu	
2	IGBT chip	Silicon	
3	FWD chip	Silicon	
4	Printed Circuit Board (PCB)	Glass reinforced Epoxy resin	Halogen Free
5	IC chip	Silicon	
6	Capacitor chip	Ceramics	Ni-Sn plating (External electrode) PbO (Internal electrode)
7	Base plate	Cu	Ni plating (External)
8	Main terminal	Cu	Ni plating (External)
9	Lid	PPS resin	UL 94V-0
10	Case	PPS resin	UL 94V-0
11	Wiring	Aluminum	
12	Silicone gel	Silicone gel	
13	Adhesive (Case, Lid)	Silicone resin	(Not drawn in above)
14	Adhesive (PCB)	Epoxy resin	(Not drawn in above)
15	Solder (Under chip)	Sn/Ag base(Pb Free)	(Not drawn in above)
16	Solder (Under Isolation substrate)	Sn/Ag base(Pb Free)	(Not drawn in above)
17	Solder (Under electronic parts)	Sn/Ag base(Pb Free)	(Not drawn in above)
18	Ring	SUS	
19	Nut	Fe	Trivalent chromate treatment
20	Control terminal	Brass	Au plating on Ni plating
21	Guide pin	Brass	
22	Label	PET	(Not drawn in above)

*1: PbO is excluded from RoHS directive.

18. RoHS Directive Compliance List of materials

The document (MS5F6209) about RoHS that Fuji Electric issued is applied to this Intelligent Power Module.
 The Japanese Edition (MS5F6212) is made into a reference grade.

本IPMは富士電機が発行しているRoHSに関する資料MS5F6209を適用する。
 日本語版 (MS5F6212) は参考資料とする。

Fuji Electric Co.,Ltd.

DWG.NO.

MS6M1427

16/26

a

19. Characteristics (Representative)

19-1. Control Circuit

Power supply current vs. Switching frequency
Tj= 25 (typ.)

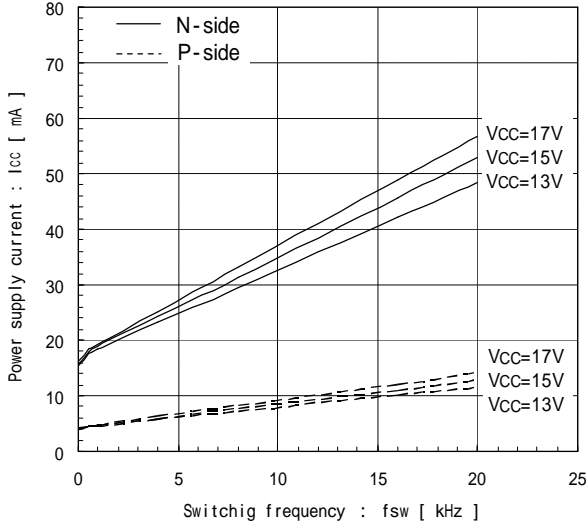

Input signal threshold voltage vs. Power supply voltage (typ.)

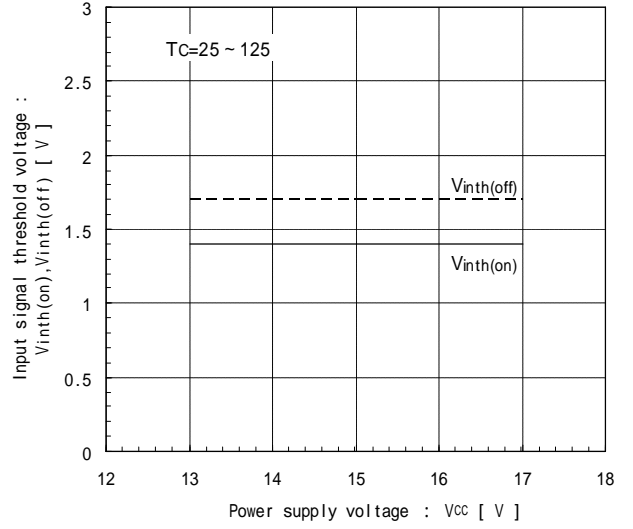

Under voltage vs. Junction temperature (typ.)

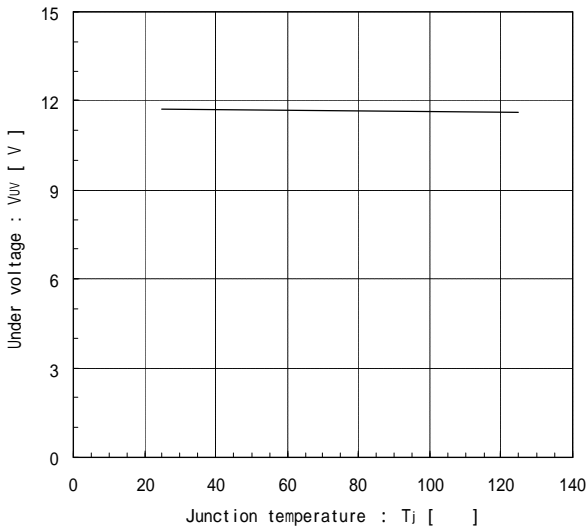

Under voltage hysteresis vs. Junction temperature (typ.)

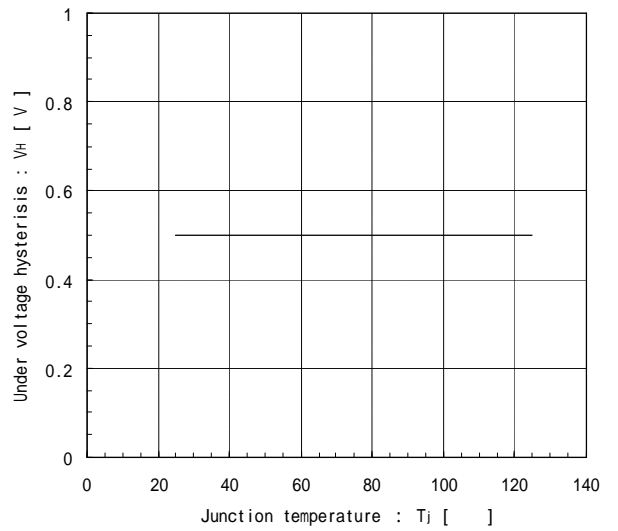

Alarm hold time vs. Power supply voltage (typ.)

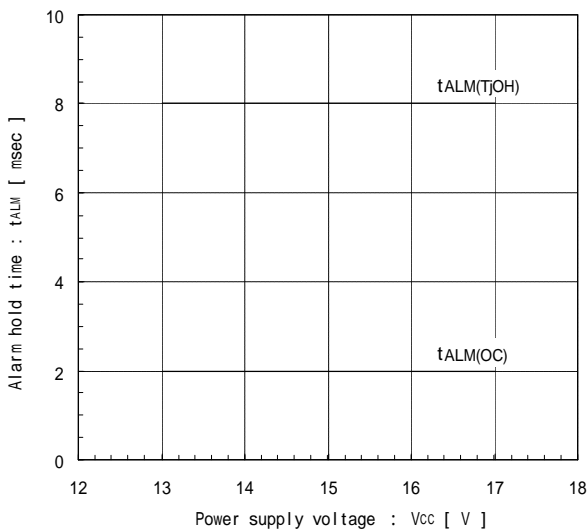

Over heating characteristics
TjOH, TjH vs. Vcc (typ.)

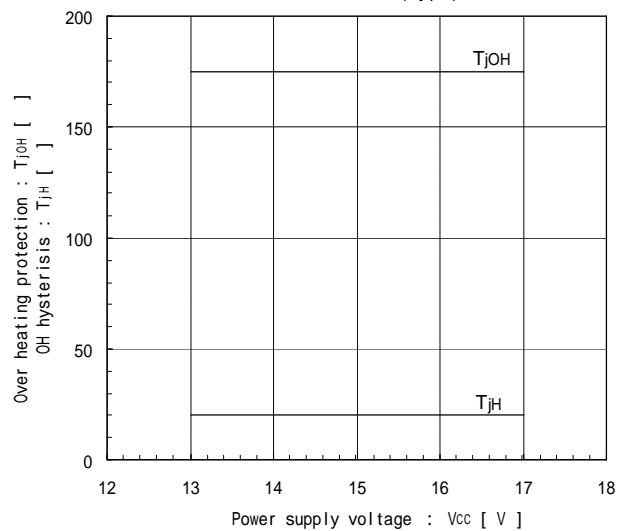

This material and the information herein is the property of Fuji Electric Co., Ltd. They shall be neither reproduced, copied, lent, or disclosed in any way whatsoever for the use of any third party nor used for the manufacturing purposes without the express written consent of Fuji Electric Co., Ltd.

19-2. Inverter

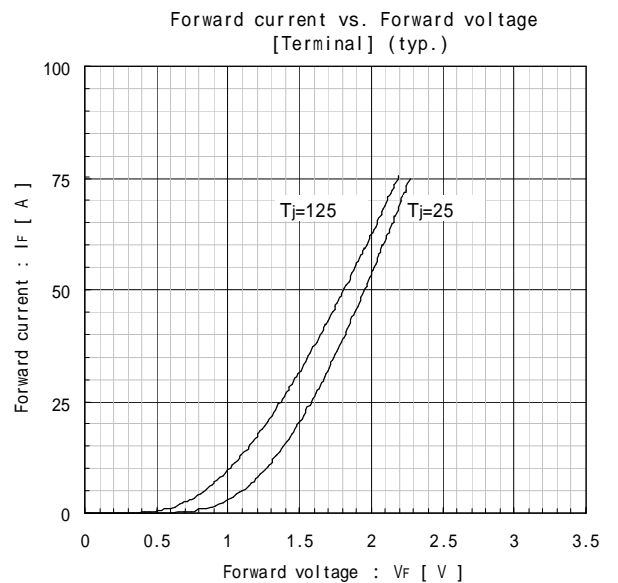
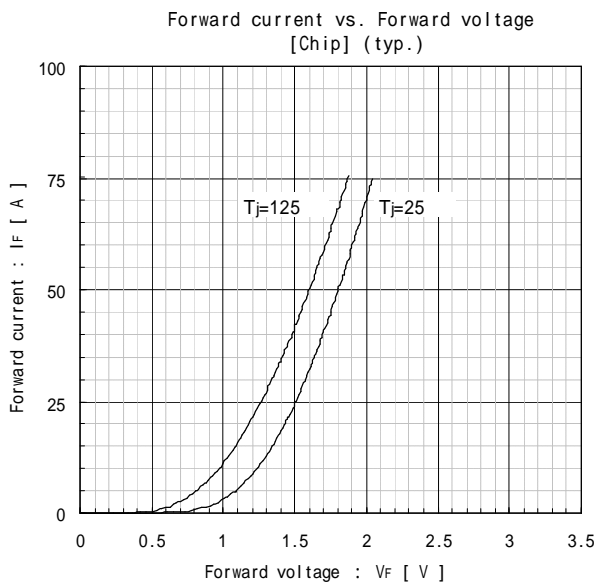
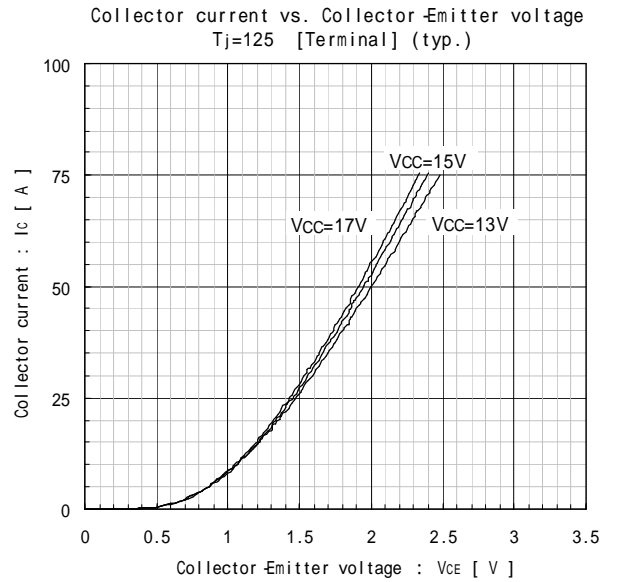
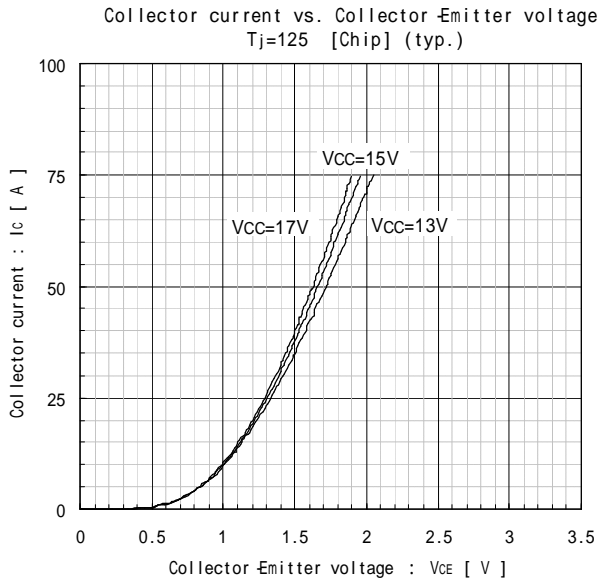
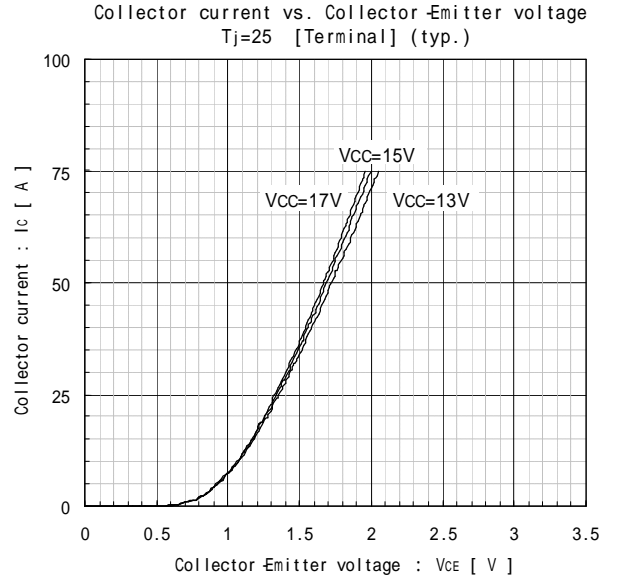
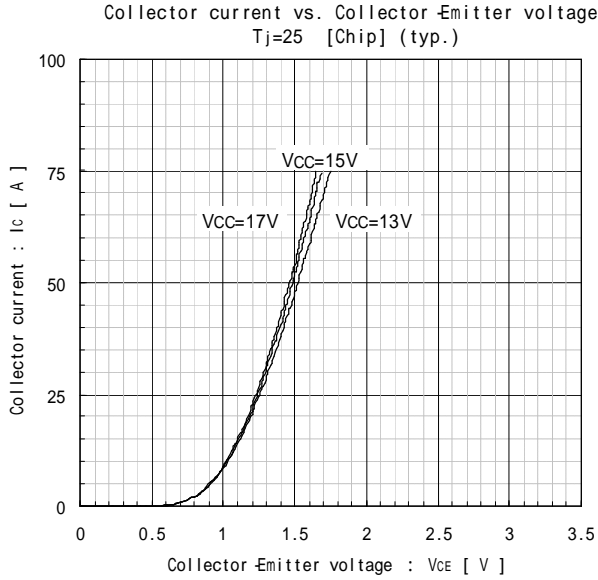

This material and the information herein is the property of Fuji Electric Co., Ltd.
 They shall be neither reproduced, copied, lent, or disclosed in any way whatsoever for
 the use of any third party nor used for the manufacturing purposes without the express
 written consent of Fuji Electric Co., Ltd.

This material and the information herein is the property of Fuji Electric Co., Ltd.
 They shall be neither reproduced, copied, lent, or disclosed in any way whatsoever for
 the use of any third party nor used for the manufacturing purposes without the express
 written consent of Fuji Electric Co., Ltd.

Switching Loss vs. Collector Current (typ.)
 $V_{DC}=300V, V_{CC}=15V, T_j=25$

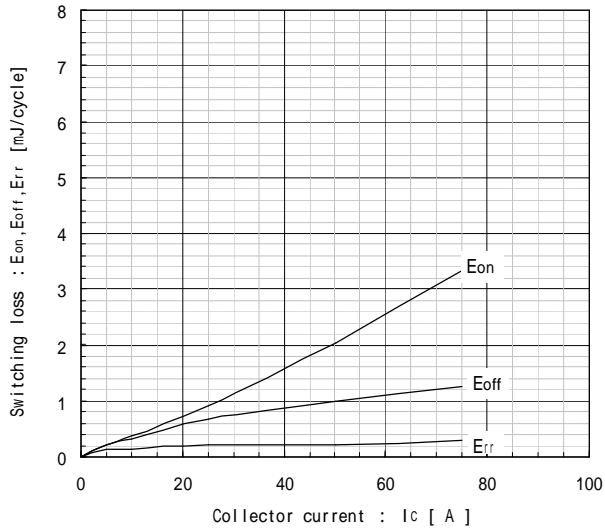

Switching Loss vs. Collector Current (typ.)
 $V_{DC}=300V, V_{CC}=15V, T_j=125$

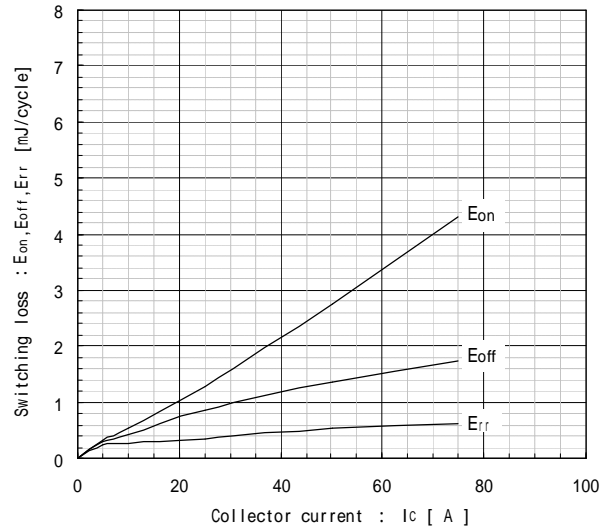

Reversed biased safe operating area
 $V_{CC}=15V, T_j=125$ [Main Terminal] (min.)

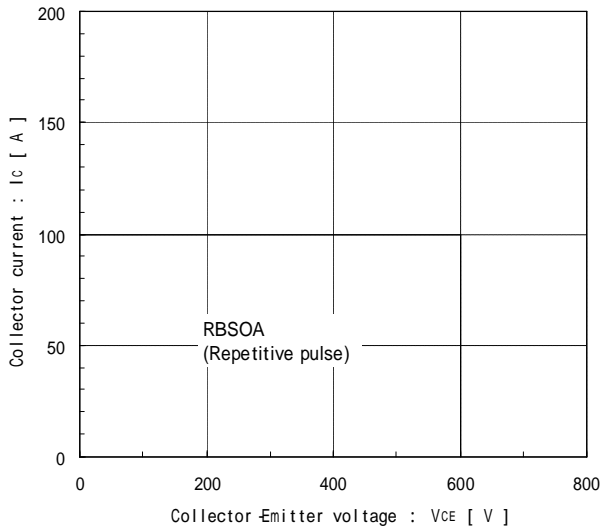

Transient thermal resistance (max.)

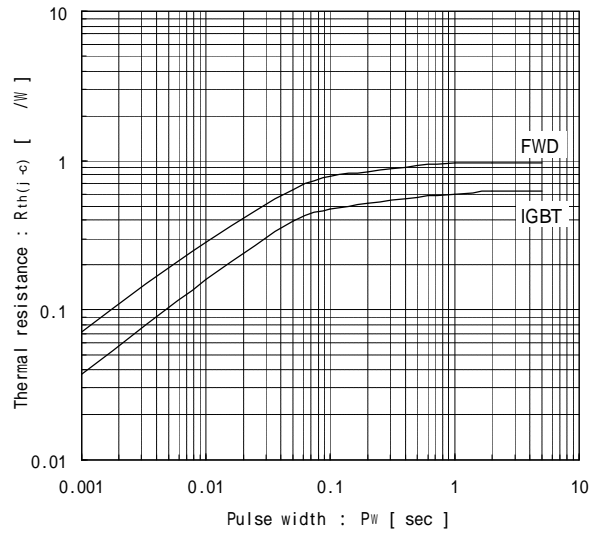

Power derating for IGBT (max.)
 [per device]

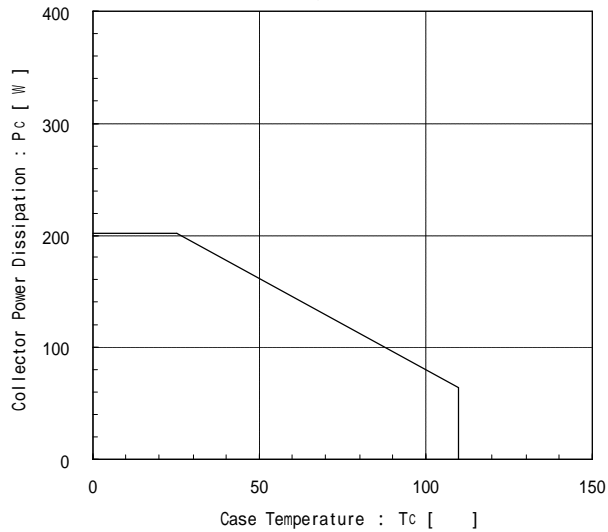

Power derating for FWD (max.)
 [per device]

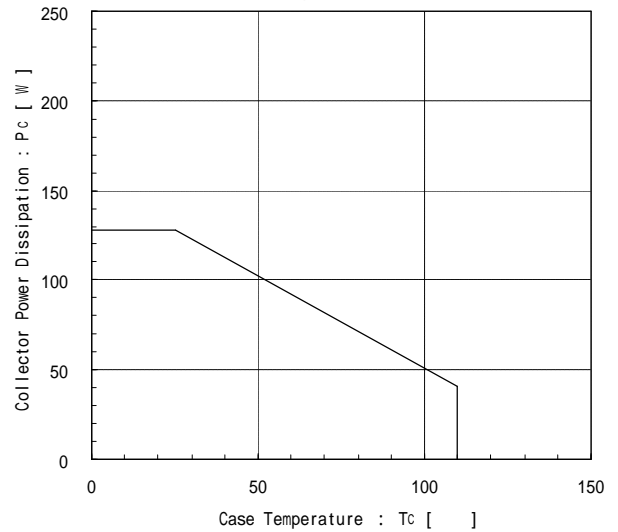

This material and the information herein is the property of Fuji Electric Co., Ltd.
 They shall be neither reproduced, copied, lent, or disclosed in any way whatsoever for
 the use of any third party nor used for the manufacturing purposes without the express
 written consent of Fuji Electric Co., Ltd.

Switching time vs. Collector current (typ.)
 $V_{DC}=300V, V_{CC}=15V, T_j=25$

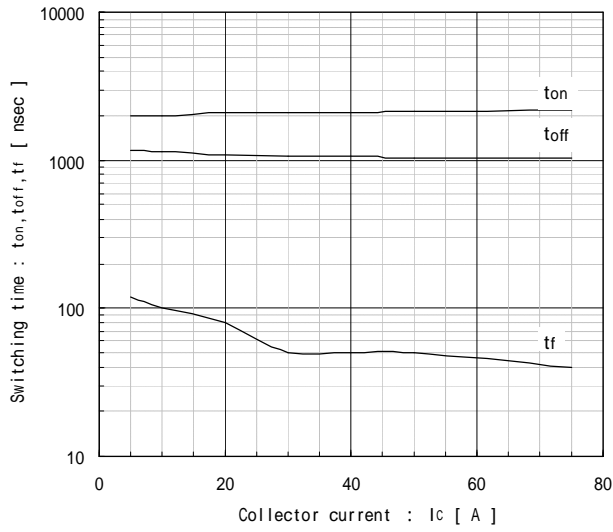

Switching time vs. Collector current (typ.)
 $V_{DC}=300V, V_{CC}=15V, T_j=125$

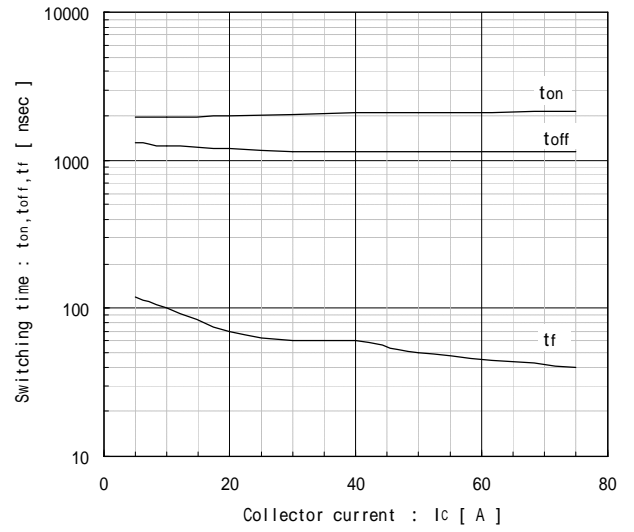

Reverse recovery characteristics (typ.)
 t_{rr}, I_{rr} vs. I_F

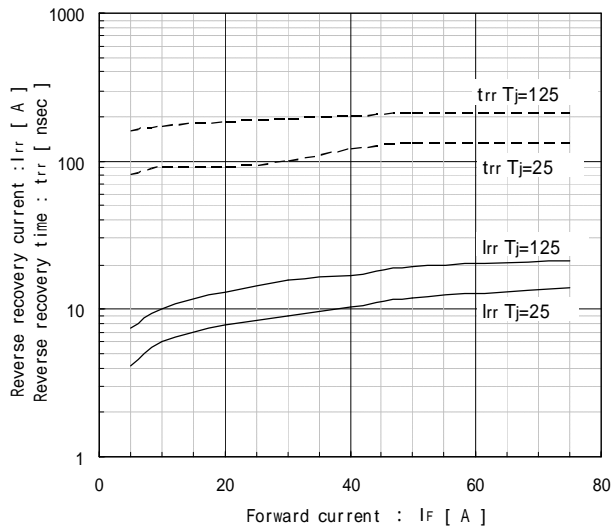

Over current protection vs. Junction temperature (typ.) $V_{CC}=15V$

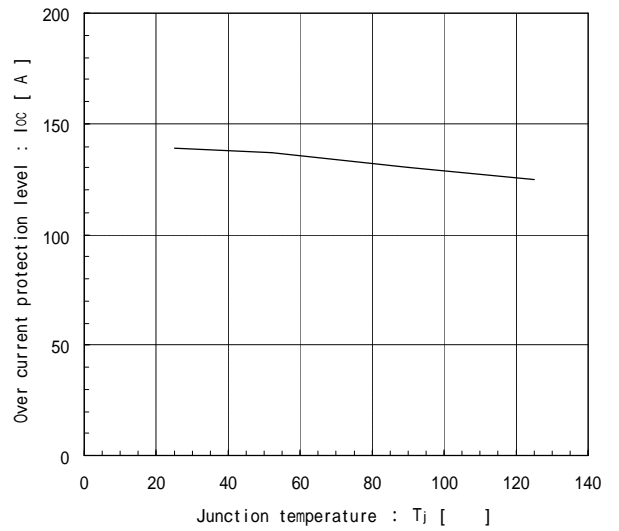

19-3. Brake

Collector current vs. Collector-Emmitter voltage
T_j=25 [Chip] (typ.)

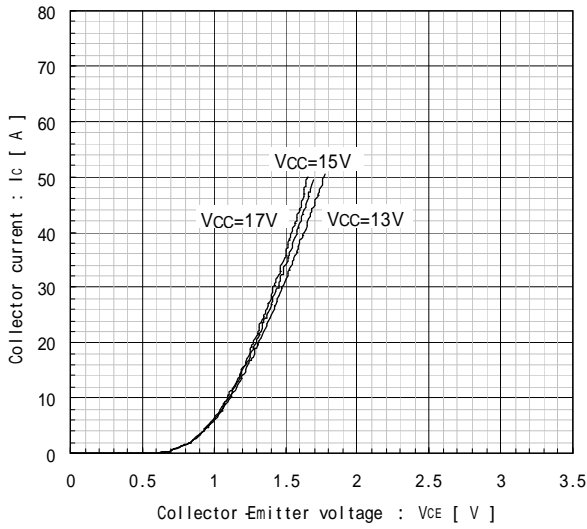

Collector current vs. Collector-Emmitter voltage
T_j=25 [Terminal] (typ.)

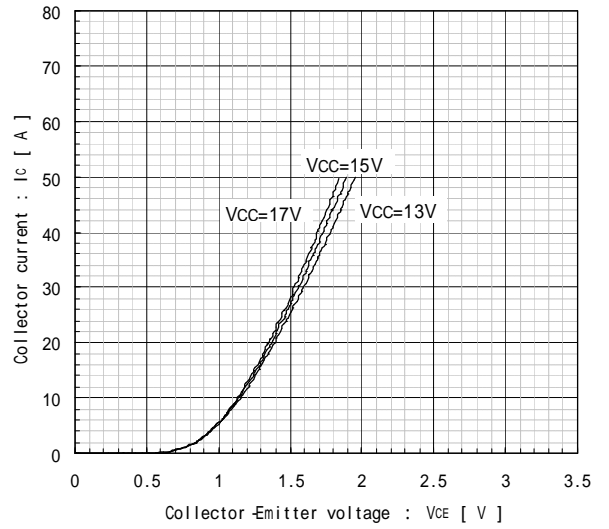

Collector current vs. Collector-Emmitter voltage
T_j=125 [Chip] (typ.)

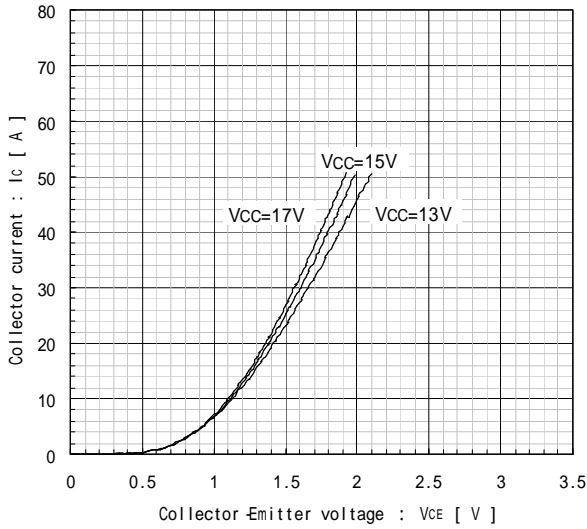

Collector current vs. Collector-Emmitter voltage
T_j=125 [Terminal] (typ.)

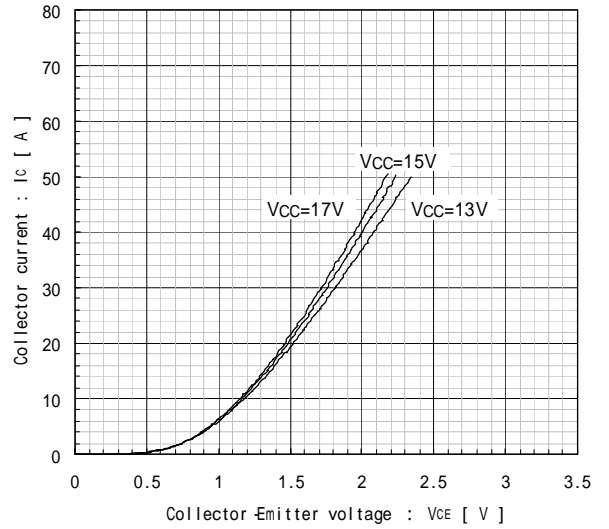

Forward current vs. Forward voltage
[Chip] (typ.)

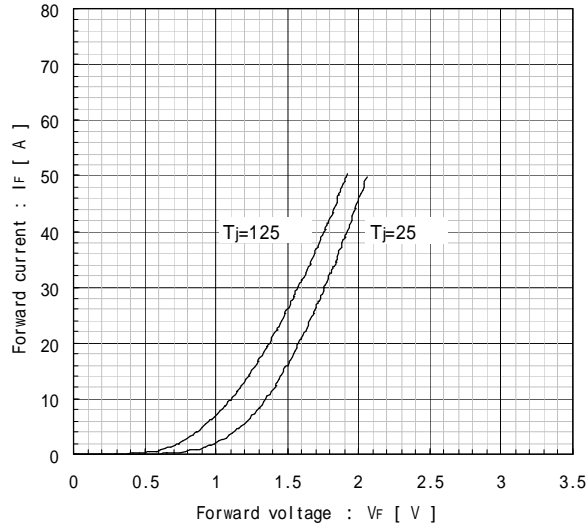

Forward current vs. Forward voltage
[Terminal] (typ.)

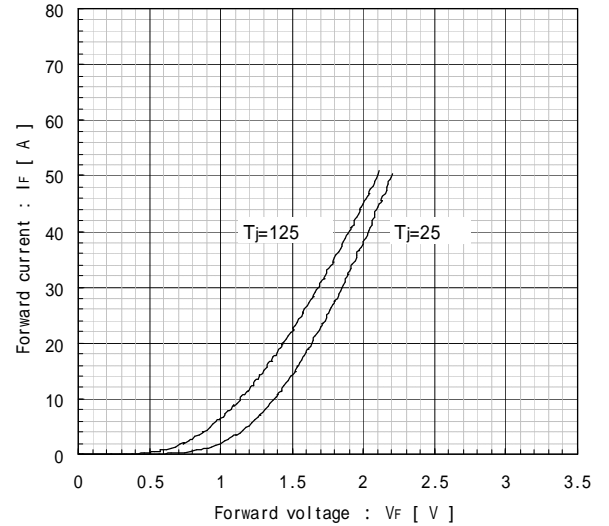

This material and the information herein is the property of Fuji Electric Co., Ltd. They shall be neither reproduced, copied, lent, or disclosed in any way whatsoever for the use of any third party nor used for the manufacturing purposes without the express written consent of Fuji Electric Co., Ltd.

This material and the information herein is the property of Fuji Electric Co., Ltd.
 They shall be neither reproduced, copied, lent, or disclosed in any way whatsoever for
 the use of any third party nor used for the manufacturing purposes without the express
 written consent of Fuji Electric Co., Ltd.

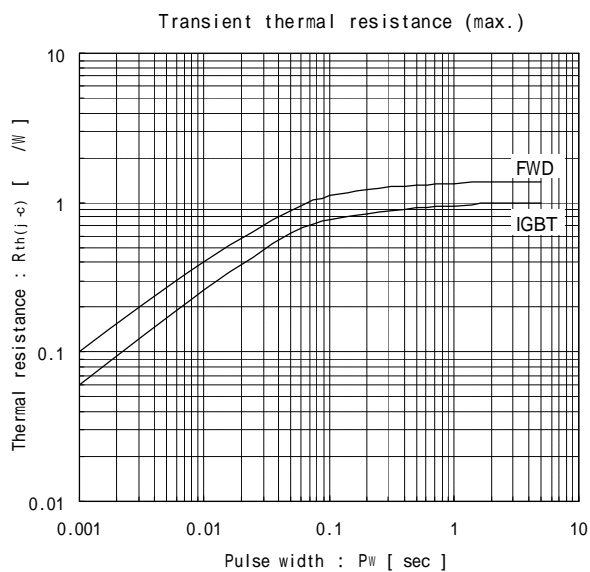
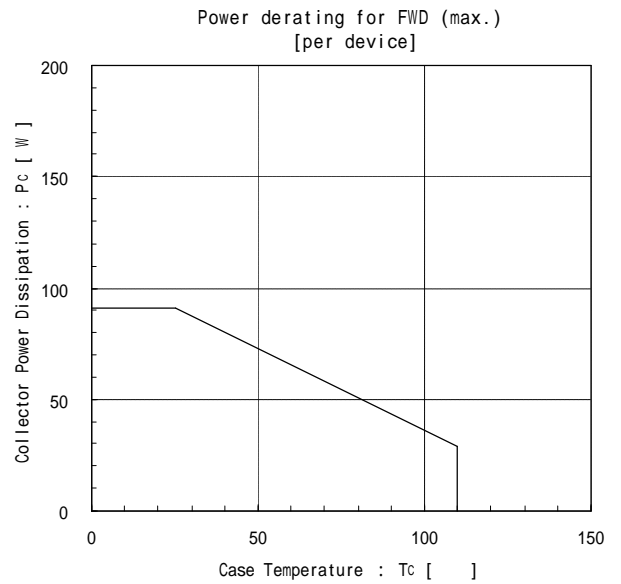
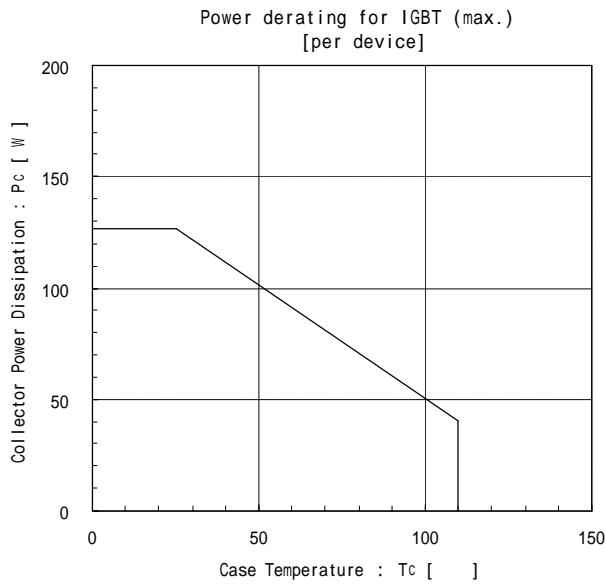
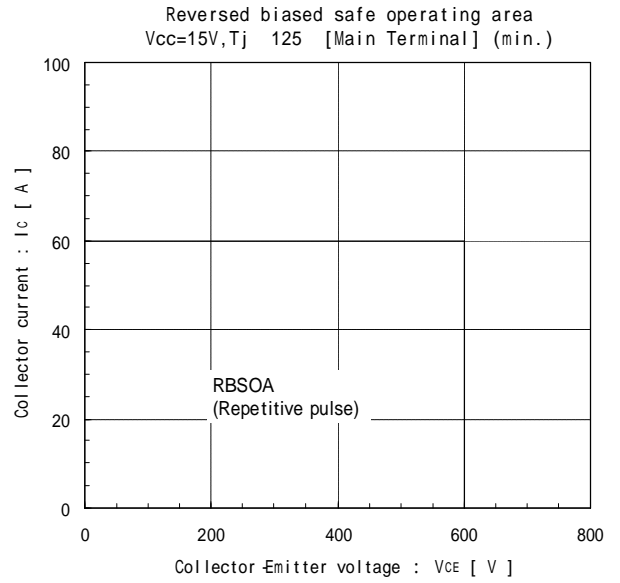
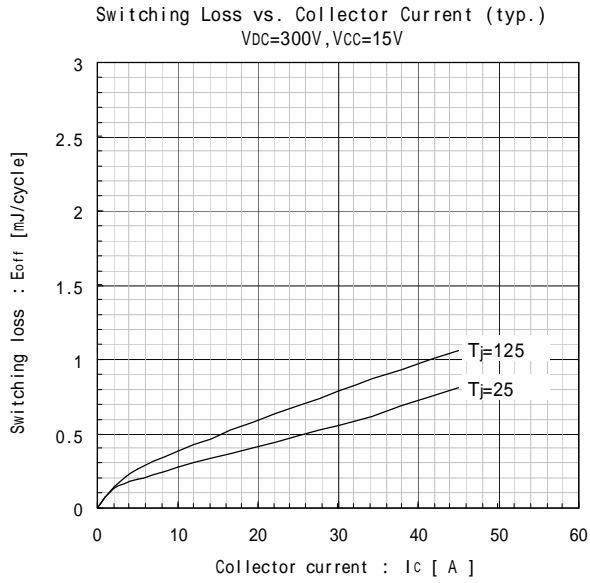

20. Reliability Test

Test conditions and results

Test categories	No.	Test items	Test methods and conditions	Reference norms EIAJ ED-4701	Number of sample	Acceptance number	Number of failure
Mechanical Tests 機械的試験	1	Terminal strength 端子強度 (Pull test)	Pull force : 40 N (main terminal) 10 N (control terminal) Test time : 10 ±1 sec.	Test Method 401 Method	5	(1 : 0)	0
	2	Mounting Strength 締付け強度	Screw torque : 1.3 ~ 1.7 N·m (M4) Test time : 10 ±1 sec.	Test Method 402 method	5	(1 : 0)	0
	3	Vibration 振動	Range of frequency : 10 ~ 500 Hz Sweeping time : 15 min. Acceleration : 100 m/s ² Sweeping direction : Each X,Y,Z axis Test time : 6 hr. (2hr./direction)	Test Method 403 Condition code B	5	(1 : 0)	0
	4	Shock 衝撃	Maximum acceleration : 5000 m/s ² Pulse width : 1.0 ms Direction : Each X,Y,Z axis Test time : 3 times/direction	Test Method 404 Condition code B	5	(1 : 0)	0
	5	Solderability はんだ付け性	Solder temp. : 245 ±5 Immersion duration : 5.0 ±0.5 sec. Test time : 1 time Solder Alloy : Sn-Ag-Cu Each terminal should be Immersed in solder within 1~1.5mm from the body.	Test Method 303	5	(1 : 0)	0
	6	Resistance to soldering heat はんだ耐熱性	Solder temp. : 260 ±5 Immersion time : 10 ±1sec. Test time : 1 time Each terminal should be Immersed in solder within 1~1.5mm from the body.	Test Method 302 Condition code A	5	(1 : 0)	0
Environment Tests 環境試験	1	High temperature storage 高温保存	Storage temp. : 125 ±5 Test duration : 1000 hr.	Test Method 201	5	(1 : 0)	0
	2	Low temperature storage 低温保存	Storage temp. : -40 ±5 Test duration : 1000 hr.	Test Method 202	5	(1 : 0)	0
	3	Temperature humidity storage 高温高湿保存	Storage temp. : 85 ±2 Relative humidity : 85 ±5% Test duration : 1000hr.	Test Method 103 Test code C	5	(1 : 0)	0
	4	Unsaturated Pressurized Vapor 不飽和蒸気加圧	Test temp. : 120 ±2 Test humidity : 85 ±5% Test duration : 96 hr.	Test Method 103 Test code E	5	(1 : 0)	0
	5	Temperature cycle 温度サイクル	Test temp. : Minimum storage temp. -40 ±5 Maximum storage temp. 125 ±5 Normal temp. 5 ~ 35 Dwell time : Tmin ~ TN ~ Tmax ~ TN 1hr. 0.5hr. 1hr. 0.5hr. Number of cycles : 100 cycles	Test Method 105	5	(1 : 0)	0
	6	Thermal shock 熱衝撃	Test temp. : High temp. side 100 ⁺⁰ ₋₅ Low temp. side 0 ⁺⁵ ₋₀ Fluid used : Pure water (running water) Dipping time : 5 min. par each temp. Transfer time : 10 sec. Number of cycles : 10 cycles	Test Method 307 method Condition code A	5	(1 : 0)	0

This material and the information herein is the property of Fuji Electric Co., Ltd. They shall be neither reproduced, copied, lent, or disclosed in any way whatsoever for the use of any third party nor used for the manufacturing purposes without the express written consent of Fuji Electric Co., Ltd.

Test conditions and results

Test categories	No.	Test items	Test methods and conditions	Reference norms EIAJ ED-4701	Number of sample	Acceptance number	Number of failure
Endurance Tests 耐久性試験	1	High temperature reverse bias 高温逆バイアス	Test temp. : Ta = 125 ±5 (Tj 150) Bias Voltage : VC = 0.8xVCES Bias Method : Applied DC voltage to C-E Vcc = 15V Test duration : 1000 hr.	Test Method 101	5	(1 : 0)	0
	2	Temperature humidity bias 高温高湿バイアス	Test temp. : 85 ±2 Relative humidity : 85 ±5 % Bias Voltage : VC = 0.8xVCES Vcc = 15V Bias Method : Applied DC voltage to C-E Test duration : 1000 hr.	Test Method 102 Condition code C	5	(1 : 0)	0
	3	Intermitted operating life (Delta-Tj Power cycle) 断続動作	ON time : 2 sec. OFF time : 18 sec. Test temp. : D Tj=100 ±5deg Tj 150 , Ta=25 ±5 Number of cycles : 15000 cycles	Test Method 106	5	(1 : 0)	0

Failure Criteria

Item	Characteristic	Symbol	Failure criteria		Unit	
			Lower limit	Upper limit		
Electrical characteristic	Leakage current	ICES	-	USLx2.0	mA	
	Saturation voltage	VCE(sat)	-	USLx1.2	V	
	Forward voltage	VF	-	USLx1.2	V	
	Thermal resistance	IGBT	Rth(j-c)Q	-	USLx1.2	/W
		FWD	Rth(j-c)D	-	USLx1.2	/W
	Over Current Protection	IOC	LSLx0.8	USLx1.2	A	
	Alarm signal hold time	tALM	LSLx0.8	USLx1.2	ms	
Visual inspection	Isolation voltage	Viso	Broken insulation		-	
	Visual inspection Peeling Plating and the others	-	The visual sample		-	

LSL : Lower specified limit.

USL : Upper specified limit.

Note :

Each parameter measurement read-outs shall be made after stabilizing the components at room ambient for 2 hours minimum, 24 hours maximum after removal from the tests. And in case of the wetting tests, for example, moisture resistance tests, each component shall be made wipe or dry completely before the measurement.

信頼性試験後の電気的特性検査及び外観検査は、試験終了後2時間以上、24時間以内室温に放置後行う。又、耐湿性試験や熱衝撃試験のように水分の付着または、内部浸入の可能性のある項目については表面を拭き、エアブローで表面の水分を除去し、十分に水分が除去された状態で測定する。

This material and the information herein is the property of Fuji Electric Co., Ltd. They shall be neither reproduced, copied, lent, or disclosed in any way whatsoever for the use of any third party nor used for the manufacturing purposes without the express written consent of Fuji Electric Co., Ltd.

Warnings

- This product shall be used within its absolute maximum rating (voltage, current, and temperature). This product may be broken in case of using beyond the ratings.
製品の絶対最大定格(電圧, 電流, 温度等)の範囲内で御使用下さい。
絶対最大定格を超えて使用すると、素子が破壊する場合があります。
- Connect adequate fuse or protector of circuit between three-phase line and this product to prevent the equipment from causing secondary destruction.
万一の不慮の事故で素子が破壊した場合を考慮し、商用電源と本製品の間に適切な容量のヒューズ又はブレーカーを必ず付けて2次破壊を防いでください。
- When studying the device at a normal turn-off action, make sure that working paths of the turn-off voltage and current are within the RBSOA specification.
通常のターンオフ動作における素子責務の検討の際には、ターンオフ電圧・電流の動作軌跡がRBSOA仕様内にあることを確認して下さい。
- Use this product after realizing enough working on environment and considering of product's reliability life. This product may be broken before target life of the system in case of using beyond the product's reliability life.
製品の使用環境を十分に把握し、製品の信頼性寿命が満足できるか検討の上、本製品を適用して下さい。
製品の信頼性寿命を超えて使用した場合、装置の目標寿命より前に素子が破壊する場合があります。
- If the product had been used in the environment with acid, organic matter, and corrosive gas (For example : hydrogen sulfide, sulfurous acid gas), the product's performance and appearance can not be ensured easily.
酸・有機物・腐食性ガス(硫化水素, 亜硫酸ガス等)を含む環境下で使用された場合、製品機能・外観などの保証は致しかねます。
- Use this product within the delta-Tj power cycle curve (Technical Rep.No. : MT5Z02525) and the delta-Tc power cycle curve (Technical Rep.No. : MT5Z02509)
Power cycle capability is classified to delta-Tj mode which is stated as above and delta-Tc mode. Delta-Tc mode is due to rise and down of case temperature (Tc), and depends on cooling design of equipment which use this product. In application which has such frequent rise and down of Tc, well consideration of product life time is necessary.
本製品は、Tjパワーサイクル寿命カーブ(技術資料No.: MT5Z02525)と Tcパワーサイクル寿命カーブ(技術資料No.: MT5Z02509)の範囲内で使って下さい。
パワーサイクル耐量にはこの Tjによる場合の他に、Tcによる場合があります。これはケース温度(Tc)の上昇下降による熱ストレスであり、本製品をご使用する際の放熱設計に依存します。ケース温度の上昇下降が頻繁に起こる場合は、製品寿命に十分留意してご使用下さい。
- Never add mechanical stress to deform the main or control terminal.
The deformed terminal may cause poor contact problem.
主端子及び制御端子に応力を与えて変形させないで下さい。
端子の変形により、接触不良などを引き起こす場合があります。

This material and the information herein is the property of Fuji Electric Co., Ltd. They shall be neither reproduced, copied, lent, or disclosed in any way whatsoever for the use of any third party nor used for the manufacturing purposes without the express written consent of Fuji Electric Co., Ltd.

Warnings

- According to the outline drawing, select proper length of screw for main terminal.
Longer screws may break the case.
本製品に使用する主端子用のネジの長さは、外形図に従い正しく選定下さい。
ネジが長いとケースが破損する場合があります。
- If excessive static electricity is applied to the control terminals, the devices can be broken.
Implement some countermeasures against static electricity.
制御端子に過大な静電気が印加された場合、素子が破壊する場合があります。
取り扱い時は静電気対策を実施して下さい。
- Use the latest version Specification and Application Manual every time in case of designing the new equipment.
新規装置設計の際は、常に最新の仕様書及びアプリケーションマニュアルを適用してください。

Cautions

- Fuji Electric is constantly making every endeavor to improve the product quality and reliability. However, semiconductor products may rarely happen to fail or malfunction. To prevent accidents causing injury or death, damage to property like by fire, and other social damage resulted from a failure or malfunction of the Fuji Electric semiconductor products, take some measures to keep safety such as redundant design, spread-fire-preventive design, and malfunction-protective design.
富士電機は絶えず製品の品質と信頼性の向上に努めています。しかし、半導体製品は故障が発生したり、誤動作する場合があります。富士電機製半導体製品の故障または誤動作が、結果として人身事故・火災等による財産に対する損害や社会的な損害を起こさないように冗長設計・延焼防止設計・誤動作防止設計など安全確保のための手段を講じて下さい。
- The application examples described in this specification only explain typical ones that used the Fuji Electric products. This specification never ensure to enforce the industrial property and other rights, nor license the enforcement rights.
本仕様書に記載してある応用例は、富士電機製品を使用した代表的な応用例を説明するものであり、本仕様書によって工業所有権、その他権利の実施に対する保障または実施権の許諾を行うものではありません。
- The product described in this specification is not designed nor made for being applied to the equipment or systems used under life-threatening situations. When you consider applying the product of this specification to particular used, such as vehicle-mounted units, shipboard equipment, aerospace equipment, medical devices, atomic control systems and submarine relaying equipment or systems, please apply after confirmation of this product to be satisfied about system construction and required reliability.
本仕様書に記載された製品は、人命にかかわるような状況下で使用される機器あるいはシステムに用いられることを目的として設計・製造されたものではありません。本仕様書の製品を車両機器、船舶、航空宇宙、医療機器、原子力制御、海底中継機器あるいはシステムなど、特殊用途へのご利用をご検討の際は、システム構成及び要求品質に満足することをご確認の上、ご利用下さい。

If there is any unclear matter in this specification, please contact Fuji Electric Co., Ltd.