

## IGBT Module

### Features

- Low VCE (sat) trench IGBT
- Low switching losses
- 10us short circuit capability
- Fast & soft reverse recovery FRD
- Maximum junction temperature 175°C
- Temperature sense included
- Industry standard package with insulated copper base plate and soldering pins for PCB mounting



### Typical Applications

- Inverter for motor drive
- AC and DC servo drive amplifier
- Uninterruptible power supply

### IGBT-inverter $T_c=25^\circ\text{C}$ unless otherwise noted

#### Maximum Rated Values

Symbol	Description	HYG30P120H1K1	Units
$V_{CES}$	Collector-Emitter Voltage $T_j=25^\circ\text{C}$	1200	V
$V_{GES}$	Gate-Emitter Voltage $T_j=25^\circ\text{C}$	20	V
$I_c$	Collector Current	40	A
	Collector Current $T_C=80^\circ\text{C}$	30	
$I_{CM}$	Pulsed Collector Current $t_p=1\text{ms}$	50	A
$P_{tot}$	Total Power Dissipation $T_j=175^\circ\text{C}$	200	W

## Characteristics Values

Symbol	Parameter		Min.	Typ.	Max.	Units
$V_{(BR)CES}$	Collector-Emitter Breakdown Voltage	$T_J=25^{\circ}\text{C}$	1200			V
$I_{CES}$	Collector Cut- Off Current	$V_{CE}=V_{CES}, V_{GE}=0\text{V}, T_J=25^{\circ}\text{C}$			0.1	mA
$I_{GES}$	Gate-Emitter Leakage Current	$V_{GE}=V_{GES}, V_{CE}=0\text{V}, T_J=25^{\circ}\text{C}$			400	nA
$V_{GE(th)}$	Gate to Emitter Threshold Voltage	$I_C=1.2\text{mA}, V_{GE}=V_{CE}, T_J=25^{\circ}\text{C}$	4.6	5.2	6.0	V
$V_{CE(sat)}$	Collector to Emitter Saturation Voltage	$I_C=25\text{A}, V_{GE}=15\text{V}, T_J=25^{\circ}\text{C}$		2.1	2.5	V
		$I_C=25\text{A}, V_{GE}=15\text{V}, T_J=125^{\circ}\text{C}$		2.4		
$R_{Gint}$	Integrated Gate Resistor			--		$\Omega$
$Q_g$	Gate Charge	$V_{CE}=600\text{V}, I_C=25\text{A}, V_{GE}=15\text{V}$		0.17		$\mu\text{C}$
$C_{ies}$	Input Capacitance	$V_{CE}=25\text{V}, V_{GE}=0\text{V}, f=1\text{MHz}$		2.6		nF
$C_{res}$	Reverse Transfer Capacitance			0.06		nF
$t_{d(on)}$	Turn - on Delay Time	$V_{CC}=600\text{V}, I_C=25\text{A}, R_G=20\Omega,$	$T_{vj}=25^{\circ}\text{C}$		35	ns
			$T_{vj}=125^{\circ}\text{C}$		40	ns
$t_r$	Rise Time	$V_{GE}=\pm 15\text{V},$ Inductive Load	$T_{vj}=25^{\circ}\text{C}$		40	ns
			$T_{vj}=125^{\circ}\text{C}$		45	ns
$t_{d(off)}$	Turn - off Delay Time	$V_{CC}=600\text{V}, I_C=25\text{A}, R_G=20\Omega,$	$T_{vj}=25^{\circ}\text{C}$		240	ns
			$T_{vj}=125^{\circ}\text{C}$		270	ns
$t_f$	Fall Time	$V_{GE}=\pm 15\text{V},$ Inductive Load	$T_{vj}=25^{\circ}\text{C}$		100	ns
			$T_{vj}=125^{\circ}\text{C}$		130	ns
$E_{on}$	Turn - on Energy	$V_{CC}=600\text{V}, I_C=25\text{A}, R_G=20\Omega,$	$T_{vj}=25^{\circ}\text{C}$		1.9	mJ
			$T_{vj}=125^{\circ}\text{C}$		2.7	mJ
$E_{off}$	Turn - off Energy	$V_{GE}=\pm 15\text{V},$ Inductive Load	$T_{vj}=25^{\circ}\text{C}$		1.7	mJ
			$T_{vj}=125^{\circ}\text{C}$		2.1	mJ
$I_{sc}$	Short Circuit Current	$t_{ps} \leq 10\mu\text{s}, V_{GE}=15\text{V}$ $T_{vj}=125^{\circ}\text{C}, V_{CC}=600\text{V}$		125		A
$R_{thJC}$	Junction-to-Case Thermal Resistance ( Per IGBT )				0.62	K/W

## DIODE-inverter $T_c=25^{\circ}\text{C}$ unless otherwise noted

### Maximum Rated Values

Symbol	Description	HYG30P120H1K1	Units
$V_{RRM}$	Repetitive Peak Reverse Voltage $T_J=25^{\circ}\text{C}$	1200	V
$I_F$	DC Forward Current $T_c=80^{\circ}\text{C}$	30	A
$I_{FRM}$	Repetitive Peak Forward Current	60	A

## Characteristics Values

Symbol	Parameter		Min.	Typ.	Max.	Units
$V_F$	Forward Voltage	IF=25A , VGE=0V, T <sub>Vj</sub> =25°C IF=25A , VGE=0V, T <sub>Vj</sub> =125°C		1.85 1.95	2.15	V
$t_{rr}$	Reverse Recovery Time	IF=25A , VR=600V diF/dt=-600A/μs T <sub>Vj</sub> =125°C		120		ns
$I_{RRM}$	Max. Reverse Recovery Current			37		A
$E_{rec}$	Reverse Recovery Charge			1.6		mJ
$R_{thJC}$	Junction-to-Case Thermal Resistance ( Per DIODE )				1.2	K/W

## DIODE-rectifier T<sub>c</sub>=25°C unless otherwise noted

### Maximum Rated Values

Symbol	Description	HYG30P120H1K1	Units
$V_{RRM}$	Repetitive Peak Reverse Voltage T <sub>j</sub> =25°C	1600	V
$I_{F(AV)}$	Average On-state Current per Diode T <sub>c</sub> =80°C	25	A
$I_{RMSM}$	Maximum RMS Current at rectifier Output	tdb	A
$I^2t$	VR=0V, tp=10ms, T <sub>j</sub> =45°C	310	A <sup>2</sup> t
$I_{FSM}$	Surge Forward Current VR=0V, tp=10ms, T <sub>j</sub> =45°C	252	A

## Characteristics Values

Symbol	Parameter	Test Conditions	Min.	Typ.	Max.	Units
$V_F$	Diode Forward Voltage	IF=25A	T <sub>j</sub> =25°C		1.3	V
			T <sub>j</sub> =125°C		1.0	
$I_R$	Reverse Current	VR=1600V	T <sub>j</sub> =25°C		50	μA
			T <sub>j</sub> =125°C		1	mA
$R_{thJC}$	Junction-to-Case Thermal Resistance ( Per DIODE )				1.35	K/W

## IGBT-brake-chopper T<sub>c</sub>=25°C unless otherwise noted

### Maximum Rated Values

Symbol	Description	HYG30P120H1K1	Units
$V_{CES}$	Collector-Emitter Voltage T <sub>j</sub> =25°C	1200	V
$V_{GES}$	Gate-Emitter Voltage T <sub>j</sub> =25°C	20	V
$I_C$	Collector Current	50	A
	Collector Current T <sub>c</sub> =80°C	25	
$I_{CM}$	Pulsed Collector Current tp=1ms	50	A
$P_{tot}$	Total Power Dissipation T <sub>j</sub> =175°C	240	W

## Characteristics Values

Symbol	Parameter		Min.	Typ.	Max.	Units
$V_{(BR)CES}$	Collector-Emitter Breakdown Voltage	$T_j=25^\circ\text{C}$	1200			V
$I_{CES}$	Collector Cut- Off Current	$V_{CE}=V_{CES}, V_{GE}=0\text{V}, T_j=25^\circ\text{C}$			5	mA
$I_{GES}$	Gate-Emitter Leakage Current	$V_{GE}=V_{GES}, V_{CE}=0\text{V}, T_j=25^\circ\text{C}$			400	nA
$V_{GE(th)}$	Gate to Emitter Threshold Voltage	$I_C=1.2\text{mA}, V_{GE}=V_{CE}, T_j=25^\circ\text{C}$	5	5.8	7.5	V
$V_{CE(sat)}$	Collector to Emitter Saturation Voltage	$I_C=25\text{A}, V_{GE}=15\text{V}, T_j=25^\circ\text{C}$		1.9	2.3	V
		$I_C=25\text{A}, V_{GE}=15\text{V}, T_j=125^\circ\text{C}$		2.3		
$R_{Gint}$	Integrated Gate Resistor			--		$\Omega$
$Q_g$	Gate Charge	$V_{CE}=600\text{V}, I_C=25\text{A}, V_{GE}=15\text{V}$		0.17		$\mu\text{C}$
$C_{ies}$	Input Capacitance	$V_{CE}=30\text{V}, V_{GE}=0\text{V}, f=1\text{MHz}$		2.6		nF
$C_{res}$	Reverse Transfer Capacitance			0.08		nF
$t_{d(on)}$	Turn - on Delay Time	$V_{CC}=600\text{V}, I_C=25\text{A}, R_G=33\Omega,$	$T_{vj}=25^\circ\text{C}$		233	ns
			$T_{vj}=125^\circ\text{C}$		310	ns
$t_r$	Rise Time	$V_{GE}=\pm 15\text{V},$ Inductive Load	$T_{vj}=25^\circ\text{C}$		66	ns
			$T_{vj}=125^\circ\text{C}$		86	ns
$t_{d(off)}$	Turn - off Delay Time	$V_{CC}=600\text{V}, I_C=25\text{A}, R_G=33\Omega,$	$T_{vj}=25^\circ\text{C}$		184	ns
			$T_{vj}=125^\circ\text{C}$		217	ns
$t_f$	Fall Time	$V_{GE}=\pm 15\text{V},$ Inductive Load	$T_{vj}=25^\circ\text{C}$		208	ns
			$T_{vj}=125^\circ\text{C}$		324	ns
$E_{on}$	Turn - on Energy	$V_{CC}=600\text{V}, I_C=25\text{A}, R_G=33\Omega,$	$T_{vj}=25^\circ\text{C}$		3.06	mJ
			$T_{vj}=125^\circ\text{C}$		3.16	mJ
$E_{off}$	Turn - off Energy	$V_{GE}=\pm 15\text{V},$ Inductive Load	$T_{vj}=25^\circ\text{C}$		1.16	mJ
			$T_{vj}=125^\circ\text{C}$		1.78	mJ
$I_{sc}$	Short Circuit Current	$t_{ps}\leq 10\mu\text{S}, V_{GE}=15\text{V}$ $T_{vj}=125^\circ\text{C}, V_{CC}=900\text{V}$		240		A
$R_{thJC}$	Junction-to-Case Thermal Resistance ( Per IGBT )				0.62	K/W

## DIODE-brake-chopper $T_c=25^\circ\text{C}$ unless otherwise noted

### Maximum Rated Values

Symbol	Description	HYG30P120H1K1	Units
$V_{RRM}$	Repetitive Peak Reverse Voltage $T_j=25^\circ\text{C}$	1200	V
$I_F$	DC Forward Current $T_c=80^\circ\text{C}$	30	A
$I_{FRM}$	Repetitive Peak Forward Current	60	A

### Characteristics Values

Symbol	Parameter		Min.	Typ.	Max.	Units
$V_F$	Forward Voltage	IF=25A , VGE=0V, T <sub>Vj</sub> =25°C IF=25A , VGE=0V, T <sub>Vj</sub> =125°C		1.85 1.95	2.15	V
$t_{rr}$	Reverse Recovery Time	IF=25A , VR=600V		120		ns
$I_{RRM}$	Max. Reverse Recovery Current	diF/dt=-600A/μs		37		A
$E_{rec}$	Reverse Recovery Charge	T <sub>Vj</sub> =125°C		1.6		mJ
$R_{thJC}$	Junction-to-Case Thermal Resistance ( Per DIODE )				1.2	K/W

### Electrical Characteristics of NTC T<sub>c</sub>=25°C unless otherwise noted

Symbol	Parameter	Test Conditions	Min.	Typ.	Max.	Units
R25	Rated Resistance	T <sub>c</sub> =25°C		5.0		kΩ
ΔR/R	Deviation of R100	T <sub>c</sub> =100°C, R100=493Ω	-5		5	
P25	Power Dissipation	T <sub>c</sub> =25°C			20	mW
B25/50	B value			3375		K

### Module Characteristics

Symbol	Parameter	Min.	Typ.	Max.	Units
$V_{iso}$	Isolation Voltage RMS, f=50Hz, t=1min		2500		V
$T_{Vjmax}$	Maximum Junction Temperature			150	°C
$T_{Vjop}$	Storage Temperature	-40		123	°C
Md	Mounting Screw:M5	3		6	N·m
$T_{STG}$	Storage Temperature range	-40		125	°C
Weight				190	g

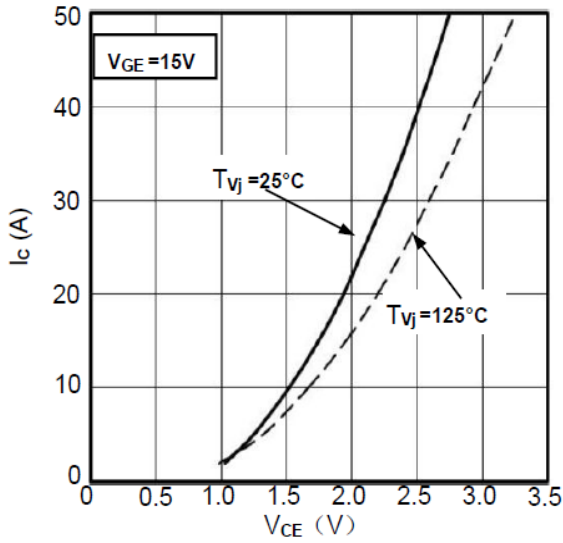

Figure1. Typical Output Characteristics

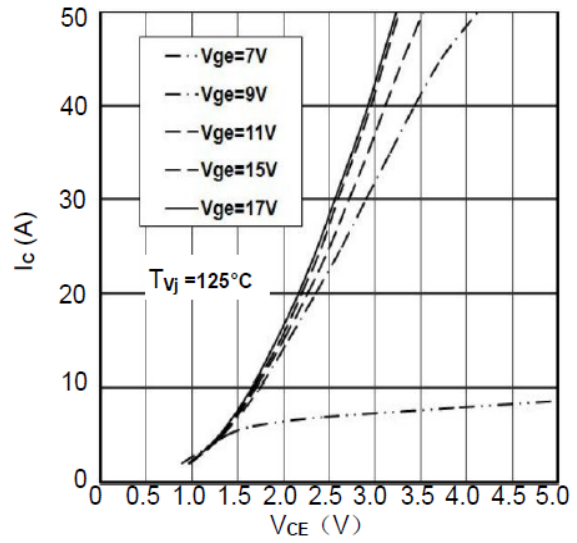

Figure2. Typical Output Characteristics

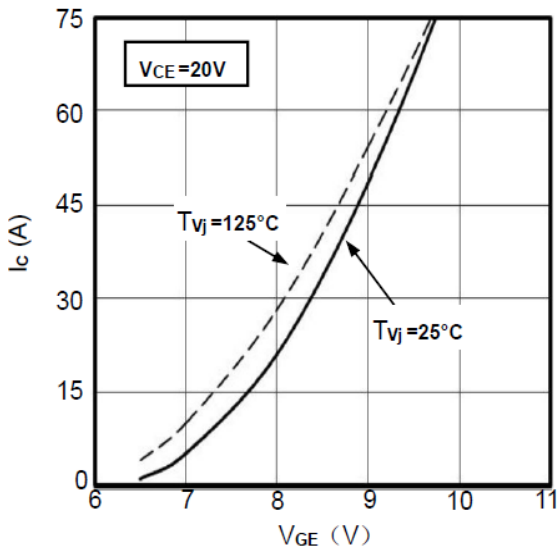

Figure3. Typical Transfer characteristics

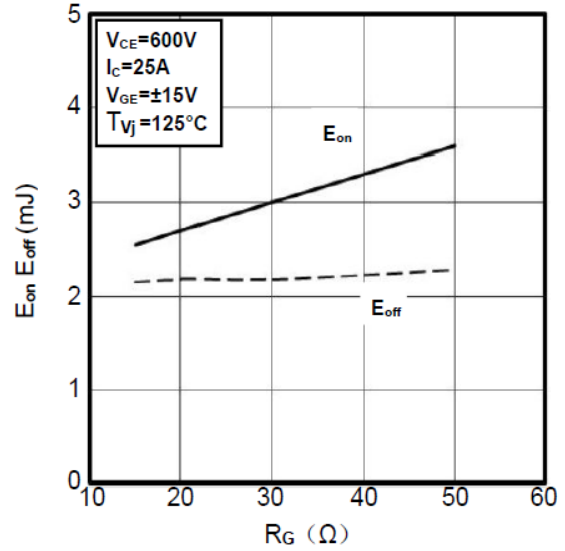

Figure4. Switching Energy vs. Gate Resistor

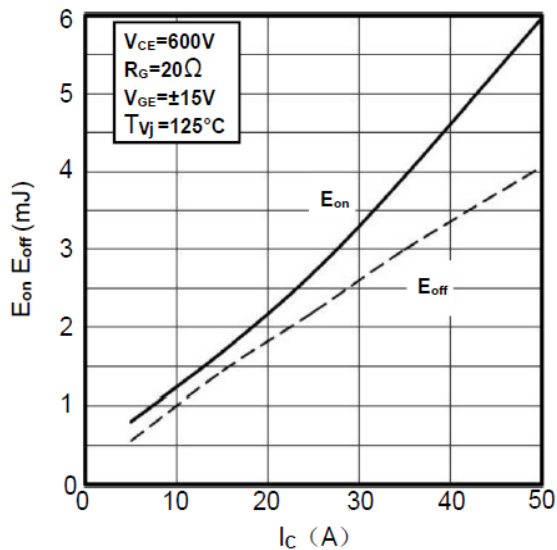

Figure5. Switching Energy vs. Collector Current

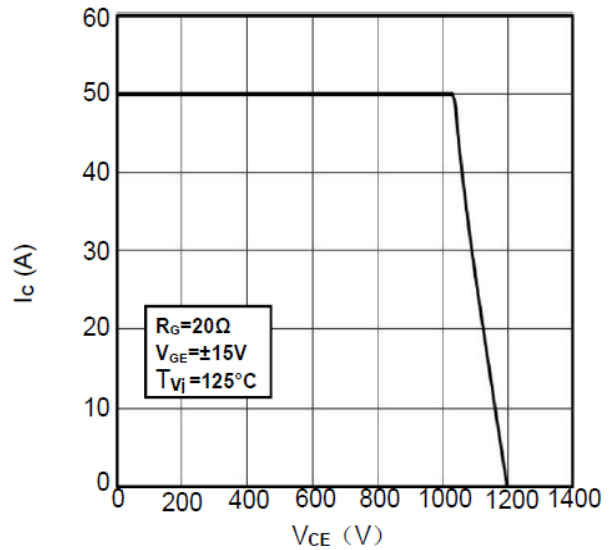

Figure6. Reverse Biased Safe Operating Area

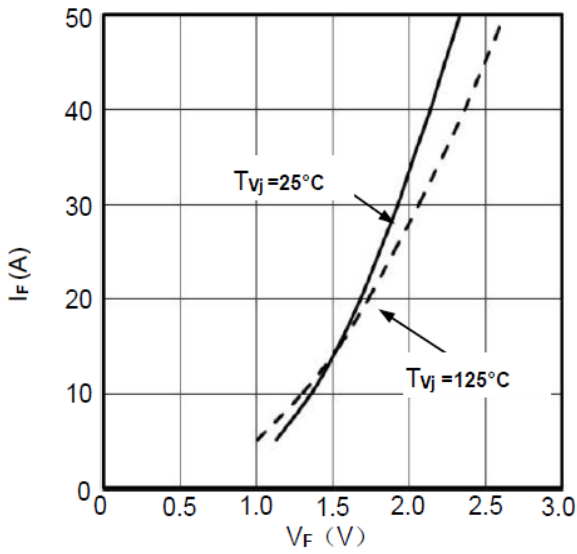

Figure7. Diode Forward Characteristics

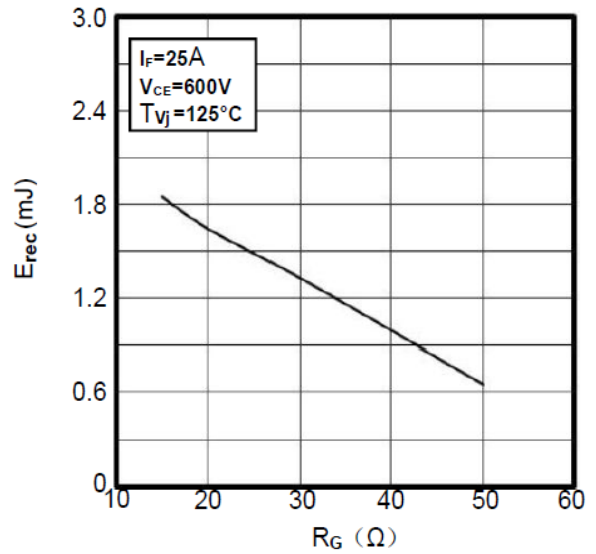

Figure8. Switching Energy vs. Gate Resistor

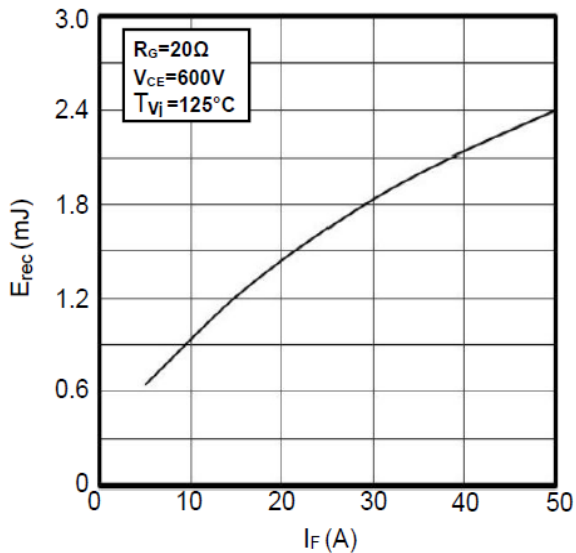

Figure9. Switching Energy vs. Forward Current

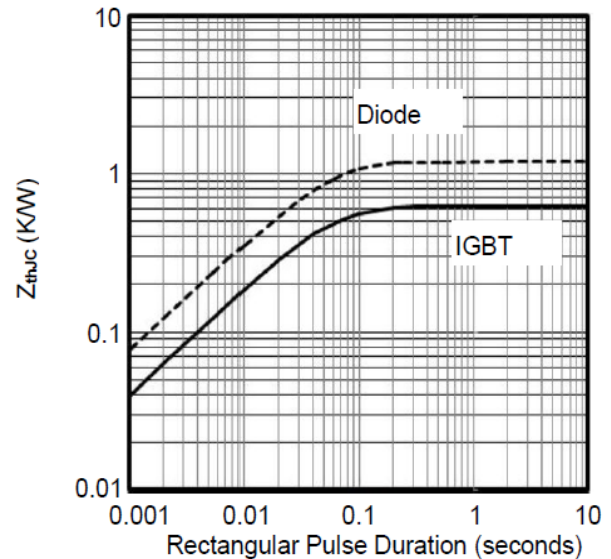

Figure10. Transient Thermal Impedance

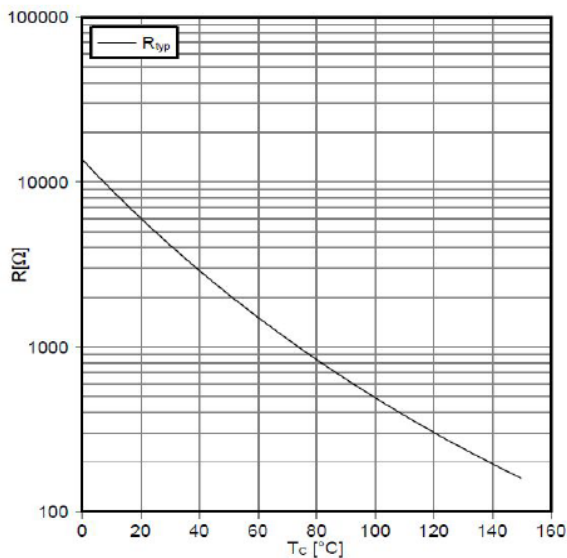

Figure11. NTC-Thermistor-temperature characteristic



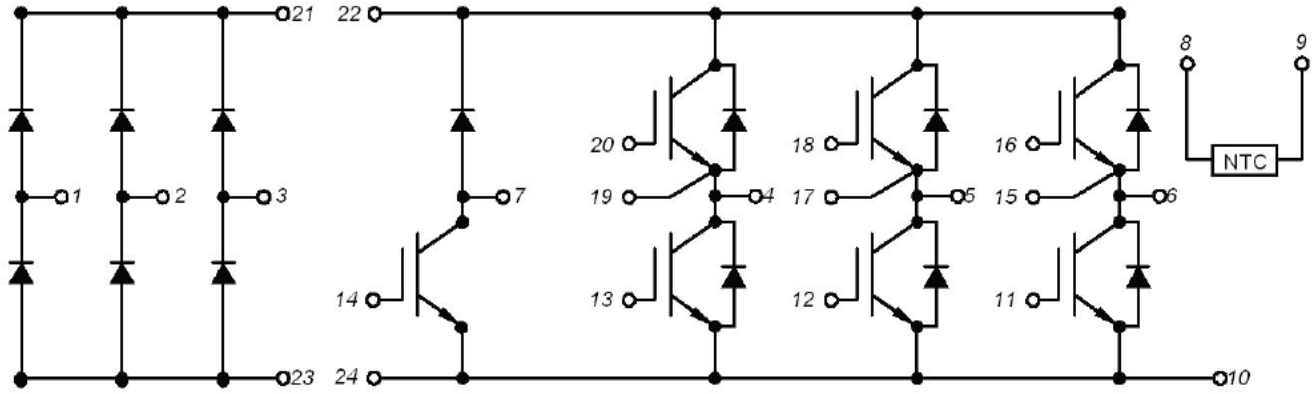

Figure11. Circuit Diagram

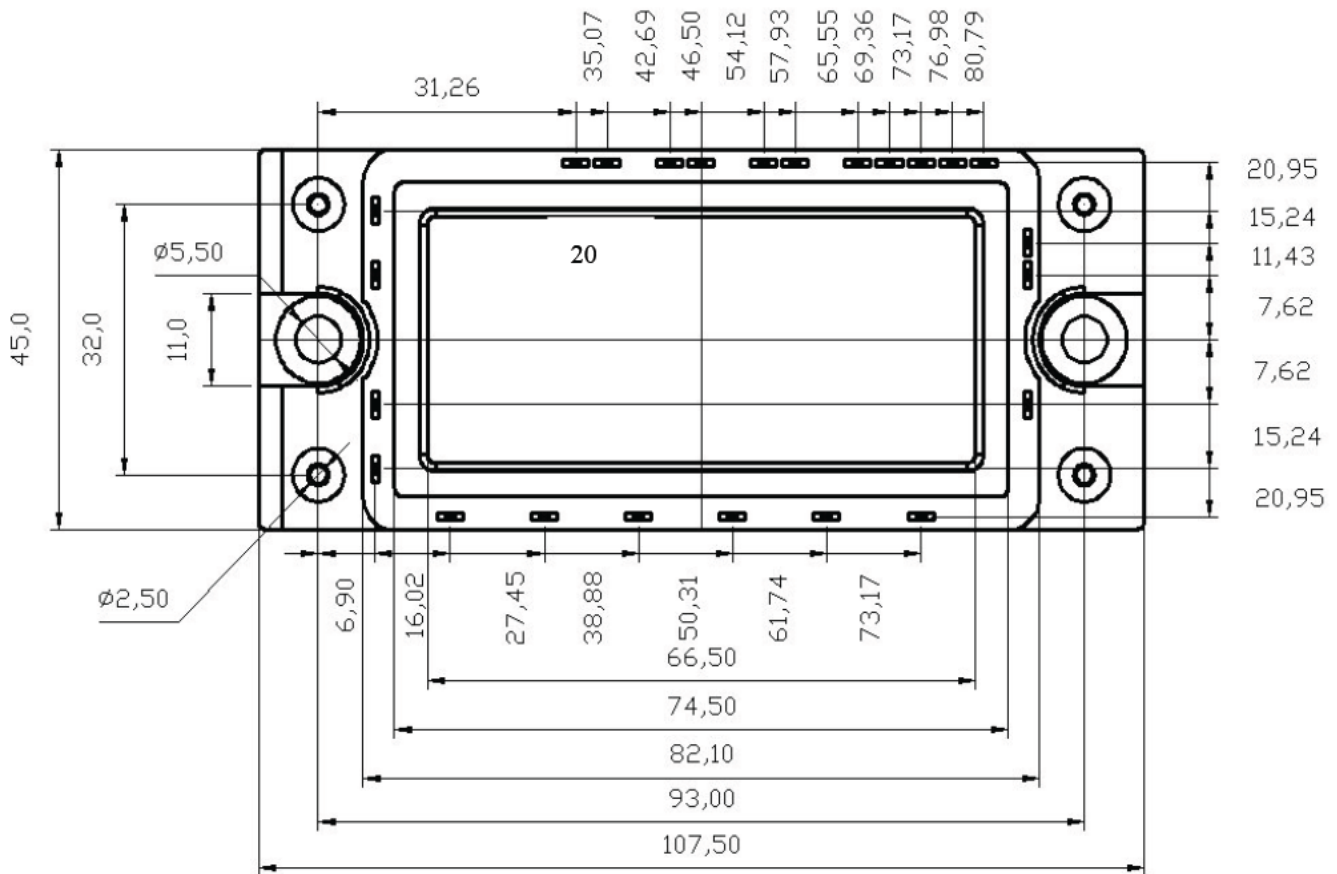
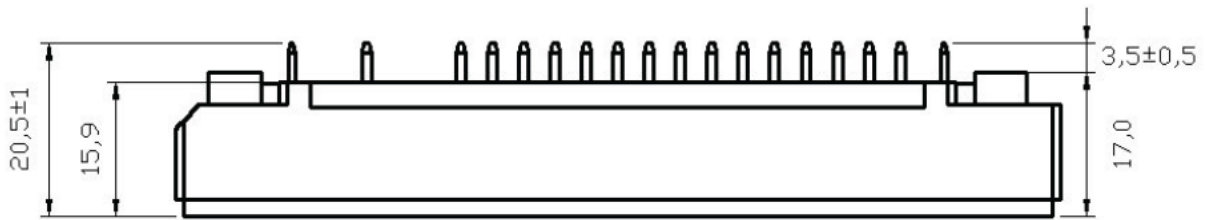

Figure12. Package Dimensions (mm)