

MLC Capacitors

Standard range - 10Vdc to 6kVdc

X8R High Temperature capacitors

TCC/VCC capacitors

High Q capacitors

Copper Barrier capacitors

Open Mode and Tandem capacitors

IECO-CECC range

AEC-Q200 range

S02A Space grade range

Safety Certified capacitors

250Vac Non Safety rated AC capacitors

115Vac 400Hz & DWV ranges

LCD Inverter chip range

E01 & E07 feedthrough chip capacitors

X2Y Integrated Passive Components

Radial Leaded capacitors



First in the market with flexible polymer terminations - the revolutionary FlexiCap™ capacitors - our capacitor range also includes X8R high temperature types, High Q capacitors and other application specific types. Our renowned high voltage MLCC expertise has led to the development of an impressive range with working voltage capability up to 10kV. This includes surface mount Class 'X' and 'Y' approved Safety Certified capacitors, 0603 chips with working voltages up to 500V, and 0805 types up to 1kV.

As part of the Dover Ceramic & Microwave Products group (CMP), we are able to offer unrivalled product quality with short lead-times, backed up by excellent sales and technical support. With a commitment to product innovation, new ranges are continually being developed.

Our experienced applications engineers are also available to provide custom solutions for specific applications. This catalogue details the standard ranges but we can provide items such as tight tolerance, low profile and non standard sizes on request. Flexibility is key, not only in design but in all aspects of customer service and support.

Our quality management systems meet international requirements, with approval to ISO 9001, environmental approval to ISO 14001 and Occupational Health and Safety approval to OHSAS 18001. Product approvals include, IECQ-CECC, UL, TÜV and qualification to AEC-Q200. SPC is used extensively, supported by Continuous Improvement Programmes, 6 Sigma projects and Lean Manufacturing initiatives.

Products

Syfer's excellence in ceramic materials technology, has enabled us to offer an unrivalled range of multilayer ceramic products including:

- Multilayer ceramic chip capacitors
- High voltage MLCCs
- FlexiCap™ capacitors with flexible terminations
- Class 'X' and 'Y' SMD Safety Certified capacitors
- Radial leaded capacitors
- AEC-Q200 qualified capacitors
- IECQ CECC approved capacitors and radials
- Capacitors for space applications
- High Q capacitors
- Non Magnetic capacitors
- 3 terminal EMI chips
- X2Y Integrated Passive Components
- Capacitors for medical applications

Benefits

- High quality and reliability
- World-leading high voltage expertise
- Suitable for the most demanding applications including: automotive, aerospace, military, space and medical
- Approvals to international specifications
- Continual product improvement and innovation
- Tight tolerances available
- Large case sizes, up to 8060
- Custom product capability
- Strong technical support
- Short lead-times
- Environmentally responsible

Suffix code controlled items such as Low profile, defined thickness and custom lead forms available by special request.

Other Syfer products

- Surface mount Pi filters
- Panel mount threaded filters
- Panel mount solder-in filters
- Custom filter assembly capability
- Varistor filters
- Discoidal capacitors
- Planar capacitor and planar varistor arrays
- EMI Power Filters
- Hermetically sealed EMI filters



Syfer - Innovative, World-Class Ceramic Capacitors

General introduction	
Definitions of Ultra-Stable and Stable	2
Dielectric characteristics	3
Capacitance, Impedance and E.S.R. vs Frequency	4
Ageing, capacitance measurements and tight tolerance capacitors	5
Production processes and reliability	6
FlexiCap™ overview	7
Testing and termination types	8
Documentation and compliance	9
IECQ-CECC and AEC-Q200 periodic tests	10
Handling notes	11
Soldering information	12
Chip dimensions	13
Product Selector	14-15

 Ceramic Chip capacitors	
Standard MLCC ranges - 10Vdc to 6kVdc - COG/NP0 & X7R	16-18
X8R High Temperature capacitors	19
TCC/VCC range	20-21
High Q capacitors - MS range	22-23
Copper Barrier capacitors	24-25
Open Mode & Tandem capacitors	26
IECQ-CECC ranges	27
AEC-Q200 ranges	28
S02A Space grade ranges	29
Safety Certified capacitors	30-32
250Vac Non Safety Rated AC capacitors	33
115Vac 400Hz & DWV ranges	34
LCD Inverter chip range	35

 Surface Mount EMI filters	
E01 & E07 feedthrough capacitors	36-37
X2Y Integrated Passive Components	38-39

Packaging information - Ceramic chip capacitors	40-41
---	-------

 Radial Leaded capacitors	42-47
Packaging information - Radial leaded capacitors	48-49

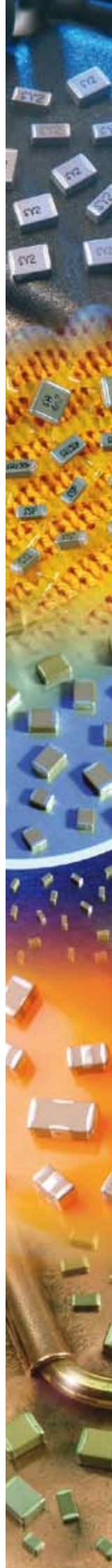

Notes: 1) Capacitance in F. 2) *These parts may require conformal coating post soldering. 3) T = Maximum thickness.

	10V			16V			25V			50/63V			100v		200/250V		500V		630V		1kV		1.2kV		1.5kV		2kV		2.5kV		3kV		4kV		5kV		6kV							
	COG/NPO	X7R	X5R	COG/NPO	X7R	X5R	COG/NPO	X7R	X5R	COG/NPO	X7R	X5R	COG/NPO	X7R	COG/NPO	X7R	COG/NPO	X7R	COG/NPO	X7R	COG/NPO	X7R	COG/NPO	X7R	COG/NPO	X7R	COG/NPO	X7R	COG/NPO	X7R	COG/NPO	X7R	COG/NPO	X7R	COG/NPO	X7R								
0603	0.47p 3.9n	100p 100n	120p 150n	0.47p 2.7n	100p 100n	120p	0.47p 2.2n	100p 100n	—	0.47p 1.5n	100p 47n	56n 68n	0.47p 470p	100p 33n	0.47p 220p	100p 10n	0.47p 150p*	100p 1.5n*	—	—	—	—	—	—	—	—	—	—	—	—	—	—	—	—	—	—	—	0603						
0805	1.0p 15n	100p 330n	390p 680n	1.0p 12n	100p 330n	390p 470n	1.0p 10n	100p 220n	270n 390n	1.0p 5.6n	100p 220n	270n 330n	1.0p 2.2n	100p 100n	1.0p 1n	100p 56n	1.0p 680p	100p 10n	1.0p 560p	100p 6.8n	180p 180p	1.0p 4.7n	120p	—	1.0p 82p	—	1.0p 39p	—	—	—	—	—	—	—	—	0805								
1206	1.0p 47n	100p 1.0μ	1.2μ 1.5μ	1.0p 33n	100p 1.0μ	1.2μ 1.2μ	1.0p 27n	100p 820n	1.0μ 1.0μ	1.0p 22n	100p 470n	560n 680n	1.0p 8.2n	100p 330n	1.0p 3.3n	100p 150n	1.0p 2.2n	100p 47n	1.0p 1.5n	100p 33n	1.0p 1.0n	100p 27n	1.0p 680p	100p 15n	1.0p 330p	1.0p 10n	100p 220p	1.0p 2.2n	100p 100p	—	1.0p 68p	—	—	—	—	1206								
1210	3.9p 100n	330p 1.5μ	1.8μ 3.3μ	3.9p 68n	330p 1.5μ	1.8μ 2.7μ	3.9p 56n	330p 1.2μ	1.5μ 2.2μ	3.9p 33n	330p 1.0μ	1.5μ 1.5μ	3.9p 18n	330p 680n	3.9p 8.2n	330p 330n	3.9p 6.8n	330p 120n	3.9p 3.9n	330p 3.9n	3.9p 47n	330p 2.2n	3.9p 33n	3.9p 1.5n	330p 10n	3.9p 820p	3.9p 6.8n	390p 4.7n	3.9p 220p	—	3.9p 150p	—	—	—	1210									
1808	4.7p 100n	100p 1.5μ	1.8μ 2.7μ	4.7p 68n	100p 1.5μ	1.8μ 2.2μ	4.7p 47n	100p 1.2μ	1.5μ 1.5μ	4.7p 33n	100p 680n	820n 1.0μ	4.7p 18n	100p 560n	4.7p 8.2n	100p 270n	4.7p 5.6n	100p 120n	4.7p 3.9n	100p 68n	4.7p 2.2n	100p 47n	4.7p 1.5n	100p 10n	4.7p 1.0n	100p 6.8n	4.7p 470p	4.7p 4.7n	100p 270p	4.7p 1.5n	180p 180p	4.7p 1.2n	120p* 120p*	100p 1.0n*	47p* 47p*	100p 680p*	4.7p 47p*	100p 390p*	1808					
1812 T=2.5mm	10p 220n	150p 3.3μ	3.9μ 10μ	10p 180n	150p 3.3μ	3.9μ 6.8μ	10p 150n	150p 2.2μ	2.7μ 4.7μ	10p 100n	150p 2.2μ	2.7μ 3.3μ	10p 47n	150p 1.5μ	10p 22n	150p 680n	10p 15n	150p 330n	10p 10n	150p 180n	10p 6.8n	150p 100n	10p 4.7n	150p 33n	10p 2.7n	150p 22n	10p 1.5n	150p 10n	10p 820p	10p 3.3n	150p 560p	10p 2.7n	150p 270p*	10p 2.2n*	150p 180p*	10p 1.2n*	150p 120p*	10p 1.0n*	150p 390p*	1812 (T=2.5mm)				
1812 T=3.2mm	—	—	—	—	—	—	—	—	—	—	—	—	—	—	27n	—	18n 22n	—	12n	—	8.2n	—	5.6n 6.8n	—	3.3n	—	1.8n	—	1.0n	—	680p	—	330p 390p*	—	220p 270p*	—	150p 180p*	—	1812 (T=3.2mm)					
1825 T=2.5mm	10p 470n	220p 4.7μ	5.6μ 15μ	10p 330n	220p 4.7μ	5.6μ 12μ	10p 220n	220p 3.9μ	4.7μ 10μ	10p 150n	220p 1.8μ	2.2μ 6.8μ	10p 68n	220p 1.5μ	10p 33n	220p 1.0μ	220p 27n	220p 560n	10p 22n	220p 180n	10p 12n	220p 120n	10p 6.8n	220p 68n	10p 4.7n	220p 3.3n	10p 27n	220p 1.8n	220p 8.2n	10p 1.5n	220p 6.8n	10p 1.2n	220p 3.9n	10p 560p*	220p 2.2n*	220p 390p*	10p 1.8n*	220p 270p*	10p 1.5n*	1825 (T=2.5mm)				
1825 T=3.2mm	—	—	—	—	—	—	—	—	—	—	—	—	—	—	39n 47n	—	33n	—	27n	—	15n	—	8.2n 10n	—	5.6n 6.8n	—	3.9n	—	1.8n 2.2n	—	1.5n	—	680p*	—	470p*	—	330p*	—	1825 (T=3.2mm)					
2220 T=2.5mm	10p 470n	220p 5.6μ	6.8μ 18μ	10p 330n	220p 5.6μ	6.8μ 12μ	10p 220n	220p 4.7μ	5.6μ 10μ	10p 150n	220p 3.3μ	3.9μ 6.8μ	10p 68n	220p 2.2μ	10p 33n	220p 1.0μ	220p 22n	220p 560n	10p 18n	220p 330n	10p 15n	220p 120n	10p 10n	220p 82n	10p 5.6n	220p 47n	10p 3.3n	220p 27n	10p 1.8n	220p 8.2n	10p 1.5n	220p 6.8n	10p 680p*	220p 4.7n*	220p 470p*	10p 3.9n*	220p 330p*	10p 2.2n*	2220 (T=2.5mm)					
2220 T=4.0mm	—	—	—	—	—	—	—	—	—	—	—	—	—	—	39n 56n	—	27n 39n	—	22n 33n	—	18n 22n	—	12n 15n	—	6.8n 10n	—	3.9n 5.6n	—	2.2n 3.3n	—	1.8n 2.2n	—	820p 1.2n*	—	560p 820p*	—	390p 560p*	—	2220 (T=4.0mm)					
2225 T=2.5mm	10p 560n	330p 6.8μ	8.2μ 22μ	10p 470n	330p 6.8μ	8.2μ 15μ	10p 330n	330p 5.6μ	6.8μ 12μ	10p 220n	330p 3.3μ	3.9μ 10μ	10p 82n	330p 2.7μ	10p 47n	330p 1.5μ	330p 33n	330p 820n	10p 22n	330p 390n	10p 18n	330p 150n	10p 12n	330p 100n	10p 6.8n	330p 68n	10p 4.7n	330p 33n	10p 2.2n	330p 12n	10p 1.8n	330p 8.2n	10p 820p*	330p 5.6n*	330p 560p*	10p 4.7n*	330p 390p*	10p 2.7n*	2225 (T=2.5mm)					
2225 T=4.0mm	—	—	—	—	—	—	—	—	—	—	—	—	—	—	56n 68n	—	39n 47n	—	27n 39n	—	22n 27n	—	15n 22n	—	8.2n 12n	—	5.6n 6.8n	—	2.7n 3.9n	—	2.2n 2.7n	—	1.0n 1.5n*	—	680p 820p*	—	470p 680p*	—	2225 (T=4.0mm)					
3640 T=2.5mm	—	—	—	—	—	—	—	—	—	—	—	—	—	—	10p 330n	470p 10μ	—	10p 270n	470p 5.6μ	10p 120n	470p 3.3μ	10p 82n	470p 180n	10p 33n	470p 150n	10p 22n	470p 100n	10p 10n	470p 47n	10p 6.8n	470p 33n	10p 4.7n	470p 22n	10p 1.8n	470p 6.8n	10p 1.5n	—	10p 1.0n	—	3640 (T=2.5mm)				
3640 T=4.0mm	—	—	—	—	—	—	—	—	—	—	—	—	—	—	150n 180n	—	100n 120n	—	82n 100n	—	56n 82n	—	39n 56n	—	27n 39n	—	12n 18n	—	8.2n 12n	—	5.6n 8.2n	—	2.2n 3.3n	—	1.8n 2.2n	—	1.2n 1.5n	—	3640 (T=4.0mm)					
5550 T=2.5mm	—	—	—	—	—	—	—	—	—	—	—	—	—	—	390p 680n	1.0n 15μ	—	390p 470n	1.0n 10μ	390p 270n	1.0n 5.6μ	390p 180n	1.0n 1.8μ	390p 120n	1.0n 1.2μ	390p 82n	1.0n 390n	1.0n 68n	390p 220n	1.0n 39n	390p 150n	1.0n 22n	390p 150n	1.0n 22n	390p 82n	1.0n 68n	390p 10n	1.0n 47n	390p 4.7n	1.0n 15n	390p 2.7n	1.0n 10n	390p 1.8n	5550 (T=2.5mm)
5550 T=4.0mm	—	—	—	—	—	—	—	—	—	—	—	—	—	—	330n	—	220n 270n	—	150n 180n	—	100n 150n	—	82n 100n	—	47n 68n	—	27n 39n	—	15n 22n	—	12n 18n	—	5.6n 6.8n	—	3.3n 4.7n	—	2.2n 3.3n	—	5550 (T=4.0mm)					
8060 T=2.5mm	—	—	—	—	—	—	—	—	—	—	—	—	—	—	680p 1.0μ	2.2n 22μ	—	680p 680n	2.2n 15μ	680p 390n	2.2n 10μ	680p 270n	2.2n 3.3μ	680p 220n	2.2n 150n	680p 1.0μ	680p 100n	2.2n 470n	680p 68n	2.2n 330n	680p 39n	680p 150n	2.2n 22n	680p 100n	2.2n 15n	680p 82n	2.2n 8.2n	680p 33n	2.2n 5.6n	680p 22n	2.2n 3.9n	8060 (T=2.5mm)		
8060 T=4.0mm	—	—	—	—	—	—	—	—	—	—	—	—	—	—	470n 560n	—	330n 470n	—	270n 390n	—	180n 270n	—	120n 180n	—	82n 120n	—	47n 68n	—	27n 39n	—	18n 27n	—	10n 15n	—	6.8n 10n	—	4.7n 6.8n	—	8060 (T=4.0mm)					





Note: 0402, 0505, 1111 & 2211 case sizes are available in our speciality ranges.

Please refer to the relevant sections of this catalogue for more details.

Syfer - Innovative, World-Class Ceramic Capacitors

- General introduction
- Definitions of Ultra-Stable and Stable **2**
- Dielectric characteristics **3**
- Capacitance, Impedance and E.S.R. vs Frequency **4**
- Ageing, capacitance measurements and tight tolerance capacitors **5**
- Production processes and reliability **6**
- FlexiCap™ overview **7**
- Testing and termination types **8**
- Documentation and compliance **9**
- IECQ-CECC and AEC-Q200 periodic tests **10**
- Handling notes **11**
- Soldering information **12**
- Chip dimensions **13**
- Product Selector **14-15**

-  Ceramic Chip capacitors
 - Standard MLCC ranges - 10Vdc to 6kVdc - COG/NPO & X7R **16-18**
 - X8R High Temperature capacitors **19**
 - TCC/VCC range **20-21**
 - High Q capacitors - MS range **22-23**
 - Copper Barrier capacitors **24-25**
 - Open Mode & Tandem capacitors **26**
 - IECQ-CECC ranges **27**
 - AEC-Q200 ranges **28**
 - S02A Space grade ranges **29**
 - Safety Certified capacitors **30-32**
 - 250Vac Non Safety Rated AC capacitors **33**
 - 115Vac 400Hz & DWV ranges **34**
 - LCD Inverter chip range **35**

-  Surface Mount EMI filters
 - E01 & E07 feedthrough capacitors **36-37**
 - X2Y Integrated Passive Components **38-39**

- Packaging information - Ceramic chip capacitors **40-41**

-  Radial Leaded capacitors **42-47**
- Packaging information - Radial leaded capacitors **48-49**

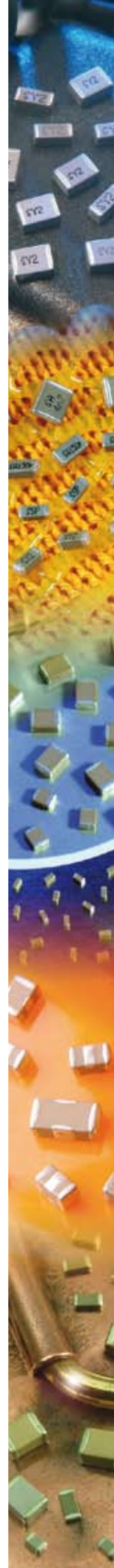

Multilayer Ceramic Capacitors are generally divided into classes which are defined by the capacitance temperature characteristics over specified temperature ranges. These are designated by alpha numeric codes. Code definitions are summarised below and are also available in the relevant national and international specifications.

COG/NPO - Ultra Stable Class 1 Ceramic (EIA Class 1)

Spec.	Classification	Temperature range °C	Maximum capacitance change @ rated DC volts	Syfer dielectric code
CECC	1B/CG	-55 +125	0 ± 30ppm/°C	C
EIA	COG/NPO	-55 +125	0 ± 30ppm/°C	C
MIL	CG (BP)	-55 +125	0 ± 30ppm/°C	C

Capacitors within this class have a dielectric constant range from 10 to 100. They are used in applications which require ultra stable dielectric characteristics with negligible dependence of capacitance and dissipation factor with time, voltage and frequency. They exhibit the following characteristics:-

- a) Time does not significantly affect capacitance and dissipation factor (Tan δ) – no ageing.
- b) Capacitance and dissipation factor are not affected by voltage.
- c) Linear temperature coefficient.

X8R, X7R and X5R - Stable Class II Ceramic (EIA Class II)

Spec.	Classification	Temperature range °C	Maximum capacitance change % over temperature range		Syfer dielectric code
			No DC volt applied	Rated DC Volt	
CECC	2C1	-55 +125	±20	+20 -30	R
	2R1	-55 +125	±15	- -	X
	2X1	-55 +125	±15	+15 -25	B
EIA	X8R	-55 +150	±15	- -	N
	X7R	-55 +125	±15	- -	X
	X5R	-55 +85	±15	- -	P
MIL	BX	-55 +125	±15	+15 -25	B
	BZ	-55 +125	±20	+20 -30	R

Capacitors of this type have a dielectric constant range of 1000-4000, and also have a non-linear temperature characteristic which exhibits a dielectric constant variation of less than ±15% (2R1) from its room temperature value, over the specified temperature range. Generally used for by-passing (decoupling), coupling, filtering, frequency discrimination, DC blocking and voltage transient suppression

with greater volumetric efficiency than Class I units, whilst maintaining stability within defined limits. Capacitance and dissipation factor are affected by:-
 Time (Ageing)
 Voltage (AC or DC)
 Frequency

Typical dielectric temperature characteristics

COG/NPO capacitance vs temperature

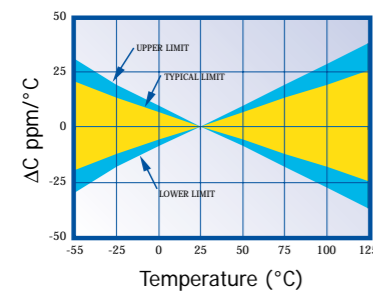

X7R capacitance vs temperature

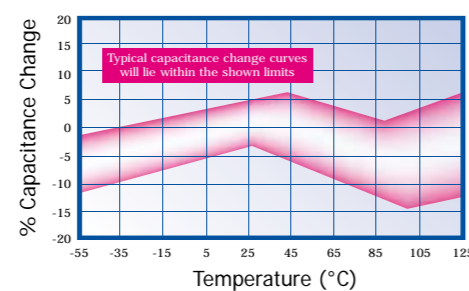

Power ratings

COG/NPO and X7R

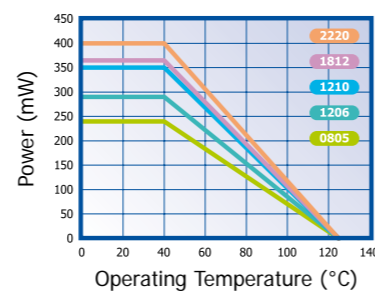

Technical Summary

Dielectric characteristics	COG/NPO			X5R	X7R			X8R
	Ultra stable			Stable	Stable			Stable
IECQ-CECC EIA MIL	1B/CG	-	-	-	2C1	2R1	2X1	-
	-	COG/NPO	-	X5R	-	X7R	-	X8R
	-	-	CG (BP)	-	BZ	-	BX	-
Rated temperature range	-55°C to +125°C			-55°C to +85°C	-55°C to +125°C			-55°C to +150°C
Maximum capacitance change over temperature range No DC voltage applied	0 ± 30 ppm/°C			± 15%	± 20%	± 15%	± 15%	± 15%
Rated DC voltage applied				-	+20 -30%	-	+15 -25%	-
Syfer dielectric ordering code	C			P	R	X	B	N
Tangent of loss angle (tan δ)	Cr > 50pF ≤ 0.0015 Cr ≤ 50pF = 0.0015 (15 + 0.7/Cr)			≤ 0.025	≤ 0.025			≤ 0.025
Insulation resistance (Ri) Time constant (Ri x Cr) (whichever is the least)	100G Ω or 1000s			100G Ω or 1000s	100G Ω or 1000s			100G Ω or 1000s
Capacitance tolerance	Cr < 10pF	± 0.05pF (H) ± 0.10pF (B) ± 0.25pF (C) ± 0.50pF (D) ± 1.0pF (F)		± 5% (J) ± 10% (K) ± 20% (M)	± 5% (J) ± 10% (K) ± 20% (M)	± 5% (J) ± 10% (K) ± 20% (M)		± 5% (J) ± 10% (K) ± 20% (M)
	Cr ≥ 10pF	± 1% (F) ± 2% (G) ± 5% (J) ± 10% (K)						
Dielectric strength	Voltage applied for 5 seconds. Charging current limited to 50mA maximum.							
≤200V	2.5 times	2.5 times		2.5 times	2.5 times		2.5 times	2.5 times
>200V to <500V	Rated voltage + 250V	-		Rated voltage + 250V	-		Rated voltage + 250V	-
500V to ≤1000V	1.5 times	-		-	-		-	-
500V to <1000V	-	-		-	-		1.5 times	-
>1kV to ≤1200V	1.25 times	-		-	-		-	-
>1200V	1.2 times	-		-	-		-	-
≥1000V	-	-		-	-		1.2 times	-
Climatic category (IEC)								
Chip	55/125/56			55/85/56	55/125/56			55/150/56
Dipped	55/125/21			-	55/125/21			-
Discoidal	55/125/56			-	55/125/56			-
Ageing characteristic (Typical)	Zero			<2% per time decade	<2% per time decade			<2% per time decade

The table above highlights the difference in coding for IECQ-CECC, EIA and MIL standards when defining the temperature coefficient and the voltage coefficient.

Approvals

Chip	QC-32100	-	QC-32100	-
Dipped radial	IECQ-CECC 30601-008	-	IECQ-CECC 30701-013	-

Impedance vs Frequency - chips

Ultra Stable COG/NP0 dielectric

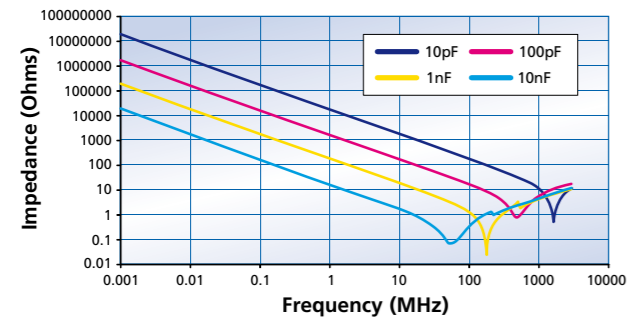

ESR vs Frequency - chips

Ultra Stable COG/NP0 dielectric

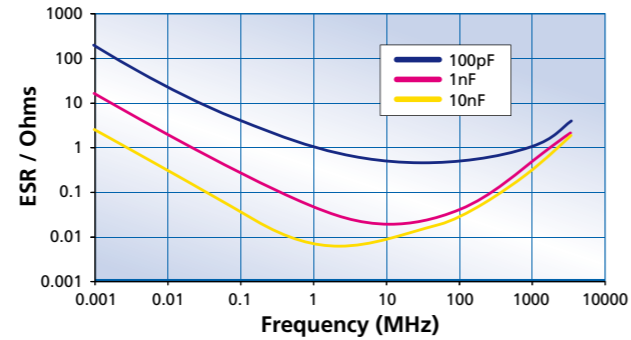

Stable X7R dielectric

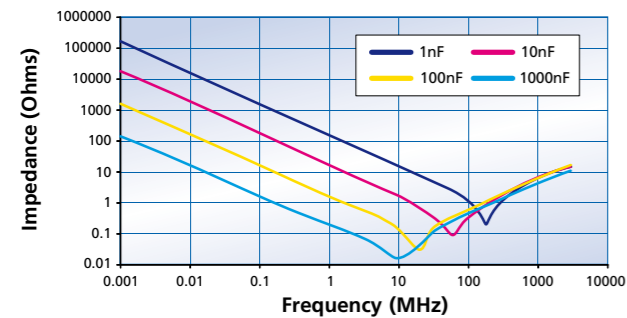

Stable X7R dielectric

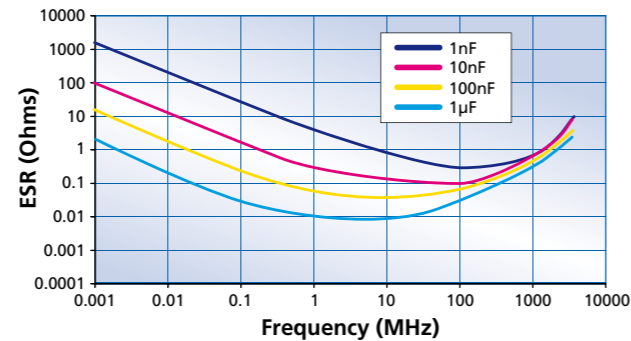

Impedance vs Frequency - 10nF chips

Stable X7R dielectric

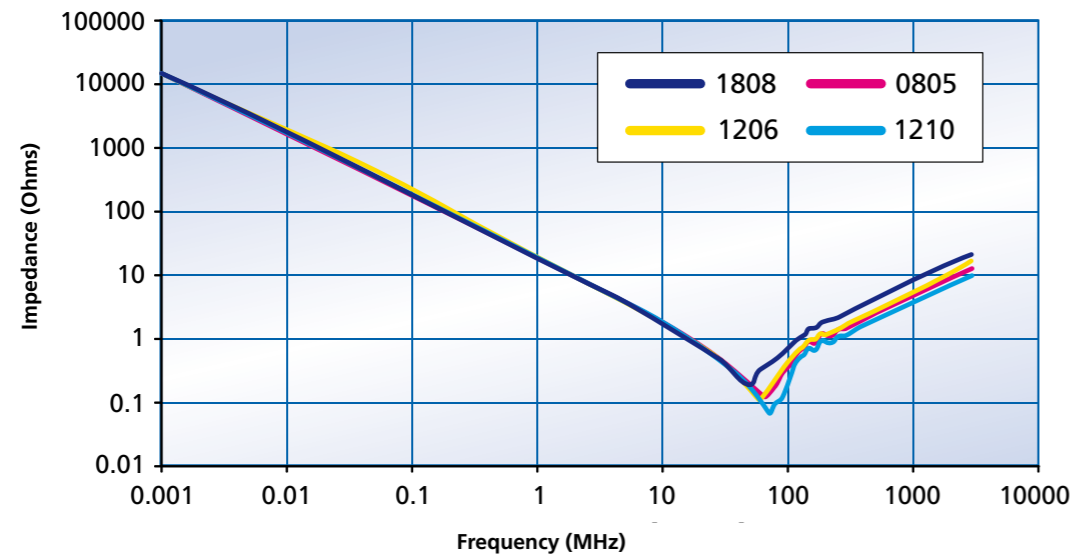

Ageing

Capacitor ageing is a term used to describe the negative, logarithmic capacitance change which takes place in ceramic capacitors with time. The crystalline structure for barium titanate based ceramics changes on passing through its Curie temperature (known as the Curie Point) at about 125°C. This domain structure relaxes with time and in doing so, the dielectric constant reduces logarithmically; this is known as the ageing mechanism of the dielectric constant. The more stable dielectrics have the lowest ageing rates.

The ageing process is reversible and repeatable. Whenever the capacitor is heated to a temperature above the Curie Point the ageing process starts again from zero.

The ageing constant, or ageing rate, is defined as the percentage loss of capacitance due to the ageing process of the dielectric which occurs during a decade of time (a tenfold increase in age) and is expressed as percent per logarithmic decade of hours. As the law of decrease of capacitance is logarithmic, this means that in a capacitor with an ageing rate of 1% per decade of time, the capacitance will decrease at a rate of:

- a) 1% between 1 and 10 hours
- b) An additional 1% between the following 10 and 100 hours
- c) An additional 1% between the following 100 and 1000 hours
- d) An additional 1% between the following 1000 and 10000 hours etc
- e) The ageing rate continues in this manner throughout the capacitor's life.

Typical values of the ageing constant for our Multilayer Ceramic Capacitors are:

Dielectric class	Typical values
Ultra Stable COG/NP0	Negligible capacitance loss through ageing
Stable X7R	<2 % per decade of time

Capacitance measurements

Because of ageing it is necessary to specify an age for reference measurements at which the capacitance shall be within the prescribed tolerance. This is fixed at 1000 hours, since for practical purposes there is not much further loss of capacitance after this time.

All capacitors shipped are within their specified tolerance at the standard reference age of 1000 hours after having cooled through their Curie temperature.

The ageing curve for any ceramic dielectric is a straight line when plotted on semi-log paper.

Capacitance vs time

(Ageing X7R @ 1% per decade)

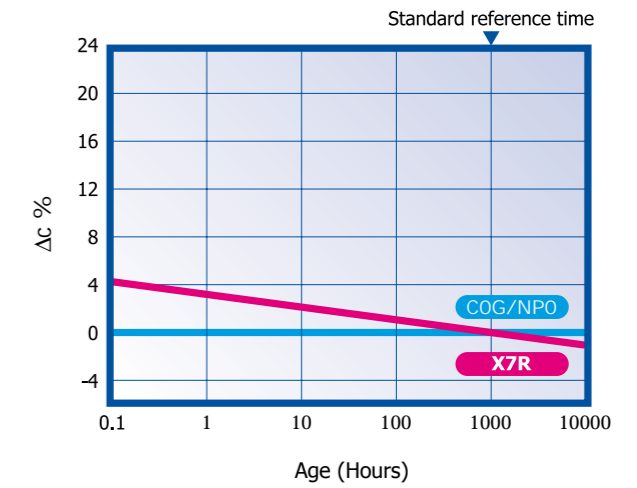

Tight tolerance

One of the advantages of Syfer's unique 'wet process' of manufacture is the ability to offer capacitors with exceptionally tight capacitance tolerances.

The accuracy of the printing screens used in the fully automated, computer controlled manufacturing process allows for tolerance as close as +/-1% on COG/NP0 parts greater than or equal to 10pF. For capacitance values below 10pF, tolerances can be as tight as +/-0.05pF.

Production process flowchart

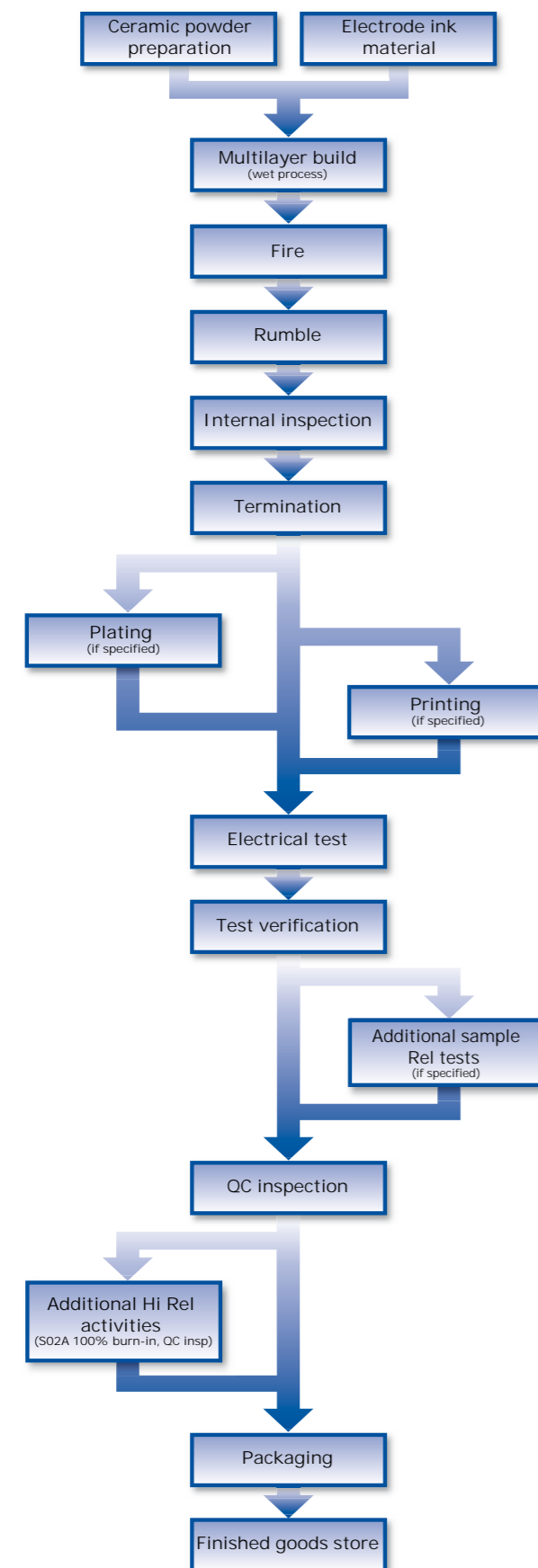

Syfer reliability grades

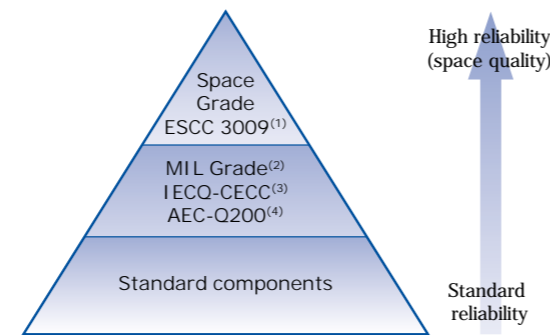

Notes:

- (1) Space grade tested in accordance with ESCC 3009. Refer to Syfer specification SO2A 0100.
- (2) MIL Grade. Released in accordance with US standards available on request.
- (3) IECQ-CECC. The International Electrotechnical Commission (IEC) Quality Assessment System for Electronic Components. This is an internationally recognised product quality certification which provides customers with assurance that the product supplied meets high quality standards. View Syfer's IECQ-CECC approvals at <http://www.iecq.org> or at www.syfer.com
- (4) AEC-Q200. Automotive Electronics Council Stress Test Qualification For Passive Components. Refer to Syfer application note reference AN0009.

Syfer reliability surface mount product groups

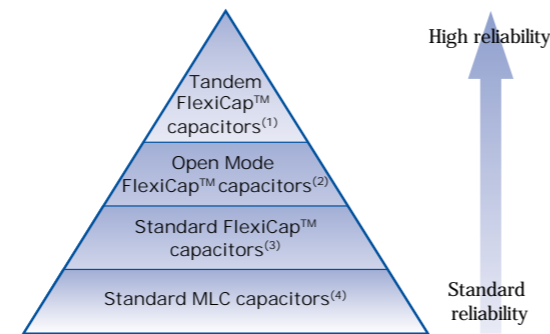

Notes:

- (1) "Tandem" construction capacitors, ie internally having the equivalent of 2 series capacitors. If one of these should fail short-circuit, there is still capacitance end to end and the chip will still function as a capacitor, although capacitance maybe affected. Refer to application note AN0021. Also available qualified to AEC-Q200.
- (2) "Open Mode" capacitors with FlexiCap™ termination also reduce the possibility of a short circuit by utilising inset electrode margins. Refer to application note AN0022. Also available qualified to AEC-Q200.
- (3) Multilayer capacitors with Syfer FlexiCap™ termination. By using FlexiCap™ termination, there is a reduced possibility of the mechanical cracking occurring.
- (4) "Standard" capacitors includes MLCCs with tin finish over nickel, but no FlexiCap™.

FlexiCap™ termination

MLCCs are widely used in electronic circuit design for a multitude of applications. Their small package size, technical performance and suitability for automated assembly makes them the component of choice for the specifier.

However, despite the technical benefits, ceramic components are brittle and need careful handling on the production floor. In some circumstances they may be prone to mechanical stress damage if not used in an appropriate manner. Board flexing, depanelisation, mounting through hole components, poor storage and automatic testing may all result in cracking.

Careful process control is important at all stages of circuit board assembly and transportation - from component placement to test and packaging. Any significant board flexing may result in stress fractures in ceramic devices that may not always be evident during the board assembly process. Sometimes it may be the end customer who finds out - when equipment fails!

Syfer has the solution - FlexiCap™

FlexiCap™ has been developed as a result of listening to customers' experiences of stress damage to MLCCs from many manufacturers, often caused by variations in production processes.

Our answer is a proprietary flexible epoxy polymer termination material, that is applied to the device under the usual nickel barrier finish. FlexiCap™ will accommodate a greater degree of board bending than conventional capacitors.

Syfer FlexiCap™ termination

All ranges are available with FlexiCap™ termination material offering increased reliability and superior mechanical performance (board flex and temperature cycling) when compared with standard termination materials. Refer to Syfer application note reference AN0001. FlexiCap™ capacitors enable the board to be bent almost twice as much before mechanical cracking occurs. Refer to application note AN0002.

FlexiCap™ is also suitable for Space applications having passed thermal vacuum outgassing tests. Refer to Syfer application note reference AN0026.

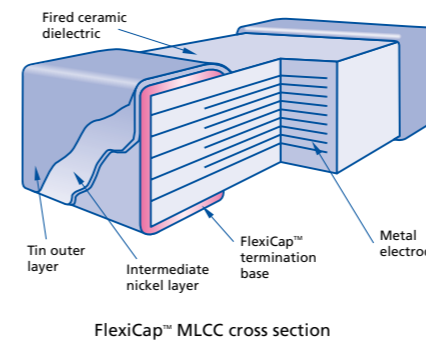

FlexiCap™ benefits

With traditional termination materials and assembly, the chain of materials from bare PCB to soldered termination, provides no flexibility. In circumstances where excessive stress is applied - the weakest link fails. This means the ceramic itself, which may fail short circuit.

The benefit to the user is to facilitate a wider process window - giving a greater safety margin and substantially reducing the typical root causes of mechanical stress cracking.

FlexiCap™ may be soldered using your traditional wave or reflow solder techniques and needs no adjustment to equipment or current processes.

Syfer has delivered millions of FlexiCap™ components and during that time has collected substantial test and reliability data, working in partnership with customers world wide, to eliminate mechanical cracking.

An additional benefit of FlexiCap™ is that MLCCs can withstand temperature cycling -55°C to 125°C in excess of 1,000 times without cracking.

FlexiCap™ termination has no adverse effect on any electrical parameters, nor affects the operation of the MLCC in any way.

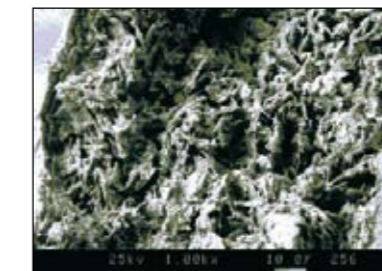

Picture taken at 1,000x magnification using a SEM to demonstrate the fibrous nature of the FlexiCap™ termination that absorbs increased levels of mechanical stress.

Available on the following ranges:

- All High Reliability ranges
- Standard and High Voltage chips
- Safety Certified capacitor chips
- 3 terminal EMI chips
- X2Y Integrated Passive Components
- X8R High Temperature capacitors

Summary of PCB bend test results

The bend tests conducted on X7R have proven that the FlexiCap™ termination withstands a greater level of mechanical stress before mechanical cracking occurs.

The AEC-Q200 test for X7R requires a bend level of 2mm minimum and a cap change of less than 10%.

Product X7R	Typical bend performance under AEC-Q200 test conditions
Standard termination	2mm to 3mm
FlexiCap™	Typically 8mm to 10mm

Application notes

FlexiCap™ may be handled, stored and transported in the same manner as standard terminated capacitors. The requirements for mounting and soldering FlexiCap™ are the same as for standard SMD capacitors.

For customers currently using standard terminated capacitors there should be no requirement to change the assembly process when converting to FlexiCap™.

Based upon board bend tests in accordance with IEC 60384-1 the amount of board bending required to mechanically crack a FlexiCap™ terminated capacitor is significantly increased compared with standard terminated capacitors.

It must be stressed however, that capacitor users must not assume that the use of FlexiCap™ terminated capacitors will totally eliminate mechanical cracking. Good process controls are still required for this objective to be achieved.



Tests conducted during batch manufacture

	Syfer reliability SM product group			
	Standard SM capacitors	IECQ-CECC / MIL grade	AEC-Q200	S (Space grade) High Rel S02A
Solderability	●	●	●	●
Resistance to soldering heat	●	●	●	●
Plating thickness verification (if plated)	●	●	●	●
DPA (Destructive Physical Analysis)	●	●	●	●
Voltage proof test (DWV / Flash)	●	●	●	●
Insulation resistance	●	●	●	●
Capacitance test	●	●	●	●
Dissipation factor test	●	●	●	●
100% visual inspection	○	○	●	●
100% burn-in. (2xRV @125°C for 168 hours)	○	○	○	●
Load sample test @ 125°C	○	○	○	LAT1 & LAT2 (1000 hours)
Humidity sample test. 85°C/85%RH	○	○	○	240 hours
Hot IR sample test	○	○	○	○
Axial pull sample test (MIL-STD-123)	○	○	○	○
Breakdown voltage sample test	○	○	○	○
Deflection (bend) sample test	○	○	○	○
SAM (Scanning Acoustic Microscopy)	○	○	○	○
LAT1 (4 x adhesion, 8 x rapid temp change + LAT2 and LAT3)	-	-	-	○
LAT2 (20 x 1000 hour life test + LAT3)	-	-	-	○
LAT3 (6 x TC and 4 x solderability)	-	-	-	○

- Test conducted as standard.
- Optional test. Please discuss with Syfer Sales.

Termination types available

	Syfer reliability SM product group			
	Standard SM capacitors	IECQ-CECC / MIL grade	AEC-Q200	S (space grade) High Rel S02A
F: Silver Palladium	●	●	-	●
J: Silver base with nickel barrier (100% matte tin plating)	●	●	COG/NP0 dielectric only	○
A: Silver base with nickel barrier (tin/lead plating with min 10% lead)	●	●	-	●
Y: FlexiCap™ with nickel barrier (100% matte tin plating)	●	●	●	○
H: FlexiCap™ with nickel barrier (tin/lead plating with min 10% lead)	●	●	-	○
2: Silver base with Copper Barrier (100% matte tin plating)	● ⁽¹⁾	-	-	-
3: FlexiCap™ with Copper Barrier (100% matte tin plating)	● ⁽²⁾	-	-	-

- Notes:
- (1) Available on COG/NP0 and High Q only.
 - (2) Available on all dielectrics.
 - Termination available.
 - Termination available but generally not requested for space grade components. Please discuss with Syfer Sales.

Release documentation

	Syfer reliability SM product group			
	Standard SM capacitors	IECQ-CECC	AEC-Q200 MIL grade	S (Space grade) High Rel S02A
Certificate of conformance	●	-	●	●
IECQ-CECC Release certificate of conformity	-	●	-	-
Batch electrical test report	○	○	○	Included in data pack
S (space grade) data documentation package	-	-	-	●

- Release documentation supplied as standard.
- Original documentation.

Periodic tests conducted and reliability data availability

Standard Surface Mount c apacitors

Components are randomly selected on a sample basis and the following routine tests are conducted:

- Load Test. 1,000 hours @125°C (150°C for X8R). Applied voltage depends on components tested.
- Humidity Test. 168 hours @ 85°C/85%RH.
- Board Deflection (bend test).

Test results are available on request.

Conversion factors

From	To	Operation
FITS	MTBF (hours)	10 ⁹ ÷ FITS
FITS	MTBF (years)	10 ⁹ ÷ (FITS x 8760)

FITS = Failures in 10⁹ hours.
MTBF = Mean time between failures.

REACH (Registration, Evaluation, Authorisation and restriction of Chemicals) statement

The main purpose of REACH is to improve the protection of human health and the environment from the risks arising from the use of chemicals.

Syfer Technology Ltd maintains both ISO14001, Environmental Management System and OHSAS 18001 Health and Safety Management System approvals that require and ensure compliance with corresponding legislation such as REACH.

For further information, please contact Syfer at sales@syfer.co.uk

RoHS compliance

Syfer routinely monitors world wide material restrictions (e.g. EU / China & Korea RoHS mandates) and is actively involved in shaping future legislation.

Export controls and dual-use regulations

Certain Syfer catalogue components are defined as 'dual-use' items under international export controls - those that can be used for civil or military purposes which meet certain specified technical standards.

The defining criteria for a dual-use component with respect to Syfer products is one with a voltage rating of >750V and a capacitance value >250nF and a series inductance <10nH. Components defined as 'dual-use' under the above criteria

Example of FIT (Failure In Time) data available:

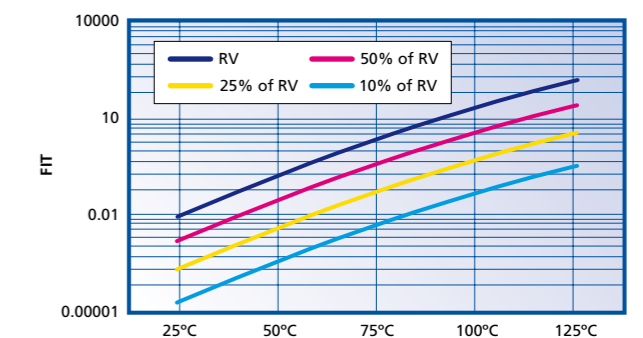

Component type: 0805 (COG/NP0 and X7R).
Testing location: Syfer reliability test department.
Results based on: 16,622,000 component test hours.

All standard Syfer MLCC products are compliant with the EU RoHS directive 2002/95/EC (see below for special exceptions) and those with plated terminations are suitable for soldering using common Pb free solder alloys (refer to 'Soldering Information' for more details on soldering limitations). Compliance with EU 2002/95/EC automatically signifies compliance with some other legislation (e.g. Korea RoHS). Please refer to Syfer for details of compliance with other materials legislation

Breakdown of material content, SGS analysis reports and tin whisker test results are available on request.

Most Syfer MLCC components are available with non RoHS compliant tin lead (SnPb) solderable termination finish by special request for exempt applications and where pure tin is not acceptable. Other tin free termination finishes may also be available – please refer to Syfer for further details.

Radial components have tin plated leads as standard, but tin/lead is available as a special option. Please refer to the radial section of the catalogue for further details.

automatically require a licence for export outside the EU, and may require a licence for export within the EU.

The application for a licence is routine, but customers for these products will be asked to supply further information.

Please refer to sales if you require any further information on export restrictions.

Other special components may additionally need to comply with export regulations.

Periodic tests conducted for IECQ-CECC and AEC-Q200

Test ref	Test	Termination type	Additional requirements	Sample acceptance			Reference
				P	n	c	
P1	High temperature exposure (storage)	All types	Un-powered. 1,000 hours @ T=150°C. Measurement at 24 ± 2 hours after test conclusion	12	77	0	MIL-STD-202 Method 108
P2	Temperature cycling	COG/NPO: All types X7R: Y and H only	1,000 cycles -55°C to +125°C. Measurement at 24 ± 2 hours after test conclusion	12	77	0	JESD22 Method JA-104
P3	Moisture resistance	All types	T = 24 hours/cycle. Note: Steps 7a and 7b not required. Un-powered. Measurement at 24 ± 2 hours after test conclusion	12	77	0	MIL-STD-202 Method 106
P4	Biased humidity	All types	1,000 hours 85°C/85%RH. Rated voltage or 50V whichever is the least and 1.5V. Measurement at 24 ± 2 hours after test conclusion	12	77	0	MIL-STD-202 Method 103
P5	Operational life	All types	Condition D steady state TA=125°C at full rated. Measurement at 24 ± 2 hours after test conclusion	12	77	0	MIL-STD-202 Method 108
P6	Resistance to solvents	All types	Note: Add aqueous wash chemical. Do not use banned solvents	12	5	0	MIL-STD-202 Method 215
P7	Mechanical shock	COG/NPO: All types X7R: Y and H only	Figure 1 of Method 213. Condition F	12	30	0	MIL-STD-202 Method 213
P8	Vibration	COG/NPO: All types X7R: Y and H only	5g's for 20 minutes, 12 cycles each of 3 orientations. Note: Use 8" x 5" PCB 0.031" thick 7 secure points on one long side and 2 secure points at corners of opposite sides. Parts mounted within 2" from any secure point. Test from 10-2,000Hz	12	30	0	MIL-STD-202 Method 204
P9	Resistance to soldering heat	All types	Condition B, no pre-heat of samples: Single wave solder - Procedure 2	3	12	0	MIL-STD-202 Method 210
P10	Thermal shock	COG/NPO: All types X7R: Y and H only	-55°C/+125°C. Number of cycles 300. Maximum transfer time - 20 seconds, dwell time - 15 minutes. Air-Air	12	30	0	MIL-STD-202 Method 107
P11	Adhesion, rapid temp change and climatic sequence	X7R: A, F and J only	5N force applied for 10s, -55°C/ +125°C for 5 cycles, damp heat cycles	12	27	0	BS EN132100 Clause 4.8, 4.12 and 4.13
P12	Board flex	COG/NPO: All types X7R: Y and H only	3mm deflection Class I 2mm deflection Class II	12	30	0	AEC-Q200-005
P13		X7R: A, F and J only	1mm deflection.	12	12	0	BS EN132100 Clause 4.9
P14	Terminal strength	All types	Force of 1.8kg for 60 seconds	12	30	0	AEC-Q200-006
P15	Beam load test	All types	-	12	30	0	AEC-Q200-003
P16	Damp heat steady state	All types	56 days, 40°C / 93% RH 15x no volts, 15x 5Vdc, 15x rated voltage or 50V whichever is the least.	12	45	0	BS EN132100 Clause 4.14

Test results are available on request.
P = Period in months.
N = Sample size.
C = Acceptance criteria.

Detailed application notes intended to guide and assist our customers in using multilayer ceramic capacitors in surface mount technology are available on the Syfer website www.syfer.com

The information concentrates on the handling, mounting, connection, cleaning, test and re-work requirements particular to MLC's for SMD technology, to ensure a suitable match between component capability and user expectation. Some extracts are given below.

Handling

Ceramics are dense, hard, brittle and abrasive materials. They are liable to suffer mechanical damage, in the form of chips or cracks, if improperly handled.

Terminations may be abraded onto chip surfaces if loose chips are tumbled in bulk. Metallic tracks may be left on the chip surfaces which might pose a reliability hazard.

Components should never be handled with fingers; perspiration and skin oils can inhibit solderability and will aggravate cleaning.

Chip capacitors should never be handled with metallic instruments. Metal tweezers should never be used as these can chip the product and may leave abraded metal tracks on the product surface. Plastic or plastic coated metal types are readily available and recommended - these should be used with an absolute minimum of applied pressure.

Counting or visual inspection of chip capacitors is best performed on a clean glass or hard plastic surface.

If chips are dropped or subjected to rough handling, they should be visually inspected before use. Electrical inspection may also reveal gross damage via a change in capacitance, an increase in dissipation factor or a decrease either in insulation resistance or electrical strength.

Transportation

Where possible, any transportation should be carried out with the product in its unopened original packaging. If already opened, any environmental control agents supplied should be returned to packaging and the packaging re-sealed.

Avoid paper and card as a primary means of handling, packing, transportation and storage of loose components. Many grades have a sulphur content which will adversely affect termination solderability.

Loose chips should always be packed with sulphur-free wadding to prevent impact or abrasion damage during transportation.

Storage

Incorrect storage of components can lead to problems for the user. Rapid tarnishing of the terminations, with an associated degradation of solderability, will occur if the product comes into contact with industrial gases such as sulphur dioxide and chlorine. Storage in free air, particularly moist or polluted air, can result in termination oxidation.

Packaging should not be opened until the MLC's are required for use. If opened, the pack should be re-sealed as soon as is practicable. Alternatively, the contents could be kept in a sealed container with an environmental control agent.

Long term storage conditions, ideally, should be temperature controlled between -5 and +40°C and humidity controlled between 40 and 60% R.H.

Taped product should be stored out of direct sunlight, which might promote deterioration in tape or adhesive performance.

Product, stored under the conditions recommended above, in its "as received" packaging, has a minimum shelf life of 2 years.

Mechanical considerations for mounted ceramic chip capacitors

Due to their brittle nature, ceramic chip capacitors are more prone to excesses of mechanical stress than other components used in surface mounting.

One of the most common causes of failure is directly attributable to bending the printed circuit board after solder attachment. The excessive or sudden movement of the flexible circuit board stresses the inflexible ceramic block causing a crack to appear at the weakest point, usually the ceramic/termination interface. The crack may initially be quite small and not penetrate into the inner electrodes; however, subsequent handling and rapid changes in temperature may cause the crack to enlarge.

This mode of failure is often invisible to normal inspection techniques as the resultant cracks usually lie under the capacitor terminations but if left, can lead to catastrophic failure. More importantly, mechanical cracks, unless they are severe may not be detected by normal electrical testing of the completed circuit, failure only occurring at some later stage after moisture ingress.

The degree of mechanical stress generated on the printed circuit board is dependent upon several factors including the board material and thickness; the amount of solder and land pattern. The amount of solder applied is important, as an excessive amount reduces the chip's resistance to cracking.

It is Syfer's experience that more than 90% are due to board depanelisation, a process where two or more circuit boards are separated after soldering is complete. Other manufacturing stages that should be reviewed include:

- 1) Attaching rigid components such as connectors, relays, display panels, heat sinks etc.
- 2) Fitting conventional leaded components. Special care must be exercised when rigid terminals, as found on large can electrolytic capacitors, are inserted.
- 3) Storage of boards in such a manner which allows warping.
- 4) Automatic test equipment, particularly the type employing "bed of nails" and support pillars.
- 5) Positioning the circuit board in its enclosure especially where this is a "snap-fit".

Syfer were the first MLCC manufacturer to launch a flexible termination to significantly reduce the instances of mechanical cracking. Flexicap™ termination introduces a certain amount of give into the termination layer absorbing damaging stress. Unlike similar systems, Flexicap™ does not tear under tension, but absorbs the stress, so maintaining the characteristics of the MLCC.

SM Pad Design

Syfer conventional 2-terminal chip capacitors can generally be mounted using pad designs in accordance with IPC-7351, Generic Requirements for Surface Mount Design and Land Pattern Standards, but there are some other factors that have been shown to reduce mechanical stress, such as reducing the pad width to less than the chip width. In addition, the position of the chip on the board should also be considered.

3-Terminal components are not specifically covered by IPC-7351, but recommended pad dimensions are included in the Syfer catalogue / website for these components.

Soldering information

Syfer MLCC's are compatible with all recognised soldering/ mounting methods for chip capacitors. A detailed application note is available on-line at www.syfer.com

Reflow soldering surface mount chip capacitors

Syfer recommend reflow soldering as the preferred method for mounting MLCC's. Syfer MLCC's can be reflow soldered using a reflow profile generally as defined in IPC / JEDEC J-STD-020. Sn plated termination chip capacitors are compatible with both conventional and lead free soldering, with peak temperatures of 260°C to 270°C acceptable.

The heating ramp rate should be such that components see a temperature rise of 1.5°C to 4°C per seconds to maintain temperature uniformity through the MLCC.

The time for which the solder is molten should be maintained at a minimum, so as to prevent solder leaching. Extended times above 230°C can cause problems with oxidation of Sn plating. Use of inert atmosphere can help if this problem is encountered. PdAg terminations can be particularly susceptible to leaching with lead free, tin rich solders and trials are recommended for this combination.

Cooling to ambient temperature should be allowed to occur naturally, particularly if larger chip sizes are being soldered. Natural cooling allows a gradual relaxation of thermal mismatch stresses in the solder joints. Forced cooling should be avoided as this can induce thermal breakage.

Wave soldering Chip and Radial Leaded capacitors

Wave soldering is generally acceptable, but the thermal stresses caused by the wave have been shown to lead to potential problems with larger or thicker chips. Particular care should be taken when soldering SM chips larger than size 1210 and with a thickness greater than 1.0mm for this reason. Maximum permissible wave temperature is 270°C for SM chips and 260°C for Radial Leaded capacitors.

The total immersion time in the solder should be kept to a minimum. It is strongly recommended that Sn/Ni plated terminations are specified for wave soldering applications. PdAg termination is particularly susceptible to leaching when subjected to lead free wave soldering and is not generally recommended for this application.

Total immersion exposure time for Sn/Ni terminations is 30s at a wave temperature of 260°C. Note that for multiple soldering operations, including the rework, the soldering time is cumulative.

The pre-heat ramp should be such that the components see a temperature rise of 1.5°C to 4°C per second as for reflow soldering. This is to maintain temperature uniformity through the MLCC and prevent the formation of thermal gradients within the ceramic. The preheat temperature should be within 120°C maximum (100°C preferred) of the maximum solder temperature to minimise thermal shock.

Cooling to ambient temperature should be allowed to occur naturally, particularly if larger chip sizes are being soldered. Natural cooling allows a gradual relaxation of thermal mismatch stresses in the solder joints. Forced cooling should be avoided as this can induce thermal breakage.

Rework of Chip capacitors

Syfer recommend hot air/ gas as the preferred method for applying heat for rework. Apply even heat surrounding the component to minimise internal thermal gradients. Soldering irons or other techniques that apply direct heat to the chip or surrounding area, should not be used as these can result in micro cracks being generated.

Minimise the rework heat duration and allow components to cool naturally after soldering.

Hand soldering Radial Leaded capacitors

Radial capacitors can be hand soldered into boards using soldering irons, provided care is taken not to touch the body of the capacitor with the iron tip. Soldering should be carried out from the opposite side of the board to the radial to minimise the risk of damage to the capacitor body. Where possible, a heat sink should be used between the solder joint and the body, especially if longer dwell times are required.

Use of silver loaded epoxy adhesives

Chip capacitors can be mounted to circuit boards using silver loaded adhesive provided the termination material of the capacitor is selected to be compatible with the silver loaded adhesive. This is normally PdAg. Standard tin finishes are often not recommended for use with silver loaded epoxies as there can be electrical and mechanical issues with the joint integrity due to material mismatch.

Solder leaching

Leaching is the term for the dissolution of silver into the solder causing a failure of the termination system which causes increased ESR, tan δ and open circuit faults, including ultimately the possibility of the chip becoming detached. Leaching occurs more readily with higher temperature solders and solders with a high tin content. Pb free solders can be very prone to leaching certain termination systems. To prevent leaching, exercise care when choosing solder alloys and minimize both maximum temperature and dwell time with the solder molten.

Plated terminations with nickel or copper anti leaching barrier layers are available in a range of top coat finishes to prevent leaching occurring. These finishes also include Syfer FlexiCap™ for improved stress resistance post soldering.

Multilayer ceramic chip - with nickel barrier termination

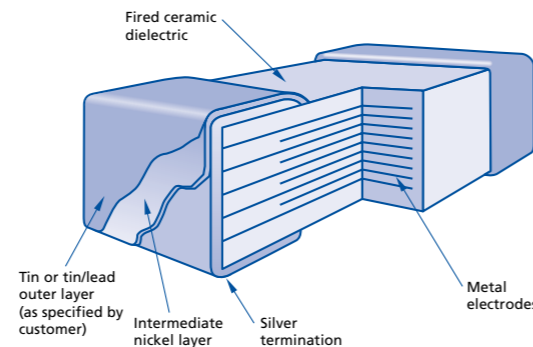

Dimensions

Size	Length (L1) mm inches	Width (W) mm inches	Max. Thickness (T) mm inches	Termination Band L2	
				mm inches	min max
0402	1.0 ± 0.10 0.04 ± 0.006	0.50 ± 0.10 0.02 ± 0.003	0.60 0.031	0.10 0.004	0.40 0.015
0505	1.4 ± 0.38 0.055 ± 0.015	1.4 ± 0.25 0.055 ± 0.010	1.27 0.050	0.13 0.005	0.5 0.020
0603	1.6 ± 0.2 0.063 ± 0.008	0.8 ± 0.2 0.031 ± 0.008	0.8 0.031	0.10 0.004	0.40 0.015
0805	2.0 ± 0.3 0.08 ± 0.012	1.25 ± 0.2 0.05 ± 0.008	1.3 0.051	0.13 0.005	0.75 0.03
1111	2.79 + 0.51 - 0.25 0.110 + 0.020 - 0.010	2.79 ± 0.38 0.110 ± 0.015	2.54 0.100	0.13 0.005	0.63 0.025
1206	3.2 ± 0.3 0.126 ± 0.012	1.6 ± 0.2 0.063 ± 0.008	1.6 0.063	0.25 0.01	0.75 0.03
1210	3.2 ± 0.3 0.126 ± 0.012	2.5 ± 0.3 0.10 ± 0.012	2.0 0.08	0.25 0.01	0.75 0.03
1410	3.6 ± 0.3 0.14 ± 0.012	2.5 ± 0.3 0.10 ± 0.012	2.0 0.08	0.25 0.01	0.75 0.03
1806	4.5 ± 0.35 0.177 ± 0.012	1.6 ± 0.2 0.063 ± 0.008	1.3 0.051	0.25 0.01	0.75 0.03
1808	4.5 ± 0.35 0.18 ± 0.014	2.0 ± 0.3 0.08 ± 0.012	2.0 0.08	0.25 0.01	1.0 0.04
1812	4.5 ± 0.35 0.18 ± 0.014	3.2 ± 0.3 0.126 ± 0.012	3.2 0.126	0.25 0.01	1.0 0.04
1825	4.5 ± 0.35 0.18 ± 0.014	6.30 ± 0.4 0.25 ± 0.016	4.2 0.16	0.25 0.01	1.0 0.04
2211	5.7 ± 0.4 0.225 ± 0.016	2.79 ± 0.3 0.11 ± 0.012	2.5 0.1	0.25 0.01	0.8 0.03
2215	5.7 ± 0.4 0.225 ± 0.016	3.31 ± 0.35 0.15 ± 0.014	2.5 0.1	0.25 0.01	0.8 0.03
2220	5.7 ± 0.4 0.225 ± 0.016	5.0 ± 0.4 0.197 ± 0.016	4.2 0.16	0.25 0.01	1.0 0.04
2225	5.7 ± 0.4 0.225 ± 0.016	6.3 ± 0.4 0.25 ± 0.016	4.2 0.16	0.25 0.01	1.0 0.04
2520	6.30 ± 0.4 0.25 ± 0.016	5.0 ± 0.4 0.197 ± 0.016	4.2 0.16	0.25 0.01	1.0 0.04
3640	9.2 ± 0.5 0.36 ± 0.02	10.16 ± 0.5 0.40 ± 0.02	4.2 0.16	0.5 0.02	1.5 0.06
3820	9.65 ± 0.5 0.37 ± 0.02	5.0 ± 0.4 0.197 ± 0.016	4.2 0.16	0.5 0.02	1.5 0.06
3035	7.62 ± 0.4 0.30 ± 0.016	8.90 ± 0.5 0.35 ± 0.02	4.2 0.16	0.5 0.02	1.5 0.06
4045	10.2 ± 0.5 0.40 ± 0.02	11.5 ± 0.5 0.45 ± 0.02	4.2 0.16	0.5 0.02	1.5 0.06
4545	11.5 ± 0.5 0.45 ± 0.02	11.5 ± 0.5 0.45 ± 0.02	4.2 0.16	0.5 0.02	1.5 0.06
5550	14.0 ± 0.5 0.55 ± 0.02	12.7 ± 0.5 0.50 ± 0.02	4.2 0.16	0.5 0.02	1.5 0.06
5868	14.8 ± 0.5 0.58 ± 0.02	17.3 ± 0.5 0.68 ± 0.02	4.2 0.16	0.5 0.02	1.5 0.06
8040	20.3 ± 0.5 0.80 ± 0.02	10.16 ± 0.5 0.40 ± 0.02	4.2 0.16	0.5 0.02	1.5 0.06
8060	20.3 ± 0.5 0.80 ± 0.02	15.24 ± 0.5 0.60 ± 0.02	4.2 0.16	0.5 0.02	1.5 0.06

Custom chip sizes not included in the table, but larger than 2225, can be considered with minimum tooling charges. Please refer specific requests direct to Syfer.

Max thickness relates to standard components and actual thickness may be considerably less. Thicker parts, or components with reduced maximum thickness, can be considered by request – please refer requests to the Sales Office.

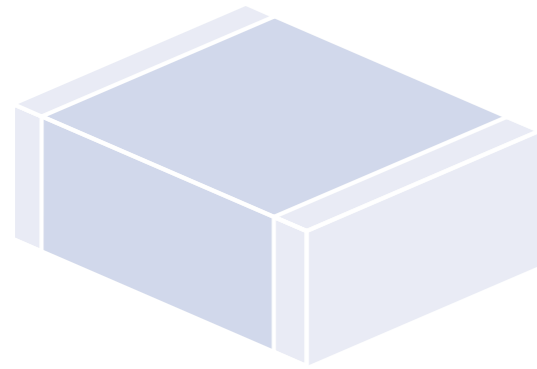

Capacitors and Filters

SM and Leaded



- Modem/Tip and Ring
- Frequency Control/Tuning, Impedance Matching
- High Frequency Snubber
- Decoupling/Smoothing
- AC Noise Removal
- LCD Backlight Inverter
- High Speed Decoupling
- Medical
- Feedthrough Filtering
- Automotive
- Mil/Aero
- Harsh Environments

- High Capacitance
- Safety Certified
- Class 1 Dielectrics
- Class 1 Dielectrics Low DF/ESR
- High Capacitance
- Balanced Line Capacitors
- Safety Certified
- 250Vac range
- Low Capacitance High Voltage, Anti Flashover
- Low Inductance Capacitors
- MRI/Non Magnetic
- Medical Implantable
- Capacitive
- Capacitive/Inductive Pi
- MLCC
- Filtering
- Hi Reliability Capacitors and Filters
- Dipped Radial Leaded Capacitors

- X7R
1812/2220/2225
100nF to 1µF - 250Vdc
- X7R, COG/NPO Y2/X1, Y3/X2, X2
Safety Certified Ranges UL/TÜV
1808/1812/2211/2215/2220
- COG/NPO Range
0402 to 8060
0.47pF to 1µF - 10V to 12kV
- COG/NPO Range
0402 to 8060
0.47pF to 1µF - 10V to 12kV
- X7R/X5R Range
0402 to 8060
100pF to 22µF - 10V to 12kV
- X7R, X2Y IPCs
0603 to 2220
150pF to 1.2µF - 25V to 1kV
- X7R, COG/NPO, Y2/X1, Y3/X2, X2
Safety Certified Ranges UL/TÜV
1808/1812/2211/2215/2220
- X7R, COG/NPO Ranges
Non Safety Capacitors
designed for use at mains voltages
- FB9 LCD Inverter Range
1808/1812
1.5pF to 68pF - 5kV/6kV
- 0505/1111/1825 Ranges
X7R, COG/NPO, High Q
- X7R and COG/NPO, X2Y IPCs
0603 to 2220
10pF to 1.2µF
- X7R, COG/NPO, High Q
0402 to 4040 Copper Barrier Termination
0.1pF to 6.8µF - 16V to 3kV
- High Reliability
Special Testing/burn in MLCC and X2Y
X7R, COG/NPO
- E01/E07/SBSGC/SBSMC
X7R, COG/NPO
0805 to 2220 - 1A to 20A
- SBSP/SBSG/SBSM
X7R, COG/NPO 1206 to 2220
22pF to 470nF - 1A to 10A
- X8R Range
Operational temperature up to 150°C
- AEC-Q200 Ranges
X7R, COG/NPO
- Tandem and Open Mode
FlexiCap™ Capacitors
with extra safe electrode design
- AEC-Q200 X2Y IPCs
X7R and COG/NPO AEC-Q200 E01/E07
Feedthrough Capacitors
- 115Vac 400Hz range
S02A/IECO-CECC/MIL-PRF/Burn in
Hi Rel X2Y IPCs
- X7R, COG/NPO
4.7pF to 15µF - 10V to 10kV

● FlexiCap™ is particularly recommended for these applications where possible.

A range of dc rated multi-layer chip capacitors from 0.47pF to 22µF and case sizes 0603 to 8060 in COG/NPO and X7R dielectrics. Suitable for all general purpose and high reliability applications where package size and reliability are important. All are manufactured using Syfer's unique wet process and incorporate precious metal electrodes.

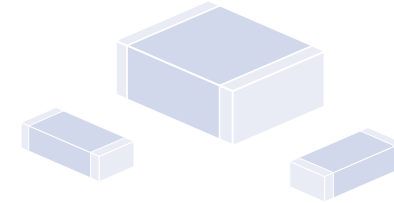
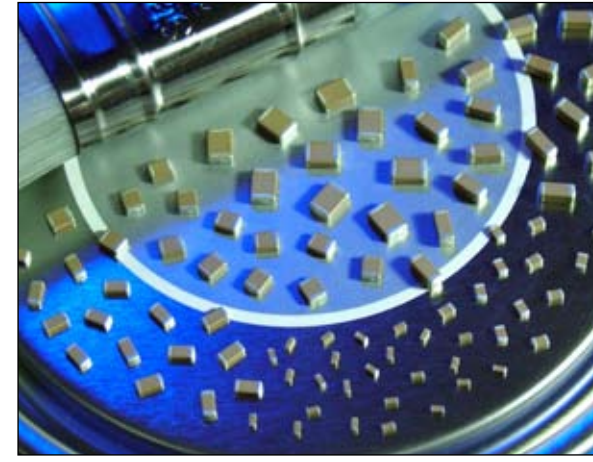

Standard MLCC range dimensions

Size	Length (L1) mm inches	Width (W) mm inches	Max. Thickness (T) mm inches	Termination Band (L2) mm inches	
				min	max
0603	1.6 ± 0.2 0.063 ± 0.008	0.8 ± 0.2 0.031 ± 0.008	0.8 0.031	0.10 0.004	0.40 0.015
0805	2.0 ± 0.3 0.08 ± 0.012	1.25 ± 0.2 0.05 ± 0.008	1.3 0.051	0.13 0.005	0.75 0.03
1206	3.2 ± 0.3 0.126 ± 0.012	1.6 ± 0.2 0.063 ± 0.008	1.6 0.063	0.25 0.01	0.75 0.03
1210	3.2 ± 0.3 0.126 ± 0.012	2.5 ± 0.3 0.1 ± 0.012	2.0 0.08	0.25 0.01	0.75 0.03
1808	4.5 ± 0.35 0.18 ± 0.014	2.0 ± 0.3 0.08 ± 0.012	2.0 0.08	0.25 0.01	1.0 0.04
1812	4.5 ± 0.35 0.18 ± 0.014	3.2 ± 0.3 0.126 ± 0.012	2.5 0.1	0.25 0.01	1.0 0.04
1825	4.5 ± 0.35 0.18 ± 0.014	6.30 ± 0.4 0.25 ± 0.016	2.5 0.1	0.25 0.01	1.0 0.04
2220	5.7 ± 0.4 0.225 ± 0.016	5.0 ± 0.4 0.197 ± 0.016	4.2 0.16	0.25 0.01	1.0 0.04
2225	5.7 ± 0.4 0.225 ± 0.016	6.3 ± 0.4 0.25 ± 0.016	4.2 0.16	0.25 0.01	1.0 0.04
3640	9.2 ± 0.5 0.36 ± 0.02	10.16 ± 0.5 0.4 ± 0.02	2.5 0.1	0.5 0.02	1.5 0.06
5550	14.0 ± 0.5 0.55 ± 0.02	12.7 ± 0.5 0.5 ± 0.02	4.2 0.16	0.5 0.02	1.5 0.06
8060	20.3 ± 0.5 0.8 ± 0.02	15.24 ± 0.5 0.6 ± 0.02	2.5 0.1	0.5 0.02	1.5 0.06

Custom chip sizes not included in the table, but larger than 2225, can be considered with minimum tooling charges. Please refer specific requests direct to Syfer. Max thickness relates to standard components and actual thickness may be considerably less. Thicker parts, or components with reduced maximum thickness, can be considered by request – please refer requests to the factory.

Ordering information - Standard MLCC ranges

1210	Y	100	0103	J	X	T	---
Chip size	Termination	Voltage	Capacitance in picofarads (pF)	Capacitance tolerance	Dielectric	Packaging	Suffix
0603	Y = FlexiCap™ termination base with nickel barrier (100% matte tin plating). H = FlexiCap™ termination base with nickel barrier (100% matte tin plating with min. 10% lead). F = Silver Palladium. RoHS compliant. J = Silver base with nickel barrier (100% matte tin plating). A = Silver base with nickel barrier (Tin/lead plating with min. 10% lead).	010 = 10V	<10pF Insert a P for the decimal point as the first character. eg. P300 = 0.3pF Values in 0.1pF steps ≥ 10pF ≥1.0pF & <10pF Insert a P for the decimal point as the second character. eg. 8P20 = 8.2pF Values are E24 series ≥10pF First digit is 0. Second and third digits are significant figures of capacitance code. Fourth digit is number of zeros eg. 0101 = 100pF Values are E24 series	<10pF B = ±0.1pF C = ±0.25pF D = ±0.5pF	C = COG/NPO (1b) X = X7R (2R1) P = X5R	T = 178mm (7") reel R = 330mm (13") reel B = Bulk pack - tubs	Used for specific customer requirements
0805		016 = 16V					
1206		025 = 25V					
1210		050 = 50V					
1808		063 = 63V					
1812		100 = 100V					
1825		200 = 200V					
2220		250 = 250V					
2225		500 = 500V					
3640		630 = 630V					
5550	1K0 = 1kV						
8060	1K2 = 1.2kV						
	1K5 = 1.5kV						
	2K0 = 2kV						
	2K5 = 2.5kV						
	3K0 = 3kV						
	4K0 = 4kV						
	5K0 = 5kV						
	6K0 = 6kV						

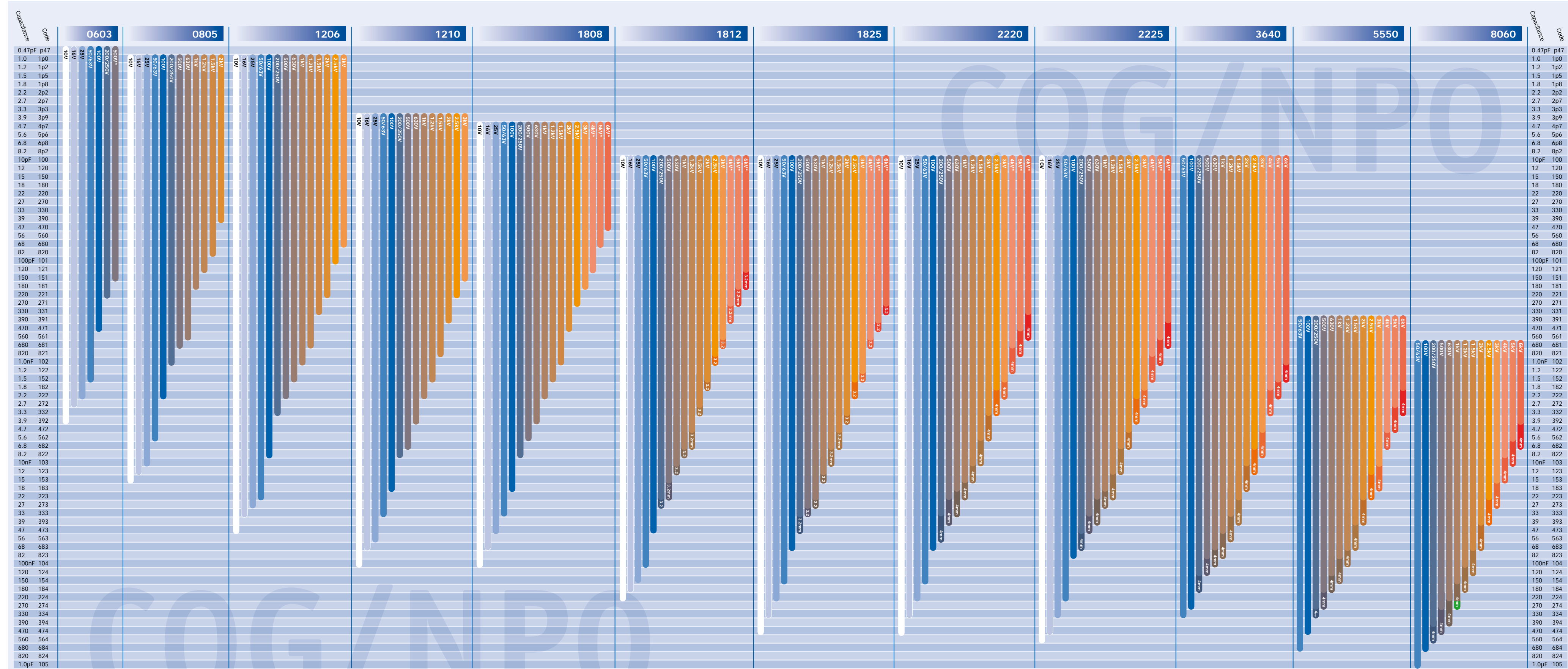

Note:
 1) *These parts may require conformal coating post soldering.
 2) Standard chip thickness = 2.5mm maximum unless specified as 3.2 or 4.0mm..

Note: X7R ranges on reverse

Note: X7R ranges on reverse

Note: X7R ranges on reverse

Note: The highlighted parts are defined as 'dual-use' under export control legislation and as such are subject to export licence restrictions. Please refer to page 9 for further details.

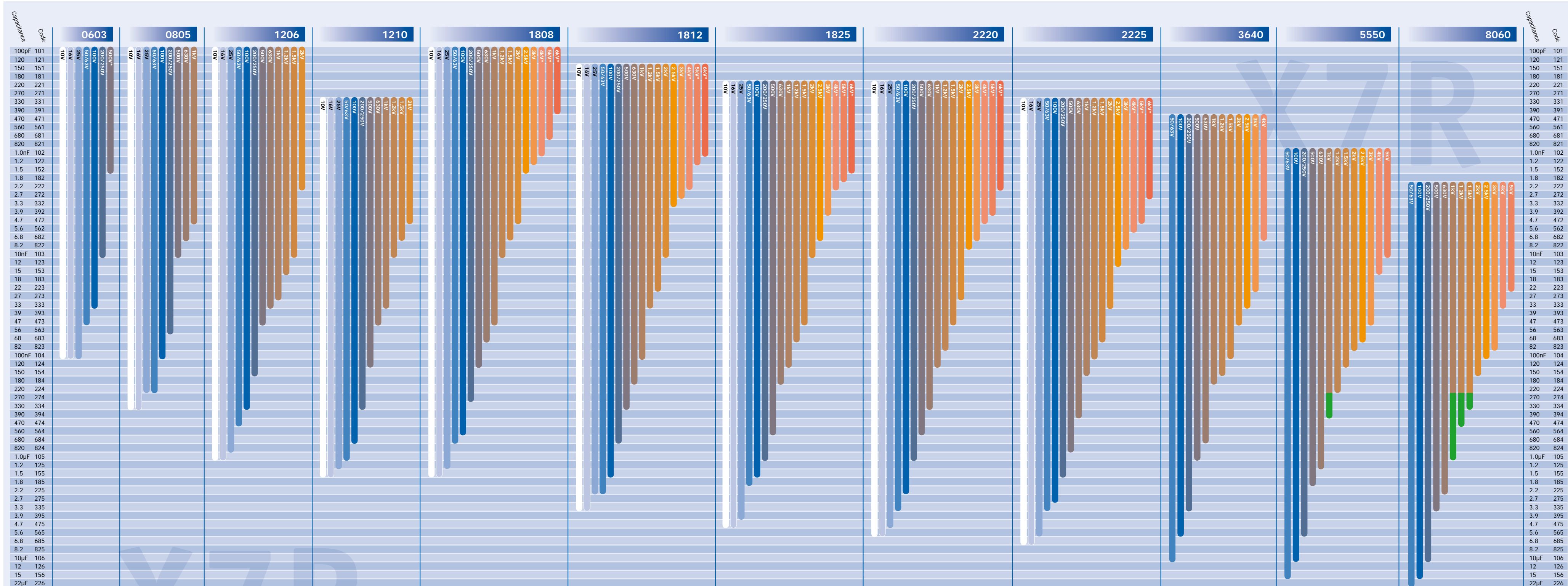

Note: The highlighted parts are defined as 'dual-use' under export control legislation and as such are subject to export licence restrictions. Please refer to page 9 for further details.

Note:
1) *These parts may require conformal coating post soldering.

Note: COG/NPO ranges on reverse

Note: COG/NPO ranges on reverse

Note: COG/NPO ranges on reverse

The X8R dielectric will operate from -55°C to +150°C, with a maximum capacitance change ±15% (without applied voltage). The devices are available in sizes 0805 to 2225, with voltage ranges from 25V to 250V and capacitance values from 1nF to 1.8µF. The capacitors have been developed by Syfer to meet demand from various applications in the automotive and industrial markets and in other electronic equipment exposed to high temperatures. The increased use of electronics in automotive "under the hood" applications has created demand for this product range. The X8R range incorporates a specially formulated termination with a nickel barrier finish that has been designed to enhance the mechanical performance of these SMD chip capacitors in harsh environments typically present in automotive applications.

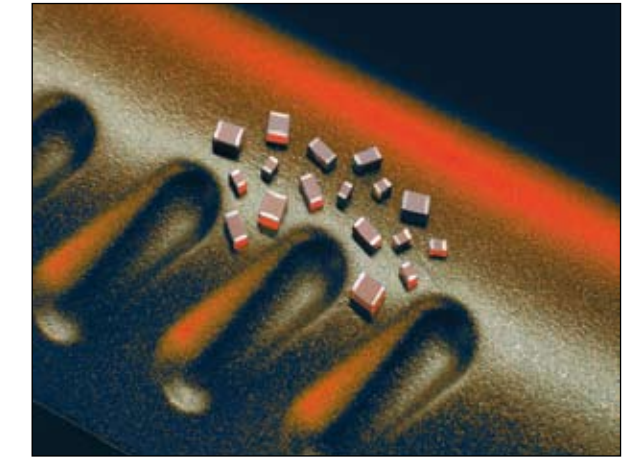

Capacitance Range
1.0nF to 1.8µF

Temperature Coefficient of Capacitance (TCC)
± 15% from -55°C to +150°C

Dissipation Factor (DF)
≤ 0.025

Insulation Resistance (IR)
100G Ω or 1000secs (whichever is the less).

Dielectric Withstand Voltage (DWV)
2.5 x rated voltage for 5±1 seconds,
50mA charging current maximum.

Ageing Rate
1% per decade (typical)

Max cap. values according to the rated d.c. voltage

	0805	1206	1210	1812	2220	2225
Min Cap. value	1.0nF	2.2nF	4.7nF	6.8nF	10nF	10nF
Max. cap value according to the rated dc voltage	25V	56nF	180nF	330nF	680nF	1.5µF
	50V	33nF	120nF	220nF	470nF	1.0µF
	100V	15nF	56nF	120nF	220nF	470nF
	200/250V	10nF	33nF	68nF	120nF	220nF

Ordering information - X8R High Temperature capacitors

1206	Y	100	0473	K	N	T
Chip size	Termination	Voltage d.c.	Capacitance in picofarads (pF)	Capacitance tolerance	Dielectric codes	Packaging
0805 1206 1210 1812 2220 2225	Y = Nickel barrier with polymeric silver termination	025 = 25V 050 = 50V 100 = 100V 200 = 200V 250 = 250V	First digit is 0. Second and third digits are significant figures of capacitance code. The fourth digit is number of zeros following. Example: 0473 = 47000pF = 47nF	J = ±5% K = ±10% M = ±20%	N = X8R	T = 178mm (7") reel R = 330mm (13") reel B = Bulk pack - tubs

TCC/VCC range

X7R capacitors are available from Syfer with a defined capacitance variation under applied dc voltage, across the full operating temperature range. Whilst the capacitance of COG/NPO chips does not vary with applied voltage, standard X7R capacitors exhibit capacitance fluctuation, but with no specified limit. For applications where a limit is required, Syfer is able to offer either a "B" code dielectric (conforms to MIL "BX" dielectric and IECQ-CECC "2X1") or "R" code dielectric (conforms to MIL "BZ" dielectric and IECQ-CECC "2C1").

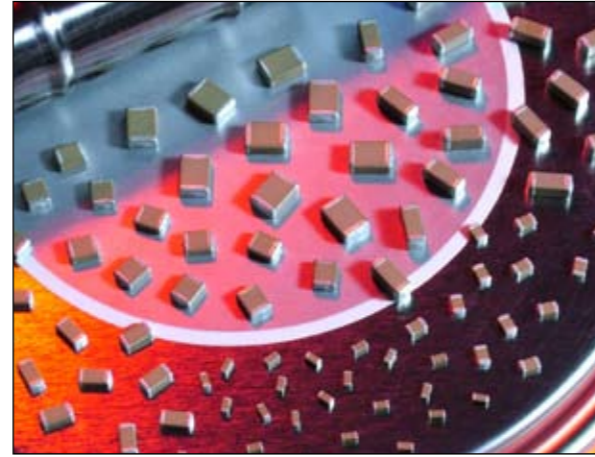

2C1 (BZ) capacitor range

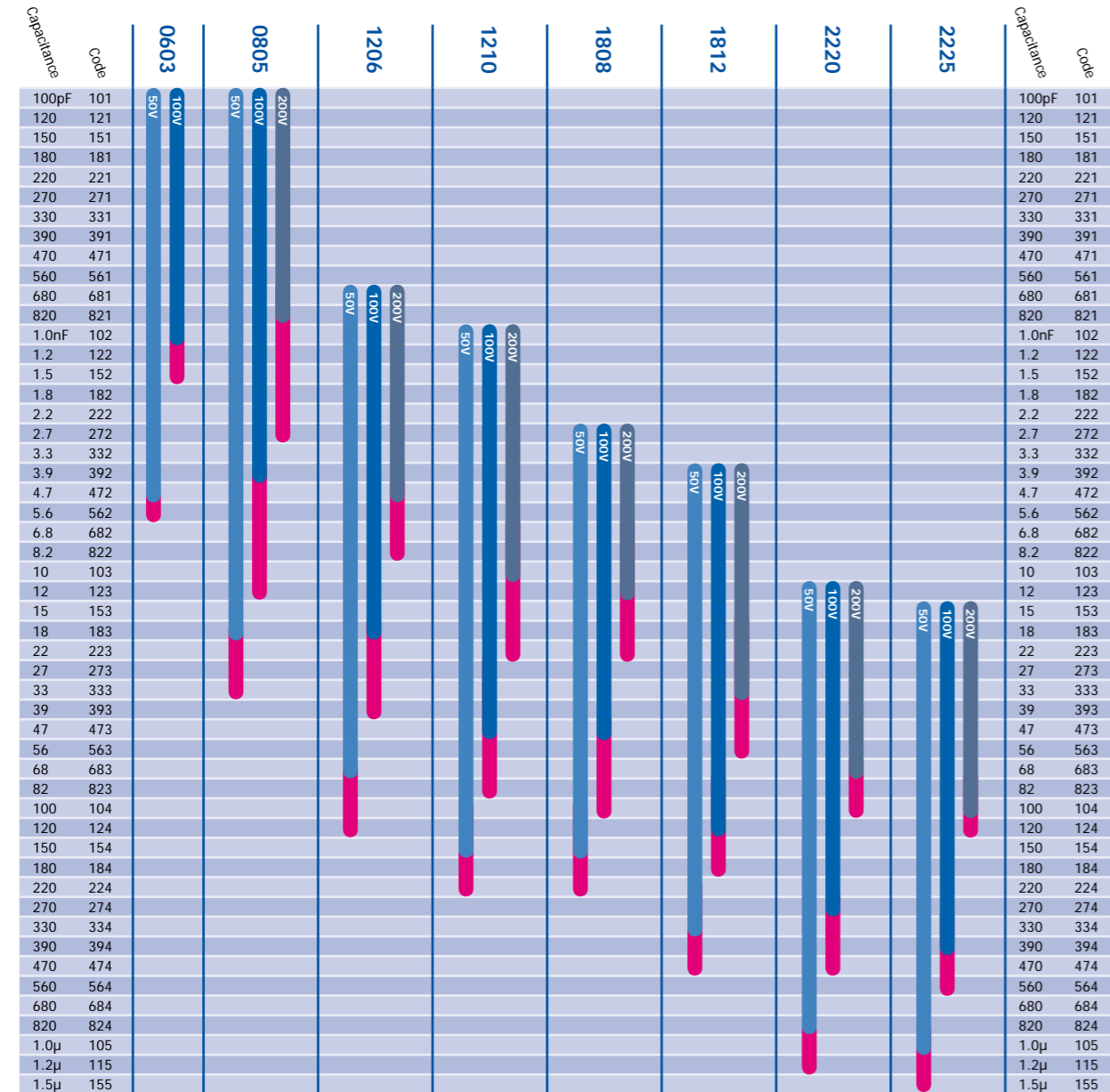

● = FlexiCap™ termination only. Other values available in J, Y and F terminations.

		X7R		
Dielectric characteristics		Stable		
	IECQ-CECC	2C1	2R1	2X1
	EIA	-	X7R	-
	MIL	BZ	-	BX
Rated temperature range		-55°C to +125°C		
Maximum capacitance charge over temperature range		No DC voltage applied		
		±20%	±15%	±15%
		Rated DC voltage applied		
		+20-30%	-	+15-25%
Syfer dielectric ordering code		R	X	B

For part numbering, the "X" denoting the X7R dielectric code needs to be replaced by either "B" or "R". Please contact the Sales Office for full range information.

2X1 (BX) capacitor range

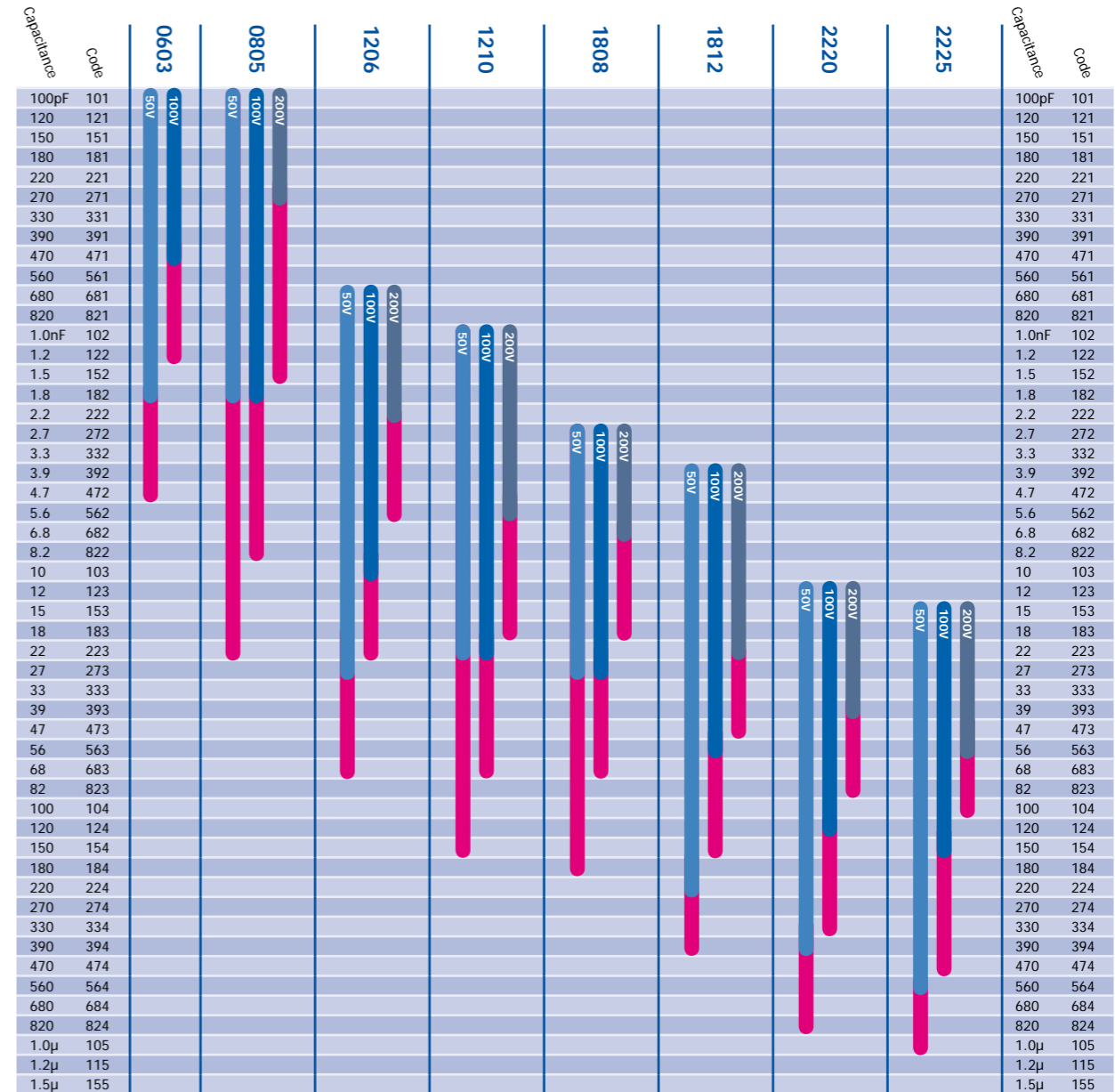

● = FlexiCap™ termination only. Other values available in J, Y and F terminations.

The Syfer MS range offers a very stable, High Q material system that provides excellent, low loss performance in systems below 3GHz. Available in 0402 to 3640 case sizes with various termination options including FlexiCap™, this range of high frequency capacitors is suitable for many applications where economical, high performance is required.

Operating Temperature
-55°C to +125°C

Temperature Coefficient (Typical)
0 ± 30 ppm/°C

Insulation resistance at +25°C
>100GΩ

Insulation resistance at +125°C
>10GΩ



High Q capacitors - capacitance values

Chip Size	0402	0603	0505	0805	1206	1111	1210	1812	2220	2225	3640
Min Cap	0.1pF	0.1pF	0.2pF	0.2pF	0.5pF	0.3pF	0.3pF	1.0pF	2.0pF	2.0pF	4.0pF
50V 63V	33pF	220pF	330pF	680pF	2.2nF						
100V	22pF	150pF	220pF	470pF	1.5nF	3.3nF	3.3nF	6.8nF	15nF	18nF	
150V	18pF	120pF	180pF	390pF	1.2nF	2.7nF	2.7nF	4.7nF	12nF	15nF	
200V 250V	15pF	100pF	150pF	330pF	1.0nF	2.2nF	2.2nF	3.9nF	10nF	10nF	
300V		56pF	100pF	220pF	680pF	1.5nF	1.5nF	3.3nF	6.8nF	8.2nF	
500V				100pF	330pF	820pF	820pF	2.2nF	4.7nF	5.6nF	15nF
630V					150pF	390pF	390pF	1.0nF	2.2nF	3.3nF	6.8nF
1000V					82pF	220pF	220pF	680pF	1.5nF	2.2nF	4.7nF
2000V					18pF	68pF	68pF	150pF	470pF	560pF	1.5nF
3000V								68pF	150pF	220pF	470pF
Tape quantities	7" reel 5000	7" reel 4000	7" reel 2500	7" reel 3000	7" reel 2500	7" reel 1000	7" reel 2000	7" reel 500 13" reel 2000	7" reel 500 13" reel 2000	7" reel 500 13" reel 2000	7" reel n/a 13" reel n/a

Below 1pF capacitance values are available in 0.1pF steps.
Above 1pF capacitance values are available in E24 series values.
Other values and taping quantities may be available on request, consult the sales office for details.

Ordering information - High Q capacitors - MS range

0505	J	250	4P70	B	Q	T
Chip size	Termination	Voltage	Capacitance in picofarads (pF)	Capacitance tolerance	Dielectric	Packaging
0402 0603 0505 0805 1206 1111 1210 1812 2220 2225 3640	Y = FlexiCap™ termination base with nickel barrier (100% matte tin plating). RoHS compliant. Lead free. H = FlexiCap™ termination base with nickel barrier (Tin/lead plating with min. 10% lead). J = Silver base with nickel barrier (100% matte tin plating). RoHS compliant. Lead free. A = Silver base with nickel barrier (Tin/lead plating with min. 10% lead).	050 = 50V 063 = 63V 100 = 100V 150 = 150V 200 = 200V 250 = 250V 300 = 300V 500 = 500V 630 = 630V 1K0 = 1000V 2K0 = 2000V 3K0 = 3000V	<1.0pF Insert a P for the decimal point as the first character. eg. P300 = 0.3pF Values in 0.1pF steps ≥1.0pF & <10pF Insert a P for the decimal point as the second character. eg. 8P20 = 8.2pF Values are E24 series ≥10pF First digit is 0. Second and third digits are significant figures of capacitance code. Fourth digit is number of zeros eg. 0101 = 100pF Values are E24 series	<4.7pF H = ±0.05pF B = ±0.1pF C = ±0.25pF D = ±0.5pF <10pF B = ±0.1pF C = ±0.25pF D = ±0.5pF ≥10pF F = ±1% G = ±2% J = ±5% K = ±10%	Q = High Q Ceramic	T = 178mm (7") reel R = 330mm (13") reel B = Bulk pack - tubs

Typical performance data - 0805 chip size*

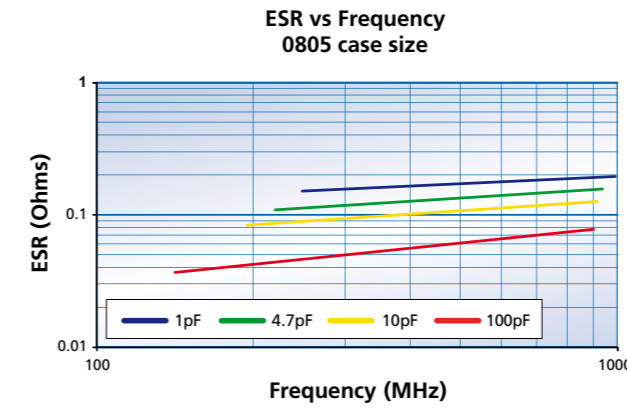

Typical performance data - 1111 chip size*

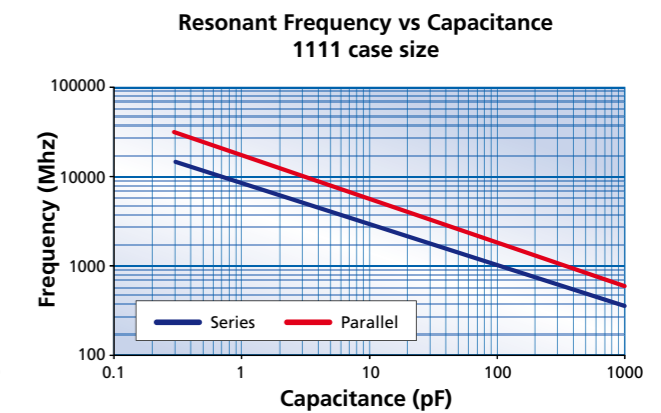
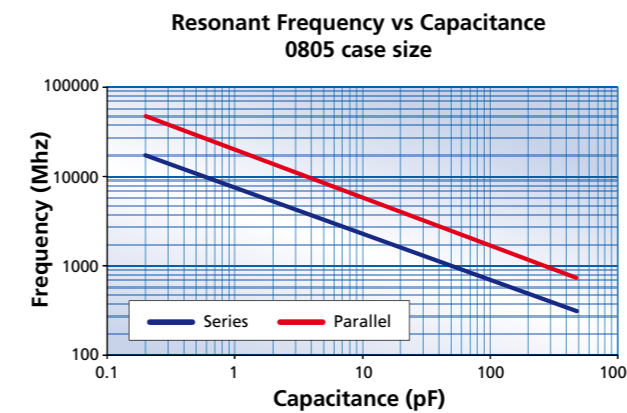
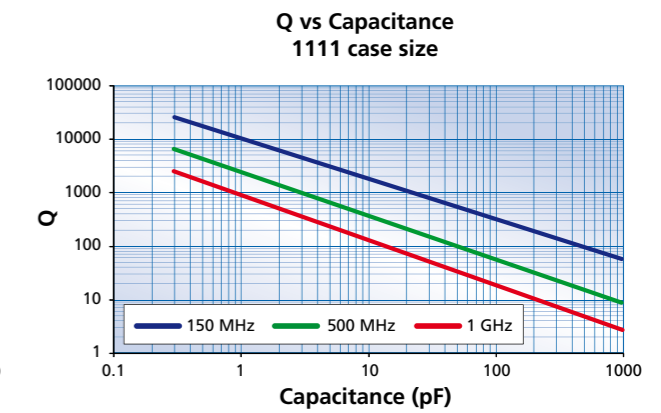
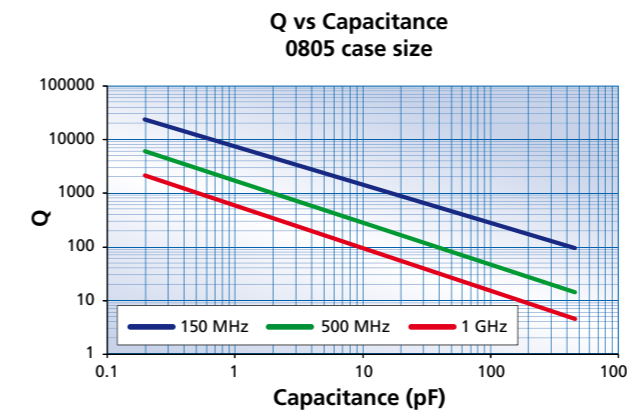
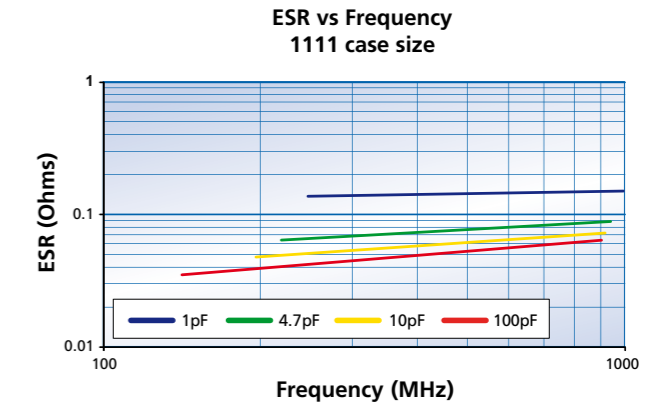

* Refer to the Sales Office for other chip size electrical data.

Multilayer ceramic capacitors with silver/palladium (Ag/Pd) terminations have often been used in medical applications where non-magnetic components are required, for example in MRI equipment. The use of conventional nickel barrier terminations is not suitable due to nickel exhibiting magnetic properties.

However, RoHS requirements have dictated the use of lead-free solders, and the composition of these solders has resulted in an increase in soldering temperatures. This has caused solder leaching problems for the Ag/Pd termination, and meant alternative terminations have had to be found.

As copper is non-magnetic, one solution is to use a copper barrier instead of a nickel barrier, with a tin finish on top, and this is the solution Syfer has developed.

This copper barrier termination is offered with selected non-magnetic COG/NPO, High Q and X7R dielectrics, providing a fully non-magnetic component.

To meet high temperature 260°C soldering reflow



profiles as detailed in J-STD-020, COG/NPO dielectrics are supplied with sintered termination and X7R dielectrics are supplied with Syfer's award winning FlexiCap™ termination.

COG/NPO & High Q - maximum capacitance values

Chip Size	0402	0603	0505	0805	1206	1111 1210	1808	1812	2220	2225
Min Cap	0.1pF	0.1pF	0.2pF	0.2pF	0.5pF	0.3pF	1.0pF	1.0pF	2.0pF	2.0pF
Min Cap Tolerance	±0.05pF (<4.7pF), 0.1pF (≥4.7pF & <10pF) and ±1% (≥10pF)									
50V 63V	22pF	100pF	220pF	470pF	1.5nF	-	-	-	-	-
100V	15pF	68pF	150pF	330pF	1.0nF	2.2nF	2.2nF	4.7nF	10nF	15nF
150V	10pF	47pF	100pF	220pF	680pF	1.5nF	1.5nF	3.3nF	6.8nF	10nF
200V 250V	6.8pF	33pF	56pF	150pF	470pF	1.0nF	1.0nF	2.2nF	4.7nF	6.8nF
300V	-	27pF	47pF	120pF	390pF	820pF	820pF	1.8nF	3.9nF	5.6nF
500V	-	-	-	68pF	270pF	680pF	680pF	1.5nF	3.3nF	4.7nF
630V	-	-	-	-	150pF	390pF	390pF	1.0nF	2.2nF	3.3nF
1000V	-	-	-	-	82pF	220pF	220pF	680pF	1.5nF	2.2nF
2000V	-	-	-	-	18pF	68pF	68pF	150pF	470pF	560pF
3000V	-	-	-	-	-	-	-	68pF	150pF	220pF

X7R - maximum capacitance values

Chip Size	0402	0603	0805	1206	1210	1808	1812	2220	2225
Min Cap	47pF	100pF	330pF	680pF	1.5nF	2.2nF	3.3nF	6.8nF	10nF
Min Cap Tolerance	±5%								
16V	10nF	100nF	330nF	1.0µF	1.5µF	1.5µF	3.3µF	5.6µF	6.8µF
25V	6.8nF	68nF	220nF	820nF	1.2µF	1.2µF	2.2µF	4.7µF	5.6µF
50V 63V	4.7nF	47nF	150nF	470nF	1.0µF	680nF	1.5µF	3.3µF	3.3µF
100V	1.5nF	10nF	47nF	150nF	470nF	330nF	1.0µF	1.5µF	1.5µF
200V 250V	680pF	5.6nF	27nF	100nF	220nF	180nF	470nF	1.0µF	1.0µF
500V	-	1.5nF	8.2nF	33nF	100nF	100nF	270nF	560nF	680nF
630V	-	-	4.7nF	10nF	27nF	33nF	150nF	330nF	390nF
1000V	-	-	3.3nF	4.7nF	15nF	18nF	56nF	120nF	150nF
1200V	-	-	-	3.3nF	10nF	10nF	33nF	82nF	100nF
1500V	-	-	-	2.7nF	6.8nF	6.8nF	22nF	47nF	68nF
2000V	-	-	-	2.2nF	4.7nF	4.7nF	10nF	27nF	33nF

Reeled Quantities

7" Reel	5000	4000	2500	3000	2500	1000	2000	2000	500	500	500
13" Reel	13" reel quantities available on request							8000	2000	2000	2000

Note: Other capacitance values may become available, please contact our Sales Office if you need values other than those shown in the above tables. For dimensions and soldering information, please go to our website (www.syfer.com) or see our MLC Catalogue.

Ordering information - Copper Barrier capacitors

1210	3	100	0103	J	X	T	---
Chip size	Termination	Voltage	Capacitance in picofarads (pF)	Capacitance tolerance	Dielectric codes	Packaging	Suffix
0402 0603 0505 0805 1206 1111 1210 1808 1812 2220 2225	<p>2 = Sintered silver base with copper barrier (100% matte tin plating). RoHS compliant. (available on COG/NPO & High Q only).</p> <p>3 = FlexiCap™ base with copper barrier (100% matte tin plating). RoHS compliant.</p> <p>4 = Sintered silver base with copper barrier (tin/lead plating). Non RoHS compliant. (available on COG/NPO & High Q only).</p> <p>5 = FlexiCap™ base with copper barrier (tin/lead plating). Non RoHS compliant.</p>	<p>016 = 16V 025 = 25V 050 = 50V 063 = 63V 100 = 100V 150 = 150V 200 = 200V 250 = 250V 500 = 500V 630 = 630V 1K0 = 1000V 1K2 = 1200V 1K5 = 1500V 2K0 = 2000V 3K0 = 3000V</p>	<p><10pF Insert a P for the decimal point, eg P300 = 0.3pF, 8P20 = 8.2pF.</p> <p>≥10pF 1st digit is 0. 2nd and 3rd digits are significant figures of capacitance code. The 4th digit is number of 0's following eg. 0103 = 10000pF</p> <p>Values <1pF in 0.1pF steps, above this values are E24 series</p>	<p><4.7pF H = ±0.05pF B = ±0.1pF C = ±0.25pF D = ±0.5pF ≥4.7pF & <10pF B = ±0.1pF C = ±0.25pF D = ±0.5pF ≥10pF F = ±1% G = ±2% J = ±5% K = ±10%</p>	<p>C = COG/NPO (1B) X = X7R (2R1) Q = High Q</p>	<p>T = 178mm (7") reel R = 330mm (13") reel B = Bulk pack - tubs</p>	Used for specific customer requirements



Open Mode capacitors have been designed specifically for use in applications where mechanical cracking is a severe problem and short circuits due to cracking are unacceptable.

Open Mode capacitors use inset electrode margins, which prevent any mechanical cracks which may form during board assembly from connecting to the internal electrodes.

When combined with Syfer's FlexiCap™ termination, Syfer Open Mode capacitors provide a robust component with the assurance that if a part becomes cracked, the crack will be unlikely to result in short circuit failure.



Open Mode capacitor -

Open Mode max capacitance (X7R only)

	0603	0805	1206	1210	1812	2220	2225
16V	39nF	150nF	470nF	680nF	1.5µF	3.3µF	4.7µF
25V	33nF	120nF	330nF	560nF	1.2µF	2.2µF	3.9µF
50/63V	22nF	100nF	220nF	470nF	1.0µF	1.5µF	2.7µF
100V	6.8nF	27nF	100nF	220nF	680nF	1.0µF	1.8µF
200/250V	2.7nF	15nF	68nF	100nF	330nF	680nF	1.0µF

Qualification included cracking the components by severe bend tests. Following the bend tests cracked components were subjected to endurance / humidity tests, with no failures evident due to short circuits. Note: Depending on the severity of the crack, capacitance loss was between 0% and 70%.

Tandem Capacitors have been designed as a fail safe range using a series section internal design, for use in any application where short circuits would be unacceptable.

When combined with Syfer's FlexiCap™ termination, Syfer Tandem capacitors provide an ultra robust and reliable component, for use in the most demanding applications.

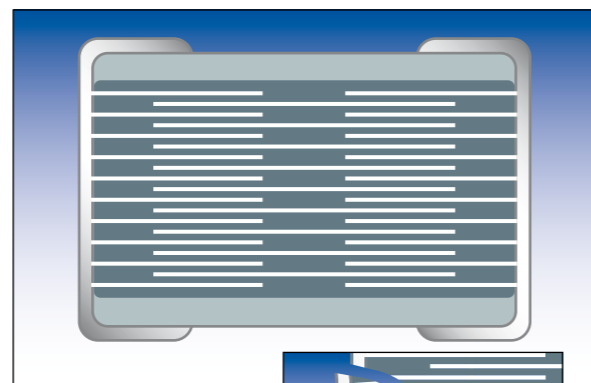

Tandem capacitor -

Tandem max capacitance (X7R only)

	0603	0805	1206	1210	1812	2220	2225
16V	12nF	47nF	150nF	270nF	560nF	1.2µF	1.5µF
25V	10nF	39nF	120nF	220nF	470nF	1.0µF	1.2µF
50/63V	6.8nF	33nF	100nF	180nF	390nF	680nF	1.0µF
100V	2.2nF	10nF	47nF	82nF	220nF	470nF	680nF
200/250V	1.0nF	4.7nF	22nF	47nF	100nF	220nF	330nF

Qualification included cracking the components by severe bend tests. Following the bend tests cracked components were subjected to endurance / humidity tests, with no failures evident due to short circuits. Note: Depending on the severity of the crack, capacitance loss was between 0% and 50%.

Ordering information - Open Mode and Tandem capacitors

1206	Y	050	0224	K	X	T	---
Chip size	Termination	Voltage	Capacitance in picofarads (pF)	Capacitance tolerance	Dielectric codes	Packaging	Suffix
0603 0805 1206 1210 1812 2220 2225	Y = Polymer Termination FlexiCap™	016 = 16V 025 = 25V 050 = 50V 063 = 63V 100 = 100V 200 = 200V 250 = 250V	First digit is 0. Second and third digits are significant figures of capacitance code. The fourth digit is number of zeros following. Example: 0224 = 220000pF	K = ±10%	X = X7R E = X7R (AEC-Q200 product)	T = 178mm (7") reel R = 330mm (13") reel	M01 = Syfer Open Mode capacitor T01 = Syfer Tandem capacitor

A range of specialist high reliability MLCC's for use in critical or high reliability environments. All fully tested / approved and available with a range of suitable termination options, including tin/lead plating and Syfer Flexicap™.

Ranges include :-

1. Range tested and approved in accordance with IECQ-CECC QC32100.
2. Range qualified to the requirements of AEC-Q200.
3. Range qualified to the requirements of ESCC 3009 European Space Specification.



IECQ-CECC - maximum capacitance values

		0603	0805	1206	1210	1808	1812	2220	2225
16V	COG/NPO	1.5nF	6.8nF	22nF	33nF	33nF	100nF	150nF	220nF
	X7R	100nF	330nF	1.0µF	1.5µF	1.5µF	3.3µF	5.6µF	6.8µF
25V	COG/NPO	1.0nF	4.7nF	15nF	22nF	27nF	68nF	100nF	150nF
	X7R	56nF	220nF	820nF	1.2µF	1.2µF	2.2µF	4.7µF	5.6µF
50/63V	COG/NPO	470pF	2.7nF	10nF	18nF	18nF	33nF	68nF	100nF
	X7R	47nF	220nF	470nF	1.0µF	680nF	1.5µF	2.2µF	3.3µF
100V	COG/NPO	330pF	1.8nF	6.8nF	12nF	12nF	27nF	47nF	68nF
	X7R	10nF	47nF	150nF	470nF	330nF	1.0µF	1.5µF	1.5µF
200V	COG/NPO	100pF	680pF	2.2nF	4.7nF	4.7nF	12nF	22nF	27nF
	X7R	5.6nF	27nF	100nF	220nF	180nF	470nF	1.0µF	1.0µF
500V	COG/NPO	n/a	330pF	1.5nF	3.3nF	3.3nF	10nF	15nF	22nF
	X7R	n/a	8.2nF	33nF	100nF	100nF	270nF	560nF	820nF
1kV	COG/NPO	n/a	n/a	470pF	1.0nF	1.2nF	3.3nF	8.2nF	10nF
	X7R	n/a	n/a	4.7nF	15nF	18nF	56nF	120nF	150nF

Ordering information - IECQ-CECC ranges

1210	Y	100	0103	J	D	T	---
Chip size	Termination	Voltage	Capacitance in picofarads (pF)	Capacitance tolerance	Dielectric Release codes	Packaging	Suffix code
	Y = FlexiCap™ termination base with Ni barrier (100% matte tin plating). RoHS compliant. H = FlexiCap™ termination base with Ni barrier (Tin/lead plating with min. 10% lead). F = Silver Palladium. RoHS compliant. J = Silver base with nickel barrier (100% matte tin plating). RoHS compliant. A = Silver base with nickel barrier (Tin/lead plating with min. 10% lead).	016 = 16V 025 = 25V 050 = 50V 063 = 63V 100 = 100V 200 = 200V 250 = 250V 500 = 500V 630 = 630V 1K0 = 1kV	First digit is 0. Second and third digits are significant figures of capacitance code. The fourth digit is number of zeros following Example: 0103 = 10nF	<10pF B = ±0.1pF C = ±0.25pF D = ±0.5pF ≥ 10pF F = ±1% G = ±2% J = ±5% K = ±10% M = ±20%	D = X7R (2R1) with IECQ-CECC release F = COG/NPO (1B/NPO) with IECQ-CECC release B = 2X1/ BX released in accordance with IECQ-CECC R = 2C1/ BZ released in accordance with IECQ-CECC	T = 178mm (7") reel R = 330mm (13") reel B = Bulk pack - tubs	Used for specific customer requirements

AEC-Q200 ranges

Maximum capacitance values

		0603	0805	1206	1210	1812
50/63V	COG/NPO	470pF	2.7nF	10nF	18nF	39nF
	X7R	33nF	150nF	330nF	680nF	1.5µF
100V	COG/NPO	330pF	1.8nF	6.8nF	12nF	27nF
	X7R	10nF	47nF	150nF	470nF	1µF
200V	COG/NPO	100pF	680pF	2.2nF	4.7nF	12nF
	X7R	5.6nF	27nF	100nF	220nF	470nF
500V	COG/NPO	n/a	330pF	1.5nF	3.9nF	10nF
	X7R	n/a	8.2nF	33nF	100nF	270nF
630V	COG/NPO	n/a	n/a	1.0nF	1.8nF	5.6nF
	X7R	n/a	n/a	10nF	27nF	150nF
1kV	COG/NPO	n/a	n/a	470pF	1nF	3.3nF
	X7R	n/a	n/a	4.7nF	15nF	56nF

Ordering information - AEC-Q200

1210	Y	100	0103	J	E	T	---
Chip size	Termination	Voltage	Capacitance in picofarads (pF)	Capacitance tolerance	Dielectric Release codes	Packaging	Suffix code
	<p>Y = FlexiCap™ termination base with Ni barrier (100% matte tin plating). RoHS compliant.</p> <p>H = FlexiCap™ termination base with Ni barrier (Tin/lead plating with min. 10% lead).</p> <p>F = Silver Palladium. RoHS compliant.</p> <p>J = Silver base with nickel barrier (100% matte tin plating). RoHS compliant.</p> <p>A = Silver base with nickel barrier (Tin/lead plating with min. 10% lead).</p>	<p>016 = 16V</p> <p>025 = 25V</p> <p>050 = 50V</p> <p>063 = 63V</p> <p>100 = 100V</p> <p>200 = 200V</p> <p>250 = 250V</p> <p>500 = 500V</p> <p>630 = 630V</p> <p>1K0 = 1kV</p>	<p>First digit is 0.</p> <p>Second and third digits are significant figures of capacitance code.</p> <p>The fourth digit is number of zeros following</p> <p>Example: 0103 = 10nF</p>	<p><10pF</p> <p>B = ±0.1pF</p> <p>C = ±0.25pF</p> <p>D = ±0.5pF</p> <p>≥ 10pF</p> <p>F = ±1%</p> <p>G = ±2%</p> <p>J = ±5%</p> <p>K = ±10%</p> <p>M = ±20%</p>	<p>E = X7R (2R1) AEC-Q200</p> <p>A = COG/NPO (1B/NPO) AEC-Q200</p>	<p>T = 178mm (7") reel</p> <p>R = 330mm (13") reel</p> <p>B = Bulk pack - tubs</p>	Used for specific customer requirements

3 Terminal EMI Components (E01) - AEC-Q200 ranges

Maximum capacitance values

		0805	1206	1806
50V	COG/NPO	820pF	1.0nF	2.2nF
	X7R	47nF	100nF	200nF
100V	COG/NPO	560pF	1.0nF	2.2nF
	X7R	15nF	15nF	68nF

Note: For some lower capacitance parts, higher voltage rated parts may be supplied. Refer to page 36.

X2Y Integrated Passive Components (E03) - AEC-Q200 ranges

Maximum capacitance values

		0805	1206	1410	1812
50V	COG/NPO	470pF	1.5nF	5.6nF	10nF
	X7R	33nF	150nF	330nF	560nF
100V	COG/NPO	330pF	1.0nF	3.9nF	6.8nF
	X7R	15nF	47nF	150nF	330nF

Note: For some lower capacitance parts, higher voltage rated parts may be supplied. Refer to page 38.

S02A Space ranges

Maximum capacitance values

		0603	0805	1206	1210	1812	2220	2225
16V	COG/NPO	390pF - 1.5nF	1pF - 6.8nF	1pF - 22nF	10pF - 33nF	220pF - 100nF	470pF - 150nF	560pF - 220nF
	X7R	330pF - 100nF	100pF - 330nF	680pF - 1.0µF	1.0nF - 1.5µF	3.9nF - 3.3µF	10nF - 5.6µF	18nF - 6.8µF
25V	COG/NPO	390pF - 1.0nF	1pF - 4.7nF	1pF - 15nF	10pF - 22nF	220pF - 68nF	470pF - 100nF	560pF - 150nF
	X7R	330pF - 56nF	100pF - 220nF	680pF - 820nF	1.0nF - 1.2µF	3.9nF - 2.2µF	10nF - 4.7µF	18nF - 5.6µF
50/63V	COG/NPO	0.5pF - 470pF	1pF - 2.7nF	1pF - 10nF	10pF - 18nF	220pF - 39nF	470pF - 68nF	560pF - 100nF
	X7R	330pF - 47nF	100pF - 220nF	680pF - 470nF	1.0nF - 1.0µF	3.9nF - 2.2µF	10nF - 3.3µF	18nF - 3.3µF
100V	COG/NPO	1pF - 330pF	1pF - 1.8nF	1pF - 6.8nF	10pF - 12nF	220pF - 27nF	470pF - 47nF	560pF - 68nF
	X7R	100pF - 10nF	100pF - 47nF	100pF - 150nF	1.0nF - 470nF	3.9nF - 1.0µF	10nF - 1.5µF	18nF - 1.5µF
200V	COG/NPO	1pF - 100pF	1pF - 680pF	1pF - 2.2nF	10pF - 4.7nF	220pF - 12nF	470pF - 22nF	560pF - 27nF
	X7R	100pF - 5.6nF	100pF - 27nF	100pF - 100nF	1.0nF - 220nF	3.9nF - 470nF	10nF - 1.0µF	18nF - 1.0µF
500V	COG/NPO	-	1pF - 270pF	1pF - 1.2nF	10pF - 2.7nF	180pF - 6.8nF	390pF - 15nF	4.7nF - 18nF
	X7R	-	10pF - 8.2nF	180pF - 33nF	390pF - 100nF	390pF - 270nF	1nF - 560nF	15nF - 820nF

Note: In accordance with ESCC 3009.

Ordering information - S02A Space ranges product code construction

1210	A	100	0103	J	X	T	---
Chip size	Termination ⁽¹⁾	Voltage	Capacitance in picofarads (pF)	Capacitance tolerance	Dielectric Rel Release codes	Packaging	Suffix code
	<p>A = Silver base with nickel barrier (Tin/lead plating with min. 10% lead).</p> <p>F = Silver Palladium. RoHS compliant.</p> <p>H = FlexiCap™ termination base with Ni barrier (Tin/lead plating with min. 10% lead).</p>	<p>016 = 16V</p> <p>025 = 25V</p> <p>050 = 50V</p> <p>063 = 63V</p> <p>100 = 100V</p> <p>200 = 200V</p> <p>500 = 500V</p>	<p>First digit is 0.</p> <p>Second and third digits are significant figures of capacitance code.</p> <p>The fourth digit is number of zeros following</p> <p>Example: 0103 = 10nF</p>	<p><10pF</p> <p>B = ±0.1pF</p> <p>C = ±0.25pF</p> <p>D = ±0.5pF</p> <p>≥ 10pF</p> <p>F = ±1%</p> <p>G = ±2%</p> <p>J = ±5%</p> <p>K = ±10%</p> <p>M = ±20%</p>	<p>C = COG/NPO (1B)</p> <p>X = X7R (2R1)</p>	<p>T = 178mm (7") reel</p> <p>R = 330mm (13") reel</p> <p>B = Bulk pack - tubs</p> <p>Q = Waffle pack</p>	Used for specific customer requirements

Notes:

- (1) Termination **A**, **H** & **F** available for Space applications. If another termination type is required then contact Syfer Sales.
- (2) Please include Lot Acceptance Test requirement (LAT1, LAT2 or LAT3) on purchase order against each line item. Tests conducted after 100% Burn-In (2xRV @125°C for 168 hours):
 - LAT1: 4 x adhesion, 8 x rapid temp change + LAT2 and LAT3.
 - LAT2: 20 x 1000 hour life test + LAT3.
 - LAT3: 6 x TC and 4 x solderability.

Safety Certified capacitors

Syfer Technology's Safety Certified capacitors comply with international UL and TÜV specifications to offer designers the option of using a surface mount ceramic multilayer capacitor to replace leaded film types. Offering the benefits of simple pick-and-place assembly, reduced board space required and lower profile, they are also available in a FlexiCap™ version to reduce the risk of mechanical cracking.

Syfer's high voltage capacitor expertise means the range offers among the highest range available of capacitance values in certain case sizes. Applications include: modems, AC-DC power supplies and where lightning strike or other voltage transients represent a threat to electronic equipment.

- Surface mount multilayer ceramic capacitors
- Meet Class Y2/X1, Y3/X2 and X2 requirements
- Approved for mains ac voltages, up to 250Vac
- Approved by UL and TÜV
- Sizes 1808, 1812, 2211, 2215 and 2220
- Smaller sizes suitable for use in equipment certified to EN60950
- Certification specifications for larger sizes include IEC/EN60384, UL/CSA60950 and UL1414
- Surface mount package
- Reduces board area and height restrictions
- Reduced assembly costs over conventional through hole components
- FlexiCap™ option available on all sizes.

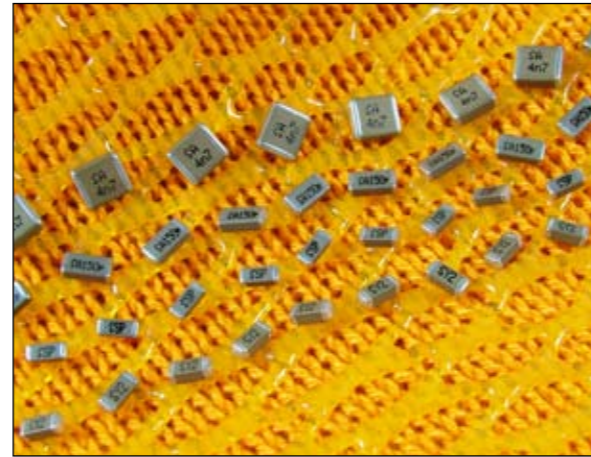

Class	Rated voltage	Impulse voltage	Insulation bridging	May be used in primary circuit
Y1	250Vac	8000V	Double or reinforced	Line to protective earth
Y2	250Vac	5000V	Basic or supplementary*	Line to protective earth
Y3	250Vac	None	Basic or supplementary	-
Y4	150Vac	2500V	Basic or supplementary*	Line to protective earth
X1	250Vac	4000V	-	Line to line
X2	250Vac	2500V	-	Line to line
X3	250Vac	None	-	Line to line

* 2 x Y2 or Y4 rated may bridge double or reinforced insulation when used in series.

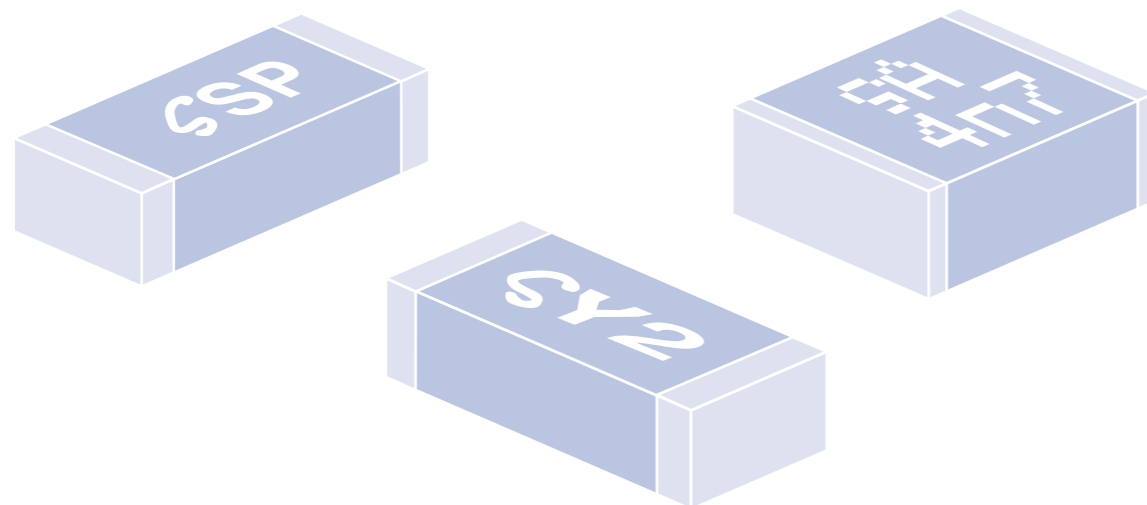

Safety Certified capacitors classification and approval specification.

CHIP SIZE	DIELECTRIC	CAP RANGE	SYFER FAMILY CODE	CLASSIFICATION	APPROVAL SPECIFICATION	APPROVAL BODY
1808	COG/NPO	4.7pF to 1.5nF	SP ⁽¹⁾	Y3/X2 NWGQ2, NWGQ8	IEC60384-14:2005 EN60384-14:2005 UL-60950-1, 2nd Ed CSA 60950-1-07 2nd Ed	TÜV UL
1808	X7R	150pF to 2.2nF	SP ⁽¹⁾	Y3/X2 NWGQ2, NWGQ8	IEC60384-14:2005 EN60384-14:2005 UL-60950-1, 2nd Ed CSA 60950-1-07 2nd Ed	TÜV UL
1808	COG/NPO	4.7pF to 390pF	PY2 ⁽¹⁾	Y2/X1 NWGQ2, NWGQ8	IEC60384-14:2005 EN60384-14:2005 UL-60950-1, 2nd Ed CSA 60950-1-07 2nd Ed	TÜV UL
1808	X7R	150pF to 1nF	PY2 ⁽¹⁾	Y2/X1 NWGQ2, NWGQ8	IEC60384-14:2005 EN60384-14:2005 UL-60950-1, 2nd Ed CSA 60950-1-07 2nd Ed	TÜV UL
1812	COG/NPO	4.7pF to 390pF	PY2 ⁽¹⁾	Y2/X1 NWGQ2, NWGQ8	IEC60384-14:2005 EN60384-14:2005 UL-60950-1, 2nd Ed CSA 60950-1-07 2nd Ed	TÜV UL
1812	X7R	150pF to 1.0nF	PY2 ⁽¹⁾	Y2/X1 NWGQ2, NWGQ8	IEC60384-14:2005 EN60384-14:2005 UL-60950-1, 2nd Ed CSA 60950-1-07 2nd Ed	TÜV UL
2211	COG/NPO	4.7pF to 1nF	SP ⁽²⁾	Y2/X1 NWGQ2, NWGQ8	IEC60384-14:2005 EN60384-14:2005 UL-60950-1, 2nd Ed CSA 60950-1-07 2nd Ed	TÜV UL
2211	X7R	100pF to 2.2nF	SP ⁽²⁾	Y2/X1 NWGQ2, NWGQ8	IEC60384-14:2005 EN60384-14:2005 UL-60950-1, 2nd Ed CSA 60950-1-07 2nd Ed	TÜV UL
2215	COG/NPO	820pF to 1.0nF	SP ⁽²⁾	Y2/X1 NWGQ2, NWGQ8	IEC60384-14:2005 EN60384-14:2005 UL-60950-1, 2nd Ed CSA 60950-1-07 2nd Ed	TÜV UL
2215	X7R	2.7nF to 3.3nF	SP ⁽²⁾	Y2/X1 NWGQ2, NWGQ8	IEC60384-14:2005 EN60384-14:2005 UL-60950-1, 2nd Ed CSA 60950-1-07 2nd Ed	TÜV UL
2220	X7R	150pF to 4.7nF	B16	Y2/X1 ⁽²⁾ Y2/X1, ⁽¹⁾ FOWX2	IEC60384-14:2005 EN60384-14:2005 UL1414: 6th Edition	TÜV UL
2220	X7R	150pF to 10nF	B17 ⁽²⁾	X2	IEC60384-14:2005 EN60384:2005	TÜV

- Notes**
- (1), (2) J: Silver base with Nickel Barrier (100% Matte Tin Plating). RoHS compliant.
 (1), (2) Y: FlexiCap™ termination base with Nickel Barrier (100% Tin Plating). RoHS compliant.
 (2) H: FlexiCap™ termination base with Nickel Barrier (Tin/ Lead plating with min 10% Lead).
 (2) A: Silver base with Nickel Barrier (Tin/ Lead Plating with min 10% Lead).
 PY2 Unmarked capacitors also available as released in accordance with approval specifications. Family code SY2 applies.
 SP Unmarked capacitors also available as released in accordance with approval specifications. Family code SPU applies.



Ordering information - Safety Certified capacitors - Class SPU/SP ranges

1808	J	A25	0102	J	C	T	SP
Chip size	Termination	Voltage	Capacitance in picofarads (pF)	Capacitance tolerance	Dielectric codes	Packaging	Suffix
1808 2211 2215	J = Nickel barrier Y = FlexiCap™ termination base with nickel barrier (100% matte tin plating). RoHS compliant. 2211/2215 only A = Silver base with nickel barrier (Tin/lead plating with min. 10% lead). H = FlexiCap™ termination base with Ni barrier (Tin/lead plating with min. 10% lead).	A25 = 250Vac	First digit is 0. Second and third digits are significant figures of capacitance code. The fourth digit is number of zeros following. Example: 0102 = 1.0nF	<10pF C = ±0.25pF D = ±0.5pF ≥ 10pF F = ±1% G = ±2% J = ±5% K = ±10% M = ±20%	C = COG/NPO X = X7R	T = 178mm (7") reel R = 330mm (13") reel B = Bulk pack - tubs	SP = Surge Protection capacitors (marked and approved) SPU = Surge Protection capacitors (un-marked parts are in accordance with, but not certified)



Ordering information - Safety Certified capacitors - Class PY2/SY2

1808	J	A25	0102	J	X	T	PY2
Chip size	Termination	Voltage	Capacitance in picofarads (pF)	Capacitance tolerance	Dielectric codes	Packaging	Suffix
1808 1812	J = Nickel barrier Y = FlexiCap™ termination base with nickel barrier (100% matte tin plating). RoHS compliant.	A25 = 250Vac	First digit is 0. Second and third digits are significant figures of capacitance code. The fourth digit is number of zeros following. Example: 0102 = 1.0nF	<10pF C = ±0.25pF D = ±0.5pF ≥ 10pF F = ±1% G = ±2% J = ±5% K = ±10% M = ±20%	C = COG/NPO X = X7R	T = 178mm (7") reel R = 330mm (13") reel B = Bulk pack - tubs	PY2 = Safety tested Surge Protection capacitors (marked and approved) SY2 = Surge Protection capacitors (un-marked parts are in accordance with, but not certified)



Ordering information - Safety Certified capacitors - Class B16/B17 ranges

2220	J	A25	0102	J	X	T	B16
Chip size	Termination	Voltage	Capacitance in picofarads (pF)	Capacitance tolerance	Dielectric codes	Packaging	Suffix
2220	J = Nickel barrier Y = FlexiCap™ termination base with nickel barrier (100% matte tin plating). RoHS compliant. A = Silver base with nickel barrier (Tin/lead plating with min. 10% lead). H = FlexiCap™ termination base with Ni barrier (Tin/lead plating with min. 10% lead).	A25 = 250Vac	First digit is 0. Second and third digits are significant figures of capacitance code. The fourth digit is number of zeros following. Example: 0471 = 470pF	J = ±5% K = ±10% M = ±20%	X = X7R	T = 178mm (7") reel 1000 pieces R = 330mm (13") reel 4000 pieces B = Bulk	B16 = Type A: X1/Y2 B17 = Type B: X2



Industry wide standard multilayer ceramic capacitors are supplied with a DC rating only. For AC use, Surge and Safety capacitors with an AC rating of 250Vac have been available but the capacitance range is limited as a result of the strict impulse and VP requirements in the international standards. Syfer Technology have developed a range which provides a solution for use at up to 250Vac 60Hz continuous use and provides for non safety-critical applications where extended capacitance ranges are required.

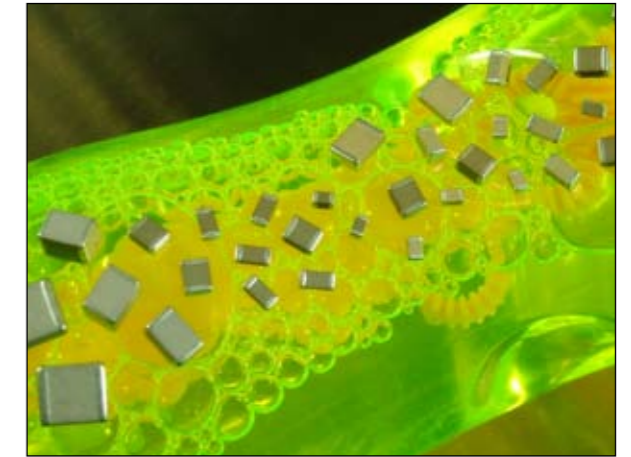

Capacitance range

Case sizes 0805 to 2220 are available in both X7R and COG/NPO dielectrics with capacitances of up to 120nF. The capacitance ranges are divided into four groups which are based on the voltage coefficient of capacitance, COG/NPO which has negligible capacitance shift with applied voltage and three subgroups of X7R. Type A with ±30% maximum capacitance shift 0V-240V, Type B with +30% to

-50% maximum capacitance shift 0V-240V and Type C with +30 to -80% maximum capacitance shift 0V to 240V.

Chip size	0805	1206	1210	1808	1812	2220
COG/NPO	1.0pF - 470pF	1.0pF - 1.2nF	4.7pF - 2.2nF	4.7pF - 2.2nF	10pF - 5.6nF	10pF - 10nF
X7R A ±30%	560pF - 1.5nF	1.5nF - 10nF	2.7nF - 22nF	2.7nF - 22nF	6.8nF - 56nF	12nF - 120nF
X7R B +30% -50%	1.8nF - 3.3nF	12nF	27nF	27nF	68nF - 82nF	-
X7R C +30% -80%	3.9nF - 10nF	15nF - 47nF	33nF - 100nF	33nF - 100nF	100nF - 120nF	-

NOTE: X7R A) has a VCC of ± 30% over 0 to 240Vac 50Hz
X7R B) has a VCC of +30% to -50% over 0 to 240Vac 50Hz
X7R C) has a VCC of +30% to -80% over 0 to 240Vac 50Hz
Measurement conditions described in Syfer Application Notes AN0033

Ordering information - 250Vac Non Safety Rated AC capacitors

1812	Y	A25	0103	K	X	T
Chip size	Termination	Voltage	Capacitance in picofarads (pF)	Capacitance tolerance	Dielectric codes	Packaging
0805 1206 1210 1808 1812 2220	Y = FlexiCap™ J = Nickel Barrier	250Vac 60Hz	<10pF Insert a P for the decimal point, eg P300 = 0.3pF, 8P20 = 8.2pF. ≥10pF 1st digit is 0. 2nd and 3rd digits are significant figures of capacitance code. The 4th digit is number of 0's following eg. 0103 = 10000pF Values <1pF in 0.1pF steps, above this values are E24 series	<10pF B = ±0.1pF C = ±0.25pF D = ±0.5pF ≥10pF F = ±1% G = ±2% J = ±5% K = ±10%	C = COG/NPO X = X7R	T = 178mm (7") reel R = 330mm (13") reel B = Bulk pack - tubs

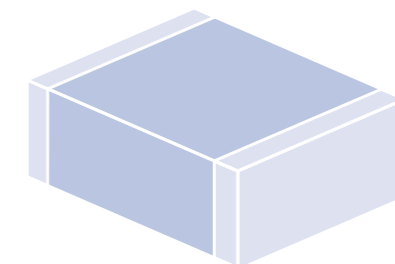
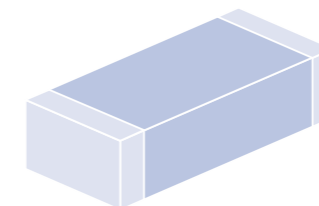

115Vac 400Hz Capable capacitors for aerospace applications

Syfer Technology has conducted reliability testing on standard surface mount ceramic capacitors in order to ensure their performance at 115Vac 400Hz and the associated voltage and frequency transients required by MIL-STD-704. Self heating will occur due to losses in the capacitor but has been measured at less than 25°C rise with neutral mounting conditions at room temperature.

115Vac 400Hz Capable capacitor range

	0805	1206	1210	1808	1812	2220
Dielectric	Capacitance values					
COG/NPO	330pF	1.5nF	3.9nF	3.9nF	10nF	15nF
X7R	4.7nF	18nF	39nF	39nF	82nF	100nF

Ordering information - 115Vac 400Hz Capable capacitors

1206	Y	A12	0103	J	X	T
Chip size	Termination	Voltage	Capacitance in picofarads (pF)	Capacitance tolerance	Dielectric codes	Packaging
0805 1206 1210 1808 1812 2220	J = Nickel barrier Y = FlexiCap™ A = (Tin/lead) H = FlexiCap™ (Tin/lead)	A12 = 115Vac	First digit is 0. Second and third digits are significant figures of capacitance code. The fourth digit is number of zeros following. Example: 0103 = 10nF	<4.7pF H = ±0.05pF B = ±0.1pF C = ±0.25pF D = ±0.5pF ≥4.7pF & <10pF B = ±0.1pF C = ±0.25pF D = ±0.5pF >10pF F = ±1% G = ±2% J = ±5% K = ±10%	C = COG/NPO X = X7R	T = 178mm (7") reel R = 330mm (13") reel B = Bulk pack - tubs

High Dielectric Withstand Voltage capacitors (DWV range)

The Syfer DWV range is specifically designed for use in applications where a high Dielectric Withstand Voltage (DWV) is required.

These parts have a continuous rated voltage of 500Vdc minimum and are 100% DWV tested at the specified voltages to ensure Flashover (arcing) across the surface does not occur.

- High dielectric withstand voltages (DWV) of 1.5kV and 2.5kV
- These ratings are based on an application of the DWV voltage for a period of up to 60 seconds (where the charging current is limited to 50mA)
- Case sizes 1206 to 2225
- COG/NPO and X7R dielectrics



- Capacitance values from 4.7pF to 120nF
- For full range information please see Syfer web site, or contact our Sales Office.

Ordering information - DWV capacitors

1812	J	1K5	0820	K	C	T	DWV
Chip size	Termination	Dielectric Withstand Voltage	Capacitance in picofarads (pF)	Capacitance tolerance	Dielectric codes	Packaging	Suffix
1206 1210 1808 1812 2220 2225	J = Nickel barrier Y = FlexiCap™	1K5 = 1500V 2K5 = 2500V	First digit is 0. Second and third digits are significant figures of capacitance code. The fourth digit is number of zeros following. Example: 0820 = 82pF	J = ±5% K = ±10% M = ±20%	C = COG/NPO X = X7R	T = 178mm (7") reel R = 330mm (13") reel B = Bulk pack - tubs	Dielectric Withstand Voltage

Syfer Technology has developed a range of surface mount multilayer ceramic capacitors aimed specifically at the LCD inverter market. The advantage gained over standard product is a reduced susceptibility to surface arcing which allows for the replacement of leaded components. The improved properties are achieved by the utilisation of a unique COG/NPO dielectric material.

Parts for these applications are identified with the suffix code FB9.

Users should carefully consider solder pad design as this can influence arcing voltage.



Capacitance range

	1808	1812
5kV	1.5pF - 22pF	3.9pF - 68pF
6kV	1.5pF - 12pF	3.9pF - 33pF

Ordering information - LCD Inverter range

1808	Y	5K0	0220	J	C	T	FB9
Chip size	Termination	Voltage d.c.	Capacitance in picofarads (pF)	Capacitance tolerance	Dielectric codes	Packaging	Suffix
1808 1812	Y = FlexiCap™ termination base with Nickel barrier (100% matte tin plating). RoHS compliant. J = Nickel barrier.	5K0 = 5kV 6K0 = 6kV	<1.0pF Insert a P for the decimal point as the first character. eg. P300 = 0.3pF Values in 0.1pF steps ≥1.0pF & <10pF Insert a P for the decimal point as the second character. eg. 8P20 = 8.2pF Values are E24 series ≥10pF First digit is 0. Second and third digits are significant figures of capacitance code. Fourth digit is number of zeros eg. 0101 = 100pF Values are E24 series	<10pF B = ±0.1pF C = ±0.25pF D = ±0.5pF ≥10pF F = ±1% G = ±2% J = ±5% K = ±10%	C = COG/NPO	T = 178mm (7") reel R = 330mm (13") reel B = Bulk pack - tubs	LCD Inverter range

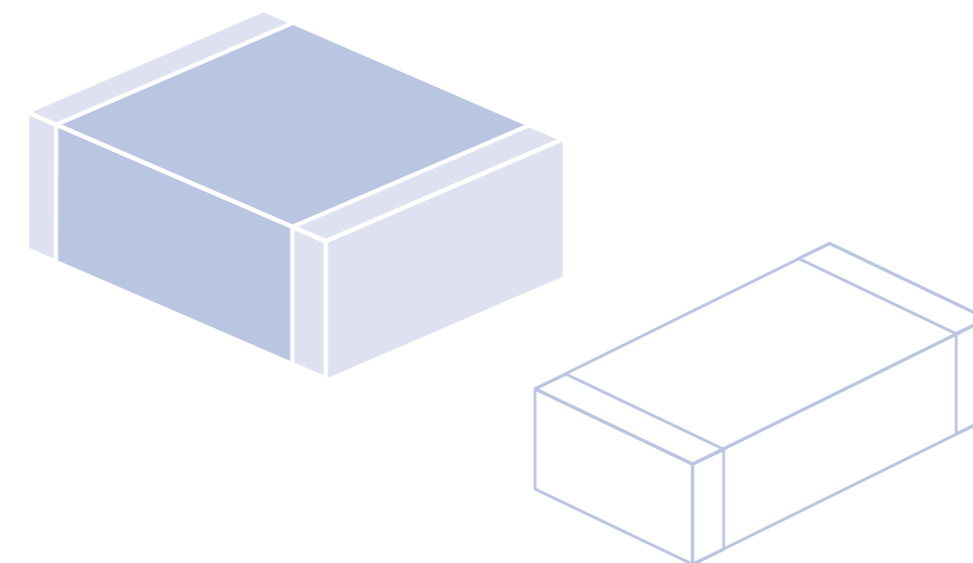

The Syfer E01 and E07 ranges of feedthrough MLCC chip 'C' filters are 3 terminal chip devices designed to offer reduced inductance compared to conventional MLCC's when used in signal line filtering.

The filtered signal passes through the chip internal electrodes and the noise is filtered to the grounded side contacts, resulting in reduced length noise transmission paths.

Available in COG/NPO and X7R dielectrics, with current ratings of 300mA, 1A, 2A and voltage ratings of 25Vdc to 200Vdc. Also available with FlexiCap™ termination which is strongly recommended for new designs.

Commonly used in automotive applications, a range qualified to AECQ-200 is also available.

E01 300mA, **E07** 1A/2A

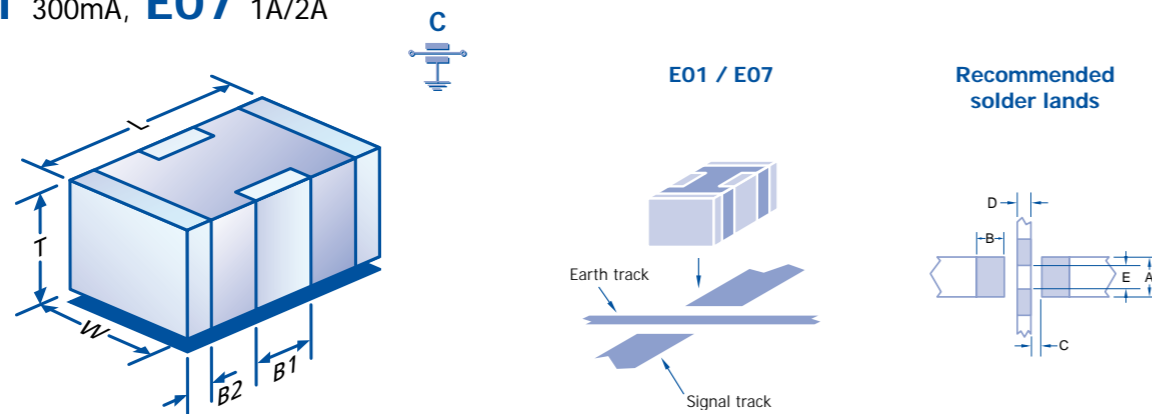

Dimensions

	0603	0805	1206	1806		0603	0805	1206	1806
L	1.6 ± 0.2 (0.063 ± 0.008)	2.0 ± 0.3 (0.079 ± 0.012)	3.2 ± 0.3 (0.126 ± 0.012)	4.5 ± 0.35 (0.177 ± 0.014)	A	0.6 (0.024)	0.95 (0.037)	1.2 (0.047)	1.2 (0.047)
W	0.8 ± 0.2 (0.031 ± 0.008)	1.25 ± 0.2 (0.049 ± 0.008)	1.6 ± 0.2 (0.063 ± 0.008)	1.6 ± 0.2 (0.063 ± 0.008)	B	0.6 (0.024)	0.9 (0.035)	0.9 (0.035)	1.4 (0.055)
T	0.5 ± 0.15 (0.02 ± 0.006)	1.0 ± 0.15 (0.039 ± 0.006)	1.1 ± 0.2 (0.043 ± 0.008)	1.1 ± 0.2 (0.043 ± 0.008)	C	0.4 (0.016)	0.3 (0.012)	0.6 (0.024)	0.8 (0.031)
B1	0.3 ± 0.2 (0.012 ± 0.008)	0.60 ± 0.2 (0.024 ± 0.008)	0.95 ± 0.3 (0.037 ± 0.012)	1.4 ± 0.3 (0.055 ± 0.012)	D	0.2 (0.008)	0.4 (0.016)	0.8 (0.031)	1.4 (0.055)
B2	0.2 ± 0.1 (0.008 ± 0.004)	0.3 ± 0.15 (0.012 ± 0.006)	0.5 ± 0.25 (0.02 ± 0.01)	0.5 ± 0.25 (0.02 ± 0.01)	E	0.4 (0.016)	0.75 (0.030)	1.0 (0.039)	1.4 (0.055)

- Notes: 1) All dimensions mm (inches).
- 2) Pad widths less than chip width gives improved mechanical performance.
- 3) The solder stencil should place 4 discrete solder pads. The unprinted distance between ground pads is shown as dim E.
- 4) Insulating the earth track underneath the filters is acceptable and can help avoid displacement of filter during soldering but can result in residue entrapment under the chip.

Type	E01				E07				
Chip Size	0603	0805	1206	1806	0603	0805	1206	1806	
Max Current	300mA	300mA	300mA	300mA	1A	2A	2A	2A	
Rated Voltage	Dielectric								
Minimum and maximum capacitance values									
25Vdc	COG/NPO	150pF-390pF	180pF-1.5nF	560pF-3.9nF	820pF-4.7nF	150pF-390pF	180pF-1.5nF	560pF-3.9nF	820pF-4.7nF
	X7R	6.8nF-18nF	470pF-100nF	5.6nF-330nF	3.9nF-560nF	6.8nF-18nF	820pF-100nF	10nF-330nF	22nF-560nF
50Vdc	COG/NPO	10pF-56pF	22pF-820pF	22pF-3.3nF	22pF-3.9nF	12pF-56pF	10pF-220pF	22pF-1nF	100pF-2.2nF
	X7R	2.7nF-12nF	560pF-68nF	4.7nF-220nF	3.3nF-330nF	2.7nF-12nF	1nF-68nF	10nF-220nF	22nF-330nF
100Vdc	COG/NPO	-	22pF-560pF	22pF-2.2nF	22pF-3.3nF	-	10pF-120pF	22pF-560pF	100pF-680pF
	X7R	-	560pF-27nF	1.8nF-100nF	3.3nF-180nF	-	1nF-27nF	10nF-100nF	22nF-180nF
200Vdc	COG/NPO	-	-	560pF-1.2nF	56pF-1nF	-	-	15pF-180pF	56pF-470pF
	X7R	-	-	2.7nF-56nF	3.9nF-100nF	-	-	12nF-56nF	22nF-100nF

- Notes: 1) E01 ranges in red available as qualified AEC-Q200.
- 2) E07 25Vdc COG/NPO 0805 to 1806 ranges in green, have maximum current of 1A.

Open board insertion loss performance in 50Ω system

Open Board Performance						
Capacitance	0.1MHz	1MHz	10MHz	100MHz	1GHz	Resonance Freq (MHz) approx.
10pF	0	0	0	0	7.5	2200
22pF	0	0	0	0	16	1600
33pF	0	0	0	1	22	1350
47pF	0	0	0	2	28	1150
68pF	0	0	0	3	41	900
100pF	0	0	0	5	28	800
150pF	0	0	0	8	24	700
220pF	0	0	0	12	20	600
330pF	0	0	1	15	20	500
470pF	0	0	2	18	20	425
560pF	0	0	3	20	20	350
680pF	0	0	4	22	20	300
820pF	0	0	5	24	20	260
1nF	0	0	7	27	20	220
1.5nF	0	0	9	31	20	200
2.2nF	0	0	12	34	20	170
3.3nF	0	1	14	39	20	135
4.7nF	0	2	18	46	20	110
6.8nF	0	3	21	50	20	90
10nF	0	5	24	48	20	80
15nF	0	8	27	45	20	65
22nF	0	12	31	43	20	56
33nF	1	14	34	40	20	40
47nF	2	17	38	40	20	34
68nF	4	20	41	40	20	30
100nF	6	24	45	40	20	28
150nF	8	26	48	40	20	24
220nF	10	30	52	40	20	17
330nF	13	33	55	40	20	15.5
470nF	16	36	60	40	20	14
560nF	18	39	65	40	20	12

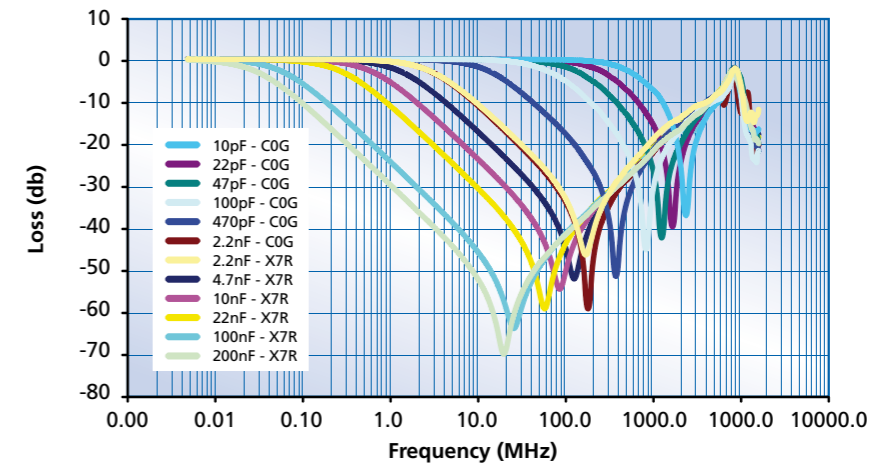

Ordering Information - E01 & E07 feedthrough capacitors

1206	Y	100	0103	M	X	T	E07
Chip Size	Termination	Voltage	Capacitance in picofarads (pF)	Tolerance	Dielectric	Packaging	Type
0603 0805 1206 1806	J = Nickel Barrier (Tin) Y = FlexiCap™ (Tin) A = (Tin/Lead) H = FlexiCap™ (Tin/Lead)	025 = 25Vdc 050 = 50Vdc 100 = 100Vdc 200 = 200Vdc	First digit is 0. Second and third digits are significant figures of capacitance code. The fourth digit is number of zeros following. Example: 0103=10000pF.	M = ±20%	A = COG/NPO AEC-Q200 C = COG/NPO AEC-Q200 E = X7R X = X7R	T = 178mm (7") reel R = 330mm (13") reel B = Bulk	E01 E07

Reeled quantities	178mm (7") reel			330mm (13") reel		
	0805	1206	1806	0805	1206	1806
	3000	2500	2500	12000	10000	10000

X2Y

The Syfer X2Y Integrated Passive Component is a 3 terminal EMI chip device.

When used in balanced line applications, the revolutionary design provides simultaneous line-to-line and line-to-ground filtering, using a single ceramic chip. In this way, differential and common mode filtering are provided in one device.

For unbalanced applications, it provides ultra low ESL (equivalent series inductance). Capable of replacing 2 or more conventional devices, it is ideal for balanced and unbalanced lines, twisted pairs and dc motors, in automotive, audio, sensor and other applications.

Available in sizes from 0603 to 2220, these filters can prove invaluable in meeting stringent EMC demands.

Manufactured in the UK by Syfer Technology Limited under licence from X2Y attenuators LLC.



Dielectric
X7R or COG/NPO

Electrical configuration
Multiple capacitance

Capacitance measurement
At 1000hr point

Typical capacitance matching
Better than 5%

Temperature rating
-55°C to 125°C

Insulation resistance
100Gohms or 1000s (whichever is the less)

Dielectric withstand voltage
≤200V 2.5 times rated Volts for 5 secs
500V 1.5 times rated Volts for 5 secs
Charging current limited to 50mA Max.

Type		E03					
Chip size		0603	0805	1206	1410	1812	2220
Rated voltage	Dielectric	Minimum and maximum capacitance values					
16Vdc	COG/NPO	150pF	-	-	-	-	-
	X7R	15nF	-	-	-	-	-
25Vdc	COG/NPO	120pF	560pF - 820pF	1.8nF - 3.3nF	6.8nF - 8.2nF	12nF - 15nF	22nF - 33nF
	X7R	12nF	56nF - 68nF	-	470nF	820nF	1.2μF
50Vdc	COG/NPO	10pF - 100pF	390pF - 470pF	1.2nF - 1.5nF	4.7nF - 5.6nF	8.2nF - 10nF	18nF
	X7R	150pF - 10nF	18nF - 47nF	56nF - 220nF	180nF - 400nF	390nF - 680nF	560nF - 1.0μF
100Vdc	COG/NPO	-	10pF - 330pF	22pF - 1.0nF	100pF - 3.9nF	820pF - 6.8nF	1.0nF - 15nF
	X7R	-	470pF - 15nF	1.5nF - 47nF	4.7nF - 150nF	8.2nF - 330nF	10nF - 470nF
200Vdc	COG/NPO	-	-	22pF - 1.0nF	100pF - 3.3nF	820pF - 5.6nF	1.0nF - 15nF
	X7R	-	-	820pF - 33nF	1.2nF - 120nF	2.7nF - 180nF	4.7nF - 470nF
500Vdc	COG/NPO	-	-	-	-	820pF - 3.9nF	1.0nF - 10nF
	X7R	-	-	-	-	2.7nF - 100nF	4.7nF - 180nF

Notes: 1) For some lower capacitance parts, higher voltage rated parts may be supplied.

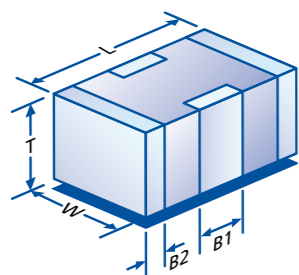

	0603	0805	1206	1410	1812	2220
L	1.6±0.2 (0.063±0.008)	2.0±0.3 (0.08±0.012)	3.2±0.3 (0.126±0.012)	3.6±0.3 (0.14±0.012)	4.5±0.35 (0.18±0.014)	5.7±0.4 (0.22±0.016)
W	0.8±0.2 (0.03±0.008)	1.25±0.2 (0.05±0.008)	1.60±0.2 (0.063±0.008)	2.5±0.3 (0.1±0.012)	3.2±0.3 (0.126±0.012)	5.0±0.4 (0.2±0.016)
T	0.5±0.15 (0.02±0.006)	1.0±0.15 (0.04±0.006)	1.1±0.2 (0.043±0.008)	2.0 max. (0.08 max.)	2.1 max. (0.08 max.)	2.5 max. (0.1 max.)
B1	0.4±0.15 (0.016±0.006)	0.5±0.25 (0.02±0.01)	0.95±0.3 (0.037±0.012)	1.20±0.3 (0.047±0.012)	1.4±0.35 (0.06±0.014)	2.25±0.4 (0.09±0.016)
B2	0.25±0.15 (0.010±0.006)	0.3±0.15 (0.012±0.006)	0.5±0.25 (0.02±0.01)	0.5±0.25 (0.02±0.01)	0.75±0.25 (0.03±0.01)	0.75±0.25 (0.03±0.01)

Notes: 1) All dimensions mm (Inches).
2) Pad widths less than chip width gives improved mechanical performance.
3) The solder stencil should place 4 discrete solder pads. The un-printed distance between ground pads is shown as dim E.
4) Insulating the earth track underneath the filters is acceptable and can help avoid displacement of filter during soldering but can result in residue entrapment under the chip.

Recommended solder lands

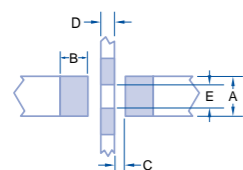

	0603	0805	1206	1410	1812	2220
A	0.6 (0.024)	0.95 (0.037)	1.2 (0.047)	2.05 (0.08)	2.65 (0.104)	4.15 (0.163)
B	0.6 (0.024)	0.9 (0.035)	0.9 (0.035)	1.0 (0.040)	1.4 (0.055)	1.4 (0.055)
C	0.4 (0.016)	0.3 (0.012)	0.6 (0.024)	0.7 (0.028)	0.8 (0.031)	1.2 (0.047)
D	0.2 (0.008)	0.4 (0.016)	0.8 (0.031)	0.9 (0.035)	1.4 (0.055)	1.8 (0.071)
E	0.4 (0.016)	0.75 (0.030)	1.0 (0.039)	1.85 (0.071)	2.05 (0.080)	3.95 (0.156)

AEC-Q200 range (E03) - capacitance values

Chip size		0805	1206	1410	1812
50Vdc	COG/NPO	390pF - 470pF	1.2nF - 1.5nF	4.7nF - 5.6nF	8.2nF - 10nF
	X7R	18nF - 33nF	56nF - 150nF	180nF - 330nF	390nF - 560nF
100Vdc	COG/NPO	10pF - 330pF	22pF - 1.0nF	100pF - 3.9nF	820pF - 6.8nF
	X7R	470pF - 15nF	1.5nF - 47nF	4.7nF - 150nF	8.2nF - 330nF

Component	Advantages	Disadvantages	Applications
Chip capacitor	Industry standard	Requires 1 per line High inductance Capacitance matching problems	By-pass Low frequency
3 terminal feedthrough	Feedthrough Lower inductance	Current limited	Feedthrough Unbalanced lines High frequency
Syfer X2Y Integrated Passive Component	Very low inductance Replaces 2 (or 3) components Negates the effects of temperature, voltage and ageing Provides both common mode and differential mode attenuation Can be used on balanced & unbalanced lines	Care must be taken to optimise circuit design	By-pass Balanced lines High frequency dc electric motors Unbalanced lines Audio amplifiers CANBUS

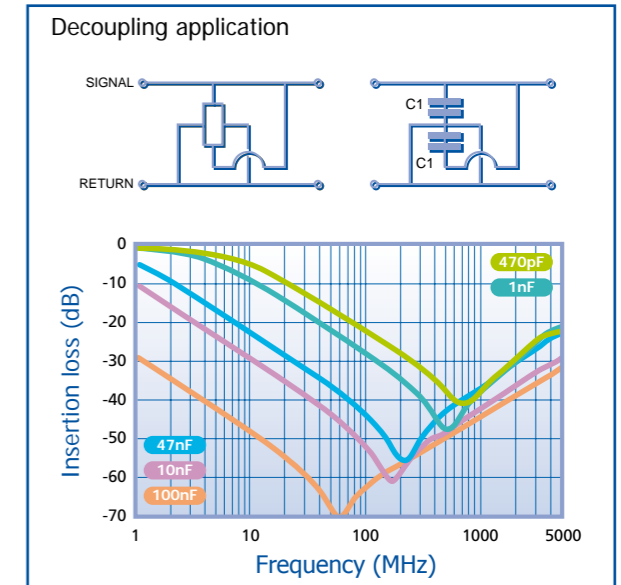
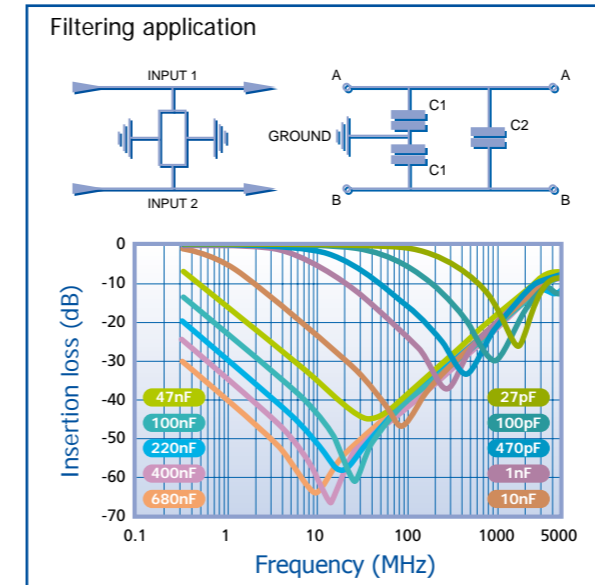

Ordering information

1812	Y	100	0334	M	X	T	E03
Chip Size	Termination	Voltage	Capacitance in picofarads (pF) C ₁	Tolerance	Dielectric	Packaging	Type
0603 0805 1206 1410 1812 2220	J = Nickel barrier Y = FlexiCap™ A = (Tin/lead) H = FlexiCap™ (Tin/lead)	016 = 16Vdc 025 = 25Vdc 050 = 50Vdc 100 = 100Vdc 200 = 200Vdc 500 = 500Vdc	First digit is 0. Second and third digits are significant figures of capacitance code. The fourth digit is number of zeros following Example: 0334=330nF. Note: C ₁ = 2C ₂	M = ±20% (Tighter tolerances may be available on request).	A = COG/NPO AEC-Q200 C = COG/NPO E = X7R AEC-Q200 X = X7R	T = 178mm (7") reel R = 330mm (13") reel B = Bulk	Syfer X2Y Integrated Passive Component

Reeled quantities

178mm (7") reel	0603	0805	1206	1410	1812	2220	330mm (13") reel	0603	0805	1206	1410	1812	2220
	4000	3000	2500	2000	1000	1000		16000	12000	10000	8000	4000	4000

Tape and reel packing of surface mounting chip capacitors for automatic placement are in accordance with IEC60286-3.

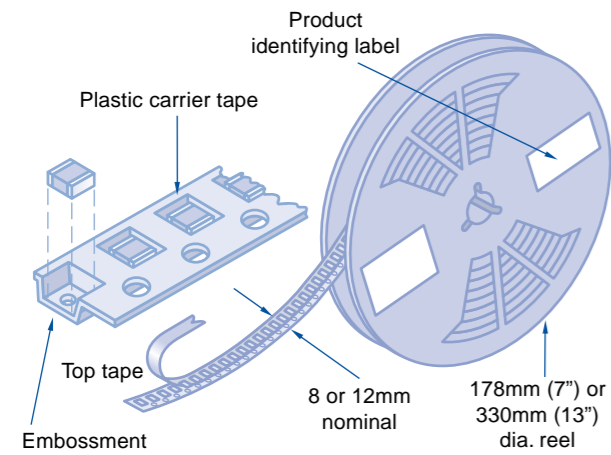

Peel force

The peel force of the top sealing tape is between 0.2 and 1.0 Newton at 180°. The breaking force of the carrier and sealing tape in the direction of unreeling is greater than 10 Newtons.

Tape dimensions

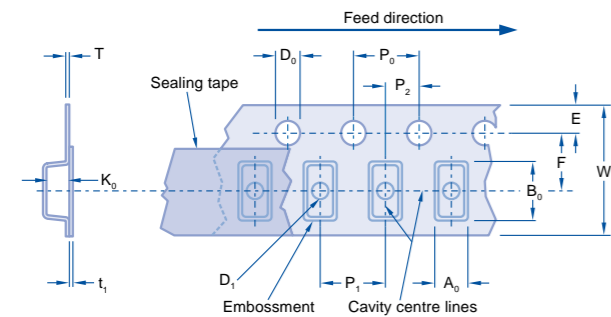

Symbol	Description	Dimensions mm (inches)	
		8mm tape	12mm tape
A ₀	Width of cavity	Dependent on chip size to minimize rotation	
B ₀	Length of cavity	Dependent on chip size to minimize rotation	
K ₀	Depth of cavity	Dependent on chip size to minimize rotation	
W	Width of tape	8.0 (0.315)	12.0 (0.472)
F	Distance between drive hole centres and cavity centres	3.5 (0.138)	5.5 (0.213)
E	Distance between drive hole centres and tape edge	1.75 (0.069)	
P ₁	Distance between cavity centres	4.0 (0.156)	8.0 (0.315)
P ₂	Axial distance between drive hole centres and cavity centres	2.0 (0.079)	
P ₀	Axial distance between drive hole centres	4.0 (0.156)	
D ₀	Drive hole diameter	1.5 (0.059)	
D ₁	Diameter of cavity piercing	1.0 (0.039)	1.5 (0.059)
XT	Carrier tape thickness	0.3 (0.012) ±0.1 (0.004)	0.4 (0.016) ±0.1 (0.004)
Xt ₁	Top tape thickness	0.1 (0.004) max	

Reel dimensions mm (inches)

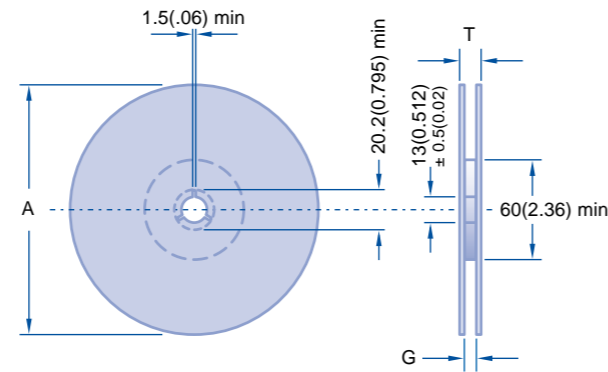

Symbol	Description	178mm reel	330mm reel
A	Reel diameter	178 (7)	330 (13)
G	Reel inside width	8.4 (0.33)	12.4 (0.49)
T	Reel outside width	14.4 (0.56) max	18.4 (0.72) max

Missing components

The number of missing components in the tape may not exceed 0.25% of the total quantity with not more than three consecutive components missing. This must be followed by at least six properly placed components.

Identification

Each reel is labelled with the following information: manufacturer, chip size, capacitance, tolerance, rated voltage, dielectric type, batch number, date code and quantity of components.

Leader and Trailer

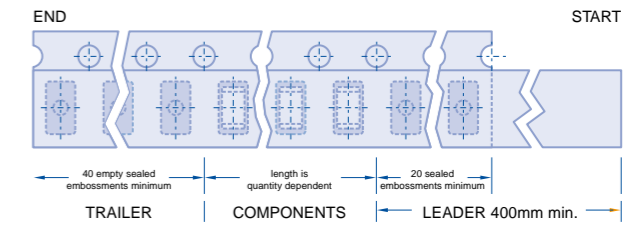

Component orientation

Tape and reeling is in accordance with IEC 60286 part 3, which defines the packaging specifications of leadless components on continuous tapes.

NOTES: 1) IEC60286 states $A_0 \leq B_0$ (see Tape Dimensions above).
2) Regarding the orientation of 1825 & 2225 components, the termination bands are right to left, NOT front to back. Please see diagram.

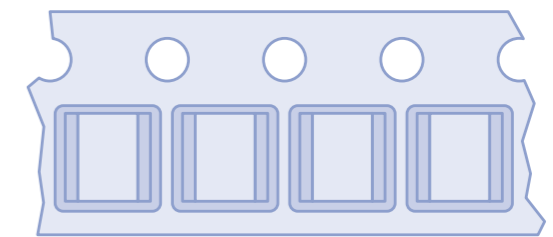

Orientation of 1825 & 2225 components

Outer Packaging

Outer Carton Dimensions mm (inches) max.

Reel Size	No. of reels	L	W	T
178 (7.0)	1	185 (7.28)	185 (7.28)	25 (0.98)
178 (7.0)	4	190 (7.48)	195 (7.76)	75 (2.95)
330 (13.0)	1	335 (13.19)	335 (13.19)	25 (0.98)

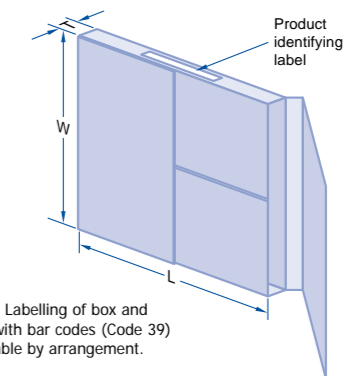

Note: Labelling of box and reel with bar codes (Code 39) available by arrangement.

Reel quantities

Chip size	0402	0505	0603	0805	1111	1206	1210	1410	1808	1812	1825	2211	2215	2220	2225
Max. chip thickness	0.5mm	1.3mm	0.8mm	1.3mm	2.0mm	1.6mm	2.0mm	2.0mm	2.0mm	2.5mm	2.5mm	2.5mm	2.5mm	2.5mm	2.5mm
	0.02"	0.05"	0.03"	0.05"	0.08"	0.06"	0.08"	0.08"	0.08"	0.1"	0.1"	0.1"	0.1"	0.1"	0.1"
Reel quantities	178mm (7")	5000	2500	4000	3000	1000	2500	2000	2000	1500	500/1000	500	750	500	500/1000
	330mm (13")	-	-	16000	12000	-	10000	8000	8000	6000	2000/4000	2000	-	4000	2000/4000

Notes:

- (1) The above quantities per reel are for the maximum manufactured chip thickness. Thinner chips can be taped in larger quantities per reel.
- (2) Where two different quantities are shown for the same case size, please contact the Sales Office to determine the exact quantity for any specific part number.

Bulk packing - tubs

Chips are supplied in rigid re-sealable plastic tubs together with impact cushioning wadding. Tubs are labelled with the details: chip size, capacitance, tolerance, rated voltage, dielectric type, batch number, date code and quantity of components.

Dimensions mm (inches)

H	60 (2.36)
D	50 (1.97)

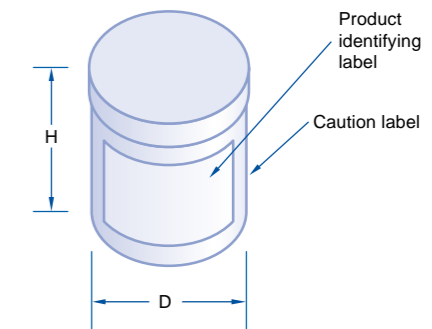

Radial Leaded capacitors

Syfer Technology produces a wide range of dipped radial leaded capacitors. These are available in rated voltages of 50V up to 6kV. Although our catalogue range extends to 6kV, we are able to offer a capability for specials up to 10kV. Our larger case sizes and high voltage versions are particularly in demand, especially for mil/aero and medical power supply applications. Please contact our Sales Office to discuss any special requirements. IECQ-CECC approved parts are also included within the ranges.

- High working voltage - up to 10kVdc
- Large case sizes
- RoHS compliant versions
- Tin-lead plated wire option to reduce tin whiskers (quote suffix A97 for 8111 to 8141 & A31 for 8151, 8161, 8171).

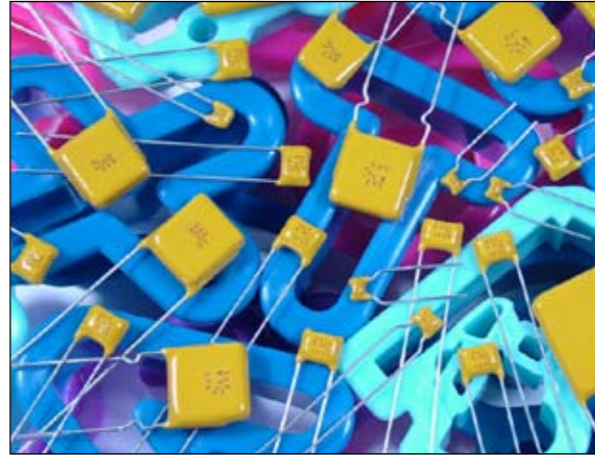

		8111M	8111N	8121M	8121N	8121T	8131M	8131M T = 6.3mm	8131T	8141M	8151M	8151M T = 6.3mm	8161M	8161M T = 7.0mm	8171M	8171M T = 7.0mm
Min. cap values	COG/NPO	4.7pF	4.7pF	4.7pF	4.7pF	4.7pF	4.7pF	-	10pF	4.7pF	10pF	-	39pF	-	68pF	-
	X7R	100pF	100pF	100pF	100pF	330pF	100pF	-	150pF	100pF	470pF	-	1.0nF	-	2.2nF	-
50/63V	COG/NPO	5.6nF	5.6nF	18nF	18nF	18nF	100nF	-	47nF	150nF	220nF	-	390nF	-	680nF	-
	X7R	220nF	220nF	1.0µF	1.0µF	1.0µF	3.3µF	-	2.2µF	4.7µF	8.2µF	-	10µF	-	15µF	-
100V	COG/NPO	2.7nF	2.7nF	12nF	12nF	12nF	68nF	-	27nF	100nF	180nF	-	330nF	-	560nF	-
	X7R	100nF	100nF	470nF	470nF	470nF	1.5µF	-	1.0µF	2.2µF	8.2µF	-	10µF	-	15µF	-
200/ 250V	COG/NPO	1.0nF	1.0nF	4.7nF	4.7nF	4.7nF	27nF	68nF	12nF	47nF	82nF	180nF	120nF	330nF	270nF	560nF
	X7R	56nF	56nF	220nF	220nF	220nF	1.0µF	-	470nF	1.0µF	1.5µF	-	3.9µF	-	8.2µF	-
500V	COG/NPO	470pF	470pF	3.9nF	3.9nF	3.9nF	22nF	47nF	10nF	33nF	56nF	120nF	100nF	270nF	180nF	470nF
	X7R	8.2nF	8.2nF	100nF	100nF	100nF	820nF	-	270nF	680nF	1.0µF	-	1.8µF	-	3.3µF	-
630V	COG/NPO	270pF	270pF	1.8nF	1.8nF	1.8nF	15nF	39nF	5.6nF	22nF	39nF	100nF	68nF	180nF	150nF	390nF
	X7R	4.7nF	4.7nF	27nF	27nF	27nF	390nF	-	150nF	470nF	680nF	-	1.2µF	-	2.2µF	-
1kV	COG/NPO	100pF	100pF	1.0nF	1.0nF	1.0nF	10nF	27nF	3.3nF	15nF	22nF	82nF	39nF	150nF	68nF	270nF
	X7R	3.3nF	3.3nF	15nF	15nF	15nF	150nF	-	56nF	150nF	180nF	-	390nF	-	1.0µF	-
1.2kV	COG/NPO	-	-	680pF	680pF	680pF	6.8nF	22nF	2.2nF	6.8nF	18nF	56nF	33nF	100nF	47nF	180nF
	X7R	-	-	10nF	10nF	10nF	100nF	-	33nF	100nF	150nF	-	220nF	-	470nF	-
1.5kV	COG/NPO	-	-	470pF	470pF	470pF	4.7nF	12nF	1.5nF	4.7nF	12nF	39nF	22nF	68nF	33nF	120nF
	X7R	-	-	6.8nF	6.8nF	6.8nF	68nF	-	22nF	68nF	100nF	-	150nF	-	330nF	-
2kV	COG/NPO	-	-	220pF	220pF	220pF	2.2nF	6.8nF	820pF	3.3nF	5.6nF	18nF	10nF	39nF	18nF	68nF
	X7R	-	-	4.7nF	4.7nF	4.7nF	33nF	-	10nF	47nF	47nF	-	82nF	-	150nF	-
2.5kV	COG/NPO	-	-	-	-	-	1.8nF	3.9nF	680pF	1.8nF	4.7nF	12nF	6.8nF	22nF	12nF	39nF
	X7R	-	-	-	-	-	12nF	-	3.3nF	12nF	33nF	-	68nF	-	100nF	-
3kV	COG/NPO	-	-	-	-	-	1.5nF	2.7nF	470pF	1.0nF	2.2nF	8.2nF	4.7nF	18nF	8.2nF	27nF
	X7R	-	-	-	-	-	6.8nF	-	2.7nF	10nF	18nF	-	39nF	-	68nF	-
4kV	COG/NPO	-	-	-	-	-	820pF	1.5nF	270pF	680pF	1.0nF	3.3nF	2.2nF	6.8nF	4.7nF	15nF
	X7R	-	-	-	-	-	5.6nF	-	2.2nF	5.6nF	6.8nF	-	15nF	-	33nF	-
5kV	COG/NPO	-	-	-	-	-	560pF	1.0nF	180pF	470pF	560pF	2.2nF	1.5nF	4.7nF	3.3nF	10nF
	X7R	-	-	-	-	-	4.7nF	-	1.2nF	3.3nF	3.9nF	-	8.2nF	-	18nF	-
6kV	COG/NPO	-	-	-	-	-	390pF	680pF	120pF	-	1.0nF	1.5nF	-	3.3nF	-	6.8nF
	X7R	-	-	-	-	-	2.7nF	-	1.0nF	1.0nF	2.7nF	-	-	-	-	-

Note: T = Maximum thickness.

Fixed Multilayer Ceramic Radial capacitor IECQ-CECC approvals

	Dipped
Climatic category:	55/125/21
Capacitance tolerances:	COG/NPO - 5%, 10% & 20% X7R - 10% & 20%
Approved rated voltages:	50V/63V, 100V & 200V

Dipped product approval range

CECC case size	Syfer product code	
A	8111M	
F	8111N	
B	8121M	
C	8121N	
D	8131M	
Dielectric	Capacitance range	CECC specification
COG/NPO	3.9pF to 27nF	CECC 30 601 008
X7R	100pF to 1.0µF	CECC 30 701 013

Radial Leaded capacitors

Dimensions - Dipped Radial

	CECC	Pattern	Width (X) max. mm inches	Height (Y) max. mm inches	Thickness (Z) max. mm inches	Lead Space (S) mm inches	Lead Diameter (d) mm inches
8111M	A	A	3.81 0.15	5.31 0.21	2.54 0.10	2.54±0.4 0.1±0.016	0.5±0.05 0.02±0.002
8111N	F	B	3.81 0.15	5.31 0.21	2.54 0.10	5.08±0.4 0.2±0.016	0.5±0.05 0.02±0.002
8121M	B	A	5.08 0.20	6.58 0.26	3.18 0.125	2.54±0.4 0.1±0.016	0.5±0.05 0.02±0.002
8121N	C	B	5.08 0.20	6.58 0.26	3.18 0.125	5.08±0.4 0.2±0.016	0.5±0.05 0.02±0.002
8121T		B	10.16 0.40	5.80 0.23	4.50 0.18	7.62±0.4 0.30±0.016	0.5±0.05 0.02±0.002
8131M	D	A	7.62 0.30	9.12 0.36	3.81/6.30 0.15/0.25	5.08±0.4 0.2±0.016	0.5±0.05 0.02±0.002
8131T		B	10.16 0.40	9.12 0.36	4.50 0.18	7.62±0.4 0.30±0.016	0.5±0.05 0.02±0.002
8141M		A	10.16 0.40	11.66 0.46	3.81 0.15	5.08±0.4 0.2±0.016	0.5±0.05 0.02±0.002
8151M		A	12.70 0.50	14.20 0.56	5.08/6.30 0.20/0.25	10.1±0.4 0.4±0.016	0.6±0.05 0.025±0.002
8161M		A	18.50 0.73	16.50 0.65	6.00/7.00 0.24/0.28	14.5±0.5 0.57±0.02	0.6±0.05 0.025±0.002
8165M		A	19.00 0.75	19.00 0.75	6.00 0.24	17.15±0.5 0.67±0.02	0.6±0.05 0.025±0.002
8171M		A	25.00 0.98	20.00 0.79	6.00/7.00 0.24/0.28	20.5±0.5 0.81±0.02	0.6±0.05 0.025±0.002

Pattern A

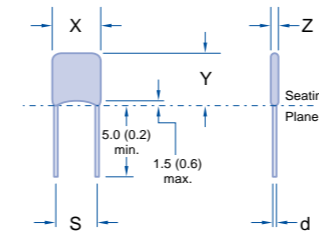

Pattern B

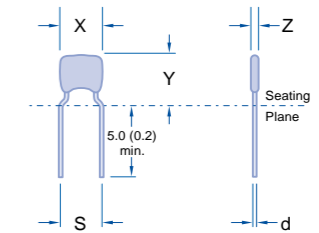

Note: Pattern A may be substituted with Pattern B at Syfer's discretion.

Marking information

All encapsulated capacitors are marked with:- Capacitance value, tolerance, rated d.c. voltage, dielectric, and where size permits the Syfer Technology 'S' logo.

Example: 1000pF ± 10% 50V 2X1 dielectric

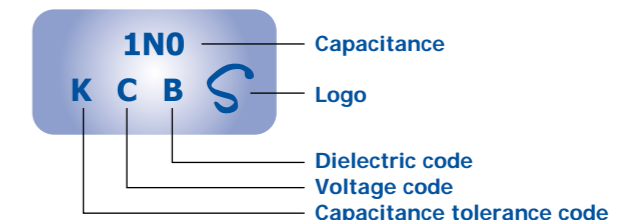

Ordering information - Radial Leaded capacitors

8111M	100	0102	J	C	□□□	□□□
Type No./ Size ref	Voltage d.c. (marking code)	Capacitance in picofarads (pF)	Capacitance tolerance	Dielectric Rel Release codes	Suffix	Suffix
8111M	050 = 50V (A)	First digit is 0. Second and third digits are significant figures of capacitance code.	<10pF D: ± 0.5pF F: ± 1.0pF	C = COG/NPO (1B/CG; CG/BP)	Used for specific customer requirements.	"C42" denotes RoHS compliant.
8111N	063 = 63V (D)	The fourth digit is number of zeros following.	>10pF J: ± 5% K: ± 10% M: ± 20%	X = X7R (2R1)		A31 or A97 denote non-RoHS tin/lead wires.
8121M	100 = 100V (B)	Example: 8P20 = 8.2pF	G: ± 2% (COG/NPO only).	To Special Order B = 2X1 (BX) R = 2C1 (BZ)		Suffix A97 for 8111 to 8141 & A31 for 8151, 8161, 8171.
8121N	200 = 200V (C)					
8121T	500 = 500V (Q)					
8131M	1K0 = 1kV (Z)					
8131T	1K2 = 1.2kV (O)					
8141M	1K5 = 1.5kV (T)					
8151M	2K0 = 2kV (M)					
8161M	2K5 = 2.5kV					
8165M	3K0 = 3kV (P)					
8171M	4K0 = 4kV (S)					
	5K0 = 5kV (2)					
	6K0 = 6kV					

Notes: The voltage code may be replaced with the complete voltage (e.g. 1500V = 1K5V) at Syfer's discretion. Marking may be over both sides of the component as necessary.

Capacitance	8111M / 8111N		8121M / 8121N		8121T		8131M		8131T		Capacitance	Code
	COG/NPO	X7R	COG/NPO	X7R	COG/NPO	X7R	COG/NPO	X7R	COG/NPO	X7R		
4.7pF	50/63V		50/63V		50/63V		50/63V		50/63V		4.7pF	4p7
5.6	100V		100V		100V		100V		100V		5.6	5p6
6.8	200/250V		200/250V		200/250V		200/250V		200/250V		6.8	6p8
8.2	50/63V		50/63V		50/63V		50/63V		50/63V		8.2	8p2
10pF	100V		100V		100V		100V		100V		10pF	100
12	200/250V		200/250V		200/250V		200/250V		200/250V		12	120
15	50/63V		50/63V		50/63V		50/63V		50/63V		15	150
18	100V		100V		100V		100V		100V		18	180
22	200/250V		200/250V		200/250V		200/250V		200/250V		22	220
27	50/63V		50/63V		50/63V		50/63V		50/63V		27	270
33	100V		100V		100V		100V		100V		33	330
39	200/250V		200/250V		200/250V		200/250V		200/250V		39	390
47	50/63V		50/63V		50/63V		50/63V		50/63V		47	470
56	100V		100V		100V		100V		100V		56	560
68	200/250V		200/250V		200/250V		200/250V		200/250V		68	680
82	50/63V		50/63V		50/63V		50/63V		50/63V		82	820
100pF	100V		100V		100V		100V		100V		100pF	101
120	200/250V		200/250V		200/250V		200/250V		200/250V		120	121
150	50/63V		50/63V		50/63V		50/63V		50/63V		150	151
180	100V		100V		100V		100V		100V		180	181
220	200/250V		200/250V		200/250V		200/250V		200/250V		220	221
270	50/63V		50/63V		50/63V		50/63V		50/63V		270	271
330	100V		100V		100V		100V		100V		330	331
390	200/250V		200/250V		200/250V		200/250V		200/250V		390	391
470	50/63V		50/63V		50/63V		50/63V		50/63V		470	471
560	100V		100V		100V		100V		100V		560	561
680	200/250V		200/250V		200/250V		200/250V		200/250V		680	681
820	50/63V		50/63V		50/63V		50/63V		50/63V		820	821
1.0nF	100V		100V		100V		100V		100V		1.0nF	102
1.2	200/250V		200/250V		200/250V		200/250V		200/250V		1.2	122
1.5	50/63V		50/63V		50/63V		50/63V		50/63V		1.5	152
1.8	100V		100V		100V		100V		100V		1.8	182
2.2	200/250V		200/250V		200/250V		200/250V		200/250V		2.2	222
2.7	50/63V		50/63V		50/63V		50/63V		50/63V		2.7	272
3.3	100V		100V		100V		100V		100V		3.3	332
3.9	200/250V		200/250V		200/250V		200/250V		200/250V		3.9	392
4.7	50/63V		50/63V		50/63V		50/63V		50/63V		4.7	472
5.6	100V		100V		100V		100V		100V		5.6	562
6.8	200/250V		200/250V		200/250V		200/250V		200/250V		6.8	682
8.2	50/63V		50/63V		50/63V		50/63V		50/63V		8.2	822
10nF	100V		100V		100V		100V		100V		10nF	103
12	200/250V		200/250V		200/250V		200/250V		200/250V		12	123
15	50/63V		50/63V		50/63V		50/63V		50/63V		15	153
18	100V		100V		100V		100V		100V		18	183
22	200/250V		200/250V		200/250V		200/250V		200/250V		22	223
27	50/63V		50/63V		50/63V		50/63V		50/63V		27	273
33	100V		100V		100V		100V		100V		33	333
39	200/250V		200/250V		200/250V		200/250V		200/250V		39	393
47	50/63V		50/63V		50/63V		50/63V		50/63V		47	473
56	100V		100V		100V		100V		100V		56	563
68	200/250V		200/250V		200/250V		200/250V		200/250V		68	683
82	50/63V		50/63V		50/63V		50/63V		50/63V		82	823
100nF	100V		100V		100V		100V		100V		100nF	104
120	200/250V		200/250V		200/250V		200/250V		200/250V		120	124
150	50/63V		50/63V		50/63V		50/63V		50/63V		150	154
180	100V		100V		100V		100V		100V		180	184
220	200/250V		200/250V		200/250V		200/250V		200/250V		220	224
270	50/63V		50/63V		50/63V		50/63V		50/63V		270	274
330	100V		100V		100V		100V		100V		330	334
390	200/250V		200/250V		200/250V		200/250V		200/250V		390	394
470	50/63V		50/63V		50/63V		50/63V		50/63V		470	474
560	100V		100V		100V		100V		100V		560	564
680	200/250V		200/250V		200/250V		200/250V		200/250V		680	684
820	50/63V		50/63V		50/63V		50/63V		50/63V		820	824
1.0µF	100V		100V		100V		100V		100V		1.0µF	105
1.2	200/250V		200/250V		200/250V		200/250V		200/250V		1.2	125
1.5	50/63V		50/63V		50/63V		50/63V		50/63V		1.5	155
1.8	100V		100V		100V		100V		100V		1.8	185
2.2	200/250V		200/250V		200/250V		200/250V		200/250V		2.2	225
2.7	50/63V		50/63V		50/63V		50/63V		50/63V		2.7	275
3.3	100V		100V		100V		100V		100V		3.3	335
3.9	200/250V		200/250V		200/250V		200/250V		200/250V		3.9	395
4.7	50/63V		50/63V		50/63V		50/63V		50/63V		4.7	475
5.6	100V		100V		100V		100V		100V		5.6	565
6.8	200/250V		200/250V		200/250V		200/250V		200/250V		6.8	685
8.2	50/63V		50/63V		50/63V		50/63V		50/63V		8.2	825
10µF	100V		100V		100V		100V		100V		10µF	106
12	200/250V		200/250V		200/250V		200/250V		200/250V		12	126
15µF	50/63V		50/63V		50/63V		50/63V		50/63V		15µF	156

Capacitance	Code	8141M		8151M		8161M		8171M		Capacitance	Code
		COG/NPO	X7R	COG/NPO	X7R	COG/NPO	X7R	COG/NPO	X7R		
4.7pF	4p7									4.7pF	4p7
5.6	5p6									5.6	5p6
6.8	6p8									6.8	6p8
8.2	8p2									8.2	8p2
10pF	100									10pF	100
12	120									12	120
15	150									15	150
18	180									18	180
22	220									22	220
27	270									27	270
33	330									33	330
39	390									39	390
47	470									47	470
56	560									56	560
68	680									68	680
82	820									82	820
100pF	101									100pF	101
120	121									120	121
150	151									150	151
180	181									180	181
220	221									220	221
270	271									270	271
330	331									330	331
390	391									390	391
470	471									470	471
560	561									560	561
680	681									680	681
820	821									820	821
1.0nF	102									1.0nF	102
1.2	122									1.2	122
1.5	152									1.5	152
1.8	182									1.8	182
2.2	222									2.2	222
2.7	272									2.7	272
3.3	332									3.3	332
3.9	392									3.9	392
4.7	472									4.7	472
5.6	562									5.6	562
6.8	682									6.8	682
8.2	822									8.2	822
10nF	103									10nF	103
12	123									12	123
15	153									15	153
18	183									18	183
22	223									22	223
27	273									27	273
33	333									33	333
39	393									39	393
47	473									47	473
56	563									56	563
68	683									68	683
82	823									82	823
100nF	104									100nF	104
120	124									120	124
150	154									150	154
180	184									180	184
220	224									220	224
270	274									270	274
330	334									330	334
390	394									390	394
470	474									470	474
560	564									560	564
680	684									680	684
820	824									820	824
1.0µF	105									1.0µF	105
1.2	125									1.2	125
1.5	155									1.5	155
1.8	185									1.8	185
2.2	225									2.2	225
2.7	275									2.7	275
3.3	335									3.3	335
3.9	395									3.9	395
4.7	475									4.7	475
5.6	565									5.6	565
6.8	685									6.8	685
8.2	825									8.2	825
10µF	106									10µF	106
12	126									12	126
15µF	156									15µF	156

Note: The highlighted parts are defined as 'dual-use' under export control legislation and as such are subject to export licence restrictions. Please refer to page 9 for further details.

Cropped leads

Cropped leads between 4.0 (0.157) and 30.0 (1.18) are available to special order. Some of the preferred codes are listed below, together with the appropriate suffix code. Dimensions as for standard product except as specified.

Suffix code - AE3 All radial ranges	Suffix code - AE4 All radial ranges	Suffix code - AD7 All radial ranges	Suffix code - AD5 All radial ranges
Lead length (L) 6 ± 1 (0.236 ± 0.04) from seating plane	Lead length (L) 4 ± 1 (0.162 ± 0.04) from seating plane	Lead length (L) 5 ± 1 (0.2 ± 0.04) from seating plane	Lead length (L) 10 ± 1 (0.4 ± 0.04) from seating plane

Snap in leads

Various forms of snap in leads (preformed) are available to special order, some of the preferred suffix codes are listed below. Dimensions as for standard product except as specified.

Suffix code - AD1

For PCB holes 0.9mm diameter
Types 8121N and 8131M

Dimensions
Y = 8121N 8 (0.315) Max
8131M 10 (0.394) Max
L = Min: 2.75 (0.108)
Max: 3.50 (0.138)

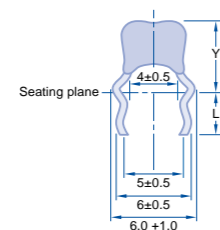

Suffix code - AD2

For PCB holes 1.2mm diameter
Types 8131M

Dimensions
Y = 10 (0.294) Max
L = Min: 2.75 (0.108)
Max: 3.50 (0.138)

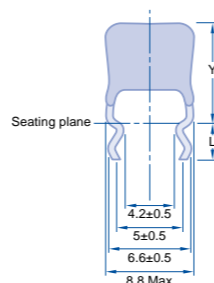

Suffix code - AD3

For PCB holes 1.2mm diameter
Types 8121N

Dimensions
Y = 8 (0.315) Max
L = Min: 2.75 (0.108)
Max: 3.50 (0.138)

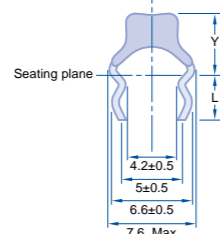

Dimensions mm (inches)

Bandoliered suffix codes

Dipped radial leaded with 2.54 and 5.08mm lead spacing can be supplied bandoliered on reels or in ammo boxes to special order. Some of the preferred suffix codes for bandoliered products are given below.

For bandoliered products the minimum order quantity, pieces, is specified in the tables below, larger orders must be in multiples of this quantity.

Dipped – straight and formed leads

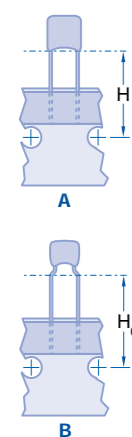

Product code	Lead style	Diagram	H	H ₀	Suffix code		
					Reel	AMMO pack	
8111M	Straight 2.54 crs	A	19±1	-	2500pcs C01	1000pcs C02	2000pcs C11
8111M	Straight 2.54 crs	A	16±0.5	-	C30	C31	C32
8111N	Formed 5.08 crs	B	-	16±0.5	C01	C02	C11
8121M	Straight 2.54 crs	A	19±1	-	C01	C02	C11
8121M	Straight 2.54 crs	A	16±0.5	-	C30	C31	C32
8121N	Formed 5.08 crs	B	-	16±0.5	C01	C02	C11
8131M	Straight 5.08 crs	A	19±1	-	C01	C02	C11
8131M	Straight 5.08 crs	A	16±0.5	-	C30	C31	C32

8121T and 8131T available in bulk packaging only.

Dipped – stand-off lead form

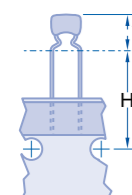

This style has been developed to provide a meniscus-free seating plane with a stress relieving form for auto-insertion.

Product code	Lead style	Y max	H ₀	2500pcs	1000pcs	2000pcs
8111N	Formed 5.08 crs	7.5	16±0.5	C12	C23	C22
8111N	Formed 5.08 crs	7.5	19±1	C13	C25	C24
8121N	Formed 5.08 crs	8.5	16±0.5	C12	C23	C22
8121N	Formed 5.08 crs	8.5	19±1	C13	C25	C24

A maximum of 3 consecutive components may be missing from the bandolier, followed by at least 6 filled positions. Components missing from the bandolier are included in the total quantity, whereby the number of missing components may not exceed 0.25% of this total per packing module. At the beginning and end of a reel the bandolier will exhibit at least 10 blank positions.

Minimum pull strength of product from tape = 5N.

Each reel/carton is provided with a label showing the: Manufacturer, product style, batch identification, quantity and date code.

Labelling with bar codes (code 39) is available on request.

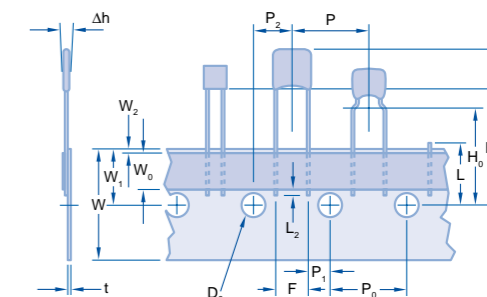

In accordance with IEC 60286 part 2.

Dimensions mm (inches)

Description	Symbol	2.5mm lead space	5mm lead space	Tolerance
Lead wire diameter	d	0.5 (0.02) 0.6 (0.025)	0.5 (0.02) 0.6 (0.025)	±0.05 (0.002)
Component pitch	P	12.7 (0.5)	12.7 (0.5)	1.00 (0.04)
Feed hole pitch	P ₀	12.7 (0.5)	12.7 (0.5)	±0.30 (0.01)
Feed hole centre to lead	P ₁	5.08 (0.2)	3.81 (0.15)	±0.70 (0.03)
Feed hole centre to component	P ₂	6.35 (0.25)	6.35 (0.25)	±0.70 (0.03)
Lead spacing	F	2.54 (0.10)	5.08 (0.20)	+0.6 (0.02) -0.1 (0.004)
Component alignment	Δh	0	0	±2.00(0.08)
Tape width	W	18.0 (0.70)	18.0 (0.70)	+1.00 (0.04) -0.50 (0.02)
Hold down tape width	W ₀	6.0 (0.23)	6.0 (0.23)	±0.30 (0.01)
Hole position	W ₁	9.0 (0.35)	9.0 (0.35)	±0.50 (0.02)
Hold down tape position	W ₂	0.50 (0.02)	0.50 (0.02)	Max
Height to seating plane from tape centre (straight leads) (2)	H	16 (0.63) to 20 (0.79)	16 (0.63) to 20 (0.79)	As required
Height to seating plane from tape centre (formed leads) (2)	H ₀	16 (0.63) to 20 (0.79)	16 (0.63) to 20 (0.79)	As required
Height to top of component from tape centre	H ₁	32.2 (1.26)	32.2 (1.26)	Max
Feed hole diameter	D ₀	4.0 (0.16)	4.0 (0.16)	±0.20 (0.008)
Carrier tape plus adhesive tape thickness	t	0.7 (0.03)	0.7 (0.03)	±0.20 (0.008)
Carrier tape thickness	-	0.5 (0.02)	0.5 (0.02)	±0.10 (0.004)
Cut out component snipped lead length from tape centre	L	11.0 (0.43)	11.0 (0.43)	Max
Lead wire protrusion from hold down	L ₂	2.0 (0.08)	2.0 (0.08)	Max

Bandoliered reels

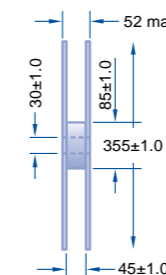
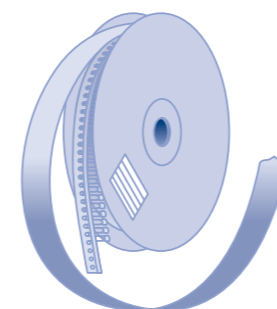

Bandoliered ammo packing

2 carton sizes

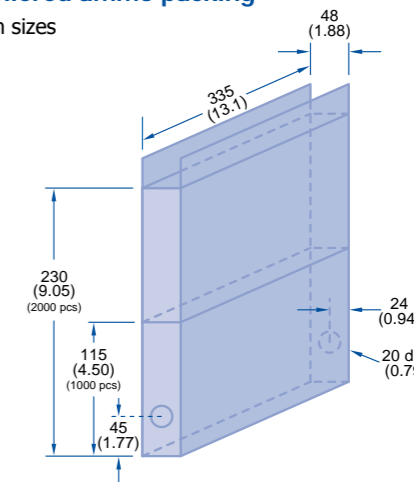

The adhesive tape faces outwards. The dispensing direction is as shown. For the protection of the components a paper inlay is inserted between the windings of the bandolier. At the end of the bandolier this paper inlay continues for at least a further two rotations.

BSC Filters Limited
Dover House, 10-11 Sterling Park, Amy Johnson Way,
Clifton Moor, York YO30 4WU UK

Phone: +44 1904 438438
Fax: +44 1904 438123
Email: sales@bscfilters.com



Dielectric Laboratories, Inc
2777 Route 20 East, Cazenovia, NY 13035 USA

Phone: +1 315 655 8710
Fax: +1 315 655 0445
Email: sales@dilabs.com



Dow-Key Microwave
4822 McGrath Street, Ventura, CA 93003 USA

Phone: +1 805 650 0260
Fax: +1 805 650 1734
Email: askdk@dowkey.com



K&L Microwave
2250 Northwood Drive, Salisbury, MD 21801 USA

Phone: +1 410 749 2424
Fax: +1 443 260 2268
Email: sales@klmicrowave.com



Novacap
25111 Anza Drive, Valencia, CA 91355 USA

Phone: +1 661 295 5920
Fax: +1 661 295 5928
Email: info@novacap.com



Pole/Zero Corporation
5558 Union Centre Drive, West Chester, OH 45069 USA

Phone: +1 513 870 9060
Fax: +1 513 870 9064
Email: support@polezero.com



Syfer Technology Limited
Old Stoke Road, Arminghall, Norwich, NR14 8SQ UK

Phone: +44 1603 723300
Fax: +44 1603 723301
Email: sales@syfer.co.uk



Voltronics Corporation
2250 Northwood Drive, Salisbury, MD 21801 USA

Phone: +1 410 749 2424
Fax: +1 443 260 2263
Email: info@voltronicscorp.com



www.dovercmp.com

Ceramic & Microwave Products (CMP) designs, manufactures and sells special electronic components and systems, including high-performance filters, switches, capacitors and EMI and cosite signal interference solutions. Our products are used in military, space, telecom infrastructure, medical and industrial applications where function and reliability are crucial.