

FEATURES

- Conversion loss: 9 dB typical at 3 GHz to 9 GHz**
- Local oscillator (LO) to radio frequency (RF) isolation:
43 dB typical at 3 GHz to 9 GHz**
- RF to intermediate frequency (IF) isolation: 26 dB typical at
3 GHz to 9 GHz**
- Input third-order intercept (IP3): 24 dBm typical at
3 GHz to 9 GHz**
- Input 1 dB compression point (P1dB): 17 dBm typical at
3 GHz to 9 GHz**
- Input second-order intercept (IP2): 67 dBm typical at
3 GHz to 9 GHz**
- Passive double-balanced topology**
- Wide IF frequency range: dc to 4 GHz**
- 12-terminal, ceramic, leadless chip carrier (LCC) package**

APPLICATIONS

- Microwave radio**
- Industrial, scientific, and medical (ISM) band and ultrawide
band (UWB) radio**
- Test equipment and sensors**
- Military end use**

GENERAL DESCRIPTION

The **HMC787A** is a general-purpose, double balanced mixer in a 12-terminal, RoHS compliant, ceramic leadless chip carrier (LCC) package that can be used as an upconverter or down-converter from 3 GHz to 10 GHz. This mixer is fabricated in a gallium arsenide (GaAs), metal semiconductor field effect transistor (MESFET) process and requires no external components

FUNCTIONAL BLOCK DIAGRAM

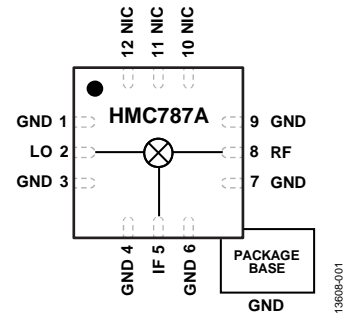

Figure 1.

or matching circuitry. The **HMC787A** provides excellent local oscillator (LO) to radio frequency (RF) and LO to intermediate frequency (IF) isolation due to optimized balun structures and operates with a LO drive level of 17 dBm. The ceramic LCC package eliminates the need for wire bonding and is compatible with high volume, surface-mount manufacturing techniques.

HMC787A* Product Page Quick Links

Last Content Update: 11/04/2016

[Comparable Parts](#)

View a parametric search of comparable parts

[Evaluation Kits](#)

- [HMC787A Evaluation Board](#)

[Documentation](#)

Data Sheet

- [HMC787A: GaAs, MMIC, Fundamental Mixer, 3 GHz to 10 GHz Data Sheet](#)

[Design Resources](#)

- [HMC787A Material Declaration](#)
- [PCN-PDN Information](#)
- [Quality And Reliability](#)
- [Symbols and Footprints](#)

[Discussions](#)

View all HMC787A EngineerZone Discussions

[Sample and Buy](#)

Visit the product page to see pricing options

[Technical Support](#)

Submit a technical question or find your regional support number

TABLE OF CONTENTS

| | | | |
|--|---|--|----|
| Features | 1 | Downconverter Performance | 6 |
| Applications..... | 1 | Upconverter Performance..... | 10 |
| Functional Block Diagram | 1 | Isolation and Return Loss Performance..... | 12 |
| General Description | 1 | Spurious and Harmonics Performance | 14 |
| Revision History | 2 | Theory of Operation | 15 |
| Specifications..... | 3 | Applications Information | 16 |
| Absolute Maximum Ratings..... | 4 | Typical Application Circuit..... | 16 |
| Thermal Resistance | 4 | Evaluation PCB Information | 16 |
| ESD Caution..... | 4 | Outline Dimensions | 17 |
| Pin Configuration and Function Descriptions..... | 5 | Ordering Guide | 17 |
| Interface Schematics..... | 5 | | |
| Typical Performance Characteristics | 6 | | |

REVISION HISTORY

10/2016—Revision 0: Initial Version

SPECIFICATIONS

T_A = 25°C, IF = 100 MHz, LO = 17 dBm, and all measurements performed as downconverter, unless otherwise noted.

Table 1.

| Parameter | Min | Typ | Max | Unit |
|-------------------------------------|-----|-----|-----|------|
| FREQUENCY RANGE | | | | |
| RF | 3 | | 10 | GHz |
| LO | 3 | | 10 | GHz |
| IF | DC | | 4 | GHz |
| LO DRIVE LEVEL | | | | |
| | | 17 | | dBm |
| PERFORMANCE AT RF = 3 GHz to 9 GHz | | | | |
| Conversion Loss | | 9 | 11 | dB |
| Single Sideband (SSB) Noise Figure | | 9 | | dB |
| Input Third-Order Intercept (IP3) | 15 | 24 | | dBm |
| Input 1 dB Compression Point (P1dB) | | 17 | | dBm |
| Input Second-Order Intercept (IP2) | | 67 | | dB |
| RF to IF Isolation | 15 | 26 | | dB |
| LO to RF Isolation | | 48 | | dB |
| LO to IF Isolation | 35 | 43 | | dB |
| PERFORMANCE AT RF = 9 GHz to 10 GHz | | | | |
| Conversion Loss | | 9 | 11 | dB |
| SSB Noise Figure | | 9 | | dB |
| Input IP3 | 15 | 24 | | dBm |
| Input P1dB | | 15 | | dBm |
| Input IP2 | | 66 | | dB |
| RF to IF Isolation | 15 | 26 | | dB |
| LO to RF Isolation | | 47 | | dB |
| LO to IF Isolation | 25 | 42 | | dB |

ABSOLUTE MAXIMUM RATINGS

Table 2.

| Parameter | Rating |
|--|---|
| RF Input Power | 28 dBm |
| LO Input Power | 28 dBm |
| IF Input Power | 28 dBm |
| IF Source and Sink Current | 12 mA |
| Continuous Power Dissipation, P_{DISS} ($T_A = 85^\circ\text{C}$, Derate 11.6 mW/ $^\circ\text{C}$ Above 85°C) | 1044 mW |
| Maximum Junction Temperature | 175°C |
| Maximum Peak Reflow Temperature (MSL3) ¹ | 260°C |
| Operating Temperature Range | -40°C to $+85^\circ\text{C}$ |
| Storage Temperature Range | -55°C to $+125^\circ\text{C}$ |
| Electrostatic Discharge (ESD) Sensitivity | |
| Human Body Model (HBM) | 1500 V (Class 1C) |
| Field Induced Charged Device Model (FICDM) | 1000 V (Class C5) |

¹ See the Ordering Guide section.

Stresses at or above those listed under Absolute Maximum Ratings may cause permanent damage to the product. This is a stress rating only; functional operation of the product at these or any other conditions above those indicated in the operational section of this specification is not implied. Operation beyond the maximum operating conditions for extended periods may affect product reliability.

THERMAL RESISTANCE

Thermal performance is directly linked to printed circuit board (PCB) design and operating environment. Careful attention to PCB thermal design is required.

Table 3. Thermal Resistance

| Package Type | θ_{JA} | θ_{JC} | Unit |
|---------------------|---------------|---------------|---------------------------|
| E-12-1 ¹ | 120 | 86 | $^\circ\text{C}/\text{W}$ |

¹ See JEDEC standard JESD51-2 for additional information on optimizing the thermal impedance (PCB with 3×3 vias).

ESD CAUTION



ESD (electrostatic discharge) sensitive device.

Charged devices and circuit boards can discharge without detection. Although this product features patented or proprietary protection circuitry, damage may occur on devices subjected to high energy ESD. Therefore, proper ESD precautions should be taken to avoid performance degradation or loss of functionality.

PIN CONFIGURATION AND FUNCTION DESCRIPTIONS

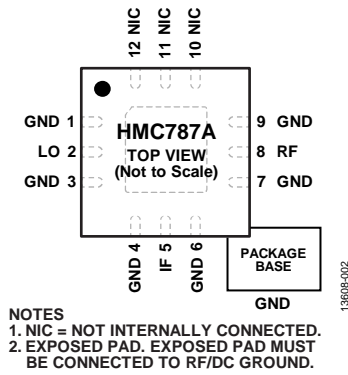

Figure 2. Pin Configuration

Table 4. Pin Function Descriptions

| Pin No. | Mnemonic | Description |
|------------------|-------------|---|
| 1, 3, 4, 6, 7, 9 | GND | Ground. Connect the package bottom to RF/dc ground. See Figure 3 for the GND interface schematic. |
| 2 | LO | Local Oscillator. This pin is dc-coupled and matched to 50 Ω. See Figure 4 for the LO interface schematic. |
| 5 | IF | Intermediate Frequency. This pin is dc-coupled. For applications not requiring operation to dc, externally block this pin using a series capacitor whose value is chosen to pass the necessary IF frequency range. For operation to dc, this pin must not source or sink more than 12 mA of current or device nonfunction and possible device failure results. See for Figure 5 the IF interface schematic. |
| 8 | RF | Radio Frequency. This pin is dc-coupled and matched to 50 Ω. See Figure 6 for the RF interface schematic. |
| 10 to 12 | NIC EPAD | Not Internally Connected. Exposed Pad. Exposed pad must be connected to RF/dc ground. |

INTERFACE SCHEMATICS



Figure 3. GND Interface Schematic

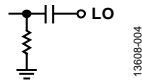

Figure 4. LO Interface Schematic

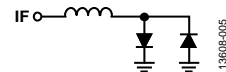

Figure 5. IF Interface Schematic

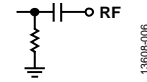

Figure 6. RF Interface Schematic

TYPICAL PERFORMANCE CHARACTERISTICS

DOWNCONVERTER PERFORMANCE

Data taken as downconverter, lower sideband (high-side LO), $T_A = 25^\circ\text{C}$, and LO drive level = 17 dBm, unless otherwise noted. Measurements taken with LO amplifier in line with lab bench LO source.

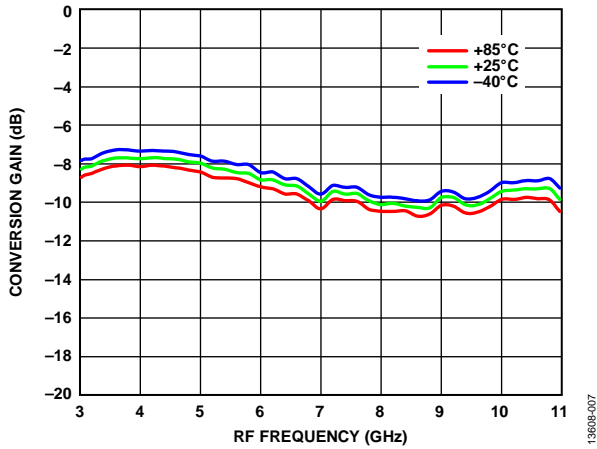

Figure 7. Conversion Gain vs. RF Frequency for Various Temperatures, $IF = 100\text{ MHz}$, LO Power = 17 dBm

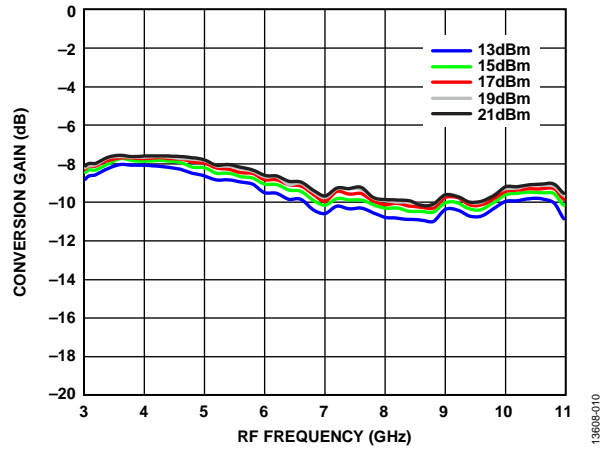

Figure 10. Conversion Gain vs. RF Frequency for Various LO Powers, $IF = 100\text{ MHz}$, Temperature = 25°C

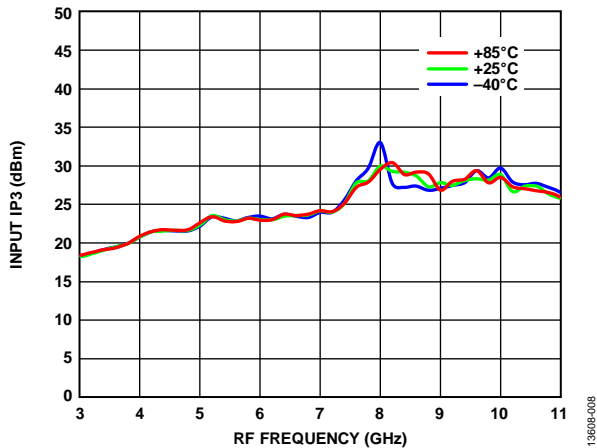

Figure 8. Input Third-Order Intercept (IP3) vs. RF Frequency for Various Temperatures, $IF = 100\text{ MHz}$, LO Power = 17 dBm

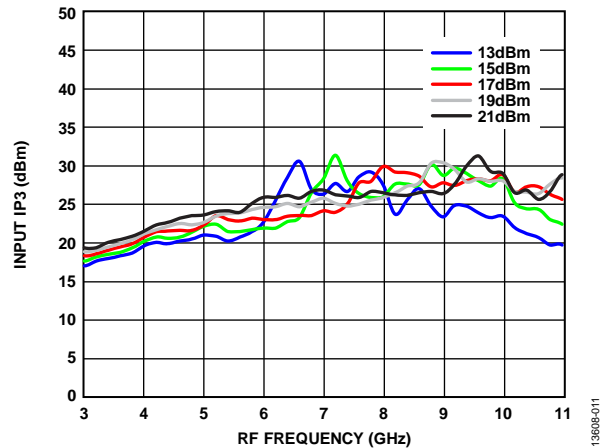

Figure 11. Input Third-Order Intercept (IP3) vs. RF Frequency for Various LO Powers, $IF = 100\text{ MHz}$, Temperature = 25°C

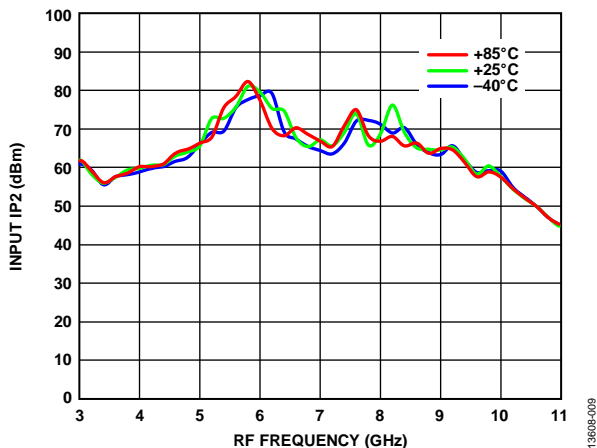

Figure 9. Input Second-Order Intercept (IP2) vs. RF Frequency for Various Temperatures, $IF = 100\text{ MHz}$, LO Power = 17 dBm

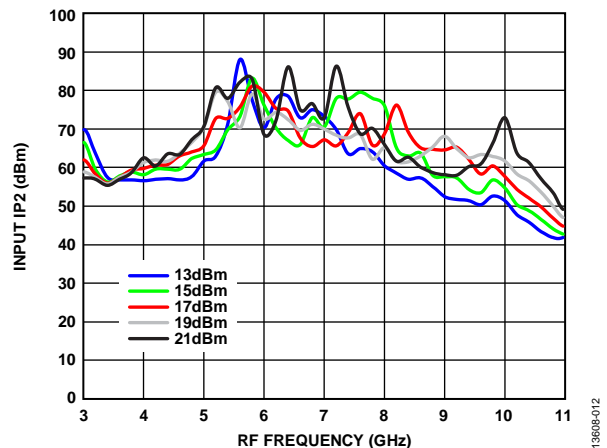

Figure 12. Input Second-Order Intercept (IP2) vs. RF Frequency for Various LO Powers, $IF = 100\text{ MHz}$, Temperature = 25°C

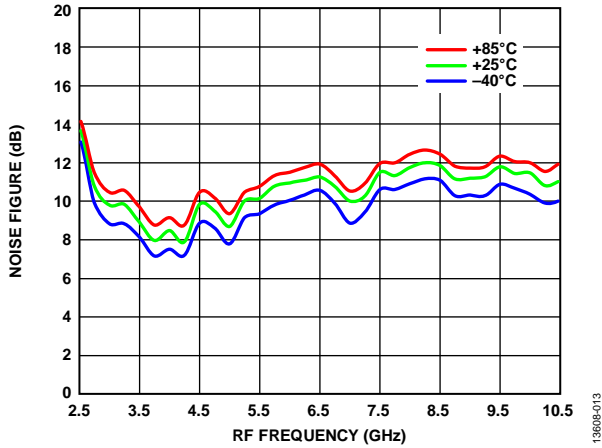

Figure 13. Single Sidband Noise Figure vs. RF Frequency for Various Temperatures, IF = 100 MHz, LO Power = 17 dBm

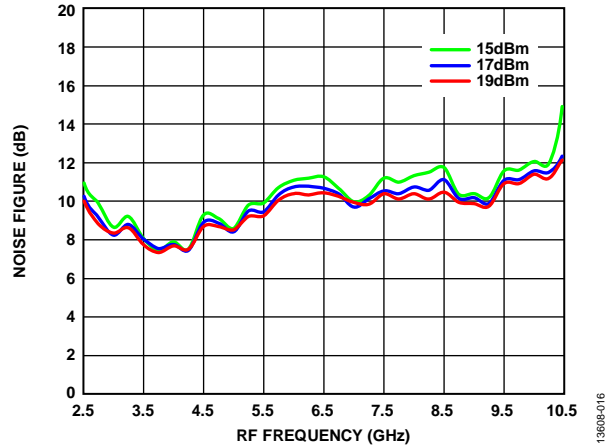

Figure 16. Single Sidband Noise Figure vs. RF Frequency for Various LO Powers, IF = 100 MHz, Temperature = 25°C

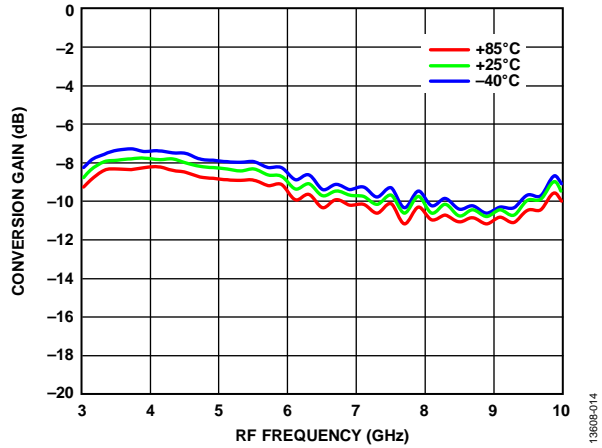

Figure 14. Conversion Gain vs. RF Frequency for Various Temperatures, IF = 1100 MHz, LO Power = 17 dBm

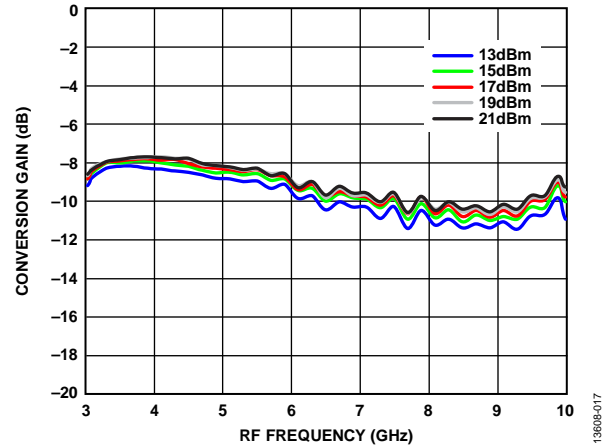

Figure 17. Conversion Gain vs. RF Frequency for Various LO Powers, IF = 1100 MHz, Temperature = 25°C

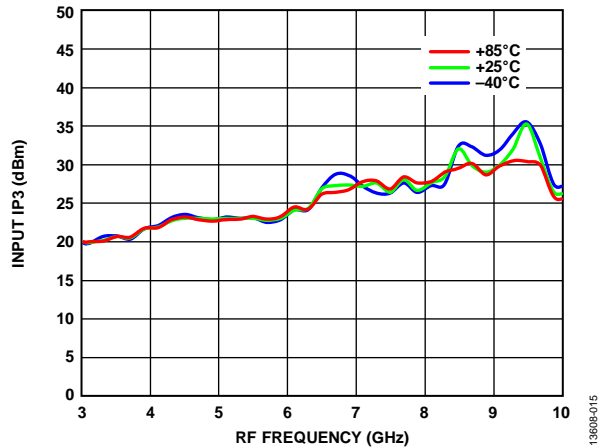

Figure 15. Input Third-Order Intercept (IP3) vs. RF Frequency for Various Temperatures, IF = 1100 MHz, LO Power = 17 dBm

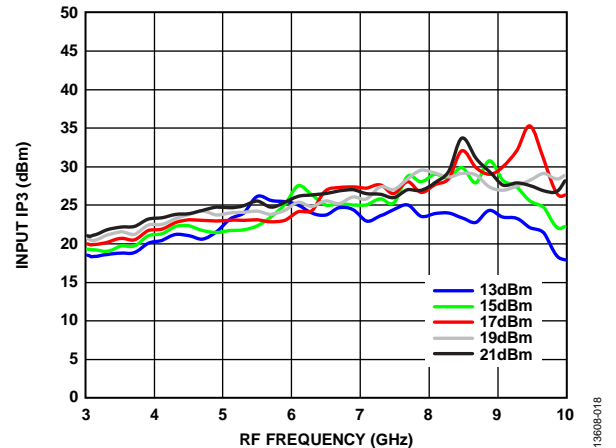

Figure 18. Input Third-Order Intercept (IP3) vs. RF Frequency for Various LO Powers, IF = 1100 MHz, Temperature = 25°C

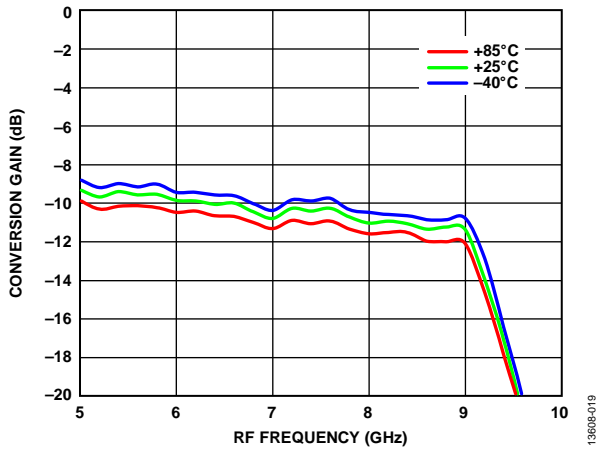

Figure 19. Conversion Gain vs. RF Frequency for Various Temperatures, IF = 3000 MHz, LO Power = 17 dBm

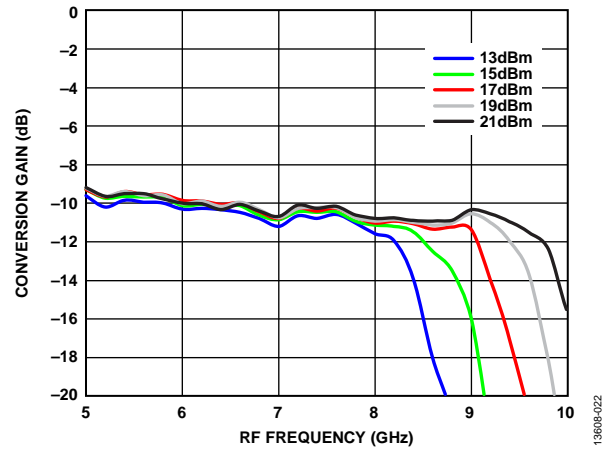

Figure 22. Conversion Gain vs. RF Frequency for Various LO Powers, IF = 3000 MHz, Temperature = 25°C

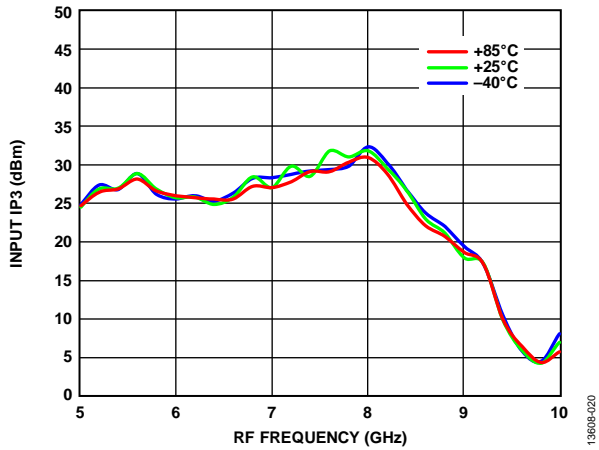

Figure 20. Input Third-Order Intercept (IP3) vs. RF Frequency for Various Temperatures, IF = 3000 MHz, LO Power = 17 dBm

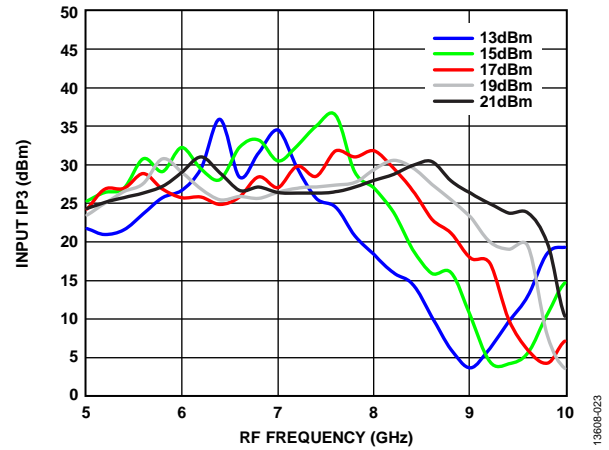

Figure 23. Input Third-Order Intercept (IP3) vs. RF Frequency for Various LO Powers, IF = 3000 MHz, Temperature = 25°C

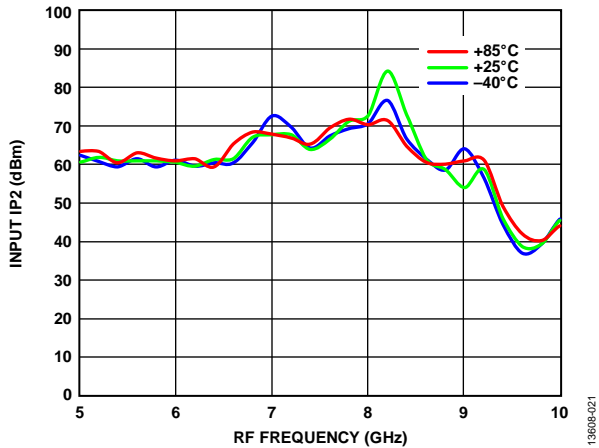

Figure 21. Input Second-Order Intercept (IP2) vs. RF Frequency at Various Temperatures, IF = 3000 MHz, LO Power = 17 dBm

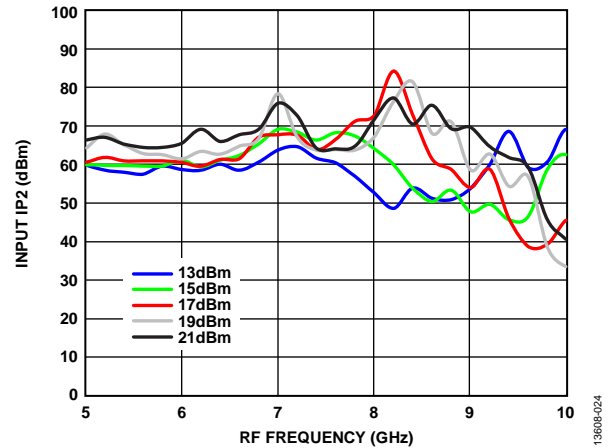

Figure 24. Input Second-Order Intercept (IP2) vs. RF Frequency for Various LO Powers, IF = 3000 MHz, Temperature = 25°C

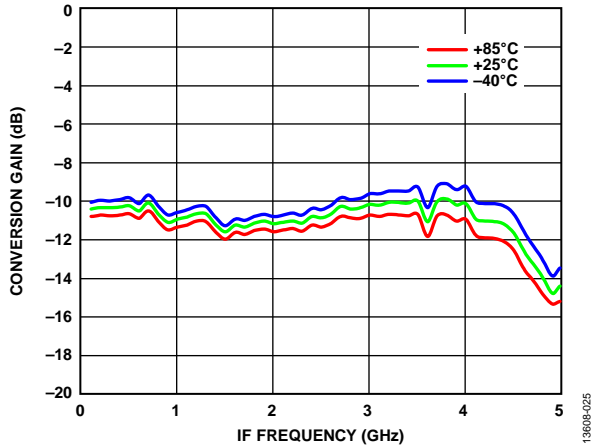

Figure 25. Conversion Gain vs. IF Frequency for Various Temperatures, LO = 9510 MHz, LO Power = 17 dBm

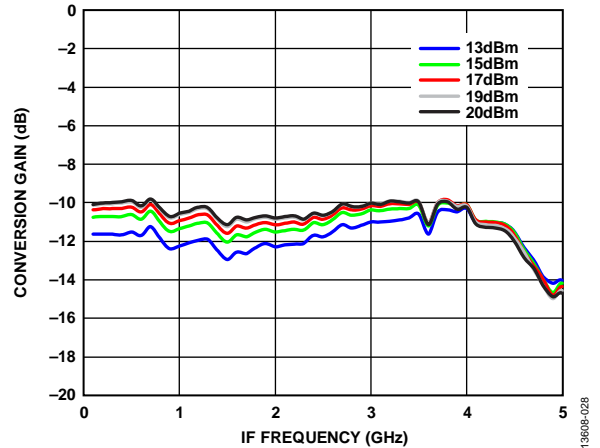

Figure 28. Conversion Gain vs. IF Frequency for Various LO Powers, LO = 9510 MHz, LO Power = 17 dBm

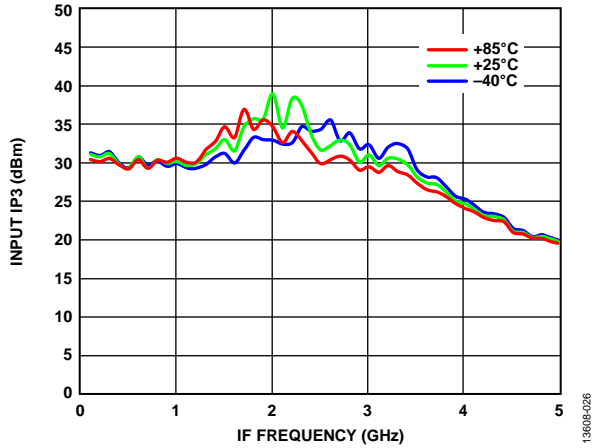

Figure 26. Input Third-Order Intercept (IP3) vs. IF Frequency for Various Temperatures, LO = 9510 MHz, LO Power = 17 dBm

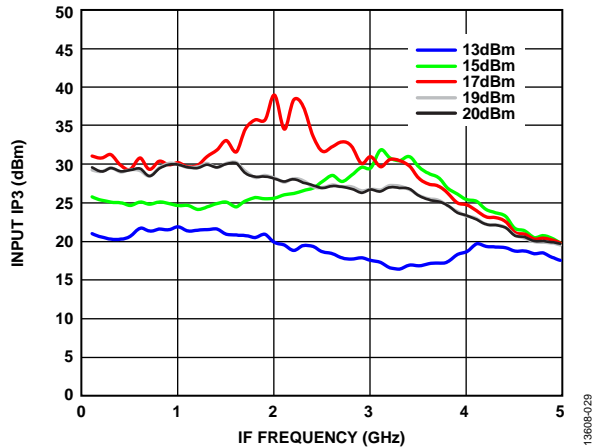

Figure 29. Input Third-Order Intercept (IP3) vs. IF Frequency for Various LO Powers, LO = 9510 MHz, LO Power = 17 dBm

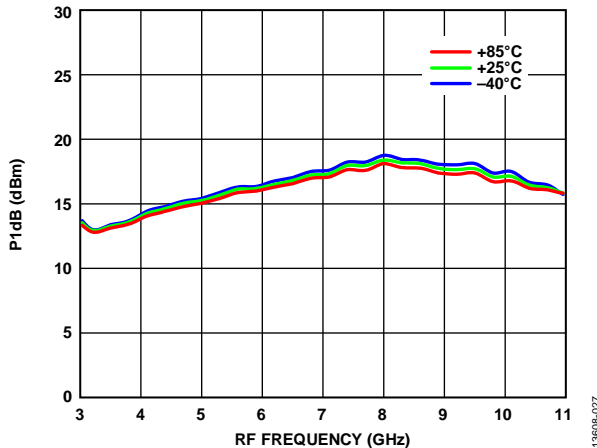

Figure 27. Input 1 dB Gain Compression (P1dB) vs. RF Frequency for Various Temperatures, IF = 100 MHz, LO = 17 dBm

UPCONVERTER PERFORMANCE

Data taken as upconverter, lower sideband (high-side LO), $T_A = 25^\circ\text{C}$, and LO drive level = 17 dBm, unless otherwise noted. Measurements taken with LO amplifier in line with lab bench LO source.

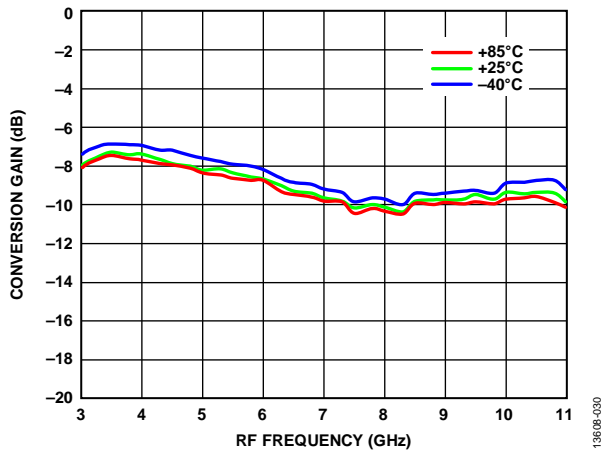

Figure 30. Conversion Gain vs. RF Frequency for Various Temperatures, IF = 100 MHz, LO Power = 17 dBm

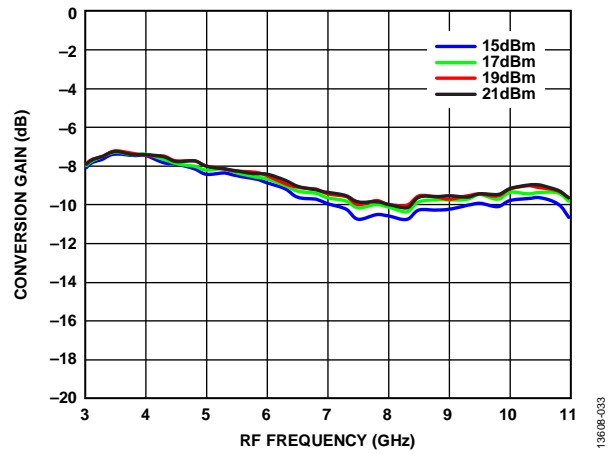

Figure 33. Conversion Gain vs. RF Frequency for Various LO Powers, IF = 100 MHz, Temperature = 25°C

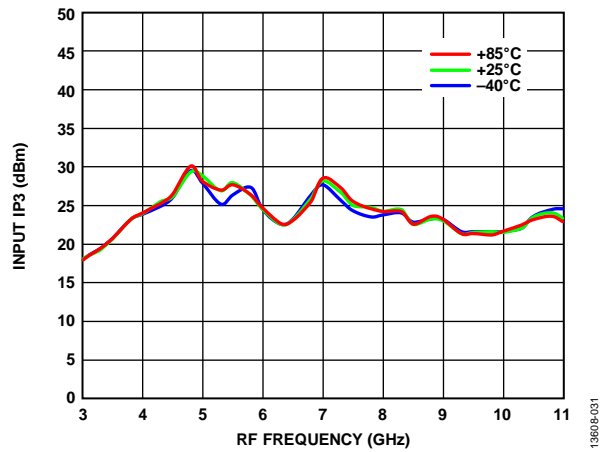

Figure 31. Input Third-Order Intercept (IP3) vs. RF Frequency for Various Temperatures, IF = 100 MHz, LO Power = 17 dBm

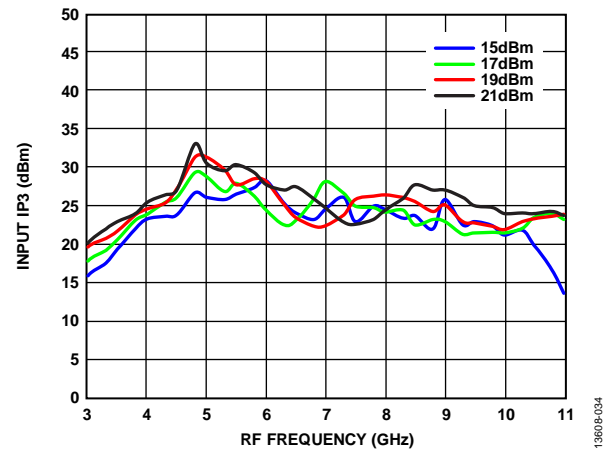

Figure 34. Input Third-Order Intercept (IP3) vs. RF Frequency for Various LO Powers, IF = 100 MHz, Temperature = 25°C

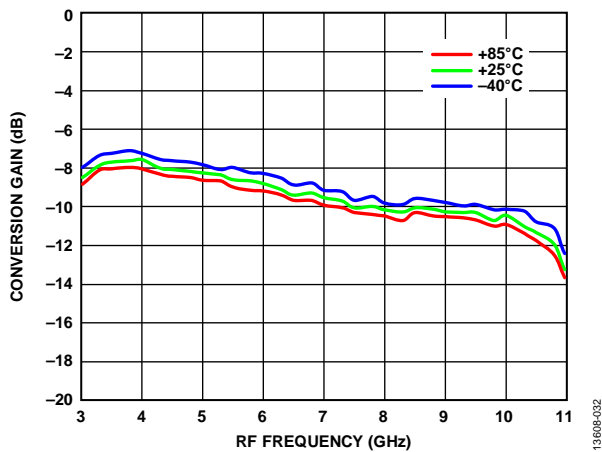

Figure 32. Conversion Gain vs. RF Frequency for Various Temperatures, IF = 1100 MHz, LO Power = 17 dBm

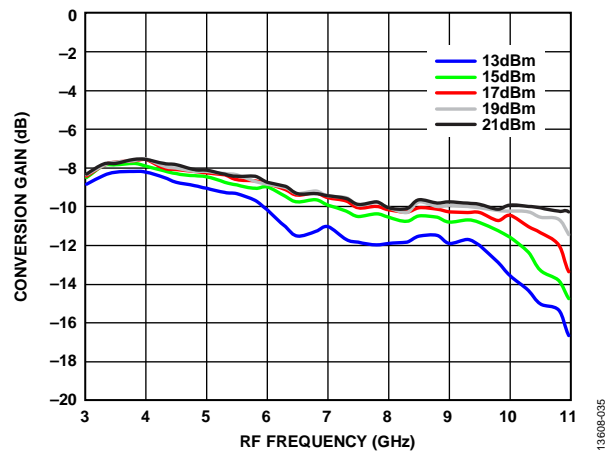

Figure 35. Conversion Gain vs. RF Frequency for Various LO Powers, IF = 1100 MHz, Temperature = 25°C

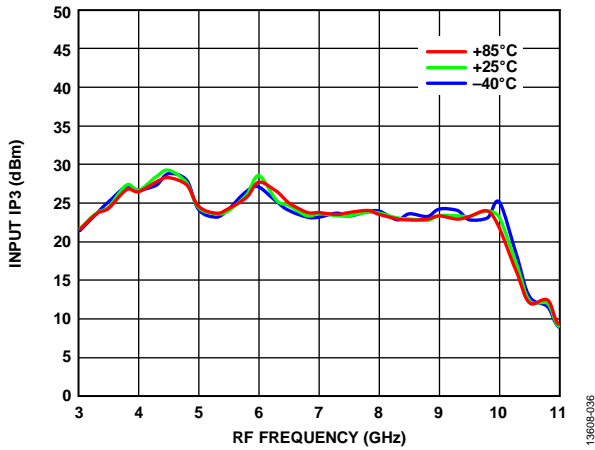

Figure 36. Input Third-Order Intercept (IP3) vs. RF Frequency for Various Temperatures at IF = 1100 MHz, LO Power = 17 dBm

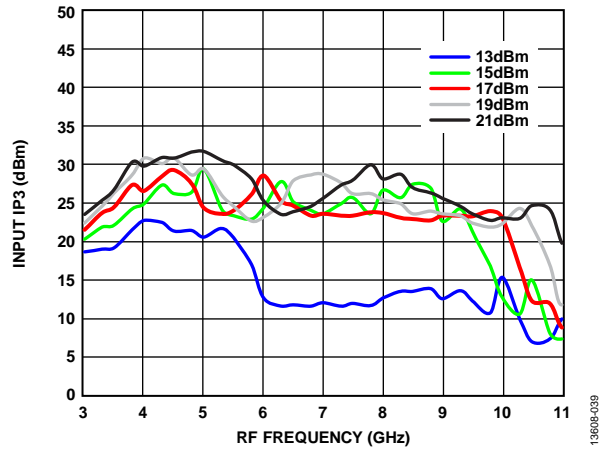

Figure 39. Input Third-Order Intercept (IP3) vs. RF Frequency for Various LO Powers at IF = 1100 MHz, Temperature = 25°C

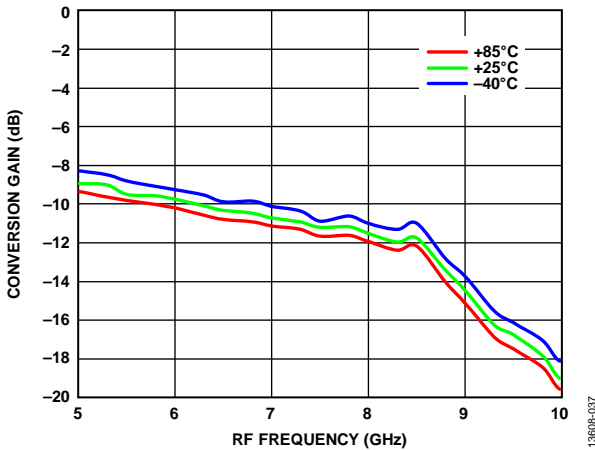

Figure 37. Conversion Gain vs. RF Frequency for Various Temperatures, IF = 3000 MHz, LO Power = 17 dBm

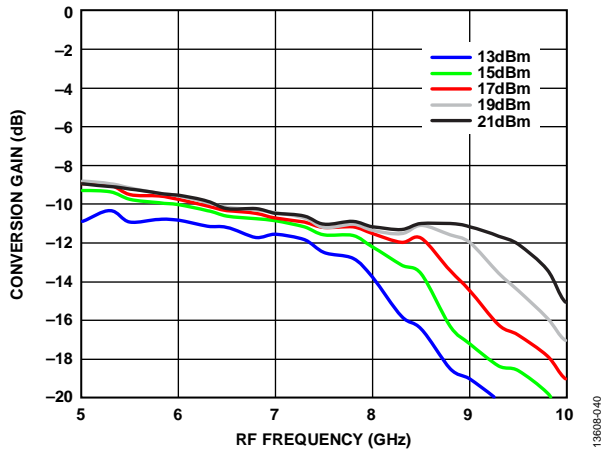

Figure 40. Conversion Gain vs. RF Frequency for Various LO Powers, IF = 3000 MHz, Temperature = 25°C

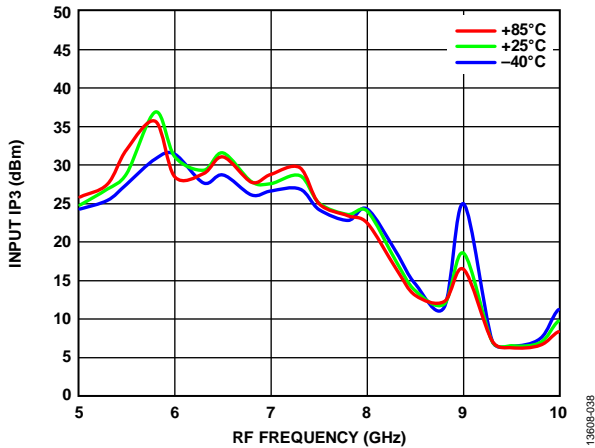

Figure 38. Input Third-Order Intercept (IP3) vs. RF Frequency for Various Temperatures at IF = 3000 MHz, LO Power = 17 dBm

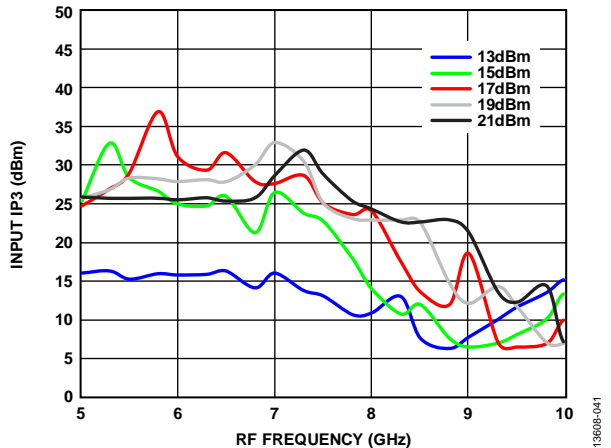

Figure 41. Input Third-Order Intercept (IP3) vs. RF Frequency for Various LO Powers at IF = 3000 MHz, Temperature = 25°C

ISOLATION AND RETURN LOSS PERFORMANCE

Data taken as downconverter, lower sideband (high-side LO), IF = 100 MHz, $T_A = 25^\circ\text{C}$, and LO drive level = 17 dBm, unless otherwise noted. Measurements taken with LO amplifier in line with lab bench LO source.

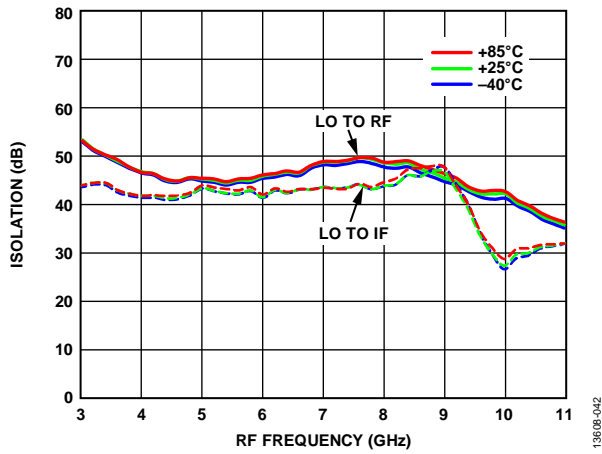

Figure 42. LO to RF and LO to IF Isolation vs. RF Frequency for Various Temperatures, LO Power = 17 dBm

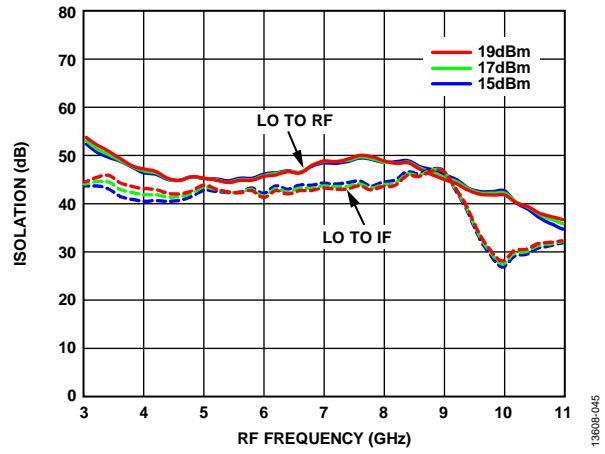

Figure 45. LO to RF and LO to IF Isolation vs. RF Frequency for Various LO Powers, Temperature = 25°C

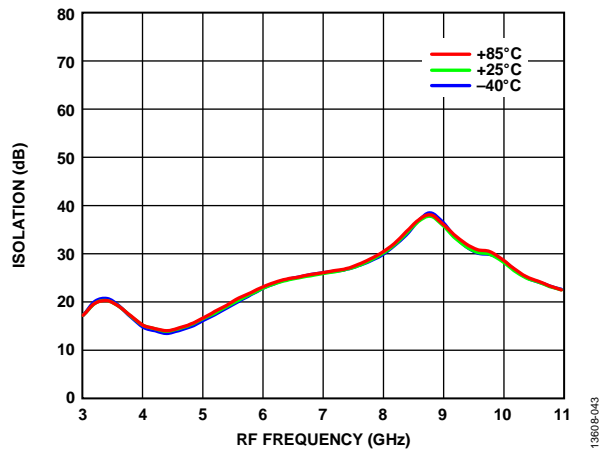

Figure 43. RF to IF Isolation vs. RF Frequency for Various Temperatures, LO Frequency = 7000 MHz, LO Power = 17 dBm

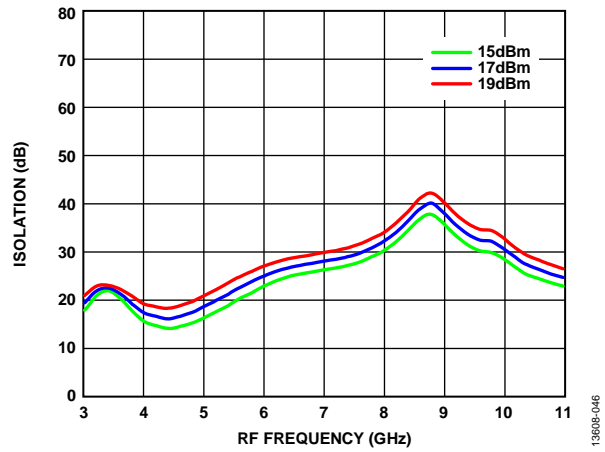

Figure 46. RF to IF Isolation vs. RF Frequency for Various LO Powers, Temperature = 25°C, LO Frequency = 7000 MHz

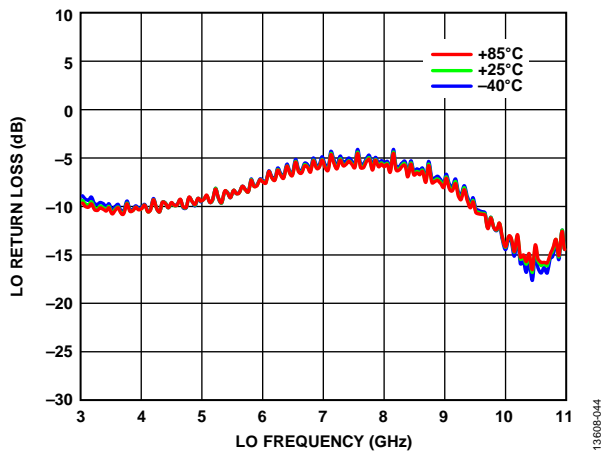

Figure 44. LO Return Loss vs. LO Frequency at Various Temperatures, LO Power = 17 dBm

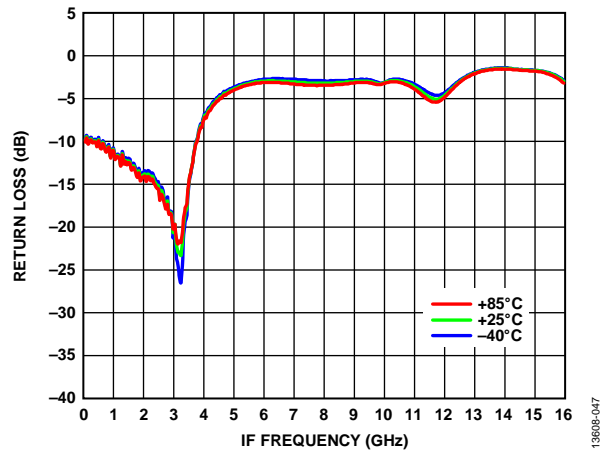

Figure 47. IF Return Loss vs. IF Frequency at Various Temperatures, LO Power = 17 dBm, LO Frequency = 6 GHz

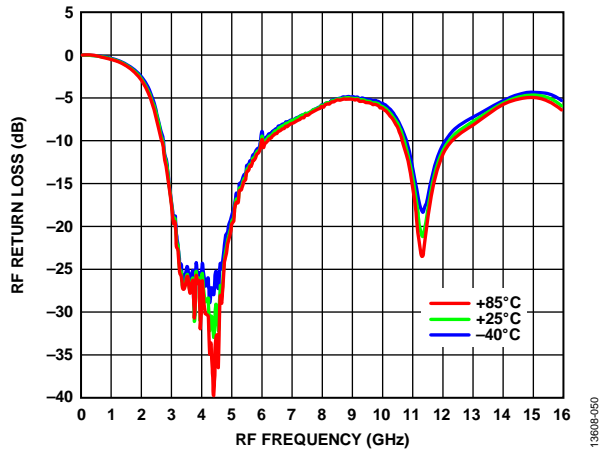

Figure 48. RF Return Loss vs. RF Frequency at Various Temperatures, LO Power = 17 dBm, LO Frequency = 6 GHz

SPURIOUS AND HARMONICS PERFORMANCE

Mixer spurious products are measured in dBc from the IF output power level, unless otherwise noted. Spur values are $(M \times RF) - (N \times LO)$.

LO Harmonics

LO = 17 dBm, and all values in dBc below input LO level measured at RF port.

Table 5. Harmonics of LO

| LO Frequency (GHz) | N _{LO} Spur at RF Port | | | |
|--------------------|---------------------------------|----|----|----|
| | 1 | 2 | 3 | 4 |
| 3 | 55 | 53 | 58 | 59 |
| 6 | 46 | 45 | 64 | 76 |
| 10 | 41 | 57 | 61 | 61 |

M × N Spurious Outputs, IF = 100 MHz

RF = 3.1 GHz, LO = 3 GHz, RF power = -5 dBm, and LO power = 17 dBm.

| | | N × LO | | | | |
|--------|---|----------------|----|----|----|----|
| | | 0 | 1 | 2 | 3 | 4 |
| M × RF | 0 | Not applicable | 14 | 38 | 32 | 54 |
| | 1 | 12.3 | 0 | 25 | 27 | 60 |
| | 2 | 90.1 | 93 | 98 | 94 | 90 |
| | 3 | 91.1 | 90 | 92 | 98 | 94 |
| | 4 | 89.1 | 88 | 91 | 94 | 98 |

RF = 6.1 GHz, LO = 6 GHz, RF power = -5 dBm, and LO power = 17 dBm.

| | | N × LO | | | | |
|--------|---|----------------|----|----|----|----|
| | | 0 | 1 | 2 | 3 | 4 |
| M × RF | 0 | Not applicable | 12 | 26 | 42 | 42 |
| | 1 | 16.3 | 0 | 36 | 35 | 50 |
| | 2 | 89.1 | 91 | 97 | 90 | 88 |
| | 3 | 86.2 | 88 | 88 | 95 | 87 |
| | 4 | 83.1 | 87 | 89 | 90 | 96 |

RF = 10.1 GHz, LO = 10 GHz, RF power = -5 dBm, and LO power = 17 dBm.

| | | N × LO | | | | |
|--------|---|----------------|----|----|----|----|
| | | 0 | 1 | 2 | 3 | 4 |
| M × RF | 0 | Not applicable | 4 | 39 | 36 | 43 |
| | 1 | 19.9 | 0 | 87 | 83 | 79 |
| | 2 | 84.3 | 84 | 97 | 87 | 83 |
| | 3 | 78.4 | 82 | 87 | 97 | 87 |
| | 4 | 72.4 | 78 | 83 | 89 | 95 |

M × N Spurious Outputs, IF = 3000 MHz

RF = 3.1 GHz, LO = 6.1 GHz, RF power = -5 dBm, and LO power = 17 dBm.

| | | N × LO | | | | |
|--------|---|----------------|----|----|----|----|
| | | 0 | 1 | 2 | 3 | 4 |
| M × RF | 0 | Not applicable | 13 | 28 | 44 | 44 |
| | 1 | 13.6 | 0 | 47 | 45 | 64 |
| | 2 | 90.7 | 99 | 89 | 89 | 86 |
| | 3 | 91 | 93 | 94 | 87 | 87 |
| | 4 | 90.2 | 89 | 99 | 92 | 90 |

RF = 6.1 GHz, LO = 3.1 GHz, RF power = -5 dBm, and LO power = 17 dBm.

| | | N × LO | | | | |
|--------|---|----------------|----|----|----|----|
| | | 0 | 1 | 2 | 3 | 4 |
| M × RF | 0 | Not applicable | 13 | 39 | 28 | 50 |
| | 1 | 16 | 0 | 24 | 18 | 90 |
| | 2 | 89 | 88 | 89 | 92 | 97 |
| | 3 | 86 | 86 | 89 | 87 | 89 |
| | 4 | 82 | 86 | 85 | 87 | 89 |

RF = 10.1 GHz, LO = 7.1 GHz, RF power = -5 dBm, and LO power = 17 dBm.

| | | N × LO | | | | |
|--------|---|----------------|----|----|----|----|
| | | 0 | 1 | 2 | 3 | 4 |
| M × RF | 0 | Not applicable | 11 | 28 | 41 | 54 |
| | 1 | 17.7 | 0 | 30 | 35 | 52 |
| | 2 | 82.9 | 86 | 84 | 94 | 86 |
| | 3 | 75 | 81 | 86 | 87 | 92 |
| | 4 | 68 | 76 | 79 | 83 | 87 |

THEORY OF OPERATION

The [HMC787A](#) is a general-purpose, double balanced mixer in a 12-terminal, RoHS compliant, ceramic leadless chip carrier (LCC) package that can be used as an upconverter or down-converter from 3 GHz to 10 GHz. This mixer is fabricated in a gallium arsenide (GaAs), metal semiconductor field effect transistor (MESFET) process and requires no external components or matching circuitry. The [HMC787A](#) provides excellent local

oscillator (LO) to radio frequency (RF) and LO to intermediate frequency (IF) isolation due to optimized balun structures and operates with a LO drive level of 17 dBm. The ceramic LCC package eliminates the need for wire bonding and is compatible with high volume, surface-mount manufacturing techniques.

APPLICATIONS INFORMATION

TYPICAL APPLICATION CIRCUIT

Figure 49 shows the typical application circuit for the [HMC787A](#). The LO and RF pins are internally ac-coupled. When IF operation is not required until dc, it is recommended to use an ac-coupled capacitor at the IF port. When IF operation to dc is required, do not exceed the IF source and sink currents specified in the Absolute Maximum Ratings section.

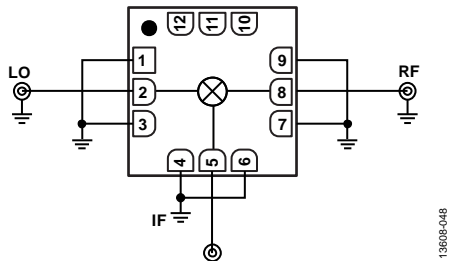

Figure 49. Typical Applications Circuit

EVALUATION PCB INFORMATION

The circuit board used in the application must use RF circuit design techniques. Signal lines must have 50 Ω impedance, and the package ground leads and exposed pad must be connected directly to the ground plane similarly to that shown in Figure 50. Use a sufficient number of via holes to connect the top and bottom ground planes. The evaluation circuit board shown in Figure 50 is available from Analog Devices, Inc., upon request.

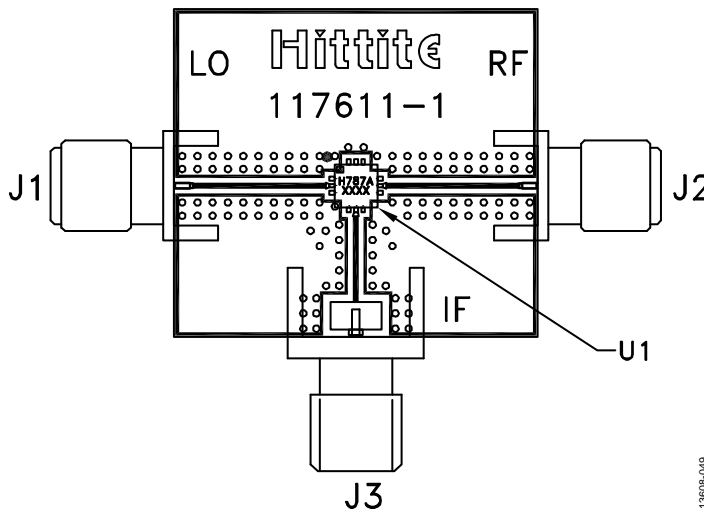

Figure 50. Evaluation PCB Top Layer

Table 6. Bill of Materials for the [EV1HMC787ALC3B](#) Evaluation PCB

| Quantity | Reference Designator | Part Number | Description |
|----------|----------------------|----------------------------|-------------------------|
| 1 | | 117611-1 | PCB, evaluation board |
| 2 | J1 to J2 | 104935 | 2.92 mm connectors, SRI |
| 1 | J3 | 105192 | SMA connector, Johnson |
| 1 | U1 | HMC787ALCB | Device under test (DUT) |

OUTLINE DIMENSIONS

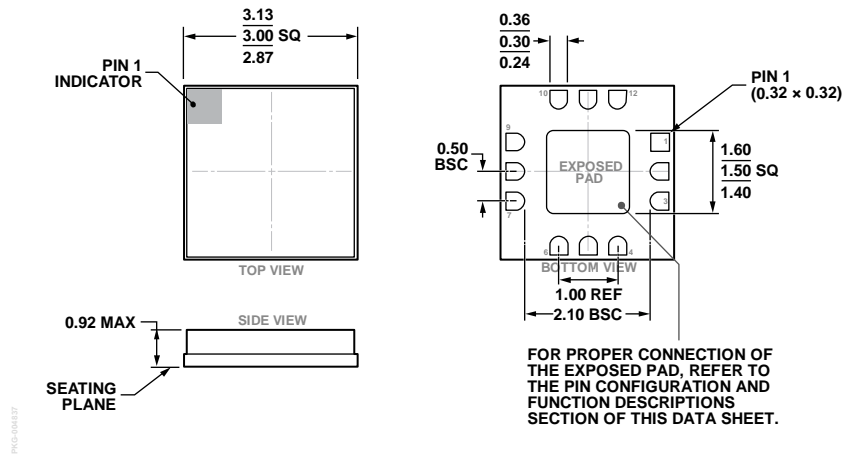

Figure 51. 12-Terminal Ceramic Leadless Chip Carrier [LCC] (E-12-1)
Dimensions shown in millimeters

ORDERING GUIDE

| Model ¹ | Temperature Range | Package Body Material | Lead Finish | MSL Rating ² | Package Description | Package Option | Package Marking ³ |
|--------------------|-------------------|-----------------------|------------------|-------------------------|---|----------------|------------------------------|
| HMC787ALC3B | -40°C to +85°C | Alumina Ceramic | Gold over Nickel | MSL3 | 12-Terminal Ceramic Leadless Chip Carrier [LCC] | E-12-1 | H787A XXXX |
| HMC787ALC3BTR | -40°C to +85°C | Alumina Ceramic | Gold over Nickel | MSL3 | 12-Terminal Ceramic Leadless Chip Carrier [LCC] | E-12-1 | H787A XXXX |
| HMC787ALC3BTR-R5 | -40°C to +85°C | Alumina Ceramic | Gold over Nickel | MSL3 | 12-Terminal Ceramic Leadless Chip Carrier [LCC] | E-12-1 | H787A XXXX |
| EV1HMC787ALC3B | | | | | Evaluation PCB Assembly | | |

¹ The HMC787ALC3B, the HMC787ALC3BTR, and the HMC787ALC3BTR-R5 are RoHS Compliant Parts.
² See the Absolute Maximum Ratings section.
³ The HMC787ALC3B, the HMC787ALC3BTR, and the HMC787ALC3BTR-R5 have a four digit lot number.