

PowerLogic™ PM5500 series

User manual

HRB1684301-04

02/2016



Legal Information

The Schneider Electric brand and any registered trademarks of Schneider Electric Industries SAS referred to in this guide are the sole property of Schneider Electric SA and its subsidiaries. They may not be used for any purpose without the owner's permission, given in writing. This guide and its content are protected, within the meaning of the French intellectual property code (Code de la propriété intellectuelle français, referred to hereafter as "the Code"), under the laws of copyright covering texts, drawings and models, as well as by trademark law. You agree not to reproduce, other than for your own personal, noncommercial use as defined in the Code, all or part of this guide on any medium whatsoever without Schneider Electric's permission, given in writing. You also agree not to establish any hypertext links to this guide or its content. Schneider Electric does not grant any right or license for the personal and noncommercial use of the guide or its content, except for a non-exclusive license to consult it on an "as is" basis, at your own risk. All other rights are reserved.

Electrical equipment should be installed, operated, serviced, and maintained only by qualified personnel. No responsibility is assumed by Schneider Electric for any consequences arising out of the use of this material.

As standards, specifications, and designs change from time to time, please ask for confirmation of the information given in this publication.

Safety information

Important information

Read these instructions carefully and look at the equipment to become familiar with the device before trying to install, operate, service or maintain it. The following special messages may appear throughout this bulletin or on the equipment to warn of potential hazards or to call attention to information that clarifies or simplifies a procedure.



The addition of either symbol to a “Danger” or “Warning” safety label indicates that an electrical hazard exists which will result in personal injury if the instructions are not followed.



This is the safety alert symbol. It is used to alert you to potential personal injury hazards. Obey all safety messages that follow this symbol to avoid possible injury or death.

DANGER

DANGER indicates a hazardous situation which, if not avoided, **will result in** death or serious injury.

WARNING

WARNING indicates a hazardous situation which, if not avoided, **could result in** death or serious injury.

CAUTION

CAUTION indicates a hazardous situation which, if not avoided, **could result in** minor or moderate injury.

NOTICE

NOTICE is used to address practices not related to physical injury.

Please note

Electrical equipment should be installed, operated, serviced and maintained only by qualified personnel. No responsibility is assumed by Schneider Electric for any consequences arising out of the use of this material. A qualified person is one who has skills and knowledge related to the construction, installation, and operation of electrical equipment and has received safety training to recognize and avoid the hazards involved.

Notices

FCC

This equipment has been tested and found to comply with the limits for a Class B digital device, pursuant to part 15 of the FCC rules. These limits are designed to provide reasonable protection against harmful interference in a residential installation. This equipment generates, uses, and can radiate radio frequency energy and, if not installed and used in accordance with the instructions, may cause harmful interference to radio communications. However, there is no guarantee that the interference will not occur in a particular installation. If this equipment does cause harmful interference to radio or television reception, which can be determined by turning the equipment off and on, the user is encouraged to try to correct the interference by one or more of the following measures:

- Reorient or relocate the receiving antenna.
- Increase the separation between the equipment and receiver.
- Connect the equipment to an outlet on a circuit different from that to which the receiver is connected.
- Consult the dealer or an experienced radio/TV technician for help.

The user is cautioned that any changes or modifications not expressly approved by Schneider Electric could void the user's authority to operate the equipment.

This digital apparatus complies with CAN ICES-3 (B) /NMB-3(B).

Table of Contents

Safety precautions	11
Meter overview	12
Overview of meter features	12
Hardware	12
Display and user interface	12
Alarming	12
Communications	12
Measurements and logging	12
Revenue and tariffs	13
Your meter in an energy management system	13
Data display and analysis tools	14
Meter configuration	15
Hardware reference	16
LED indicators	16
Terminal covers	17
Removing the PM5563 from the DIN rail	17
Meter wiring considerations	18
Communications connections	21
Digital outputs	22
Digital inputs	22
Meter display	23
Display overview	23
Default data display screen	23
Default display screen: PM5560 and PM5RD	23
Default display screen: PM5561	23
LED indicators on the display	24
Notification icons	24
Meter display language	25
Meter screen navigation	25
HMI setup screens	31
Setting up the display	32
Basic setup	33
Configuring basic setup parameters using the display	33
Configuring advanced setup parameters using the display	35
Setting up regional settings	35
Resetting the display language	36
Setting up the screen passwords	36
Setting the clock	37
Security	39
Security overview	39
Security features on your meter	39
Security configuration recommendations	40
Meter webpages	41
Webpages overview	41
Webpages interface	41
Accessing the meter webpages	41
Default webpages	42

Monitoring	42
Diagnostics	42
Maintenance.....	43
Setting the measurement range for basic parameters	43
User accounts	43
Reading device registers using the webpages	44
Communications	46
Ethernet communications	46
Ethernet configuration	46
Serial communications	51
RS-485 network configuration	51
BACnet/IP.....	54
Supported BACnet features	55
BACnet/IP communications implementation.....	56
BACnet objects.....	58
Modbus Ethernet gateway.....	67
Ethernet gateway implementation	68
Ethernet gateway configuration.....	68
Modbus TCP/IP filtering	70
Simple Network Management Protocol (SNMP).....	71
Key terms.....	71
FTP	74
Time and timekeeping	76
Setting the clock	76
Setting the meter's clock manually using the webpages.....	76
Configuring time and time synchronization using the webpages	77
Logging.....	78
Data log	78
Setting up the data log.....	78
Saving the data log contents using ION Setup.....	78
Setting up device log exports using the webpages.....	79
Alarm log	80
Maintenance log.....	80
Inputs / outputs.....	81
I/O ports.....	81
Digital input applications.....	81
Digital input wiring considerations	81
WAGES monitoring	81
Configuring digital inputs using ION Setup	82
Configuring digital inputs using the display.....	82
Input metering	83
Configuring input metering using ION Setup.....	84
Configuring input metering using the display	84
Demand measurements for input metering.....	85
Viewing input metering data through the meter's display	86
Digital output applications	86
Digital output application example	86
Configuring digital outputs using ION Setup	87
Configuring digital outputs using the display.....	88
Energy pulsing	89

Configuring the alarm / energy pulsing LED using the display	90
Configuring the alarm / energy pulsing LED or digital output for energy pulsing using ION Setup	90
Resets	92
Meter resets	92
Meter Initialization	92
Performing global resets using the display	92
Performing single resets using the display	92
Alarm counter reset options	93
Alarms	96
Alarms overview	96
Alarm types	96
Unary alarms.....	96
Available unary alarms	96
Digital alarms	96
Digital alarm with setpoint delay	96
Available digital alarms.....	97
Standard alarms	97
Example of over and under setpoint (standard) alarm operation.....	97
Maximum allowable setpoint	98
Available standard alarms	99
Logic alarms	101
Custom alarms	102
Alarm priorities	103
Multiple alarm considerations.....	103
Alarm setup overview.....	103
Built-in error-checking	104
LED alarm indicator	108
Alarm display and notification	109
Alarm icon	109
Alarm / energy pulsing LED	109
Alarm screens	109
Active alarms.....	109
Alarm details	109
Email on alarm	109
Example email.....	110
Active alarms list and alarm history log	113
Acknowledging high-priority alarms using the display	114
Resetting alarms using ION Setup	114
Multi-tariffs	115
Multi-tariff overview.....	115
Multi-tariff implementation	115
Command mode overview.....	115
Time of day mode overview	116
Time of day mode tariff validity	116
Time of day tariff creation methods.....	116
Input mode overview.....	117
Digital input assignment for input control mode.....	117
Tariff setup	118
Time of day mode tariff configuration considerations.....	118

Input mode tariff configuration considerations	119
Configuring input mode tariffs using the display	119
Measurements	120
Instantaneous measurements	120
Energy measurements	120
Min/max values	120
Demand measurements	120
Power demand	121
Current demand.....	123
Input Metering Demand	124
Setting up demand calculations.....	124
Power and power factor	125
Power factor (PF).....	126
Timers	130
Operating Timer.....	130
Load Timer	130
I/O timer.....	130
Power quality	131
Power quality measurements	131
Harmonics overview	131
Voltage crest factor	131
K-factor.....	132
Total harmonic distortion	132
Total demand distortion	132
Harmonic content calculations	132
THD% calculations	132
thd calculations	133
TDD calculations	133
Viewing harmonics using the display	133
Viewing TDD, K-factor and Crest factor data	134
Viewing THD/thd using the display	135
Maintenance	136
Maintenance overview	136
Lost user access	136
Diagnostics information.....	136
Wrench icon.....	136
Troubleshooting LED indicators	136
Phasors	137
Phasor screens.....	137
Meter memory	138
Meter battery.....	138
Firmware version, model and serial number.....	138
Firmware upgrades.....	138
Meter upgrade requirements.....	138
Upgrading your meter.....	139
Technical assistance.....	140
Verifying accuracy	141
Overview of meter accuracy	141
Accuracy test requirements	141
Signal and power source	141

Control equipment	141
Environment	141
Reference device or energy standard	142
Meter settings for accuracy testing	142
Verifying accuracy test	142
Required pulses calculation for accuracy verification testing	144
Total power calculation for accuracy verification testing	144
Percentage error calculation for accuracy verification testing	144
Accuracy verification test points	145
Energy pulsing considerations	145
VT and CT considerations	146
Example calculations	146
Adjustments to allow energy pulsing at the digital outputs	147
Typical sources of test errors	147
MID compliance	148
MID overview	148
Scope	148
MID compliance for the meter	148
Terminal covers and MID compliance	148
Firmware version, model and serial number	148
MID-protected setup parameters	149
Alarm / energy pulsing LED	149
Lock-protected setup parameters	149
Lock-protected functions	149
PM5561 configuration	150
MID configuration considerations	150
Locking or unlocking the PM5561	150
Device specifications	151

Safety precautions

Installation, wiring, testing and service must be performed in accordance with all local and national electrical codes.

DANGER

HAZARD OF ELECTRIC SHOCK, EXPLOSION, OR ARC FLASH

- Apply appropriate personal protective equipment (PPE) and follow safe electrical work practices. See NFPA 70E in the USA, CSA Z462 or applicable local standards.
- Turn off all power supplying this device and the equipment in which it is installed before working on the device or equipment.
- Always use a properly rated voltage sensing device to confirm that all power is off.
- Treat communications and I/O wiring connected to multiple devices as hazardous live until determined otherwise.
- Do not exceed the device's ratings for maximum limits.
- Never short the secondary of a potential/voltage transformer (PT/VT).
- Never open circuit a current transformer (CT).
- Always use grounded external CTs for current inputs.
- Do not use the data from the meter to confirm power is off.
- Replace all devices, doors and covers before turning on power to this equipment.

Failure to follow these instructions will result in death or serious injury.

NOTE: See IEC 60950-1:2005, Annex W for more information on communications and I/O wiring connected to multiple devices.

WARNING

UNINTENDED OPERATION

Do not use this device for critical control or protection applications where human or equipment safety relies on the operation of the control circuit.

Failure to follow these instructions can result in death, serious injury, or equipment damage.

Meter overview

Overview of meter features

The PowerLogic™ PM5500 power meters offer value for the demanding needs of your energy monitoring and cost management applications.

The PM5500 complies to Class 0.2S accuracy standards and feature high quality, reliability and affordability in a compact and easy to install format.

For applications, feature details and the most current and complete specifications of the PM5500 meters, see the PM5500 technical datasheet at www.schneider-electric.com.

Hardware

- A fourth current input for direct and accurate measurement of neutral current, to help avoid device overload and network outage.
- Two digital outputs for control and energy pulsing applications.
- Four digital inputs with input metering support for WAGES monitoring applications.
- LED that can be used for energy pulsing applications.

Display and user interface

- Onboard webpages for displaying real-time and logged data using a web browser.
- Multiple language support: The back-lit anti-glare display screen can be switched to display meter information in one of the supported languages (on models with a display screen).
- Graphical display of harmonics and phasor diagrams on models with an integrated or optional remote display.
- QR codes with embedded data for viewing meter information using Meter Insights.

Alarming

- Extensive alarming options, including logic and custom alarms.
- The ability to send emails with alarm information.

Communications

- Dual Ethernet switched ports allow fast Ethernet interconnection to other PM5500 meters using only one IP switch.
- Ethernet gateway functionality, allowing a Modbus master using Modbus TCP to communicate through the meter to downstream serial devices using Modbus RTU.
- Support for a variety of Ethernet protocols, such as Modbus TCP and BACnet/IP.
- Enhanced Modbus security using TCP/IP filtering to set the specific IP addresses that are permitted to access the meter.

Measurements and logging

- 4-quadrant, Class 0.2S accurate energy metering.
- Present, last, predicted and peak (maximum) demand using a selection of demand calculation methods.

- Highly accurate 1-second measurements.
- Onboard data logging support for up to 14 selectable parameters.
- Complete harmonic distortion metering, recording and realtime reporting, up to the 63rd harmonic for all voltage and current inputs.
- Recording of each new minimum and new maximum value with date and timestamp.

Revenue and tariffs

- Multiple tariff support (8 tariffs) for monitoring energy usage.
- MID-compliant model.

Your meter in an energy management system

You can use the meter as a stand-alone device, but its extensive capabilities are fully realized when used as part of an energy management system.



Perform basic setup using the LCD display, the meter webpages or ION Setup	Configure the meter to help protect against unauthorized configuration and access to your meter's data
Access highly accurate measurements and calculations for a wide variety of power system values	Improve energy efficiency and track compliance to green standards
Use the onboard I/O for non-critical control, WAGES and input metering, energy pulsing and system monitoring (for example, breaker status)	Help prolong asset life with proactive network management
Receive notifications of predefined meter and system events or create custom alarms	Track energy by tariff and perform cost allocation/tenant billing
Monitor harmonic distortion up to the 63rd harmonic for all voltage and current inputs	Easily access information after basic configuration using: <ul style="list-style-type: none"> • a variety of industry-standard protocols • software such as Power Monitoring Expert, PowerSCADA Expert, and Building Operation • the meter's internal webpages • the optional remote display (DIN models) • from downstream devices by using the meter as a gateway • data embedded in QR codes on the meter's display
Log data in a number of onboard default logs, or customize your meter to log other parameters, and access that information using software or webpages	

PM5500 meter models and accessories

The meter is available in several different models with optional accessories that provide various mounting options.

Meter models

Model	Commercial reference	Description
PM5560	METSEPM5560	Front panel mount, integrated display, 96 x 96 mm form factor, fits in a 1/4 DIN mounting hole.
PM5561	METSEPM5561	Same as the PM5560, except the meter is calibrated to comply to strict MID standards.
PM5563	METSEPM5563	Transducer (TRAN) model, no display, mounts on a standard TS35 top hat style DIN rail.

Meter accessories

Model	Commercial reference	Description
PM5RD	METSEPM5RD	The remote meter display can be used with DIN meters. It has the same buttons, icons and LEDs as the display on an integrated meter, and is powered by the connection to the DIN meter. NOTE: A remote display cannot be used with meters that have an integrated display.

See the PM5500 catalog pages, available from www.schneider-electric.com, or consult your local Schneider Electric representative for information about mounting adapters available for your meter.

Data display and analysis tools

Power Monitoring Expert

StruxureWare™ Power Monitoring Expert is a complete supervisory software package for power management applications. The software collects and organizes data gathered from your facility's electrical network and presents it as meaningful, actionable information via an intuitive web interface.

Power Monitoring Expert communicates with devices on the network to provide:

- Real-time monitoring through a multi-user web portal
- Trend graphing and aggregation
- Power quality analysis and compliance monitoring
- Preconfigured and custom reporting

See the StruxureWare™ Power Monitoring Expert online help for instructions on how to add your meter into its system for data collection and analysis.

PowerScada Expert

StruxureWare™ PowerScada Expert is a complete real-time monitoring and control solution for large facility and critical infrastructure operations.

It communicates with your meter for data acquisition and real-time control. You can use PowerScada Expert for:

- System supervision
- Real-time and historical trending, event logging and waveform capture
- PC-based custom alarms

See the StruxureWare™ PowerScada Expert online help for instructions on how to add your meter into its system for data collection and analysis.

Building Operation

Struxtureware™ Building Operation is a complete software solution for integrated monitoring, control, and management of energy, lighting, fire safety, and HVAC.

It natively supports the major communication standards in building automation and security management, including TCP/IP, LonWorks, BACnet, Modbus and Ethernet.

Modbus command interface

Most of the meter's real-time and logged data, as well as basic configuration and setup of meter features, can be accessed and programmed using a Modbus command interface and the meter's Modbus register list.

This is an advanced procedure that should only be performed by users with advanced knowledge of Modbus, their meter, and the power system being monitored. For further information on the Modbus command interface, contact Technical Support.

See your meter's Modbus register list at www.schneider-electric.com for the Modbus mapping information and basic instructions on command interface.

Meter Insights and QR code-enabled meters

The QR code feature allows you to view meter data using the Meter Insights website by scanning a QR code on the meter's display.

The meter dynamically generates the selected QR code when you navigate to the appropriate screen. The data embedded in the QR code is displayed in Meter Insights using the web browser on your smartphone or tablet.

You can register with Meter Insights to store the results of your scans, which allows you to view:

- Detailed energy usage patterns
- Trends in energy consumption
- Alarms for possible issues

Meter Insights also displays notifications of possible issues or improvements you can make to the meter's configuration or your electrical network. Plus you can share information with colleagues and run reports on stored data.

See the *Meter Insights QR code feature quick start guide*, available from www.schneider-electric.com, for information on using Meter Insights and the QR code feature on your meter.

Meter configuration

Meter configuration can be performed through the display (if your meter is equipped with one), the webpages or PowerLogic™ ION Setup.

ION Setup is a meter configuration tool that can be downloaded for free at www.schneider-electric.com.

See the ION Setup online help or in the ION Setup device configuration guide. To download a copy, go to www.schneider-electric.com and search for ION Setup device configuration guide.

Hardware reference

Supplemental information

This document is intended to be used in conjunction with the installation sheet that ships in the box with your meter and accessories.

See your device's installation sheet for information related to installation.

See your product's technical datasheet at www.schneider-electric.com for the most up-to-date and complete specifications.

See your product's catalog pages at www.schneider-electric.com for information about your device, its options and accessories.

You can download updated documentation from www.schneider-electric.com or contact your local Schneider Electric representative for the latest information about your product.

Related Topics

- Device specifications

LED indicators

The LED indicators alert or inform you of meter activity.

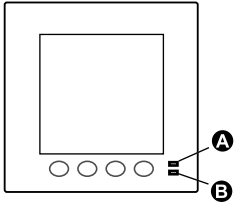
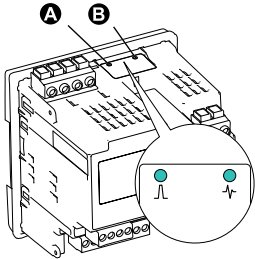
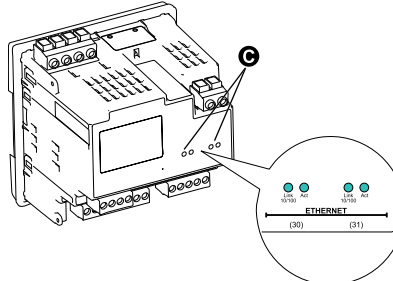
PM5560 / PM5561 / PM5RD		PM5563	PM5560 / PM5561 / PM5563
			
A	Alarm / energy pulsing LED		
B	Heartbeat / serial communications LED		
C	Ethernet communications LEDs		

Alarm / energy pulsing LED

The alarm / energy pulsing LED can be configured for alarm notification or energy pulsing.

When configured for alarm notification, this LED flashes when a high, medium or low priority alarm is tripped. The LED provides a visual indication of an active alarm condition or an inactive but unacknowledged high priority alarm.

When configured for energy pulsing, this LED flashes at a rate proportional to the amount of energy consumed. This is typically used to verify the power meter's accuracy.

NOTE: The alarm / energy pulsing LED on the PM5561 is permanently set for energy pulsing and cannot be disabled or used for alarms.

Heartbeat / serial communications LED

The heartbeat / serial communications LED blinks to indicate the meter's operation and serial Modbus communications status.

The LED blinks at a slow, steady rate to indicate the meter is operational. The LED flashes at a variable, faster rate when the meter is communicating over a Modbus serial communications port.

You cannot configure this LED for other purposes.

NOTE: A heartbeat LED that remains lit and does not blink (or flash) can indicate a hardware problem.

Ethernet communications LEDs

The meter has two LEDs per port for Ethernet communications.

The Link LED is on when there is a valid Ethernet connection. The Act (active) LED flashes to indicate the meter is communicating through the Ethernet port.

You cannot configure these LEDs for other purposes.

Terminal covers

The voltage and current terminal covers help prevent tampering with the meter's voltage and current measurement inputs.

The terminal covers enclose the terminals, the conductor fixing screws and a length of the external conductors and their insulation. The terminal covers are secured by tamper-resistant meter seals.

These covers are included for meter models where sealable voltage and current covers are required to comply with revenue or regulatory standards.

The meter terminal covers must be installed by a qualified installer.

Refer to the Sealing kit instruction sheet for instructions on installing the terminal covers.

Removing the PM5563 from the DIN rail

Follow these instructions to remove the meter from a TS35 Top-Hat style DIN rail.

Installation, wiring, testing and service must be performed in accordance with all local and national electrical codes.

DANGER

HAZARD OF ELECTRIC SHOCK, EXPLOSION, OR ARC FLASH

- Apply appropriate personal protective equipment (PPE) and follow safe electrical work practices. See NFPA 70E in the USA, CSA Z462 or applicable local standards.
- Turn off all power supplying this device and the equipment in which it is installed before working on the device or equipment.
- Always use a properly rated voltage sensing device to confirm that all power is off.
- Do not exceed the device's ratings for maximum limits.
- Never short the secondary of a potential/voltage transformer (PT/VT).
- Never open circuit a current transformer (CT).
- Always use grounded external CTs for current inputs.
- Replace all devices, doors and covers before turning on power to this equipment.

Failure to follow these instructions will result in death or serious injury.

1. Turn off all power supplying this device and the equipment in which it is installed before working on it.
2. Always use a properly rated voltage sensing device to confirm that all power is off.
3. Insert a flat-tip screwdriver into the DIN release clip. Pull down the clip until you hear an audible click and the DIN clip is unlocked.

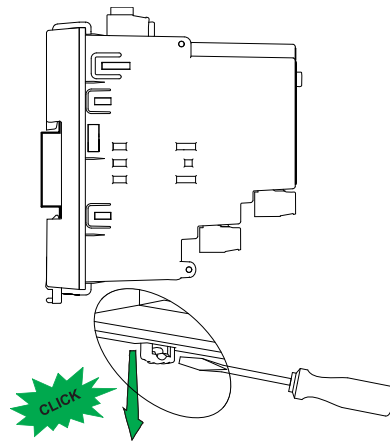

4. Swing the meter out and upwards to remove the meter.

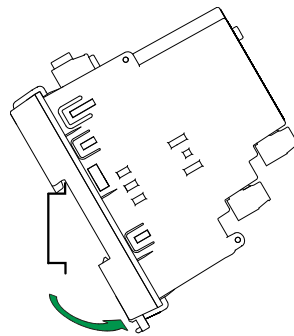



Meter wiring considerations

Direct connect voltage limits

You can connect the meter's voltage inputs directly to the phase voltage lines of the power system if the power system's line-to-line or line-to-neutral voltages do not exceed the meter's direct connect maximum voltage limits.

The meter's voltage measurement inputs are rated by the manufacturer for up to 400 V L-N / 690 V L-L. However, the maximum voltage allowed for direct connection may be lower, depending on the local electrical codes and regulations. In US and Canada the maximum voltage on the meter voltage measurement inputs may not exceed 347 V L-N / 600 V L-L.

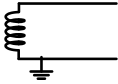
If your system voltage is greater than the specified direct connect maximum voltage, you must use VTs (voltage transformers) to step down the voltages.

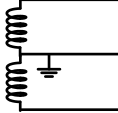
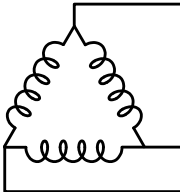
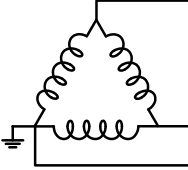
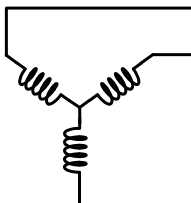
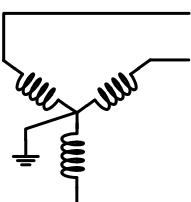
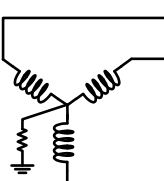
Power system description	Meter setting	Symbol	Direct connect maximum (UL)	Direct connect maximum (IEC)	# of VTs (if required)
Single-phase 2-wire line-to-neutral	1PH2W LN		480 V L-N	480 V L-N	1 VT
Single-phase 2-wire line-to-line	1PH2W LL		600 V L-L	600 V L-L	1 VT
Single-phase 3-wire line-to-line with neutral	1PH3W LL with N		347 V L-N / 600 V L-L	400 V L-N / 690 V L-L	2 VT
3-phase 3-wire Delta ungrounded	3PH3W Dlt Ungnd		600 V L-L	600 V L-L	2 VT
3-phase 3-wire Delta corner grounded	3PH3W Dlt Crnr Gnd		600 V L-L	600 V L-L	2 VT
3-phase 3-wire Wye ungrounded	3PH3W Wye Ungnd		600 V L-L	600 V L-L	2 VT
3-phase 3-wire Wye grounded	3PH3W Wye Gnd		600 V L-L	600 V L-L	2 VT
3-phase 3-wire Wye resistance-grounded	3PH3W Wye Res Gnd		600 V L-L	600 V L-L	2 VT

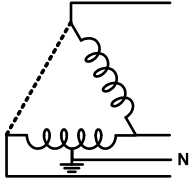
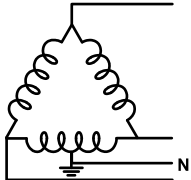
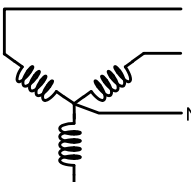
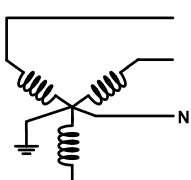
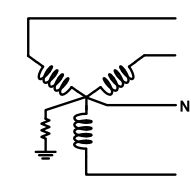
Power system description	Meter setting	Symbol	Direct connect maximum (UL)	Direct connect maximum (IEC)	# of VTs (if required)
3-phase 4-wire open Delta center-tapped	3PH4W Opn Dlt Ctr Tp		240 V L-N / 415 V L-N / 480 V L-L	240 V L-N / 415 V L-N / 480 V L-L	3 VT
3-phase 4-wire Delta center-tapped	3PH4W Dlt Ctr Tp		240 V L-N / 415 V L-N / 480 V L-L	240 V L-N / 415 V L-N / 480 V L-L	3 VT
3-phase 4-wire ungrounded Wye	3PH4W Wye Ungnd		347 V L-N / 600 V L-L	347 V L-N / 600 V L-L	3 VT or 2 VT
3-phase 4-wire grounded Wye	3PH4W Wye Gnd		347 V L-N / 600 V L-L	400 V L-N / 690 V L-L	3 VT or 2 VT
3-phase 4-wire resistance-grounded Wye	3PH4W Wye Res Gnd		347 V L-N / 600 V L-L	347 V L-N / 600 V L-L	3 VT or 2 VT

Balanced system considerations

In situations where you are monitoring a balanced 3-phase load, you may choose to connect only one or two CTs on the phase(s) you want to measure, and then configure the meter so it calculates the current on the unconnected current input(s).

NOTE: For a balanced 4-wire Wye system, the meter’s calculations assume that there is no current flowing through the neutral conductor.

Balanced 3-phase Wye system with 2 CTs

The current for the unconnected current input is calculated so that the vector sum for all three phases equal zero.

Balanced 3-phase Wye or Delta system with 1CT

The currents for the unconnected current inputs are calculated so that their magnitude and phase angle are identical and equally distributed, and the vector sum for all three phase currents equal zero.

NOTE: You must always use 3 CTs for 3-phase 4-wire center-tapped Delta or center-tapped open Delta systems.

Neutral and ground current

The fourth current input (I4) can be used to measure current flow (In) in the neutral conductor, which can then be used to calculate residual current. The meter refers to residual current as ground current (Ig).

For 4-wire Wye systems, ground current is calculated as the difference between the measured neutral current and the vector sum of all measured phase currents.

Communications connections

RS-485 wiring

Connect the devices on the RS-485 bus in a point-to-point configuration, with the (+) and (-) terminals from one device connected to the corresponding (+) and (-) terminals on the next device.

RS-485 cable

Use a shielded 2 twisted pair or 1.5 twisted pair RS-485 cable to wire the devices. Use one twisted pair to connect the (+) and (-) terminals, and use the other insulated wire to connect the C terminals

The total distance for devices connected on an RS-485 bus should not exceed 1200 m (4000 ft).

RS-485 terminals

C	Common. This provides the voltage reference (zero volts) for the data plus and data minus signals
	Shield. Connect the bare wire to this terminal to help suppress signal noise that may be present. Ground the shield wiring at one end only (either at the master or the last slave device, but not both).
-	Data minus. This transmits/receives the inverting data signals.
+	Data plus. This transmits/receives the non-inverting data signals.

NOTE: If some devices in your RS-485 network do not have the C terminal, use the bare wire in the RS-485 cable to connect the C terminal from the meter to the shield terminal on the devices that do not have the C terminal.

Related Topics

- RS-485 port setup
- Configuring serial settings using the webpages
- Setting up serial communications using the display

Ethernet communications connections

Use a Cat 5 cable to connect the meter's Ethernet port.

Your Ethernet connection source should be installed in a location that minimizes the overall Ethernet cable routing length.

Related Topics

- Setting up Ethernet communications using the display
- Configuring basic Ethernet settings using the webpages
- Ethernet port setup

Digital outputs

The meter is equipped with two Form A digital output ports (D1, D2).

You can configure the digital outputs for use in the following applications:

- switching applications, for example, to provide on/off control signals for switching capacitor banks, generators, and other external devices and equipment
- demand synchronization applications, where the meter provides pulse signals to the input of another meter to control its demand period
- energy pulsing applications, where a receiving device determines energy usage by counting the kWh pulses coming from the meter's digital output port

The digital outputs can handle voltages less than 30 V AC or 60 V DC (125 mA maximum). For higher voltage applications, use an external relay in the switching circuit.

Related Topics

- Digital output applications

Digital inputs

The meter is equipped with four digital input ports (S1 to S4).

You can configure the digital inputs for use in status monitoring or input metering applications.

The meter's digital inputs require an external voltage source to detect the digital input's on/off state. The meter detects an on state if the external voltage appearing at the digital input is within its operating range.

The digital inputs require a 18 - 30 V AC or 12 - 30 V DC external voltage source to detect the digital input's on/off state.

Related Topics

- Digital input applications

Meter display

Display overview

The display (integrated or remote) lets you use the meter to perform various tasks such as setting up the meter, displaying data screens, acknowledging alarms, or performing resets.

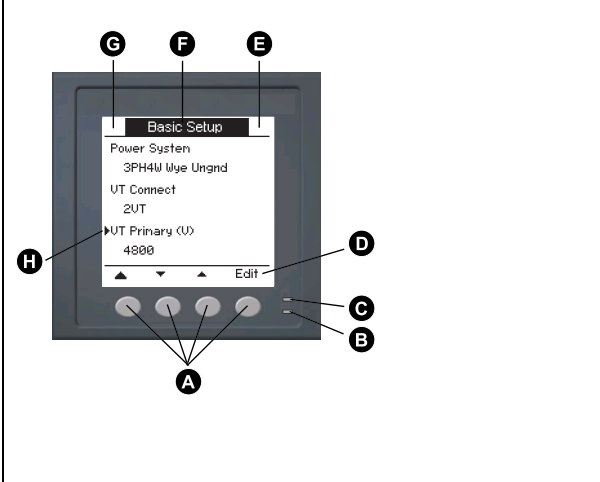

A	Navigation / menu selection buttons
B	Heartbeat / communications LED (green)
C	Alarm / energy pulsing LED (orange)
D	Navigation symbols or menu options
E	Right notification area
F	Screen title
G	Left notification area
H	Cursor

Default data display screen

The default data display screen varies depending on the meter model.

Default display screen: PM5560 and PM5RD

The Summary screen displays real-time values for average voltage and current (Vavg, Iavg), total power (Ptot) and energy consumption (E Del).



Default display screen: PM5561

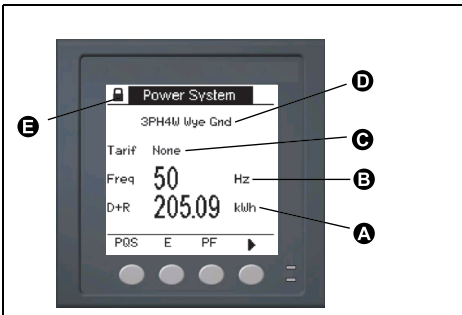

A	Accumulated real energy (delivered + received)
B	System frequency
C	Active tariff
D	Power system setting
E	Locked / unlocked icon

LED indicators on the display

The display has two LED indicators.

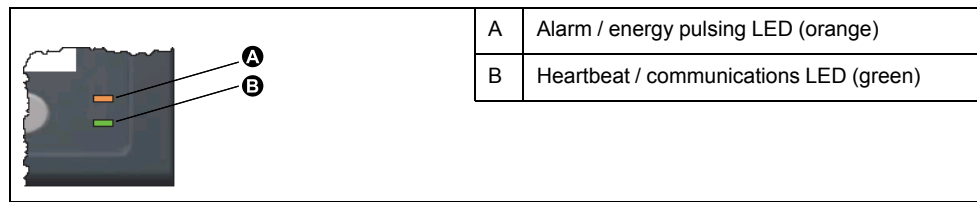

NOTE: For the PM5561 model, the alarm / energy pulsing LED is factory set for energy pulsing only and cannot be modified or disabled.

Heartbeat / serial communications LED

The heartbeat / serial communications LED blinks to indicate the meter's operation and serial Modbus communications status.

The LED blinks at a slow, steady rate to indicate the meter is operational. The LED flashes at a variable, faster rate when the meter is communicating over a Modbus serial communications port.

You cannot configure this LED for other purposes.

NOTE: A heartbeat LED that remains lit and does not blink (or flash) can indicate a hardware problem.

Related Topics

- Troubleshooting LED indicators

Alarm / energy pulsing LED

The alarm / energy pulsing LED can be configured for alarm notification or energy pulsing.

When configured for alarm notification, this LED flashes when a high, medium or low priority alarm is tripped. The LED provides a visual indication of an active alarm condition or an inactive but unacknowledged high priority alarm.

When configured for energy pulsing, this LED flashes at a rate proportional to the amount of energy consumed. This is typically used to verify the power meter's accuracy.



NOTE: The alarm / energy pulsing LED on the PM5561 is permanently set for energy pulsing and cannot be disabled or used for alarms.

Related Topics

- LED alarm indicator
- Energy pulsing

Notification icons

To alert you about meter state or events, notification icons appear at the top left or top right corner of the display screen.

Icon	Description
	The wrench icon indicates that the power meter is in an overvoltage condition or requires maintenance. It could also indicate that the energy LED is in an overrun state.
	The alarm icon indicates an alarm condition has occurred.

Related Topics

- Wrench icon
- Alarm display and notification

Meter display language

If your meter is equipped with a display screen, you can configure the meter to display the measurements in one of several languages.

The following languages are available:

- English
- French
- Spanish
- German
- Italian
- Portuguese
- Russian
- Chinese

Related Topics

- Setting up regional settings

Resetting the display language

To reset the meter to the default language (English), press and hold the outermost two buttons for 5 seconds.

Meter screen navigation

The meter's buttons and display screen allow you to navigate data and setup screens, and to configure the meter's setup parameters.

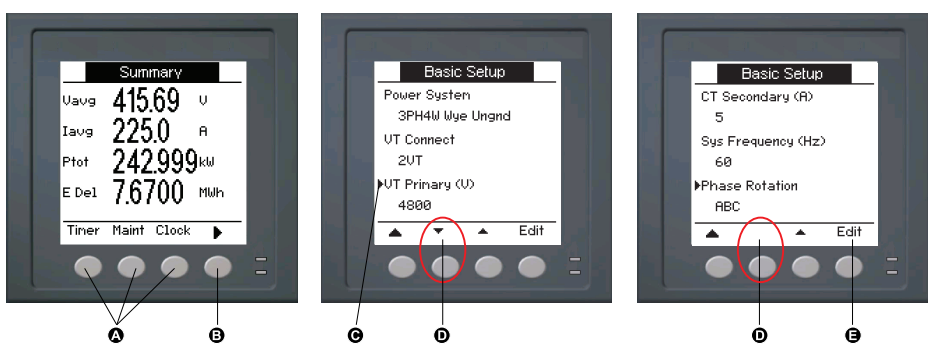
	A	Press the button below the appropriate menu to view that screen
	B	Press the right arrow to view more screens
	C	In setup mode, a small right arrow indicates the selected option
	D	In setup mode, a small down arrow indicates that there are additional parameters to display. The down arrow disappears when there are no more parameters to display.

	E	In setup mode, press the button under Edit to change that setting
--	---	--

Navigation symbols

Navigation symbols indicate the functions of the associated buttons on your meter’s display.

Symbol	Description	Actions
▶	Right arrow	Scroll right and display more menu items or move cursor one character to the right
▲	Up arrow	Exit screen and go up one level
▼	Small down arrow	Move cursor down the list of options or display more items below
▲	Small up arrow	Move cursor up the list of items or display more items above
◀	Left arrow	Move cursor one character to the left
+	Plus sign	Increase the highlighted value or show the next item in the list.
-	Minus sign	Show the previous item in the list

When you reach the last screen, press the right arrow again to cycle through the screen menus.

Meter screen menus overview

All meter screens are grouped logically, according to their function.

You can access any available meter screen by first selecting the Level 1 (top level) screen that contains it.

Level 1 screen menus - IEEE title [IEC title]

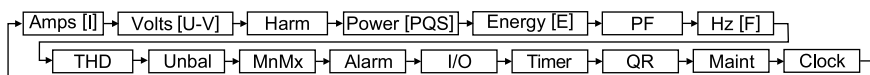

Menu tree

Use the menu tree to navigate to the setting you want to view or configure.

The image below summarizes the available meter screens (IEEE menus shown, with the corresponding IEC menus in parentheses).

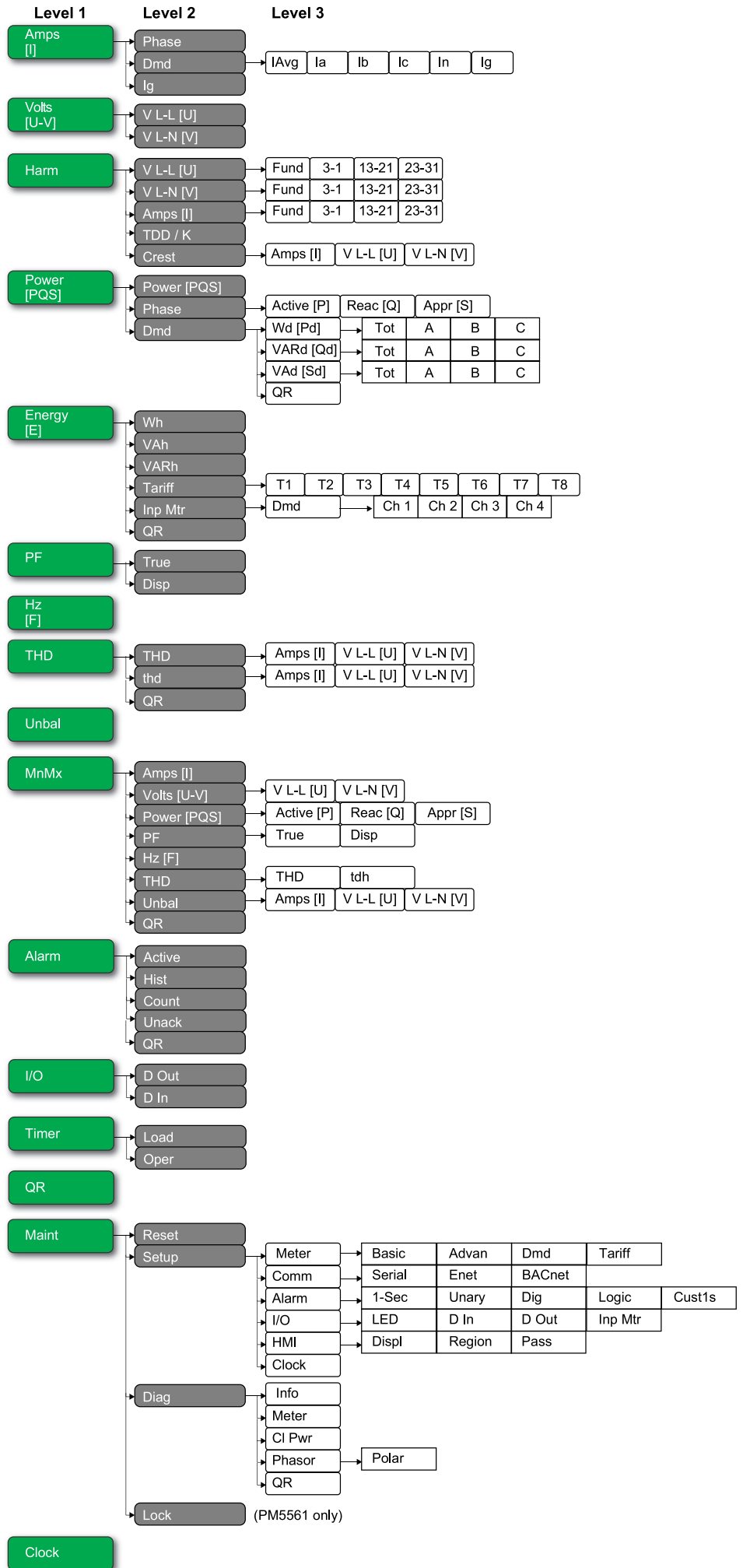

Related Topics

- Setting up regional settings

Data display screens

The meter display screens allow you to view meter values and configure settings.

The titles listed are for the HMI mode in IEEE, with the corresponding titles in IEC mode in square brackets [].

- Bulleted items indicate subscreens and their descriptions.

Current

Amps [I]

Amps Per Phase	Instantaneous current measurements for each phase and neutral (Ia [I1], Ib [I2], Ic [I3], In).
Dmd <ul style="list-style-type: none"> • Iavg, Ia [I1], Ib [I2], Ic [I3], In, Ig • Pk DT 	Summary of peak current demand values at the last demand interval for each phase and neutral (Ia [I1], Ib [I2], Ic [I3], In). <ul style="list-style-type: none"> • Real-time demand (Pres), peak demand (Peak) and predicted demand (Pred) for the present interval. Average demand for the previous (Last) interval. • Date and timestamp for the peak demand readings.
Ig	Average (Iavg), neutral (In) and residual/ground (Ig) current

Voltage

Volts [U-V]

Voltage L-L [U]	Line-to-line phase voltage (Vab [U12], Vbc [U23], Vca [U31]).
Voltage L-N [V]	Line-to-neutral phase voltage (Van [V1], Vbn [V2], Vcn [V3]).

Harmonics

Harm

Harmonics %	Graphical representation of harmonics (as a percent of fundamental).
V L-L [U] <ul style="list-style-type: none"> • Fundamental, 3-11, 13-21, 23-31 	Line-to-line voltage harmonics data: Numeric magnitude and angle for the fundamental harmonic, and graphical representation of harmonics for the 3rd to 11th, 13th to 21st, and 23rd to 31st odd harmonics for each line-to-line phase voltage (Vab [U12], Vbc [U23], Vca [U31]).
V L-N [V] <ul style="list-style-type: none"> • Fundamental, 3-11, 13-21, 23-31 	Line-to-neutral voltage harmonics data: Numeric magnitude and angle for the fundamental harmonic, and graphical representation of harmonics for the 3rd to 11th, 13th to 21st, and 23rd to 31st odd harmonics for each line-to-neutral phase voltage (Van [V1], Vbn [V2], Vcn [V3]).
Amps [I] <ul style="list-style-type: none"> • Fundamental, 3-11, 13-21, 23-31 	Current harmonics data: Numeric magnitude and angle for the fundamental harmonics, and graphical representation of harmonics for the 3rd to 11th, 13th to 21st, and 23rd to 31st odd harmonics for each phase current (Ia [I1], Ib [I2], Ic [I3]).
TDD/K	Total demand distortion and K-factor data for each phase voltage (K-F A [K-F 1], K-F B [K-F 2], K-F C [K-F 3]).
Crest <ul style="list-style-type: none"> • Amps [I], V L-L [U], V L-N [V] 	Crest factor data for each phase current (Ia [I1], Ib [I2], Ic [I3]), line-to-line phase voltage (Vab [U12], Vbc [U23], Vca [U31]), and line-to-neutral phase voltage (Van [V1], Vbn [V2], Vcn [V3]).

Power

Power [PQS]

Power Summary	Summary of real-time power consumption values for total active power in kW (Total [Ptot]), total reactive power in kVAR (Total [Qtot]), and total apparent power in kVA (Total [Stot]).
Phase • Active [P], Reac [Q], Appr [S]	Per phase and total power values for active power in kW (A [P1], B [P2], C [P3], Total [Ptot]), reactive power in kVAR (A [Q1], B [Q2], C [Q3], Total [Qtot]) and apparent power in kVA (A [S1], B [S2], C [S3], Total [Stot]).
Pwr Dmd Summary • Wd [Pd], VARd [Qd], VAd [Sd] • Tot, A [1], B [2], C [3] • Pk DT	Summary of peak power demand values in the previous (Last) demand interval period for active power in kW, reactive power in kVAR and apparent power in kVA. • Total and per phase peak power demand values in the previous (Last) demand interval for active power demand (Wd [P]), reactive power demand (VARd [Q]) and apparent power demand (VAd [S]). • For the selected power demand screen (active, reactive or apparent), each of these sub-screens (total and per phase demand) display demand values for the present demand (Pres) interval, predicted demand (Pred) based on the current power consumption rate, demand for the previous demand (Last) interval period, and recorded peak power demand (Peak) value. • Date and timestamp for the peak power demand (Peak) value.

Energy

Energy [E]

Wh, VAh, VARh	Delivered (Del), received (Rec), delivered plus received (D+R) and delivered minus received (D-R) accumulated values for active energy (Wh), apparent energy (VAh) and reactive energy (VARh).
Tariff • T1, T2, T3, T4, T5, T6, T7, T8 • Del • Rec • InMet	• Displays the available tariffs (T1 through T8). • Active energy delivered in Wh (W [P]), reactive energy delivered in VARh (VAR [Q]) and apparent energy delivered in VAh (VA [S]) energy for the selected tariff. • Active energy received in Wh (W [P]), reactive energy received in VARh (VAR [Q]) and apparent energy received in VAh (VA [S]) energy for the selected tariff • Accumulated values on the input metering channels (Ch 1 to Ch 4) for the selected tariff.
Inp Mtr • Dmd • Ch 1, Ch 2, Ch 3, Ch 4 • Pk DT	Accumulated values on the input metering channels (Ch 1 to Ch 4). • Summary of demand values for input metering channels Ch 1 to Ch 4 in the previous (Last) demand interval. • Demand values for present (Pres) and previous (Last) interval periods, predicted demand (Pred) based on the current consumption rate, and recorded peak demand (Peak) value for the selected input metering channel. • Date and timestamp for the peak demand reading.

Power Factor

PF

True	True power factor values per phase and total (PFa [PF1], PFb [PF2], PFc [PF3], Total), PF sign, and load type (capacitive = lead, inductive = lag).
Disp	Displacement power factor values per phase and total (PFa [PF1], PFb [PF2], PFc [PF3], Total), PF sign, and load type (capacitive = lead, inductive = lag).

Frequency

Hz [F]

Frequency (Freq), average voltage (Vavg), average current (Iavg) and total power factor (PF) values.
--

Total harmonic distortion

THD

THD • Amps [I], V L-L [U], V L-N [V]	THD (ratio of harmonic content to the fundamental) for phase currents (Ia [I1], Ib [I2], Ic [I3], In), line-to-line voltages (Vab [U12], Vbc [U23], Vca [U31]) and line-to-neutral voltages (Van [V1], Vbn [V2], Vcn [V3]).
thd • Amps [I], V L-L [U], V L-N [V]	thd (ratio of harmonic content to the rms value of total harmonic content) phase currents (Ia [I1], Ib [I2], Ic [I3], In), line-to-line voltages (Vab [U12], Vbc [U23], Vca [U31]) and line-to-neutral voltages (Van [V1], Vbn [V2], Vcn [V3]).

Unbalance

Unbal

Percent unbalance readings for line-to-line voltage (V L-L [U]), line-to-neutral voltage (V L-N [V]) and current (Amps [I]).
--

Minimum / maximum

MnMx

MnMx • Amps [I] • Volts [U-V] • V L-L [U], V L-N [V]	Summary of maximum values for line-to-line voltage, line-to-neutral voltage, phase current and total power. • Minimum and maximum values for phase current. • Minimum and maximum values for line-to-line voltage and line-to-neutral voltage.
Power [PQS] • Active [P], Reac [Q], Appr [S]	Minimum and maximum values for active, reactive, and apparent power.
PF • True, Disp	Minimum and maximum values for true and displacement PF and PF sign.
Hz [F]	Minimum and maximum values for frequency.
THD • THD, thd • Amps [I], V L-L [U], V L-N [V]	Minimum and maximum values for total harmonic distortion (THD or thd). • THD or thd minimum and maximum values for phase or neutral current, line-to-line voltage and line-to-neutral voltage.
Unbal • Amps [I], V L-L [U], V L-N [V]	Minimum and maximum values for current unbalance, line-to-line voltage unbalance and line-to-neutral voltage unbalance.

Alarm

Alarm

Active, Hist, Count, Unack	Lists all active alarms (Active), past alarms (Hist), the total number of times each standard alarm was tripped (Count), and all unacknowledged alarms (Unack).
----------------------------	---

Input / Output

I/O

D Out, D In	Current status (on or off) of the selected digital output or digital input. Counter shows the total number of times an off-to-on change of state is detected. Timer shows the total time (in seconds) that a digital input or digital output is in the on state.
-------------	--

Timer

Timer

Load	Real-time counter that keeps track of the total number of days, hours, minutes and seconds an active load is connected to the meter inputs.
Oper	Real-time counter for the total number of days, hours, minutes and seconds the meter has been powered.

Maintenance

Maint

Reset	Screens to perform global or single resets.
Setup <ul style="list-style-type: none"> Meter Basic, Adv, Dmd, Tariff 	Meter configuration screens. <ul style="list-style-type: none"> Basic: screens to define the power system and power system components/elements. Adv: screens to set up the active load timer and define the peak demand current for inclusion in TDD calculations. Dmd: screens to set up power demand, current demand and input metering demand. Tariff: screens to set up tariffs.
Com <ul style="list-style-type: none"> Serial, Enet 	Screens to set up serial and Ethernet communications.
Alarm <ul style="list-style-type: none"> 1-Sec, Unary, Dig, Logic, Cust1s 	Screens to set up standard (1-Sec), unary, digital, logic and custom (Cust1s) alarms.
I/O <ul style="list-style-type: none"> LED, D In, D Out, Inp Mtr 	Screens to set up the alarm / energy pulsing LED, digital outputs and input metering channels.
HMI <ul style="list-style-type: none"> Displ, Region, Pass 	Screens to configure display settings, edit regional settings and set up meter display access passwords.
Clock	Screens to set up the meter date and time.
Diag <ul style="list-style-type: none"> Info Meter Cl_Power Phasor Polar 	Diagnostic screens provide meter information for troubleshooting. <ul style="list-style-type: none"> Model, serial number, manufacture date, firmware (OS - operating system and RS - reset system) and language versions. OS CRC (cyclic redundancy check) is a number that identifies the uniqueness between different OS firmware versions — this parameter is only available on certain models (e.g., PM5561). Displays the meter status. Displays how many times the meter lost control power, and the date and time of its last occurrence. Displays a graphical representation of the power system the meter is monitoring. Displays the numeric magnitude and angles of all voltage and current phases.
Lock	Applies to PM5561. This locks or unlocks the MID protected quantities.

Clock

Clock

Meter date and time (local or GMT).

HMI setup screens

You can configure the meter’s display using the HMI setup screens.

The HMI (human-machine interface) setup screens allow you to:

- control the general appearance and behavior of the display screens,
- change the regional settings,
- change the meter passwords,

- enable or disable the QR code feature for accessing meter data.

See the *Meter Insights QR code feature quick start guide* for more information on accessing meter data using QR codes.

Setting up the display

You can change the display screen's settings, such as contrast, display and backlight timeout and QR code display.

1. Navigate to **Maint > Setup**.
2. Enter the setup password (default is "0"), then press **OK**.
3. Navigate to **HMI > Disp**.
4. Move the cursor to point to the parameter you want to modify, then press **Edit**.
5. Modify the parameter as required, then press **OK**.
6. Move the cursor to point to the next parameter you want to modify, press **Edit**, make your changes, then press **OK**.
7. Press the up arrow to exit.
8. Press **Yes** to save your changes.

Display settings available using the display

Parameter	Values	Description
Contrast	1 - 9	Increase or decrease the value to increase or decrease the display contrast.
Bcklght Timeout (min)	0 - 99	Set how long (in minutes) before the backlight turns off after a period of inactivity. Setting this to "0" disables the backlight timeout feature (i.e., backlight is always on).
Screen Timeout (min)	0 - 99	Set how long (in minutes) before the screen turns off after a period of inactivity. Setting this to "0" disables the screen timeout feature (i.e., display is always on).
QR Code	Enable, Disable	Set whether or not QR codes with embedded data are available on the display.

See the *Meter Insights QR code feature quick start guide* for more information on accessing meter data using QR codes.

To configure the display using ION Setup, see the "PM5500" topic in the ION Setup online help or in the ION Setup device configuration guide, available for download at www.schneider-electric.com.

Related Topics

- Setting up regional settings

Basic setup

Meter configuration can be performed directly through the display or remotely through software. See the section on a feature for instructions on configuring that feature (for example, see the Communications section for instructions on configuring Ethernet communications).

Configuring basic setup parameters using the display

You can configure basic meter parameters using the display.

Proper configuration of the meter's basic setup parameters is essential for accurate measurement and calculations. Use the Basic Setup screen to define the electrical power system that the meter is monitoring.

If standard (1-sec) alarms have been configured and you make subsequent changes to the meter's basic setup, all alarms are disabled to prevent undesired alarm operation.

NOTICE

UNINTENDED EQUIPMENT OPERATION

- Verify all standard alarms settings are correct and make adjustments as necessary.
- Re-enable all configured alarms.

Failure to follow these instructions can result in equipment damage.

After saving the changes, confirm all configured standard alarm settings are still valid, reconfigure them as required, and re-enable the alarms.

1. Navigate to **Maint > Setup**.
2. Enter the setup password (default is "0"), then press **OK**.
3. Navigate to **Meter > Basic**.
4. Move the cursor to point to the parameter you want to modify, then press **Edit**.
5. Modify the parameter as required, then press **OK**.
6. Move the cursor to point to the next parameter you want to modify, press **Edit**, make your changes, then press **OK**.

7. Press **Yes** to save your changes.**Basic setup parameters available using the display**

Values	Description
Power System	
Select the power system type (power transformer) the meter is wired to.	
1PH2W LN	Single-phase 2-wire line-to-neutral
1PH2W LL	Single-phase 2-wire line-to-line
1PH3W LL with N	Single-phase 3-wire line-to-line with neutral
3PH3W Dlt Ungnd	3-phase 3-wire ungrounded delta
3PH3W Dlt Cmr Gnd	3-phase 3-wire corner grounded delta
3PH3W Wye Ungnd	3-phase 3-wire ungrounded wye
3PH3W Wye Gnd	3-phase 3-wire grounded wye
3PH3W Wye Res Gnd	3-phase 3-wire resistance-grounded wye
3PH4W Opn Dlt Ctr Tp	3-phase 4-wire center-tapped open delta
3PH4W Dlt Ctr Tp	3-phase 4-wire center-tapped delta
3PH4W Wye Ungnd	3-phase 4-wire ungrounded wye
3PH4W Wye Gnd	3-phase 4-wire grounded wye
3PH4W Wye Res Gnd	3-phase 4-wire resistance-grounded wye
VT Connect	
Select how many voltage transformers (VT) are connected to the electrical power system.	
Direct Con	Direct connect; no VTs used
2VT	2 voltage transformers
3VT	3 voltage transformers
VT Primary (V)	
1 to 1,000,000	Enter the size of the VT primary, in Volts.
VT Secondary (V)	
100, 110, 115, 120	Select the size of the VT secondary, in Volts.
CT on Terminal	
Define how many current transformers (CT) are connected to the meter, and which terminals they are connected to.	
I1	1 CT connected to I1 terminal
I2	1 CT connected to I2 terminal
I3	1 CT connected to I3 terminal
I1 I2	2 CT connected to I1, I2 terminals
I1 I3	2 CT connected to I1, I3 terminals
I2 I3	2 CT connected to I2, I3 terminals
I1 I2 I3	3 CT connected to I1, I2, I3 terminals
I1 I2 I3 IN	4 CT connected to I1, I2, I3, IN terminals
CT Primary (A)	
1 to 1000000	Enter the size of the CT primary, in Amps.
CT Secondary (A)	
1, 5	Select the size of the CT secondary, in Amps.
CT Primary Neu. (A)	
1 to 32767	This parameter displays when CT on Terminal is set to I1,I2,I3, IN. Enter the size of the 4th (Neutral) CT primary, in Amps.
CT Sec. Neu. (A)	

Basic setup parameters available using the display

Values	Description
1, 5	This parameter displays when CT on Terminal is set to I1,I2,I3, IN. Select the size of the 4th (Neutral) CT secondary, in Amps.
Sys Frequency (Hz)	
50, 60	Select the frequency of the electrical power system, in Hz.
Phase Rotation	
ABC, CBA	Select the phase rotation of the 3-phase system.

Related Topics

- Balanced system considerations

Configuring advanced setup parameters using the display

You can configure a subset of advanced parameters using the display.

- Navigate to **Maint > Setup**.
- Enter the setup password (default is "0"), then press **OK**.
- Navigate to **Meter > Advan**.
- Move the cursor to point to the parameter you want to modify, then press **Edit**.
- Modify the parameter as required, then press **OK**.
- Move the cursor to point to the next parameter you want to modify, press **Edit**, make your changes, then press **OK**.
- Press **Yes** to save your changes.

Advanced setup parameters available using the display

Parameter	Values	Description
Label	—	This label identifies the device, e.g., "Power Meter". You cannot use the display to edit this parameter. Use ION Setup to change the device label.
Load Timer Setpt (A)	0 - 9	Specifies the minimum average current at the load before the timer starts. The meter begins counting the number of seconds the load timer is on (i.e., whenever the readings are equal to or above this average current threshold).
Pk I dmd for TDD (A)	0 - 9	Specifies the minimum peak current demand at the load for inclusion in total demand distortion (TDD) calculations. If the load current is below the minimum peak current demand threshold, the meter does not use the readings to calculate TDD. Set this to "0" (zero) if you want the power meter to use the metered peak current demand for this calculation.

Related Topics

- TDD calculations

Setting up regional settings

You can change the regional settings to localize the meter screens and display data in a different language, using local standards and conventions.

NOTE: In order to display a different language other than those listed in the Language setup parameter, you need to download the appropriate language file to the meter using the firmware upgrade process.

1. Navigate to **Maint > Setup**.
2. Enter the setup password (default is "0"), then press **OK**.
3. Navigate to **HMI > Region**.
4. Move the cursor to point to the parameter you want to modify, then press **Edit**.
5. Modify the parameter as required, then press **OK**.
6. Move the cursor to point to the next parameter you want to modify, press **Edit**, make your changes, then press **OK**.
7. Press the up arrow to exit.
8. Press **Yes** to save your changes.

Regional settings available using the display

Parameter	Values	Description
Language	English US, French, Spanish, German, Italian, Portuguese, Chinese, Russian	Select the language you want the meter to display.
Date Format	MM/DD/YY, YY/MM/DD, DD/MM/YY	Set how you want the date to be displayed, e.g., month/day/year.
Time Format	24Hr, AM/PM	Set how you want the time to be displayed, e.g., 17:00:00 or 5:00:00 PM.
HMI Mode	IEC, IEEE	Select the standards convention used to display menu names or meter data.

Related Topics

- Meter display language
- Firmware upgrades

Resetting the display language

To reset the meter to the default language (English), press and hold the outermost two buttons for 5 seconds.

Setting up the screen passwords

It is recommended that you change the default password in order to prevent unauthorized personnel from accessing password-protected screens such as the diagnostics and reset screens.

This can only be configured through the front panel. The factory-default setting for all passwords is "0" (zero).

If you lose your password, you must return the meter for factory reconfiguration, which resets your device to its factory defaults and destroys all logged data.

NOTICE
IRRECOVERABLE PASSWORD
Record your device's user and password information in a secure location.
Failure to follow these instructions can result in data loss.

1. Navigate to **Maint > Setup**.
2. Enter the setup password (default is "0"), then press **OK**.

3. Navigate to **HMI > Pass**.
4. Move the cursor to point to the parameter you want to modify, then press **Edit**.

Parameter	Values	Description
Setup	0000 - 9999	Sets the password for accessing the meter setup screens (Maint > Setup).
Energy Resets	0000 - 9999	Sets the password for resetting the meter's accumulated energy values.
Demand Resets	0000 - 9999	Sets the password for resetting the meter's recorded peak demand values.
Min/Max Resets	0000 - 9999	Sets the password for resetting the meter's recorded minimum and maximum values.

5. Modify the parameter as required, then press **OK**.
6. Move the cursor to point to the next parameter you want to modify, press **Edit**, make your changes, then press **OK**.
7. Press the up arrow to exit.
8. Press **Yes** to save your changes.

Related Topics

- Password best practices

Setting the clock

The Clock setup screens allow you to set the meter's date and time.

NOTE: You must always set or sync the meter time to UTC (GMT, Greenwich Mean Time), not local time. Use the **GMT Offset (h)** setup parameter to display the correct local time on the meter.

1. Navigate to **Maint > Setup**.
2. Enter the setup password (default is "0"), then press **OK**.
3. Navigate to **Clock**.
4. Move the cursor to point to the parameter you want to modify, then press **Edit**.
5. Modify the parameter as required, then press **OK**.
6. Move the cursor to point to the next parameter you want to modify, press **Edit**, make your changes, then press **OK**.
7. Press the up arrow to exit.

8. Press **Yes** to save your changes.

Parameter	Values	Description
Date	DD/MM/YY, MM/DD/YY, YY/MM/DD	Set the current date using the format displayed on screen, where DD = day, MM = month and YY = year.
Time	HH:MM:SS (24 hour format), HH:MM:SS AM or PM	Use the 24-hour format to set the current time in UTC (GMT).
Meter Time	GMT, Local	Select GMT to display the current time in UTC (Greenwich Mean Time zone). To display local time, set this parameter to Local, then use GMT Offset (h) to display local time in the proper time zone.
GMT Offset (h) ¹	+/- HH.0	Available only when Meter Time is set to Local, use this to display the local time relative to GMT. Set the sign to plus (+) if local time is ahead of GMT, or minus (-) if local time is behind GMT.

¹ Currently supports whole integers only.

To configure the clock using ION Setup, see the “PM5500” topic in the ION Setup online help or in the ION Setup device configuration guide, available for download at www.schneider-electric.com.

Security

Security overview

Your Schneider Electric product is equipped with security-enabling features.

These features arrive in a default state and can be configured for your installation needs. Please note that disabling or modifying settings within the scope of these individual features can impact the overall security robustness of the device and ultimately the security posture of your network in either positive or negative ways. Review the security intent and recommendations for the optimal use of your device's security features.

Products are hardened to increase security robustness. This is an ongoing process consisting of secure development practices, inclusion of security features and testing at our security test facilities. Following system hardening best practices is also necessary to help ensure your overall system security.

Security features on your meter

Your meter comes with security features that you can configure to help protect against unauthorized configuration and access to your meter's data through the meter's display or communications.

Passwords and user accounts

The meter has configurable passwords for the display and configurable usernames, user groups and passwords for the webpages and FTP server.

Leaving the usernames and passwords at the default values makes it easier for a potential attacker to gain unauthorized access to your device. It is recommended that you change your passwords and usernames from the default values.

Related Topics

- Password best practices
- Setting up the screen passwords
- Configuring user accounts for webpages

Ethernet communications security

You can enable and disable communications using certain Ethernet protocols and set the port numbers used for those protocols.

Leaving unused ports open provides additional attack surfaces for a potential attacker. Minimizing the number of entry points into a device reduces the likelihood of unauthorized intrusions.

Your device ships with Ethernet communications enabled on port 80 (HTTP) with Modbus TCP/IP and BACnet/IP, FTP and SNMP protocols enabled by default. It is recommended that you disable any unused protocols.

SNTP (used for time synchronization) and SMTP (used by the device to send outgoing emails only) are disabled by default.

Related Topics

- Ethernet communications

Modbus TCP/IP filtering

The Modbus TCP/IP filtering feature controls which IP addresses are allowed to communicate with the device using Modbus TCP/IP.

Minimizing the number of IP address that can access the device reduces the likelihood of unauthorized intrusions.

This feature is disabled by default. It is recommended that you enable this feature, if your system architecture permits.

Related Topics

- Modbus TCP/IP filtering

Revenue and billing security features

Selected meter models support additional hardware and firmware locking to prevent unauthorized access to revenue-related parameters and settings.

Related Topics

- MID overview

Security configuration recommendations

There are recommended security configuration settings to help improve security on your meter.

- Make sure you change your meter's display and webpages / FTP server password and user account settings from the defaults.

Password best practices

There are recommended password best practices to help improve security on your meter.

- Change your meter's display (front panel) password from the default value.
- Make your meter's display and user-specific passwords as complex as possible.

NOTE: Make sure that the user password you enter is compatible with the software used to communicate with your device.

- Schedule regular changes to your meter's display and user passwords.
- Record your meter's display and user passwords in a secure location.

If your meter's user access information is lost, you must return the meter to the factory, where your meter is reset to its factory defaults and all logged data is lost.

NOTICE

DATA LOSS

Record your device's user and password information in a secure location.

Failure to follow these instructions can result in equipment damage.

Meter webpages

Webpages overview

The meter’s Ethernet connection allows you to access the meter so you can view data and perform some basic configuration and data export tasks using a web browser.

⚠ WARNING

INACCURATE DATA RESULTS

- Do not rely solely on data displayed on the display or in software to determine if this device is functioning correctly or complying with all applicable standards.
- Do not use data displayed on the display or in software as a substitute for proper workplace practices or equipment maintenance.

Failure to follow these instructions can result in death, serious injury, or equipment damage.

Webpages interface

Your meter comes with default webpages.

The graphic below is a representative sample that shows the typical elements. Your meter’s webpages may appear differently than shown.

A	Meter brand and model	D	Webpage menu	
B	Username	E	Webpage content	
C	Main menus	F	Show/hide toggle	

Accessing the meter webpages

Access the meter’s webpages to view data and perform basic configuration and data export tasks using a web browser.

The webpages are accessed through the meter’s Ethernet port so it must be configured properly.

1. Open a web browser and enter the meter’s IP address in the address box.
2. Enter your username and password.
 The username and password for the default user accounts are user1 / pass1 and user2 / pass2.
3. Use the menus and tabs to select and display the meter’s various webpages.
4. Click the up / down arrows to show and hide sections of the webpages and menus.
5. Click **Logout** to exit the meter webpages.

Default webpages

The meter has a comprehensive set of default webpages that enable you to view basic energy and power quality values, I/O and alarm information, and data and maintenance logs.

In addition, you can use the webpages to configure a variety of settings.

You can also create custom webpages and load them into the www folder on your meter’s internal FTP server.

Monitoring

This tab allows you to navigate to the following webpages:

Webpage	Description
Basic Readings	<ul style="list-style-type: none"> • Basic readings such as Load Current, Power and Voltage in gauge and table display • Demand current and demand power values, including last, present and peak • Accumulated energy values and the date/time of the last reset
Power Quality	THD and unbalance values for current and voltage
Active Alarms ¹	This is a list of active (unacknowledged) alarm events with a date/ timestamp for each event, the value that triggered the alarm (e.g., pickup) and a description of the event type.
Alarm History ¹	This is a historical list of (acknowledged) alarm events with a date/ timestamp for each event, the value that triggered the alarm (e.g., pickup) and a description of the event type.
Inputs/Outputs	Displays the current status of the digital inputs and outputs.
Data Log	A list of timestamped data recorded in the meter’s data log (energy delivered in Wh, VARh and VAh).

¹ Click the event number to display additional details about the alarm, for example, the actual pickup or dropout value and which phase the alarm condition occurred.

Diagnostics

This tab allows you to view the following webpages:

Webpage	Description
Meter Information	Displays the meter model, serial number and manufacture date in addition to information on the version numbers of the installed firmware (OS, RS, Ethernet, Language and FPGA)
Communications ¹	Contains diagnostics information for Ethernet, HTTP server, HTTP client, Modbus server and SMTP server to aid in troubleshooting communications. Displays the meter’s current time and the meter’s last boot time.

Webpage	Description
Registers	Allows you to read a specified block of Modbus registers from the meter or from a slave device when the meter is acting as a gateway.

¹ Click **Reset** to clear the stored information on this page.

Maintenance

This tab allows you to view the Maintenance Log webpage.

The Maintenance Log page displays a record of meter events, and in particular, changes to meter setup. Each event is date/timestamped. The **Event Type** field provides a brief description of what changed and the **Event Cause** specifies what triggered the event..

Related Topics

- Reading device registers using the webpages

Setting the measurement range for basic parameters

You can set the ranges that appear on the gauges that display on the **Basic Readings** webpage.

You must be logged in as a web master or product master to change the ranges.

1. Click **Set Range**.
2. Set the ranges for the gauges:
 - Type the minimum and maximum ratings (limits) for current, power and voltage (L-L and L-N), or
 - Set **Enable Auto Scale** to automatically set the scale on the gauges.
3. Click **Save Changes**.

User accounts

Default login accounts

The meter has a set of default login credentials to access the webpages and ftp server.

The following login credentials are configured by default:

Username	Password	User group
user1	pass1	Web Master
user2	pass2	Product Master

It is recommended that you change the default passwords to prevent unauthorized access.

User groups

Webpages and ftp server access permissions are based on user groups.

User group	Access
Web user	Users in this group can view all information that is displayed on the webpages. In addition, a web user can view most device settings available through the webpages (except user accounts) but cannot change them.
Web master	Users in this group can view all information that is displayed on the webpages. In addition, a web master can change device settings available on the webpages but cannot see or edit user accounts.
Product master	Users in this group can view all information that is displayed on the webpages. In addition, a product master can change device settings available on the webpages, including user accounts. The product master can also access the meter using the FTP server.

Configuring user accounts for webpages

You can setup user accounts for access to the meter's using the webpages or FTP, assign users to a group that determines what each user can access, and set the webpage display language for each user.

You must be logged in as a Product Master to configure user accounts.

NOTE: If you lose your meter's webpage user access information, contact Technical Support.

1. Click **Settings > User Accounts**.
2. Configure the parameters as appropriate for each user.
3. Click **Save changes** to send and save the new settings to the meter.

User account settings available using the webpages

Parameter	Description
Name	Lists the current usernames for accessing the meter. You can add a new user by typing the username in a blank cell. To remove an existing user, select the name and press DELETE on your keyboard.
Password ¹	Lists the current password associated with each user. After adding a new username, type a password to associate it with the username. As you enter characters for your password, the status bar changes to indicate the password strength (weak, medium, strong or very strong). Re-type the password in the Confirm Password field.
Group	Select the group the username belongs to: <ul style="list-style-type: none"> • Web User • Web Master • Product Master NOTE: You must have at least one Web Master and one Product Master. User 1 must be a Web Master and user 2 must be a Product Master.
Language	Select the language the webpages are displayed in for the selected username.

¹ Always record changes or additions to the username and password list and store the list in a safe place.

Related Topics

- Password best practices

Reading device registers using the webpages

You can use the webpages to read a specified block of Modbus registers from the meter or from a slave device when the meter is acting as a gateway.

1. Navigate to **Diagnostics > Registers > Read Device Registers**.
2. Type the address of the device you want to read in the **Device ID** field.
3. Enter values in the **Starting Register** and **Number of Registers** fields.
4. Select data format of the registers you want to read from the **Data Type** field.
5. Select the number format that you want to display the value of the registers in: Decimal, Hexadecimal, Binary, ASCII or Float.
6. Click **Read**.

Go to www.schneider-electric.com and search for your meter's Modbus register list to download a copy.

Communications

Ethernet communications

The meter supports Modbus TCP, BACnet/IP, HTTP, SNMP, SMTP and FTP protocols and can communicate at data speeds up to 100 Mbps through its Ethernet communications port.

The meter supports a single IP address between two 10/100Base-T Ethernet ports. The second Ethernet port functions as an Ethernet switch, which allows you to have shorter Ethernet cable runs between the meters without requiring additional Ethernet routers or repeaters. This helps simplify network connections and reduce installation time and costs.

The meter supports a maximum of 128 concurrent TCP/IP connections, that are shared between HTTP, FTP, Modbus TCP and other TCP/IP protocols. A maximum of 20 HTTP connections are supported.

Ethernet configuration

In order to use Ethernet communications, you must configure your device's IP address; you must also configure the subnet and gateway information if required by your network.

NOTE: For meters that do not have a display, you must configure each one separately in order to set a unique IP address for each device.

You need to enter network information for any Ethernet servers used by the device.

NOTE: Contact your network system administrator for your IP address and other Ethernet network configuration values.

Configure your device's Ethernet settings by using the display or directly connecting to your meter and using a web browser to access the device's webpages. Modify your meter's Ethernet settings to those provided by your network system administrator before connecting the device to your local area network (LAN).

After the meter's Ethernet port is configured and connected to the LAN, you can use ION Setup to configure other meter setup parameters.

Ethernet port setup

The meter is factory-configured with default Ethernet communications settings.

You must modify the default Ethernet settings before connecting the meter to your local area network (LAN) using the meter webpages.

The default Ethernet communications settings are:

- IP address = 169.254.0.10
- Subnet mask = 255.255.0.0
- Gateway = 0.0.0.0
- HTTP server = Enabled
- Device name = PM55-#xxxxxxxxx, where xxxxxxxxxxx is the meter's factory serial number (with leading zeros if serial number is less than 10 characters)
- IP method = Stored

NOTE: Your meter's serial communications port ID (**Com1 ID**) is used in both Ethernet and serial communications; you need to change the **Com1 ID** meter property in ION Setup if you modify the meter's RS-485 address.

Performing initial Ethernet configuration using the webpages

The meter is factory-configured with default Ethernet settings, which you must change before connecting the meter to your network.

For meters with a display, you can configure basic Ethernet settings using the display. If you want to use Ethernet to communicate to meters without a display, you need to perform the following steps to configure basic Ethernet settings before you connect the meter to your network.

1. Disconnect your computer from the network. If your computer has wireless communications, make sure you disable the wireless network connection as well.

NOTE: After you disconnect your computer from the network, its IP address should automatically update to a default IP address of 169.254.###.### (where ### equals a number from 0 to 255) and a subnet mask of 255.255.0.0. If your computer does not automatically update after several minutes, contact your network administrator to set up a static IP address.

2. Use an Ethernet cable to connect the computer to one of the meter’s Ethernet ports.
3. Open a web browser and enter 169.254.0.10 in the address field.
4. Log in to the meter webpages.

The default login credentials are:

Username	Password
user1	pass1
user2	pass2

5. Click **Settings > Ethernet Settings**.
6. Modify the Ethernet setup parameters with the settings your system administrator assigned for the meter.

Parameter	Description
MAC Address	Displays the meter’s factory-programmed MAC address. This information is read-only and cannot be changed.
IP Address Acquisition Mode	This controls the network protocol for your device (which the meter uses to obtain its IP address): <ul style="list-style-type: none"> • DHCP: Dynamic Host Configuration Protocol • BOOTp: Bootstrap Protocol – Static: Use the static value programmed in the IP Address setup register • Default: Use 85.16 as the first two values of the IP address, then convert the last two hexadecimal values of the MAC address to decimal and use this as the last two values of the IP address Example: MAC address = 00:80:67:82:B8:C8 Default IP address = 85.16.184.200
IP Address	The Internet protocol address of your device.
Subnet Mask	The Ethernet IP subnetwork address of your network.
Default Gateway	The Ethernet IP gateway address of your network.

7. Click **Save** changes to send and save the new settings to the meter.
8. Click **Logout** to exit the meter’s webpages.
9. Re-establish the computer’s connection to your LAN (plug the computer’s Ethernet cable back to your LAN connection or re-enable wireless communications to the LAN).

Setting up Ethernet communications using the display

The Ethernet setup screen allows you to assign the meter a unique IP address so you can use software to access the meter’s data or configure the meter remotely through the Ethernet port.

Before configuring the Ethernet parameters, make sure you obtain your meter’s IP address information from your network administrator or IT department.

1. Navigate to **Maint > Setup**.
2. Enter the setup password (default is “0”), then press **OK**.
3. Navigate to **Comm > Enet**.
4. Move the cursor to point to the parameter you want to modify, then press **Edit**.
5. Modify the parameter as required, then press **OK**.
6. Move the cursor to point to the next parameter you want to modify, press **Edit**, make your changes, then press **OK**.
7. Press the up arrow to exit.
8. Press **Yes** to save your changes.

Parameter	Values	Description
IP Method	Stored, Default, DHCP, BOOTP	This controls the network protocol for your device (what the meter uses to obtain its IP address). Stored: Use the static value programmed in the IP Address setup register Default: Use 85.16 as the first two values of the IP address, then convert the last two hexadecimal values of the MAC address to decimal and use this as the last two values of the IP address. Example: MAC address = 00:80:67:82:B8:C8 Default IP = 85.16.184.200 DHCP: Dynamic Host Configuration Protocol BOOTP: Bootstrap Protocol
IP Address	Contact your local network administrator for parameter values.	The Internet protocol address of your device.
Subnet	Contact your local network administrator for parameter values.	The Ethernet IP subnetwork address of your network (subnet mask).
Gateway	Contact your local network administrator for parameter values.	The Ethernet IP gateway address of your network.
HTTP Server	Enabled, Disabled	Controls whether your device’s webserver and webpages are active or not.
Device Name	(see description)	This is the meter’s device name and is factory set to PM55#-xxx (where xxx is the serial number of the meter). This can be used as a DNS entry that maps the device name to the IP address assigned by the DHCP server.

NOTE:

An exclamation mark beside the IP address can indicate:

- that the IP address is being programmed. Wait a few seconds for the IP address to appear to confirm that it is programmed.
- that there is a problem with the network. Check with your system administrator for network issues.

Configuring basic Ethernet settings using the webpages

You can use the meter’s webpages to configure Ethernet settings.

1. Log in to the meter webpages using Product Master or Web Master credentials.
2. Click **Settings > Ethernet Settings**.
3. Modify the Ethernet setup parameters as required.
4. Click **Save changes** to send and save the new settings to the meter.

Parameter	Description
MAC Address	Displays the meter’s factory-programmed MAC address. This information is read-only and cannot be changed.
IP Address Acquisition Mode	<p>This controls the network protocol for your device (which the meter uses to obtain its IP address):</p> <ul style="list-style-type: none"> • DHCP: Dynamic Host Configuration Protocol NOTE: Fully qualified domain names are not supported. The device name is not automatically sent to a DNS server when a DHCP request is sent. In order to use device name instead of IP address, your IT administrator must manually add the device name to the DNS. • BOOTP: Bootstrap Protocol • Stored: The static value you programmed in the IP Address setup register • Default: Uses 85.16 as the first two values of the IP address, then converts the last two hexadecimal values of the MAC address to decimal and uses this as the last two values of the IP address. Example: MAC address = 00:80:67:82:B8:C8, default IP = 85.16.184.200
IP Address	The Internet protocol address of your device.
Subnet Mask	The Ethernet IP subnetwork address of your network (subnet mask).
Default Gateway	The Ethernet IP gateway address of your network.

Configuring advanced Ethernet parameters using the webpages

You can configure advanced Ethernet parameters, such as TCP keepalive, connection timeouts and idle times, using the Advanced Ethernet Settings webpage.

1. Log in to the meter webpages using Product Master or Web Master credentials.
2. Click **Settings > Advanced Ethernet Settings**.
3. Modify the Ethernet setup parameters as required.

- Click **Save changes** to send and save the new settings to the meter.

Parameter	Values	Description
Time to Live	1-255	The maximum number of hops (in other words, devices such as routers) that a TCP packet is allowed to pass through before it is discarded
TCP keepalive	0-65000	How frequently (in seconds) the meter sends a TCP keepalive packet. A setting of 0 disables the sending of TCP keepalive packets.
BootP Timeout	0-60	The length of time (in seconds) that the meter waits for a response from a BootP server (the default IP address is used after timeout if no IP address is assigned.)
ARP Cache Timeout	0-65000	The length of time (in seconds) that ARP entries are kept in the ARP cache
FTP Server	Enabled, Disabled	Enables or disables the meter's internal FTP server
FTP Connection Idle Time	30-900	The length of time (in seconds) after which an idle FTP connection is closed
HTTP Connection Idle Time	0-65000	The length of time (in seconds) after which an idle HTTP connection is closed
HTTP Port Number	80, 1024- 65000	The TCP port used for HTTP messages. The following port numbers are reserved for other network protocols and cannot be used: 20 / 21 (FTP), 161 / 162 (SNMP) and 502 (Modbus TCP/IP).
HTTP Maximum Keepalives	0-65000	The number of times the meter sends a keepalive signal if it does not receive a response
Modbus TCP/IP Server Connections	16, 32, 36, 40, 44, 48, 64	The number of TCP connections used for Modbus TCP communications when the meter is functioning as an Ethernet gateway
Modbus TCP/IP Server Connection Idle Time	0-32767	The length of time the meter waits for a Modbus TCP/IP device to respond to a connection request initiated by the meter.

Using a serial communications converter to set up RS-485

You can use a communications converter (USB to RS-485 or RS-232 to RS-485) to connect to the meter.

NOTE: Configuring the serial communications settings using this method may cause ION Setup to lose communications when the changes are sent to your meter. You must reconfigure ION Setup to match the new settings to re-establish communications with your meter.

- Configure the serial communications converter's settings to be compatible with the meter's default communications settings.
- Connect the meter's RS-485 port to the serial communications converter.
- Connect the communications converter to the computer.
- Start ION Setup in Network mode.
- Add a serial site and set its properties:
 - Comm link = Serial
 - Comm port = select which serial (or USB) port the communications converter is attached to
 - Baud rate = 19200
 - Format = select a format with even parity

6. Add a meter to the site and set its properties:
 - Type = PowerLogic™ PM5500 power meter
 - Unit ID = 1
7. Use the setup screens to modify the meter’s setup parameters.
8. Use the **RS-485 Base Comm** setup screen to modify the meter’s serial communication settings.
9. Click **Send** to save your changes to the meter. You need to reconfigure ION Setup to match the changed settings in order to re-establish communications with your meter.

NOTE: If you set the protocol to ASCII 7, ASCII 8 or JBus, you cannot use ION Setup to reconnect to the meter – ION Setup does not communicate using these protocols.

10. Exit ION Setup.

RS-485 port settings

Parameter	Values	Description
Protocol	Modbus RTU, JBus, ASCII 8, ASCII 7	Select the communications format used to transmit data. The protocol must be the same for all devices in a communications loop. ION Setup does not support ASCII 8, ASCII 7 or JBus protocols.
Address	1 to 247	Set the address for this device. The address must be unique for each device in a communications loop. For JBus protocol, set the device ID to 255. This value is used in both Modbus TCP/IP and serial communications.
Baud rate	9600, 10200, 38400	Select the speed for data transmission. The baud rate must be the same for all devices in a communications loop.
Parity	Even, Odd, None	Select None if the parity bit is not used. The parity setting must be the same for all devices in a communications loop.

Serial communications

The meter supports serial communication through the RS-485 port.

In an RS-485 network, there is one master device, typically an Ethernet to RS-485 gateway. It provides the means for RS-485 communications with multiple slave devices (for example, meters). For applications that require only one dedicated computer to communicate with the slave devices, a USB to RS-485 converter can be used to connect to the master device.

Up to 32 devices can be connected on a single RS-485 bus.

RS-485 network configuration

After you have wired the RS-485 port and powered up the meter, you must configure the serial communications port in order to communicate with the meter.

Each device on the same RS-485 communications bus must have a unique address and all connected devices must be set to the same protocol, baud rate, and parity (data format).

NOTE: To communicate with the meter using ION Setup, you must set the serial site and all connected devices in the RS-485 network to the same parity setting.

For meters that do not have a display, you must first wire and configure each one separately before connecting these meters to the same RS-485 bus.

RS-485 port setup

The meter is factory-configured with default serial communications settings that you may need to modify before connecting the meter to the RS-485 bus.

The meter is factory-configured with the following default serial communications settings:

- Protocol = Modbus RTU
- Address = 1
- Baud rate = 19200
- Parity = Even

You can use a communications converter (USB to RS-485 or RS-232 to RS-485) or Ethernet gateway device to connect to the meter.

NOTE: Your meter’s serial communications port ID (Com1 ID) is used in both Ethernet and serial communications; you need to change the Com1 ID meter property in ION Setup if you modify the meter’s RS-485 address.

Setting up serial communications using the display

The Serial setup screen allows you to configure the meter’s RS-485 communications port so you can use software to access the meter’s data or configure the meter remotely.

1. Navigate to **Maint > Setup**.
2. Enter the setup password (default is “0”), then press **OK**.
3. Navigate to **Comm > Serial**.
4. Move the cursor to point to the parameter you want to modify, then press **Edit**.
5. Modify the parameter as required, then press **OK**.
6. Move the cursor to point to the next parameter you want to modify, press **Edit**, make your changes, then press **OK**.
7. Press the up arrow to exit. Press **Yes** to save your changes.

Parameter	Values	Description
Mode	Slave, Gateway	Set this to Gateway to enable the Ethernet gateway functionality. Set this to Slave if you are adding the meter as a downstream device to an RS-485 network.
Protocol	Modbus, Jbus, ASCII 8 Bit, ASCII 7 Bit	Select the communications format used to transmit data. The protocol must be the same for all devices in a communications loop.
Address	1 to 247	Set the address for this device. The address must be unique for each device in a communications loop. For Jbus protocol, set the device ID to 255.
Baud Rate	9600, 19200, 38400	Select the speed for data transmission. The baud rate must be the same for all devices in a communications loop.
Parity	Even, Odd, None	Select None if the parity bit is not used. The parity setting must be the same for all devices in a communications loop.

Configuring serial settings using the webpages

The Serial Settings webpage allows you to configure the meter’s RS-485 communications.

1. Log in to the meter webpages using Product Master or Web Master credentials.
2. Click **Settings > Serial Settings**.
3. Modify the serial settings as required.

4. Click **Save changes**.

NOTE: Click **Defaults** to reset the advanced serial port settings to their default values.

Parameter	Values	Description
Mode	Slave, Gateway	Set this to Gateway to enable the Ethernet gateway functionality. Set this to Slave if you are adding the meter as a downstream device to an RS-485 network.
Protocol	Modbus, Jbus, ASCII 8 Bit, ASCII 7 Bit	Select the communications format used to transmit data. The protocol must be the same for all devices in a communications loop. NOTE: The protocol must be set to Modbus RTU or JBus if you are using the meter as an Ethernet gateway.
Address	1 to 247	Set the address for this device. The address must be unique for each device in a communications loop.
Baud Rate	9600, 19200, 38400	Select the speed for data transmission. The baud rate must be the same for all devices in a communications loop.
Parity	Even, Odd, None	Select None if the parity bit is not used. The parity setting must be the same for all devices in a communications loop.
Modbus Broadcast	Enabled, Disabled	Set this to Enabled to if you want the gateway meter to forward broadcast messages (sent to Unit ID 0) to the downstream serial devices.
Response Timeout ¹	0.1, 0.2, 0.3, 0.4, 0.5, 1, 2, 3, 4, 5, 6, 7, 8, 9, 10	Set the time the gateway meter waits for an answer from a downstream serial device before generating an exception response.
Delay Between Frames ¹	0, 10, 20, 30, 40, 50, 60, 70, 80, 90, 100	The minimum time in milliseconds between the end of a received response and the beginning of a new request. Set this parameter to help improve communications between the gateway and downstream slave devices with slower response times.
Silent Interval Extension ¹	0 – 15	Set this parameter to extend the silent interval (used to mark the end of a Modbus packet) beyond the default 3.5 characters defined in the Modbus standard. After the defined character time elapses without a new character, the gateway meter treats the next character as the start of a new message.
¹ These are advanced settings that you can adjust if you have communications errors when communicating through the gateway to the downstream serial devices. They only apply if the meter is functioning as a gateway, and you should only change these settings if you have an advanced knowledge of Modbus communications and your communications network.		

Using an Ethernet gateway to set up RS-485

You can use an Ethernet gateway to connect to the meter and configure RS-485 settings.

NOTE: Configuring the serial communications settings using this method may cause ION Setup to lose communications when the changes are sent to your meter. You must reconfigure ION Setup to match the new settings to re-establish communications with your meter.

1. Disconnect all serial devices presently connected to the Ethernet gateway's RS-485 port.
2. Configure the Ethernet gateway's serial port settings to match the meter's default serial communications settings:
 - Baud rate = 19200
 - Parity = Even

3. Connect the meter’s RS-485 port to the Ethernet gateway.
4. Connect the Ethernet gateway to the LAN.
5. Start ION Setup in Network mode.
6. Add an Ethernet gateway site and set its properties:
 - IP address = IP address of the Ethernet gateway
 - Port = 502 (for Modbus RTU)
7. Add a meter to the site and set its properties:
 - Type = PowerLogic PM5000 series Power Meter
 - Unit ID = 1
8. Use the **RS-485 Base Comm** setup screen to modify the meter’s serial communications settings.
9. Click **Send** to save your changes to the meter.

NOTE: If you set the protocol to ASCII 7, ASCII 8 or JBus, you cannot use ION Setup to reconnect to the meter – ION Setup does not communicate using these protocols.

Parameter	Values	Description
Protocol	Modbus RTU, JBus, ASCII 8, ASCII 7	Select the communications format used to transmit data. The protocol must be the same for all devices in a communications loop. NOTE: ION Setup does not support ASCII 8, ASCII 7 or JBus protocols.
Address	1 to 247	Set the address for this device. The address must be unique for each device in a communications loop. This value is used in both Modbus TCP/IP and serial communications.
Baud Rate	9600, 19200, 38400	Select the speed for data transmission. The baud rate must be the same for all devices in a communications loop.
Parity	Even, Odd, None	Select None if the parity bit is not used. The parity setting must be the same for all devices in a communications loop.

Post-requisite: Reconfigure ION Setup to match the changed settings in order to re-establish communications with your meter.

BACnet/IP

BACnet/IP protocol allows communication between the components of a building automation and control system (for example, HVAC, lighting control, security systems and related equipment).

The BACnet/IP protocol defines a number of services that are used to communicate between devices and the objects that are acted upon by those services.

Term	Definition
APDU	Application protocol data unit, that data portion of a BACnet message.
Confirmed message	A message for which the device expects an answer.
COV, COV increment	Change of value, sets the amount by which a value has to change in order for the meter to send a subscription notification.
Device	A BACnet device is a unit that is designed to understand and use BACnet protocol (for example, a BACnet-enabled meter or software program). It contains information about the device and device data in objects and object properties. Your meter is a BACnet device.

Term	Definition
Object	Represents the device and device data. Each object has a type (for example, analog input or binary input) and has a number of properties.
Present value	The current value of an object.
Property	The smallest piece of information in BACnet communications, it consists of a name, data type and value.
Service	Messages from one BACnet device to another.
Subscription	A relationship between a BACnet client and the meter, so that when the present value property of an object changes on the meter, a notification is sent to the client.
Subscription notification	The message the meter sends to indicate a COV event has occurred.
Unconfirmed message	A message for which the device does not expect an answer.
BACnet Broadcast Management Device (BBMD)	A BACnet/IP device (or software application) residing on a BACnet/IP subnet that forwards BACnet broadcast messages from devices on its subnet to peer BBMDs and registered foreign devices on other subnets.
Foreign device	A BACnet/IP device (or software application) that resides on a remote IP subnet and registers with a BBMD to facilitate the sending and receiving of broadcast messages to/from devices accessible by the BBMD.

Supported BACnet features

Your meter supports specific BACnet components and standard objects.

Go to www.schneider-electric.com and search for your meter model to access the PICS (Protocol Implementation Conformance Statement) for your meter.

Supported BACnet components

BACnet component	Description
Protocol version	1
Protocol revision	14
Standardized device profile (Annex L)	BACnet Application Specific Controller (B-ASC)
BACnet Interoperability Building Blocks (Annex K)	<ul style="list-style-type: none"> • DS-RP-B (Data Sharing - Read Property - B) • DS-RPM-B (Data Sharing - Read Property Multiple - B) • DS-WP-B (Data Sharing - Write Property - B) • DS-WPM-B (Data Sharing - Write Property Multiple - B) • DS-COV-B (Data Sharing - COV - B) • DM-DDB-B (Device Management - Dynamic Device Binding - B) • DM-DOB-B (Device Management - Dynamic Object Binding - B) • DM-DCC-B (Device Management - Device Communication Control - B)
BACnet/IP (Annex J)	BACnet communication internet protocol
Data link layer options	UDP
Character set ANSI	X3.4/UTF-8
Supported services	<ul style="list-style-type: none"> • subscribeCOV • readProperty • readPropertyMultiple • writeProperty • writePropertyMultiple • deviceCommunicationControl • who-HAS • who-Is • I-Am • I-Have • Confirmed COV notification

BACnet component	Description
	<ul style="list-style-type: none"> Unconfirmed COV notification
Segmentation	The meter does not support segmentation
Static device address binding	The meter does not support static device address binding
Networking options	The meter supports registration as a foreign device

Supported standard object types

NOTE: The BACnet protocol allows you to set the out-of-service property of an object to true and write a value to that property for testing purposes. In this case, your BACnet software displays the value you wrote to the object, not the actual value from the meter and the system it is monitoring. Make sure you set the out-of-service property of all objects to false before you put the meter into service.

Object type	Optional properties supported	Writeable properties supported	Conditional writeable properties supported
Device Object	<ul style="list-style-type: none"> Location Description Local_Time Local_Date Active_COV_Subscriptions Profile_Name 	<ul style="list-style-type: none"> Object_Name Object_Identifier Location Description APDU_Timeout Number_Of_APDU_Retries 	—
Analog Input Object	<ul style="list-style-type: none"> Description Reliability COV_Increment 	<ul style="list-style-type: none"> Out_Of_Service COV_Increment 	Present_Value
Binary Input Object	<ul style="list-style-type: none"> Description Reliability 	Out_Of_Service	Present_Value
Multi-state Input Object	<ul style="list-style-type: none"> Description Reliability State_Text 	Out_Of_Service	Present_Value

BACnet/IP communications implementation

Your meter's BACnet implementation includes specific behaviors and configuration.

Basic configuration for BACnet communications

Before communicating with the meter via BACnet protocol, make sure the basic BACnet settings are configured appropriately for your network. The Device ID must be unique in your BACnet IP network.

Change of Value (COV) subscriptions

The meter supports up to 20 COV subscriptions. You can add COV subscriptions to Analog Input, Binary Input and Multi-state Input objects using your BACnet-compatible software.

Configuring BACnet/IP settings using the display

Use the meter's display to configure BACnet/IP settings if required.

1. Navigate to **Maint > Setup**.
2. Enter the setup password then press **OK**.
3. Navigate to **Comm > BACnet**.

4. Move the cursor to point to the parameter you want to modify, then press **Edit**.
5. Modify the parameter as required, then press **OK**.
6. Move the cursor to point to the next parameter you want to modify, press **Edit**, make your changes, then press **OK**.
7. Press the up arrow to exit.

Basic BACnet/IP settings available using the display

Parameter	Values	Description
Status	Enabled, Disabled	Enable or disable BACnet/IP communications with the meter
Device ID	0 – 4194302	Enter the ID of the meter on your BACnet network. The ID must be unique on the network.
UDP Port	1024 – 65535	Enter the port the meter uses for BACnet/IP communications. The default is the standard BACnet/IP port (47808).

Foreign device settings available using the display

Parameter	Values	Description
BBMD Status	Enabled, Disabled	Enable or disabled registration of the meter as a foreign device.
BBMD IP	Contact your local network administrator for parameter values.	Enter the IP address of the BACnet/IP Broadcast Management Device (BBMD), if you use a BBMD on your network.
BBMD Port	1024 – 65535	Enter the port number that is used for communications with the BBMD. The default is the standard BACnet/IP port (47808)
BBMD TTL (sec)	0 – 65535	The length of time (in seconds) the BBMD keeps an entry for this device in its foreign device table.

Configuring BACnet/IP settings using the webpages

Use the meter’s webpages to configure BACnet/IP settings if required.

1. Log in to the meter webpages using Product Master or Web Master credentials.
2. Click **Settings > BACnet/IP Settings**.
3. Configure the settings as required for your BACnet network.

4. Click **Save changes**.**Basic BACnet/IP settings available using the webpages**

Parameter	Values	Description
Enable BACnet/IP	Yes, No	Enable or disable BACnet/IP communications with the meter
Device ID	0 – 4194302	Enter the ID of the meter on your BACnet network. The ID must be unique on the network.
BACnet Port	1024 – 65535	Enter the port the meter uses for BACnet/IP communications. The default is the standard BACnet/IP port (47808).

Foreign device settings available using the webpages

Parameter	Values	Description
BBMD Status	Enabled, Disabled	Enable or disabled registration of the meter as a foreign device.
BBMD IP Address	Contact your local network administrator for parameter values.	Enter the IP address of the BACnet/IP Broadcast Management Device (BBMD), if you use a BBMD on your network.
BBMD Port	1024 – 65535	Enter the port number that is used for communications with the BBMD. The default is the standard BACnet/IP port (47808).
Time To Live	0 – 65535	The length of time (in seconds) the BBMD keeps an entry for this device in its foreign device table.

BACnet objects**Device object**

Your meter has a Device object which describes the meter to the BACnet network.

The following table outlines the properties of the Device object, whether a property is read-only or read-write, and if the value of the property is stored in the meter's nonvolatile onboard memory.

Device object property	R/W	Stored	Possible values	Description
Object_Identifier	R/W	Y	See description	The unique device ID number for the meter, in the format of <device, #>. The meter ships from the factory with a device ID equal to the last 6 digits of the serial number.
Object_Name	R/W	Y	See description	A configurable name for the meter. The meter ships from the factory with a name of <model name> <serial number> (for example, PM5560_0000000000).
Object_Type	R	—	Device	The object type for the meter.
System_Status	R	—	Operational	This value of this property is always Operational.
Vendor_Name	R	—	Schneider Electric	Meter manufacturer
Vendor_Identifier	R	—	10	The BACnet vendor identifier for Schneider Electric.
Model_Name	R	—	varies	Device model (for example, PM5560) and serial number in the format <model name> <serial number> (for example, PM5560_0000000000).
Firmware_Revision	R	—	varies	BACnet firmware version, stored in an x.x.x format (for example, 1.9.0).
Application_Software_Version	R	—	varies	Meter firmware version, stored in an x.x.x format (for example, 1.0.305).

Device object property	R/W	Stored	Possible values	Description
Description	R/W	Y	configurable	Optional description of the meter, limited to 64 characters.
Location	R/W	Y	configurable	Optional description of the meter's location, limited to 64 characters.
Protocol_Version	R	—	varies	BACnet protocol version (for example, version 1)
Protocol_Revision	R	—	varies	BACnet protocol revision (for example, revision 14)
Protocol_Services_Supported	R	—	0000 0100 0000 1011 1100 1000 0000 0000 0110 0000 0	The BACnet services supported by the meter: subscribeCOV, readProperty, readPropertyMultiple, writeProperty, writePropertyMultiple, deviceCommunicationControl, ReinitializeDevice, who-HAS, who-Is
Protocol_Object_Types_Supported	R	—	1001 0000 1000 0100 0000 0000 0000 0000 0000 0000 0000 0000 0000 000	The BACnet object types supported by the meter: analog input, binary input, multi-state input, device.
Object_list	R	—	See description	List of objects in the meter.
Max_APDU_Length_Accepted	R	—	1476	The maximum packet size (or application protocol data unit) that the meter can accept, in bytes.
Segmentation_Supported	R	—	0x03	The meter does not support segmentation.
Local_Date	R	—	varies	Current date on the meter NOTE: Use the display, the webpages or ION Setup to set the meter's date.
Local_Time	R	—	varies	Current time on the meter NOTE: Use the display, the webpages or ION Setup to set the meter's time. You can also set up SNTP time synchronization using the webpages.
APDU_Timeout	R/W	Y	1000 – 30000	The amount of time (in milliseconds) before the meter tries to resend a confirmed message that has not been answered.
Number_Of_APDU_Retries	R/W	Y	1 – 10	The number of times the meter tries to resend an unanswered confirmed request.
Device_Address_Binding	R	—	—	Device address binding table is always blank because the meter does not initiate the who-Is service.
Database_Revision	R	Y	varies	A number that increments when the object database on the meter changes (for example, when an object is created or deleted or the ID of an object changes).
Active_COV_Subscriptions	R	—	varies	List of COV subscriptions currently active on the meter.
Profile_Name	R	—	varies	Device identifier that records the meter manufacturer, the meter family and the specific meter model (for example, 10-PM5000-PM5560).

Analog Input objects

Your meter has a number of Analog Input objects that provide meter values and information on meter settings.

The following tables list the Analog Input objects along with the units and default COV value for each object (if applicable).

Real-time measurements

Object ID	Object name	Units	Default COV	Description
3000	Current - Ph A	A	50	Current phase A
3002	Current - Ph B	A	50	Current phase B
3004	Current - Ph C	A	50	Current phase C
3006	Current - Neutral	A	50	Neutral current
3008	Current - Ground	A	50	Ground current
3010	Current - Avg	A	50	Current average
3012	Current Unb - Ph A	%	20	Current unbalance phase A
3014	Current Unb - Ph B	%	20	Current unbalance phase B
3016	Current Unb - Ph C	%	20	Current unbalance phase C
3018	Current Unb - Worst	%	20	Current unbalance worst
3020	Voltage - A-B	V	10	Voltage A-B
3022	Voltage - B-C	V	10	Voltage B-C
3024	Voltage - C-A	V	10	Voltage C-A
3026	Voltage - Avg L-L	V	10	Voltage L-L Avg
3028	Voltage - A-N	V	10	Voltage A-N
3030	Voltage - B-N	V	10	Voltage B-N
3032	Voltage - C-N	V	10	Voltage C-N
3036	Voltage - Avg L-N	V	10	Voltage L-N Avg
3038	Voltage Unb - A-B	%	20	Voltage unbalance A-B
3040	Voltage Unb - B-C	%	20	Voltage unbalance B-C
3042	Voltage Unb - C-A	%	20	Voltage unbalance C-A
3044	Voltage Unb - Worst L-L	%	20	Voltage unbalance L-L worst
3046	Voltage Unb - A-N	%	20	Voltage unbalance A-N
3048	Voltage Unb - B-N	%	20	Voltage unbalance B-N
3050	Voltage Unb - C-N	%	20	Voltage unbalance C-N
3052	Voltage Unb - Worst L-N	%	20	Voltage unbalance L-N worst
3110	Frequency	Hz	10	Frequency

Power and power factor

Object ID	Object name	Units	Default COV	Description
3054	Active Power - Ph A	kW	10	Active power phase A
3056	Active Power - Ph B	kW	10	Active power phase B
3058	Active Power - Ph C	kW	10	Active power phase C
3060	Active Power - Total	kW	10	Active power total
3062	Reactive Power - Ph A	kVAR	10	Reactive power phase A
3064	Reactive Power - Ph B	kVAR	10	Reactive power phase B
3066	Reactive Power - Ph C	kVAR	10	Reactive power phase C
3068	Reactive Power - Total	kVAR	10	Reactive power total

Object ID	Object name	Units	Default COV	Description
3070	Apparent Power - Ph A	kVA	10	Apparent power phase A
3072	Apparent Power - Ph B	kVA	10	Apparent power phase B
3074	Apparent Power - Ph C	kVA	10	Apparent power phase C
3076	Apparent Power - Total	kVA	10	Apparent power total
3078	Power Factor - Ph A	—	0.2	Power factor phase A
3080	Power Factor - Ph B	—	0.2	Power factor phase B
3082	Power Factor - Ph C	—	0.2	Power factor phase C
3084	Power Factor - Total	—	0.2	Power Factor Total

Energy and energy by tariff measurements

Object ID	Object name	Units	Default COV	Description
2700	Active Energy Delvd	kWh	100	Active energy delivered
2702	Active Energy Rcvd	kWh	100	Active energy received
2704	Active Energy Delvd + Rcvd	kWh	100	Active energy delivered + received
2706	Active Energy Delvd - Rcvd	kWh	100	Active energy delivered – received
2708	Reactive Energy Delvd	kVARh	100	Reactive energy delivered
2710	Reactive Energy Rcvd	kVARh	100	Reactive energy received
2712	Reactive Energy Delvd + Rcvd	kVARh	100	Reactive energy delivered + received
2714	Reactive Energy Delvd - Rcvd	kVARh	100	Reactive energy delivered – received
2716	Apparent Energy Delvd	kVAh	100	Apparent energy delivered
2718	Apparent Energy Rcvd	kVAh	100	Apparent energy received
2720	Apparent Energy Delvd + Rcvd	kVAh	100	Apparent energy delivered + received
2722	Apparent Energy Delvd - Rcvd	kVAh	100	Apparent energy delivered – received
4191	Applicable Tariff Energy Rate	—	1	Denotes the active tariff. 0 = Multi Tariff feature is disabled 1 = tariff 1 active 2 = tariff 2 active 3 = tariff 3 active 4 = tariff 4 active 5 = tariff 5 active 6 = tariff 6 active 7 = tariff 7 active 8 = tariff 8 active
4800	Active Energy Delvd (Tariff 1)	kWh	100	Tariff 1 active energy import
4802	Active Energy Delvd (Tariff 2)	kWh	100	Tariff 2 active energy import
4804	Active Energy Delvd (Tariff 3)	kWh	100	Tariff 3 active energy import
4806	Active Energy Delvd (Tariff 4)	kWh	100	Tariff 4 active energy import

Object ID	Object name	Units	Default COV	Description
4808	Active Energy Delvd (Tariff 5)	kWh	100	Tariff 5 active energy import
4810	Active Energy Delvd (Tariff 6)	kWh	100	Tariff 6 active energy import
4812	Active Energy Delvd (Tariff 7)	kWh	100	Tariff 7 active energy import
4814	Active Energy Delvd (Tariff 8)	kWh	100	Tariff 8 active energy import

Power demand

Object ID	Object name	Units	Default COV	Description
3764	Dmd - Active Power Last	kW	10	Demand - Active power last
3766	Dmd - Active Power Present	kW	10	Demand - Active power present
3768	Dmd - Active Power Pred	kW	10	Demand - Active power predicted
3770	Dmd - Active Power Peak	kW	10	Demand - Active power peak
3780	Dmd - Reactive Power Last	KVAR	10	Demand - Reactive power last
3782	Dmd - Reactive Power Present	KVAR	10	Demand - Reactive power present
3784	Dmd - Reactive Power Pred	KVAR	10	Demand - Reactive power predicted
3786	Dmd - Reactive Power Peak	KVAR	10	Demand - Reactive power peak
3796	Dmd - Apparent Power Last	kVA	10	Demand - Apparent power last
3798	Dmd - Apparent Power Present	kVA	10	Demand - Apparent power present
3800	Dmd - Apparent Power Pred	kVA	10	Demand - Apparent power predicted
3802	Dmd - Apparent Power Peak	kVA	10	Demand - Apparent power peak
3972	Dmd - Active Power Ph A Last	kW	10	Demand - Active power phase A last
3974	Dmd - Active Power Ph A Present	kW	10	Demand - Active power phase A present
3976	Dmd - Active Power Ph A Pred	kW	10	Demand - Active power phase A predicted
3978	Dmd - Active Power Ph A Peak	kW	10	Demand - Active power phase A peak
3988	Dmd - Reactive Power Ph A Last	KVAR	10	Demand - Reactive power phase A last
3990	Dmd - Reactive Power Ph A Present	KVAR	10	Demand - Reactive power phase A present
3992	Dmd - Reactive Power Ph A Pred	KVAR	10	Demand - Reactive power phase A predicted
3994	Dmd - Reactive Power Ph A Peak	KVAR	10	Demand - Reactive power phase A peak
4004	Dmd - Apparent Power Ph A Last	kVA	10	Demand - Apparent power phase A last

Object ID	Object name	Units	Default COV	Description
4006	Dmd - Apparent Power Ph A Present	kVA	10	Demand - Apparent power phase A present
4008	Dmd - Apparent Power Ph A Pred	kVA	10	Demand - Apparent power phase A predicted
4010	Dmd - Apparent Power Ph A Peak	kVA	10	Demand - Apparent power phase A peak
4020	Dmd - Active Power Ph B Last	kW	10	Demand - Active power phase B last
4022	Dmd - Active Power Ph B Present	kW	10	Demand - Active power phase B present
4024	Dmd - Active Power Ph B Pred	kW	10	Demand - Active power phase B predicted
4026	Dmd - Active Power Ph B Peak	kW	10	Demand - Active power phase B peak
4036	Dmd - Reactive Power Ph B Last	kVAR	10	Demand - Reactive power phase B last
4038	Dmd - Reactive Power Ph B Present	kVAR	10	Demand - Reactive power phase B present
4040	Dmd - Reactive Power Ph B Pred	kVAR	10	Demand - Reactive power phase B predicted
4042	Dmd - Reactive Power Ph B Peak	kVAR	10	Demand - Reactive power phase B peak
4052	Dmd - Apparent Power Ph B Last	kVA	10	Demand - Apparent power phase B last
4054	Dmd - Apparent Power Ph B	kVA	10	Demand - Apparent power phase B present
4056	Dmd - Apparent Power Ph B Pred	kVA	10	Demand - Apparent power phase B predicted
4058	Dmd - Apparent Power Ph B Peak	kVA	10	Demand - Apparent power phase B peak
4068	Dmd - Active Power Ph C Last	kW	10	Demand - Active power phase C last
4070	Dmd - Active Power Ph C Present	kW	10	Demand - Active power phase C present
4072	Dmd - Active Power Ph C Pred	kW	10	Demand - Active power phase C predicted
4074	Dmd - Active Power Ph C Peak	kW	10	Demand - Active power phase C peak
4084	Dmd - Reactive Power Ph C Last	kVAR	10	Demand - Reactive power phase C last
4086	Dmd - Reactive Power Ph C Present	kVAR	10	Demand - Reactive power phase C present
4088	Dmd - Reactive Power Ph C Pred	kVAR	10	Demand - Reactive power phase C predicted
4090	Dmd - Reactive Power Ph C Peak	kVAR	10	Demand - Reactive power phase C peak
4100	Dmd - Apparent Power Ph C Last	kVA	10	Demand - Apparent power phase C last
4102	Dmd - Apparent Power Ph C Present	kVA	10	Demand - Apparent power phase C present
4104	Dmd - Apparent Power Ph C Pred	kVA	10	Demand - Apparent power phase C predicted
4106	Dmd - Apparent Power Ph C Peak	kVA	10	Demand - Apparent power phase C peak

Current demand

Object ID	Object name	Units	Default COV	Description
3812	Dmd - Active Current Ph A Last	A	10	Demand - Active current phase A last
3814	Dmd - Current Ph A Present	A	10	Demand - Current phase A present
3816	Dmd - Active Current Ph A Pred	A	10	Demand - Active current phase A predicted
3818	Dmd - Active Current Ph A Peak	A	10	Demand - Active current phase A peak
3828	Dmd - Active Current Ph B Last	A	10	Demand - Active current phase B last
3830	Dmd - Current Ph B Present	A	10	Demand - Current phase B present
3832	Dmd - Active Current Ph B Pred	A	10	Demand - Active current phase B predicted
3834	Dmd - Active Current Ph B Peak	A	10	Demand - Active current phase B peak
3844	Dmd - Active Current Ph C Last	A	10	Demand - Active current phase C last
3846	Dmd - Current Ph C Present	A	10	Demand - Current phase C present
3848	Dmd - Active Current Ph C Pred	A	10	Demand - Active current phase C predicted
3850	Dmd - Active Current Ph C Peak	A	10	Demand - Active current phase C peak
3860	Dmd - Current Neutral Last	A	10	Demand - Current neutral last
3862	Dmd - Current Neutral Present	A	10	Demand - Current neutral present
3864	Dmd - Current Neutral Pred	A	10	Demand - Current neutral predicted
3866	Dmd - Current Neutral Peak	A	10	Demand - Current neutral peak
3876	Dmd - Average Current Last	A	10	Demand - Average current last
3878	Dmd - Avg Current Present	A	10	Demand - Average current present
3880	Dmd - Average Current Pred	A	10	Demand - Average current predicted
3882	Dmd - Average Current Peak	A	10	Demand - Average current peak

Power quality

Object ID	Object name	Units	Default COV	Description
21300	THD Current - Ph A	%	20	THD Current A
21302	THD Current - Ph B	%	20	THD Current B
21304	THD Current - Ph C	%	20	THD Current C
21306	THD Current - Ph N	%	20	THD Current N
21308	THD Current - Ph G	%	20	THD Current G
21310	thd Current - Ph A	%	20	thd Current A
21312	thd Current - Ph B	%	20	thd Current B
21314	thd Current - Ph C	%	20	thd Current C

Object ID	Object name	Units	Default COV	Description
21316	thd Current - Ph N	%	20	thd Current N
21318	thd Current - Ph G	%	20	thd Current G
21320	Total Dmd Distortion	%	20	Total Demand Distortion
21322	THD Voltage - A-B	%	20	THD Voltage A-B
21324	THD Voltage - B-C	%	20	THD Voltage B-C
21326	THD Voltage - C-A	%	20	THD Voltage C-A
21328	THD Voltage - Avg L-L	%	20	THD Voltage L-L
21330	THD Voltage - A-N	%	20	THD Voltage A-N
21332	THD Voltage - B-N	%	20	THD Voltage B-N
21334	THD Voltage - C-N	%	20	THD Voltage C-N
21338	THD Voltage - Avg L-N	%	20	THD Voltage L-N
21340	thd Voltage - A-B	%	20	thd Voltage A-B
21342	thd Voltage - B-C	%	20	thd Voltage B-C
21344	thd Voltage - C-A	%	20	thd Voltage C-A
21346	thd Voltage - Avg L-L	%	20	thd Voltage L-L
21348	thd Voltage - A-N	%	20	thd Voltage A-N
21350	thd Voltage - B-N	%	20	thd Voltage B-N
21352	thd Voltage - C-N	%	20	thd Voltage C-N
21356	thd Voltage - Avg L-N	%	20	thd Voltage L-N

Meter information

The following table lists Analog Input objects that provide information about the meter and its configuration.

NOTE: You can access the meter’s configuration information over BACnet communications. However, you must use the display, meter webpages or ION Setup to configure the meter’s settings.

Object ID	Object name	Units	Default COV	Description
2000	Time since last meter power up	Seconds	604800	Time since the meter was last powered up
2004	Meter operation timer	Seconds	604800	Total meter operation time
2014	Number of phases	—	1	Number of phases 1, 3
2015	Number of wires	—	1	Number of wires 2, 3, 4
2017	Nominal frequency	Hz	1	Nominal frequency 50, 60
2025	Number of VTs	—	1	Number of VTs 0, 2, 3
2026	VT primary	V	1	VT Primary
2028	VT secondary	V	1	VT Secondary
2029	Number of CTs	—	1	Number of CTs 1, 2, 3, 4
2030	CT primary	A	1	CT Primary
2031	CT secondary	A	1	CT Secondary

Binary Input objects

Your meter has a number of Binary Input objects that provide the status information from the meter's I/O.

The following table lists the Binary Input (BI) objects available on the meter.

Object ID	Object name	Description
38416 – 38419	Digital Input 1, Digital Input 2, Digital Input 3, Digital Input 4	Status of digital inputs 1 to 4: 0 = on 1 = off NOTE: This information only applies if the digital input is configured as a status input.
38448, 38449	Digital Output 1, Digital Output 2	Status of digital outputs 1 and 2: 0 = on 1 = off

Multi-state Input objects

Your meter has a number of Multi-state Input objects that provide information about the meter's I/O and power system settings.

Meter configuration multi-state input objects

Object ID	Object name	Object name / description
2016	Power System Type	Power system configuration: 0 = 1PH2W L-N 1 = 1PH2W L-L 2 = 1PH3W L-L with N 3 = 3PH3W ungrounded delta 4 = 3PH3W corner grounded delta 5 = 3PH3W ungrounded wye 6 = 3PH3W grounded wye 7 = 3PH3W resistance grounded wye 8 = 3PH4W center-tapped open delta 9 = 3PH4W center-tapped delta 10 = 3PH4W ungrounded wye 11 = 3PH4W grounded wye 12 = 3PH4W resistance grounded wye
2036	VT Connection Type	VT connection type: 0 = Direct connect 1 = Delta (2 VT) 2 = Wye (3 VT) 3 = L-N (1 VT) 4 = L-L (1 VT) 5 = L-L with N (2 VT)
3701	Demand Method - Power	Power demand method: 0 = Thermal demand 1 = Timed interval sliding block 2 = Timed interval block 3 = Timed interval rolling block 4 = Input synchronized block 5 = Input synchronized rolling block 6 = Command synchronized block 7 = Command synchronized rolling block 8 = Clock synchronized block 9 = Clock synchronized rolling block

Object ID	Object name	Object name / description
3711	Demand Method - Current	Current demand method: 0 = Thermal demand 1 = Timed interval sliding block 2 = Timed interval block 3 = Timed interval rolling block 4 = Input synchronized block 5 = Input synchronized rolling block 6 = Command synchronized block 7 = Command synchronized rolling block 8 = Clock synchronized block 9 = Clock synchronized rolling block
3721	Demand Method - Input Metering	Input metering demand method: 0 = Thermal demand 1 = Timed interval sliding block 2 = Timed interval block 3 = Timed interval rolling block 4 = Input synchronized block 5 = Input synchronized rolling block 6 = Command synchronized block 7 = Command synchronized rolling block 8 = Clock synchronized block 9 = Clock synchronized rolling block

I/O multi-state input objects

The following table lists the Multi-state Input objects that provide information about meter’s I/O configuration.

Object ID	Object name	Description
7274, 7298, 7322, 7346	Digital Input 1 Mode, Digital Input 2 Mode, Digital Input 3 Mode, Digital Input 4 Mode	Digital Input 1 to 4 control mode 0 = Normal (Alarm) 1 = Demand Interval Sync Pulse 2 = Multi-tariff Control 3 = Input Metering
9673, 9681	Digital Output Mode 1, Digital Output Mode 2	Digital output 1 and 2 control mode 0 = External 1 = Demand Sync 2 = Alarm 3 = Energy

Modbus Ethernet gateway

The meter’s Ethernet gateway feature extends the meter’s functionality by allowing Ethernet access to serial devices connected to the meter’s RS-485 serial communications port.

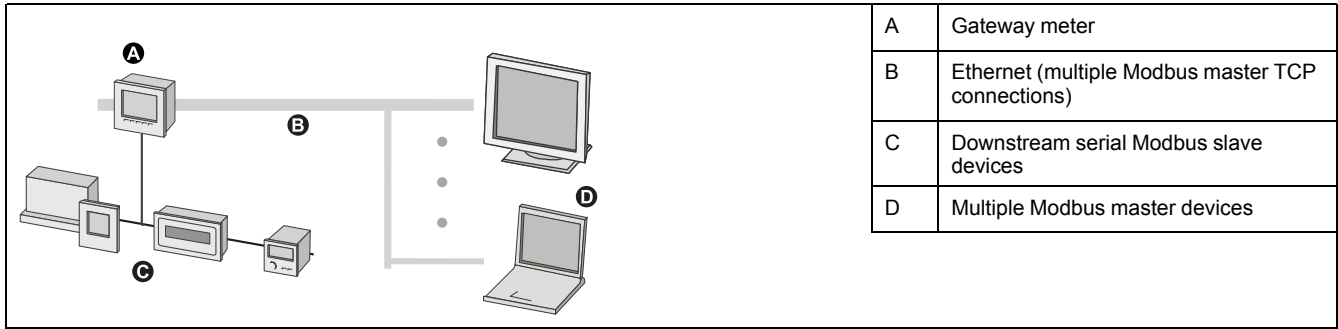

A Modbus master device (such as an energy management system) can communicate through the gateway meter to a serial network of devices connected to the gateway meter’s serial port(s). The meter receives Modbus TCP/IP data on TCP port 502, translates it to Modbus RTU then forwards it to the addressed slave device.

This functionality allows the use of monitoring software to access information from slave devices for data collection, trending, alarm/event management, analysis, and other functions.

Ethernet gateway implementation

There is specific implementation information to consider when using your meter as an Ethernet gateway.

Firmware support

The Ethernet gateway functionality is available on firmware version 2.0.1 or later.

Addressing

You can use slave address 255 or the Unit ID configured in the gateway meter’s serial settings to send a request to the gateway-enabled meter itself. Messages addressed with other unit IDs are forwarded by the gateway meter to the RS-485 slave devices

Broadcast messages

The gateway meter always processes broadcast messages (in other words, messages sent to Unit ID 0). You can configure whether or not broadcast messages are forwarded to the slave devices.

Modbus master TCP/IP connections

The maximum number of Modbus master TCP connections allowed for the Ethernet gateway is configurable. It is the same as the maximum number of total Modbus TCP/IP connections that are configured on the gateway-enabled meter.

Related Topics

- Setting up serial communications using the display

Ethernet gateway configuration

Configuring the meter as an Ethernet gateway using the webpages

The meter can function as an Ethernet gateway, allowing Ethernet access to serial devices connected to the meter’s RS-485 serial communications port.

You must install the serial Modbus slave devices, configure them and connect them to your Ethernet-connected Modbus gateway meter. Ensure that each serial device is configured to communicate over Modbus with the same baud rate and parity as the gateway device, and that each device, including the gateway, has a unique unit ID.

The only configuration required for the meter to function as a gateway is to set the serial port's mode. You can configure other settings, depending on your requirements and network.

NOTE: The protocol of the serial port must be set to Modbus RTU or Jbus for the meter to function as a gateway.

1. Log in to the meter webpages using Product Master or Web Master credentials.
2. Navigate to **Settings > Serial Settings**.
3. Set **Mode** set to Gateway to enable the gateway feature or to Slave to disable it.
4. Set **Modbus Broadcast** to Enabled if you want broadcast messages to be forwarded to the connected slave devices.
5. Configure the other advanced parameters are required by your system.
6. Navigate to **Settings > Advanced Ethernet Settings** and change the **Modbus TCP/IP Server Connections** to adjust the maximum number of Modbus TCP connections allowed.

Modbus Ethernet gateway settings available using the webpages

Parameter	Value	Description
Response Timeout	0.1, 0.2, 0.3, 0.4, 0.5, 1, 2, 3, 4, 5, 6, 7, 8, 9, 10	Set the time the gateway meter waits for an answer from a downstream serial device before generating an exception response.
Delay Between Frames	0, 10, 20, 30, 40, 50, 60, 70, 80, 90, 100	The minimum time in milliseconds between the end of a received response and the beginning of a new request. Set this parameter to help improve communications between the gateway and downstream slave devices with slower response times.
Silent Interval Extension	0 – 15	Set this parameter to extend the silent interval (used to mark the end of a Modbus packet) beyond the default 3.5 characters defined in the Modbus standard. After the defined character time elapses without a new character, the gateway meter treats the next character as the start of a new message.

NOTE: These are advanced settings that you can adjust if you have communications errors when communicating through the gateway to the downstream serial devices. They only apply if the meter is functioning as a gateway, and you should only change these settings if you have an advanced knowledge of Modbus communications and your communications network.

Configuring the meter as an Ethernet gateway using ION Setup

The meter can function as an Ethernet gateway, allowing Ethernet access to serial devices connected to the meter's RS-485 serial communications port.

You must install the serial Modbus slave devices, configure them and connect them to your Ethernet-connected Modbus gateway meter. Ensure that each serial device is configured to communicate over Modbus with the same baud rate and parity as the gateway device, and that each device, including the gateway, has a unique unit ID.

The only configuration required for the meter to function as a gateway is to set the serial port's mode. You can configure other settings, depending on your requirements and network.

NOTE: The protocol of the serial port must be set to Modbus RTU or Jbus for the meter to function as a gateway.

1. Start ION Setup and connect to your meter.
2. Open the **Advanced Serial Settings** screen in the **RS-485 Comm Setup** folder.
3. Set **Mode** to Master Mode to enable the gateway feature or to Slave Mode to disable it.
4. Set **Modbus Broadcast** to Enabled if you want broadcast messages to be forwarded to the connected slave devices.
5. Configure the other advanced parameters are required by your system.
6. Click **Send** to save your changes to the meter.
7. Use the meter webpages if you want to adjust the maximum number of Modbus TCP connections allowed.

Modbus Ethernet gateway settings available using ION Setup

Parameter	Value	Description
Response Timeout	0.1, 0.2, 0.3, 0.4, 0.5, 1, 2, 3, 4, 5, 6, 7, 8, 9, 10	Set the time the gateway meter waits for an answer from a downstream serial device before generating an exception response.
Delay Between Frames	0, 10, 20, 30, 40, 50, 60, 70, 80, 90, 100	The minimum time in milliseconds between the end of a received response and the beginning of a new request. Set this parameter to help improve communications between the gateway and downstream slave devices with slower response times.
Silent Interval Extension	0 – 15	Set this parameter to extend the silent interval (used to mark the end of a Modbus packet) beyond the default 3.5 characters defined in the Modbus standard. After the defined character time elapses without a new character, the gateway meter treats the next character as the start of a new message.

NOTE: These are advanced settings that you can adjust if you have communications errors when communicating through the gateway to the downstream serial devices. They only apply if the meter is functioning as a gateway, and you should only change these settings if you have an advanced knowledge of Modbus communications and your communications network.

Modbus TCP/IP filtering

The Modbus TCP/IP filtering feature lets you specify the access rights to the meter, using Modbus communications, for specified IP addresses plus the access rights for anonymous IP addresses.

This feature determines the access to the meter and any downstream serial devices if the meter is functioning as a Modbus gateway.

Modbus TCP/IP filtering implementation

You can specify the Modbus access rights for up to 10 unique IP addresses and for anonymous IP addresses.

By default, Modbus TCP/IP filtering is disabled and all IP addresses have full access to the meter and any downstream serial devices.

Access levels

You can set the level of access for each configured IP address, as well as for anonymous IP addresses.

Access level	Description
Read-only	This settings allows only the following function codes to be sent to the meter and any downstream serial devices from the specified IP address: 01 (0x01), 02 (0x02), 03 (0x03), 04 (0x04), 07 (0x07), 08 (0x08), 11 (0x0B), 12 (0x0C), 17 (0x11), 20 (0x14), 24 (0x18), 43 (0x2B) and 100 (0x64)
Full	This setting allows any Modbus function code to be sent to the meter and any downstream serial devices from the specified IP address.
None	This setting denies access to anonymous IP addresses.

Configuring Modbus TCP/IP filtering

You can configure access rights for any valid IP address, plus any anonymous IP addresses.

1. Log in to the meter webpages using Product Master or Web Master credentials.
2. Navigate to **Settings > Modbus TCP/IP filtering**.
3. Click **Yes** to enable Modbus TCP/IP filtering.

The IP address fields become editable, except for the anonymous IP address field, which is indicated by asterisks (**.*.*.*.*).

4. Set the access for anonymous IP addresses.

NOTE: If Modbus TCP/ IP filtering is enabled, anonymous IP addresses can only have read-only or no access; they cannot have full access.

5. Enter the other IP addresses that you want to be able to access the meter and any downstream serial devices.
6. Set the access level for each specified IP address.

NOTE: If duplicate IP addresses are entered, the second listing and its access level are discarded when you save the changes.

Simple Network Management Protocol (SNMP)

Your meter supports SNMP once you have enabled SNMP on your meter. You need to upload the meter’s MIB file (available from www.schneider-electric.com) into the NMS managing your meter.

Simple Network Management Protocol (SNMP) is part of the Transmission Control Protocol/Internet Protocol (TCP/IP) protocol suite. SNMP is an application layer protocol that enables the exchange of network management information between devices, allowing you to manage network performance and to identify and solve problems on networks with devices of various types.

SNMP configuration assumes that you have an advanced understanding of SNMP and the communications network and power system that your meter is connected to.

Key terms

Term	Definition
Agent	Software resident on the managed device which interfaces between the device and the NMS.
Managed device	Your meter in the SNMP network.
Community name/string	A text string that helps authenticate requests between the managed device and the NMS.

Term	Definition
Managed object	Any parameter referenced in the MIB file.
MIB	A management information base which organizes the OIDs in a hierarchical tree.
NMS	A network management station, manager or client that executes applications to monitor and control devices. An NMS must have the standard and custom MIB files and SNMP manager software.
OID	An object identifier that uniquely identifies and labels a managed object in the MIB.
Trap receiver	An NMS that is configured to receive traps and whose IP address is an SNMP trap destination.

The meter in an SNMP system

Your meter is a managed device with an SNMP agent in an SNMP network.

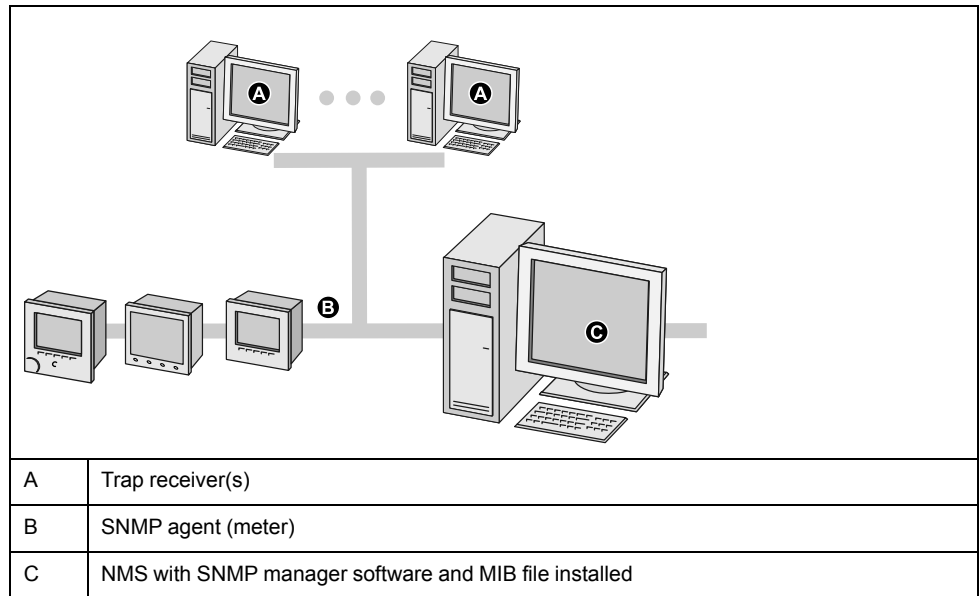

NOTE: The NMS computer can also function as a trap receiver.

SNMP implementation

Your meter supports SNMP after you upload the meter’s MIB file into the NMS managing your meter.

By default, SNMP communication is enabled and SNMP trapping is disabled. Use the meter’s webpages to enable / disable SNMP and configure SNMP parameters.

Supported requests

Your meter supports get and get-next requests (read-only).

MIB file

The MIB file is a human-readable text file. Besides being required by your NMS, you can use it to determine the objects the meter supports and their object IDs.

SNMP requires that you load your meter’s MIB file (available for download from www.schneider-electric.com) into the NMS. The MIB filename is SchneiderPM556x_Vyy_zz.MIB, where yy is the major revision and zz is the minor revision.

Your meter is compliant with MIB-II as defined by the standard MIB file RFC 1213. You must install RFC 1213, which is required to read basic network information for

the meter (for example, TCP/IP traffic or number of packets received), if it is not included with your SNMP manager software.

Community names

A community name is a text string which acts to help authenticate requests from the NMS to your meter. There are two configurable community names on your meter:

- Read Only Community: this community name's initial factory-set value is public.
- Read Write Community: this community name's initial factory-set value is private.

If your meter receives an incorrect community string, it generates an AuthenticationFailure trap.

System variables

A system variable is a text string which can be configured to provide information about your meter. There are three system variables on your meter:

- System contact: the name of the SNMP system administrator.
- System name: a descriptive name for your meter or the system where it is installed.
- System location: a description of your meter's location.

SNMP ports

The meter is configured to use standard SNMP ports to receive requests.

Port	Description
161	Receives requests When the SNMP agent (the meter) receives a request on port 161, a response is sent to the source port on the NMS.
162	Receives notifications (traps)

The meter sends notifications from any available port.

SNMP trapping

SNMP trapping allows your meter's agent to notify the NMS of events with an unsolicited SNMP message (a "trap" of the meter's alarm event).

SNMP trapping is only supported on SNMP v2.

Supported generic traps

SNMP generic traps supported by your meter are:

- coldStart: the meter (SNMP agent) is starting, and its configuration may have been altered.
- warmStart: the meter (SNMP agent) is starting, and its configuration has not been altered.
- linkDown: there is a failure in the communications link between the meter (SNMP agent) and the NMS.
- linkUp: the SNMP agent is enabled and the communications link is established.
- authenticationFailure: the meter (SNMP agent) has received an incorrect community value.

Supported enterprise-specific traps

Your meter sends SNMP traps to the NMS for all high, medium and low priority alarms configured on the meter. The trap includes information about the alarm, such as the alarm label or description, timestamp, state, priority, value of the parameter when the alarm occurred, and the alarm type.

Trap IP addresses

You can enter up to two IPv4 IP addresses for SNMP trap notification.

Configuring SNMP using the webpages

You can configure your meter's SNMP settings using the webpages.

1. Log in to the meter webpages using Product Master or Web Master credentials.
2. Click **Settings > SNMP Settings**.
3. Modify the settings as required.

SNMP parameters available using the webpages

Parameter	Values	Description
Enable SNMP	Yes / No	Enables or disables SNMP on your meter
System Contact	—	Enter the name of your SNMP administrator
System Name	—	Enter a descriptive name for your meter
System Location	—	Enter your meter's location
Read-only Community Name / Read-write Community Name	—	Enter the community name used for SNMP requests
Enable SNMP Traps	Yes / No	Enables SNMP trapping on your meter
Trap Receiver 1 IP Address / Trap Receiver 2 IP Address	—	Enter up to 2 trap receiver IP addresses where trap messages are sent

FTP

Your meter has an internal FTP server that you can use to load files, such as custom webpages, and upgrade your meter and meter accessories.

File transfer protocol (FTP) is a standard, client-server network protocol used to transfer files over TCP (Ethernet) networks.

Related Topics

- [Upgrading your meter](#)

FTP file structure

Your meter's FTP server contains an fw and a www folder.

- fw: this folder is where you can load firmware update files for your meter and the meter's Ethernet card.
- www: this folder is where the meter's default webpages are stored. You can also load updated default webpages or add custom webpages by copying them into the folder.

FTP file permissions

You must use a user account assigned to the Product Master group in order to access the meter's FTP server.

Related Topics

- User groups

FTP filename requirements

FTP filenames are limited to standard ASCII characters.

This means that they cannot contain a blank space, quotation marks or \, /, *, ?, < or >, and are limited to 68 characters in length, including the file extension. The "/" character is only used as part of the FTP file directory information.

Enabling and disabling the FTP server using the webpages

The FTP server on the meter needs to be enabled for certain meter functionality, such as firmware upgrades or loading custom webpages.

NOTE: The FTP server is enabled by default. You may want to disable the FTP server during normal operation for security reasons.

1. Log in to the meter webpages using Product Master or Web Master credentials.
2. Click **Settings > Advanced Ethernet Settings**.
3. Set **FTP Server** to Enabled or Disabled.
4. Click **Save Changes** to save your changes to the meter.

Time and timekeeping

Setting the clock

The Clock setup screens allow you to set the meter’s date and time.

NOTE: You must always set or sync the meter time to UTC (GMT, Greenwich Mean Time), not local time. Use the **GMT Offset (h)** setup parameter to display the correct local time on the meter.

1. Navigate to **Maint > Setup**.
2. Enter the setup password (default is “0”), then press **OK**.
3. Navigate to **Clock**.
4. Move the cursor to point to the parameter you want to modify, then press **Edit**.
5. Modify the parameter as required, then press **OK**.
6. Move the cursor to point to the next parameter you want to modify, press **Edit**, make your changes, then press **OK**.
7. Press the up arrow to exit.
8. Press **Yes** to save your changes.

Parameter	Values	Description
Date	DD/MM/YY, MM/DD/YY, YY/MM/DD	Set the current date using the format displayed on screen, where DD = day, MM = month and YY = year.
Time	HH:MM:SS (24 hour format), HH:MM:SS AM or PM	Use the 24-hour format to set the current time in UTC (GMT).
Meter Time	GMT, Local	Select GMT to display the current time in UTC (Greenwich Mean Time zone). To display local time, set this parameter to Local, then use GMT Offset (h) to display local time in the proper time zone.
GMT Offset (h) ¹	+/- HH.0	Available only when Meter Time is set to Local, use this to display the local time relative to GMT. Set the sign to plus (+) if local time is ahead of GMT, or minus (-) if local time is behind GMT.

¹ Currently supports whole integers only.

To configure the clock using ION Setup, see the “PM5500” topic in the ION Setup online help or in the ION Setup device configuration guide, available for download at www.schneider-electric.com.

Setting the meter’s clock manually using the webpages

You can set the meter’s clock manually using the webpages.

NOTE: You can only set the time manually if **Enable Network Time Synchronization** is set to **No**.

1. Log in to the meter webpages using Product Master or Web Master credentials.
2. Click **Settings > Date/Time Settings**.
3. Use the dropdown lists to set the time and date you want to send to the meter.

NOTE: The default entry is the current date and time on the meter.

4. Click **Save changes** to save the time to your meter.

Configuring time and time synchronization using the webpages

You can configure time and time synchronization using the webpages.

1. Log in to the meter webpages using Product Master or Web Master credentials.
2. Click **Settings > Date/Time Settings**.
3. Click **Yes** beside Enable Network Time Synchronization if you want to use an SNTP server to synchronize the meter's clock.
 - a. Set the Poll Interval to specify how often the meter synchronizes over SNTP.
 - b. Enter the IP address for the Primary and Secondary SNTP servers.

NOTE: Last Successful Time Synchronization displays the date and time of the last synchronization over SNTP and the IP address of the server that sent the signal.
4. Enter the meter's clock settings.

Parameter	Values	Description
Time Zone Offset	UTC, UTC+/-H	Select UTC to display the current time in UTC (Greenwich Mean Time zone). To display local time, set this parameter to the UTC offset for your local time. For example, to display the local standard time in San Fransisco on the meter, select UTC-8. NOTE: You must either enable automatic daylight savings time adjustment or manually update this setting to account for daylight savings time.
Enable Automatic Daylight Savings Time Adjustment	Yes, No	Set this to Yes to automatically update the time to account for daylight savings time then enter the start and end date and time for daylight savings time.
Daylight Savings Time Begins / Daylight Savings Time Ends	—	Select the start and end date and time for daylight savings time in the meter's location.

Logging

Data log

The meter is shipped from the factory with data logging enabled for selected values.

Typically, delivered energy (kWh, kVARh and kVAh) is logged by default, but you can configure the meter to record other measurements, such as received energy, input metering accumulations and peak demand values from previous demand intervals.

Setting up the data log

You can select up to 14 items to record in the data log and the frequency (logging interval) that you want those values updated

Use ION Setup to configure data logging.

<i>NOTICE</i>
DATA LOSS Save the contents of the data log before configuring it. Failure to follow these instructions can result in data loss.

1. Start ION Setup and open your meter in setup screens mode (**View > Setup Screens**). See the ION Setup Help for instructions.
2. Double-click **Data Log #1**.
3. Set up the logging frequency and measurements/data to log.
4. Click **Send** to save the changes to the meter.

Parameter	Values	Description
Status	Enable, Disable	Set this parameter to enable or disable data logging in the meter.
Interval	1 minute, 5 minutes, 10 minutes, 15 minutes, 30 minutes, 1 hour, 24 hours	Select a time value to set the logging frequency.
Channels	Items available for logging can vary based on the meter type.	Select an item to record from the "Available" column, then click the double-right arrow button to move the item to the "Selected" column. To remove an item, select it from the "Selected" column then click the double-left arrow button.

Saving the data log contents using ION Setup

You can use ION Setup to save the contents of the data log.

1. Start ION Setup and open your meter in data screens mode (**View > Data Screens**). See the ION Setup help for instructions.
2. Double-click **Data Log #1** to retrieve the records.

- Once the records have finished uploading, right-click anywhere in the viewer and select **Export CSV** from the popup menu to export the entire log.

NOTE: To export only selected records in the log, click the first record you want to export, hold down the SHIFT key and click the last record you want to export, then select **Export CSV** from the popup menu.

- Navigate to the folder where you want to save the data log file, then click **Save**.

Setting up device log exports using the webpages

You can set up the meter to export its logs to a web server, either on a schedule or manually.

NOTE: Device log export times can vary, depending on the number of records to export. To avoid long log export times, consider reducing the logging frequency for the recorded items or selecting a more frequent log export schedule (e.g., weekly instead of monthly).

- Click **Settings > Device Log Export**.
- Click **Yes** to enable HTTP device log export.
- Set the frequency and configure the schedule as required.
 - Daily: select Daily to set the meter data log export to once a day. Use the Time of Day field to select what time the data log export occurs each day.
 - Weekly: select Weekly to set the meter data log export to once a week. Use the Time of Day and Day of the Week fields to select what time and day the data log export occurs each week.
 - Monthly: select Monthly to set the meter data log export to once a month. Use the Time of Day and Day of the Month fields to select what time and day the data log export occurs each month.

NOTE: You can leave the default settings if you are exporting the data logs manually.

- Configure the HTTP parameters as appropriate.

You can use the **Test HTTP** button to test the meter connection to the web server.

- Click **Save** changes to send and save the new settings to the meter if you are configuring an export schedule, or click **Manual Export** to export the data logs immediately.

Log export HTTP parameters available using the webpages

Parameter	Description
Server IP Address ¹	Enter the IP address of the server for the data log export.
Server TCP Port ¹	Enter the server port number for HTTP communications.
Proxy Server IP Address ¹	Enter the proxy server IP address, if required by your network.
Proxy Server TCP Port ¹	Enter the proxy server TCP port number, if required by your network.
PATH	Enter the network path of the folder where the data logs are to be exported.
Field Name	Enter the name of the exported data log.
Host Name	If using a virtual host name, enter the name here.
Username	Enter the username for accessing the server.
Password	Enter the password for accessing the server.

¹Contact your local network administrator for parameter values.

Alarm log

Alarm records are stored in the meter's alarm history log.

You can use the meter's display or a web browser to view the alarm history log.

Related Topics

- Accessing the meter webpages
- Active alarms list and alarm history log

Maintenance log

The meter records maintenance-type events such as changes to meter setup.

You can use a web browser to view the contents of the maintenance log.

Related Topics

- Accessing the meter webpages

Inputs / outputs

I/O ports

The meter is equipped with digital I/O ports.

The meter has:

- four (4) digital input ports (S1 to S4), and
- two (2) Form A digital output ports (D1 and D2).

After you wire the meter's digital I/O ports, you can configure these ports so you can use the meter to perform I/O functions.

Related Topics

- Device specifications

Digital input applications

Digital inputs are typically used for monitoring the status of external contacts or circuit breakers. They can also be used for pulse counting or input metering applications, such as WAGES (water, air, gas, electricity, steam) monitoring.

Digital input wiring considerations

The meter's digital inputs require an external voltage source to detect the digital input's on/off state.

The meter detects an on state if the external voltage appearing at the digital input is within its operating range.

WAGES monitoring

WAGES monitoring allows you to record and analyze all energy sources and utilities usage.

Your energy system may use several different types of energy. For example, you may consume steam or compressed air for industrial processes, electricity for lights and computers, water for cooling and natural gas for heating. WAGES monitoring collects the usage information from all these different energy sources to enable a more complete energy analysis.

WAGES information can help you:

- Identify losses or inefficiencies.
- Modify demand to reduce costs.
- Optimize energy source usage.

WAGES example

This example shows WAGES monitoring for a water flow meter.

You can connect your meter's digital input to a transducer that sends a pulse for every 15 kiloliters (4000 US Gal) of water. After configuring an input metering channel and assigning it to the digital input, the meter is able to detect and record the incoming pulses. An energy management system can then use the information from the meter to perform WAGES analysis.

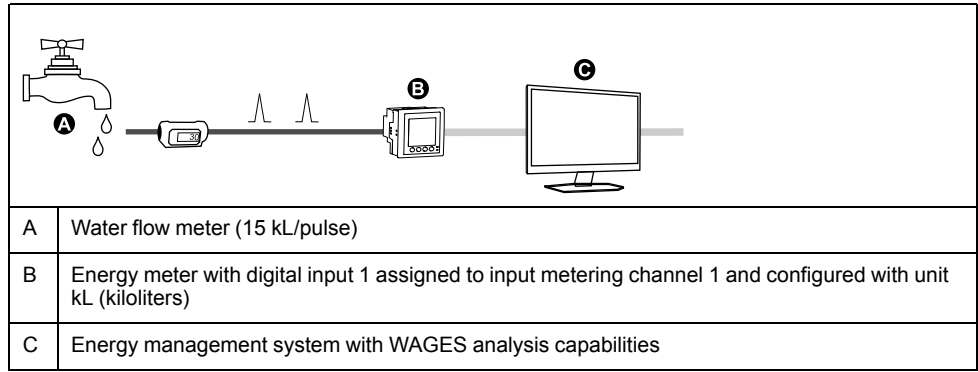

Configuring digital inputs using ION Setup

You can use ION Setup to configure the digital input ports (S1 to S4).

1. Start ION Setup.
2. Connect to your meter.
3. Navigate to **I/O configuration > I/O Setup**.
4. Select a digital input to configure and click **Edit**.

The setup screen for that digital input is displayed.

5. Configure the setup parameters as required.
6. Click **Send** to save your changes.

Digital input setup parameters

Parameter	Values	Description
Label	—	Use this field to change the default label and assign a descriptive name to this digital input.
Control Mode	Normal, Demand Sync, Input Metering, Multi-Tariff	This field displays how the digital input functions. <ul style="list-style-type: none"> • Normal: the digital input is either associated with a digital input alarm, or it is not associated with another meter function. The meter counts and records the number of incoming pulses normally. • Demand Sync: the digital input is associated with one of the input sync demand functions. The meter uses the incoming pulse to synchronize its demand period with the external source. • Input Metering: the digital input is associated with one of the input metering channels. The meter counts and records the number of incoming pulses and related consumption data associated with the pulses. • Multi-Tariff: the digital input is associated with the multi-tariff function.
Debounce	0 to 1000	Debounce is the time delay that compensates for mechanical contact bounce. Use this field to set how long (in milliseconds) the external signal must remain in a certain state to be considered a valid state change. Allowable values are increments of 10 (i.e., 10, 20, 30, etc., up to 1000 ms).
Associations	—	This field displays additional information if the digital input is already associated with another meter function.

Related Topics

- Synchronized demand
- Input mode overview
- Input metering

Configuring digital inputs using the display

You can use the display to configure the digital input ports (S1 to S4).

NOTE: It is recommended you use ION Setup to configure the digital inputs, as setup parameters that require text entry can only be modified using ION Setup.

1. Navigate to **Maint > Setup**.
2. Enter the setup password (default is "0"), then press **OK**.
3. Navigate to **I/O > D In**.
4. Move the cursor to point to the digital input you want to set up, then press **Edit**.
5. Move the cursor to point to the parameter you want to modify, then press **Edit**.
NOTE: If **Edit** is not displayed, it means the parameter is either read-only or can only be modified through software.
6. Modify the parameter as required, then press **OK**.
7. Move the cursor to point to the next parameter you want to modify, press **Edit**, make your changes, then press **OK**.
8. Press the up arrow to exit. Press **Yes** to save your changes.

Digital input setup parameters available using the display

Parameter	Values	Description
Label	—	This can be modified only through software. Use this field to assign names to the digital inputs (S1 to S4).
Debounce Time (ms)	0 to 1000	Debounce is the time delay that compensates for mechanical contact bounce. Use this field to set how long (in milliseconds) the external signal must remain in a certain state to be considered a valid state change. Allowable values are increments of 10 (i.e., 10, 20, 30, etc., up to 1000 ms).
Control Mode	Normal, Demand Sync, Input Metering, Multi-Tariff	This field displays how the digital input functions. <ul style="list-style-type: none"> • Normal: the digital input is either associated with a digital input alarm, or it is not associated with another meter function. The meter counts and records the number of incoming pulses normally. • Demand Sync: the digital input is associated with one of the input sync demand functions. The meter uses the incoming pulse to synchronize its demand period with the external source. • Input Metering: the digital input is associated with one of the input metering channels. The meter counts and records the number of incoming pulses and related consumption data associated with the pulses. • Multi-Tariff: the digital input is associated with the multi-tariff function.

Related Topics

- Synchronized demand
- Input mode overview
- Input metering

Input metering

Your meter’s digital inputs can be used to count pulses from transducers and convert the pulses to energy measurements.

Your meter’s input metering channels count pulses received from the digital inputs assigned to that channel. The incoming pulses are used in calculating and measuring consumption data (e.g., BTU, kWh, L, kg). Each channel must have the following values configured to match the pulse data:

- Pulse Weight: the pulses per unit value.
- Unit Code: the unit of measure associated with the monitored value.
- Demand Code: for time-based values (such as kWh), this provides the associated demand units (kW) for demand calculations; for other values (such as kg), this can be configured to provide rate information (kg/h or kg/s).
- Mode: whether a pulse is based on a complete pulse or a transition.

For example, if each complete pulse represents 125 Wh, you can configure for Wh pulsing as follows:

- Pulse Weight = pulses/Wh = 1/125 = 0.008

- Unit Code = Wh
- Demand Code = kW (this is automatically set)
- Mode = pulse

If you want to configure for kWh pulsing, you must adjust the pulse weight calculation and unit code as follows:

- Pulse Weight = pulses/kWh = 1/0.125 = 8
- Unit Code = kWh

Configuring input metering using ION Setup

You can use ION Setup to configure the input metering channels.

1. Start ION Setup.
2. Connect to your meter.
3. Navigate to **I/O configuration > Input metering**
4. Select an input metering channel to configure and click **Edit**.

The **Channel Setup** screen is displayed.

5. Enter a descriptive name for the metering channel's **Label**.
6. Configure the input metering parameters as required.
7. Click **Send** to save your changes.

Parameter	Values	Description
Label	—	Use this field to change the default label and assign a descriptive name to this input metering channel.
Pulse Weight	0 to 99.99999	Use this field to specify the quantity or value each pulse represents.
Units	No units, Wh, kWh, MWh, VARh, kVARh, MVARh, VAh, kVAh, MVAh, gal, BTU, L, m ³ , MCF, lbs, kg, klbs, Therm	Select the unit of measurement associated with the monitored value.
Rate	Varies (based on the units selected)	For time-based values (such as kWh), this provides the associated demand units (kW) for demand calculations. For other values (such as kg), this can be configured to provide rate information (kg/h).
Mode	Pulse or Transition	Set Mode to Pulse to count only complete pulses. Set Mode to Transition to count each ON-to-OFF or OFF-to-ON status change.
Available Inputs / Assigned Inputs	Digital input DI1 to DI4	Select the digital input from the Available inputs box and use the right arrow button to assign the input metering channel to that digital input.

Configuring input metering using the display

You can use the meter's display to configure the input metering channels.

NOTE: It is recommended you use ION Setup to configure input metering, as setup parameters that require text entry can only be modified using ION Setup.

1. Navigate to **Maint > Setup**.
2. Enter the setup password (default is "0"), then press **OK**.
3. Navigate to **I/O > Inp Mtr**.

4. Move the cursor to point to the input metering channel you want to set up, then press **Edit**.
5. Move the cursor to the parameter you want to modify, then press **Edit**.
NOTE: If **Edit** is not displayed, it means the parameter is either read-only or can only be modified through software.
6. Modify the parameter as required, then press **OK**.
7. Press the up arrow to exit. Press **Yes** to save your changes.

Parameter	Values	Description
Label	—	Use this field to change the default label and assign a descriptive name to this input metering channel.
Pulse Weight	0 to 99.99999	Use this field to specify the quantity or value each pulse represents.
Units	No units, Wh, kWh, MWh, VARh, kVARh, MVARh, VAh, kVAh, MVAh, gal, BTU, L, m ³ , MCF, lbs, kg, klbs, Therm	Select the unit of measurement associated with the monitored value.
Rate	Varies (based on the units selected)	For time-based values (such as kWh), this provides the associated demand units (kW) for demand calculations. For other values (such as kg), this can be configured to provide rate information (kg/h).
Mode	Pulse or Transition	Set Mode to Pulse to count only complete pulses. Set Mode to Transition to count each ON-to-OFF or OFF-to-ON status change.
Available Inputs / Assigned Inputs	Digital input DI1 to DI4	Select the digital input from the Available inputs box and use the right arrow button to assign the input metering channel to that digital input.

Demand measurements for input metering

The demand codes available for input metering are based on the unit code selected when you configure input metering on your meter.

Input metering unit and demand codes

Unit Code	Demand Code	Description
None	None	Default setting for the input metering channels
Wh	kW	Watt-hour, kiloWatt-hour and MegaWatt-hour measurements are converted to calculate demand in kW.
kWh		
MWh		
VARh	kVAR	VAR-hour, kiloVAR-hour and MegaVAR-hour measurements are converted to calculate demand in kVAR.
kVARh		
MVARh		
VAh	kVA	VA-hour, kiloVA-hour and MegaVA-hour measurements are converted to calculate demand in kVA.
kVAh		
MVAh		
gal	GPH, GPM	Select GPH to set rate to gallons per hour or GPM to set it to gallons per minute.
BTU	BTU/h	BTU (British thermal unit) energy measurements are set to calculate BTUs per hour consumption rate.
L	l/hr, l/min	Select liters per hour or per minute consumption rate.
m ³	m ³ /hr, m ³ /s, m ³ /min	Select cubic meters per hour, per second, or per minute consumption rate.

Input metering unit and demand codes

Unit Code	Demand Code	Description
MCF	cfm	Thousand cubic foot volume measurements are converted to calculate cubic feet per minute consumption rate.
lbs klbs	lb/hr	Kilopounds (klbs) measurements are converted to calculate pounds per hour consumption rate.
kg	kg/hr	Kilogram measurements are set to calculate kilogram per hour consumption rate.
Therm	Thm/h	British therm (equivalent to 100,000 BTU) heat measurements are set to calculate therm per hour consumption rate.

Viewing input metering data through the meter's display

You can use the meter's display to view input metering data.

1. Navigate to **Energy > Inp Mtr > Dmd**.
2. Select an input metering channel to view the input metering data.

NOTE: The display shows accumulation values from 0 to 99999. The display rolls over to zero when the accumulated value reaches 100,000 and starts incrementing again.

Digital output applications

Digital outputs are typically used in switching applications, for example, to provide on/off control signals for switching capacitor banks, generators, and other external devices and equipment.

The digital output can also be used in demand synchronization applications, where the meter provides pulse signals to the input of another meter to control its demand period. The digital output can also be used in energy pulsing applications, where a receiving device determines energy usage by counting the kWh pulses coming from the meter's digital output port.

Related Topics

- Setting up demand calculations

Digital output application example

You can connect one of your meter's digital outputs to a relay that switches on a generator and the other digital output to send a demand sync pulse to other meters.

In the following example, the first meter (Meter 1) controls and sets the demand period (900 seconds) of the other meters (Meter 2, Meter 3, Meter 4) through the output pulse occurring at the end of the first meter's demand interval.

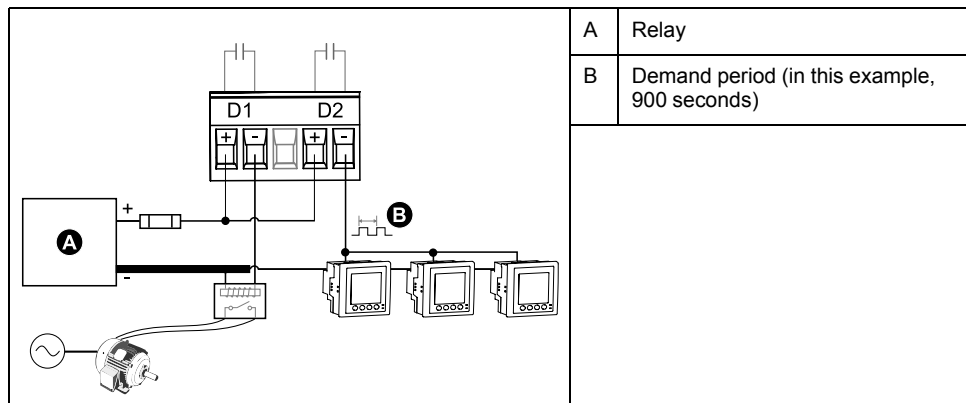

Configuring digital outputs using ION Setup

You can use ION Setup to configure the digital outputs (D1 and D2).

1. Start ION Setup.
2. Connect to your meter.
3. Navigate to **I/O configuration > I/O Setup**.
4. Select a digital output to configure and click **Edit**.
The setup screen for that digital output is displayed.
5. Enter a descriptive name for the digital output in the **Label** field.
6. Configure the other setup parameters as required.

7. Click **Send** to save your changes.

Digital output setup parameters available using ION Setup

Parameter	Values	Description
Label	—	Use this field to change the default label and assign a descriptive name to this digital output.
Control Mode	External, Demand Sync, Alarm, Energy	This field displays how the digital output functions. <ul style="list-style-type: none"> External: the digital output is controlled remotely either through software or by a PLC using commands sent through communications. Demand Sync: the digital output is associated with one of the demand systems. The meter sends a pulse to the digital output port at the end of every demand interval. Alarm: the digital input is associated with the alarm system. The meter sends a pulse to the digital output port when the alarm is triggered. Energy: The digital output is associated with energy pulsing. When this mode is selected, you can select the energy parameter and the set the pulse rate (pulses/kW).
Behavior Mode	Normal, Timed, Coil Hold	<ul style="list-style-type: none"> Normal: this mode applies when control mode is set to External or Alarm. The digital output remains in the ON state until an OFF command is sent by the computer or PLC. Timed: the digital output remains ON for the period defined by the On Time setup register. Coil Hold: this mode applies when control mode is set to External or Alarm. For a unary alarm that is associated with a digital output, you must set Behavior Mode to Coil Hold. The output turns on when the “energize” command is received and turns off when the “coil hold release” command is received. In the event of a control power loss, the output remembers and returns to the state it was in when control power was lost.
On Time (s)	0 to 9999	This setting defines the pulse width (ON time) in seconds.
Select Dmd System	Power, Current, Input metering	Applies when Control Mode is set to Demand Sync. Select the demand system to monitor.
Select Alarms	All available alarms	Applies when Control Mode is set to Alarm. Select one or more alarms to monitor.
Associations	—	This field displays additional information if the digital output is already associated with another meter function.

Configuring digital outputs using the display

You can use the display to configure the digital outputs.

NOTE: It is recommended you use ION Setup to configure the digital outputs, as setup parameters that require text entry can only be modified using software.

1. Navigate to **Maint > Setup**.
2. Enter the setup password, then press **OK**.
3. Navigate to **I/O > D Out**.
4. Move the cursor to point to the digital output you want to set up, then press **Edit**.

5. Edit the parameters as required.
 - a. Move the cursor to point to the parameter you want to modify, then press **Edit**
 - b. Modify the parameter as required, then press **OK**.
 - c. Move the cursor to point to the next parameter you want to modify, press **Edit**, make your changes, then press **OK**.

NOTE: If **Edit** is not displayed, it means the parameter is either read-only or can only be modified through software.
6. Press the up arrow to exit. Press **Yes** to save your changes.

Setting	Option or range	Description
Label	—	This can be modified only through software. Use this field to change the default label and assign a descriptive name to this digital output.
Control Mode	External, Demand Sync, Alarm, Energy	This field displays how the digital output functions. <ul style="list-style-type: none"> • External: the digital output is controlled remotely either through software or by a PLC using commands sent through communications. • Demand Sync: the digital output is associated with one of the demand systems. The meter sends a pulse to the digital output port at the end of every demand interval. • Alarm: the digital input is associated with the alarm system. The meter sends a pulse to the digital output port when the alarm is triggered. • Energy: The digital output is associated with energy pulsing. When this mode is selected, you can select the energy parameter and the set the pulse rate (pulses/kW).
Behavior Mode	Normal, Timed, Coil Hold	<ul style="list-style-type: none"> • Normal: this mode applies when control mode is set to External or Alarm. The digital output remains in the ON state until an OFF command is sent by the computer or PLC. • Timed: the digital output remains ON for the period defined by the On Time setup register. • Coil Hold: this mode applies when control mode is set to External or Alarm. For a unary alarm that is associated with a digital output, you must set Behavior Mode to Coil Hold. The output turns on when the “energize” command is received and turns off when the “coil hold release” command is received. In the event of a control power loss, the output remembers and returns to the state it was in when control power was lost.
On Time (s)	0 to 9999	This setting defines the pulse width (ON time) in seconds.
Select Dmd System	Power, Current, Input Metering	Applies when Control Mode is set to Demand Sync. Select the demand system to monitor.
Select Alarms	All available alarms	Applies when Control Mode is set to Alarm. Select one or more alarms to monitor.

Energy pulsing

You can configure the meter’s energy pulsing LED or digital output for energy pulsing applications.

When the LED is set to energy pulsing, the meter sends a readable pulse or signal based on the measured energy. This pulse can be used for accuracy verification or as an input to another energy monitoring system. You must calculate your pulse values as either pulses per kWh or as kWh per pulse, as defined by your meter, and set the energy value as delivered or received active, reactive, or apparent energy.

Related Topics

- Alarm / energy pulsing LED

Configuring the alarm / energy pulsing LED using the display

You can use the display to configure your meter’s LED for alarming or energy pulsing applications.

NOTE: The alarm / energy pulsing LED on the PM5561 is permanently set for energy pulsing.

1. Navigate to **Maint > Setup**.
2. Enter the setup password (default is “0”), then press **OK**.
3. Navigate to **I/O > LED**.
4. Move the cursor to point to the parameter you want to modify, then press **Edit**.
5. Press the plus or minus buttons to modify the parameter as required, then press **OK**.
6. Press the up arrow to exit. Press **Yes** to save your changes.

Setting	Option or range	Description
Mode	Disabled, Alarm, Energy	Disabled turns off the LED completely. Alarm sets the LED for alarm notification. Energy sets the LED for energy pulsing.
Parameter	Active Del, Active Rec, Active Del + Rec, Reactive Del, Reactive Rec, Reactive Del + Rec, Apparent Del, Apparent Rec, Apparent Del + Rec	Select which accumulated energy channel to monitor and use for energy pulsing. This setting is ignored when the LED mode is set to Alarm.
Pulse Wt. (p/k_h)	1 to 9999999	When configured for energy pulsing, this setting defines how many pulses are sent to the LED for every 1 kWh, 1 kVARh or 1kVAh accumulated energy. This setting is ignored when the LED mode is set to Alarm.

Configuring the alarm / energy pulsing LED or digital output for energy pulsing using ION Setup

You can use ION Setup to configure your meter’s alarm / energy pulsing LED or digital output for energy pulsing.

NOTE: The alarm / energy pulsing LED on the PM5561 is permanently set for energy pulsing and cannot be disabled or used for alarms.

1. Start ION Setup.
2. Connect to your meter.
3. Navigate to **I/O configuration > Energy Pulsing**.
4. Select the LED or a digital output to configure and click **Edit**.

The setup screen is displayed.

5. Enter a descriptive name for the digital output’s **Label**.
6. Configure the other setup parameters as required.

7. Click **Send** to save your changes.

Alarm / energy pulsing setup parameters available using ION Setup

Parameter	Values	Description
Mode	LED: Off, Alarm, Energy Digital output: External, Energy	LED: <ul style="list-style-type: none"> Off disables the LED. Alarm sets the LED for alarm notification. Energy sets the LED for energy pulsing. Digital output: <ul style="list-style-type: none"> Energy: associates the digital output with energy pulsing. External: disassociates the digital output from energy pulsing.
Pulse rate (pulses/kW)	1 to 9999999	When configured for energy pulsing, this defines how many pulses are sent to the LED for every 1 kWh, 1 kVARh or 1kVAh of accumulated energy.
Parameter	Active Energy Delivered, Active Energy Received, Active Energy Del+Rec, Reactive Energy Delivered, Reactive Energy Received, Reactive Energy Del+Rec, Apparent Energy Delivered, Apparent Energy Received, Apparent Energy Del+Rec	Select which accumulated energy channel to monitor and use for energy pulsing.

Resets

Meter resets

Resets allow you to clear various accumulated parameters stored on your meter or reinitialize the meter or meter accessories.

Meter resets clear your meter’s onboard data logs and other related information. Resets are typically performed after you make changes to the meter’s basic setup parameters (such as frequency, VT/PT or CT settings) to clear invalid or obsolete data in preparation for putting the meter into active service.

Meter Initialization

Meter Initialization is a special command that clears the meter’s logged data, counters and timers.

It is common practice to initialize the meter after its configuration is completed, before adding it to an energy management system.

After configuring all the meter setup parameters, navigate through the different meter display screens and make sure the displayed data is valid then perform meter initialization.

Performing global resets using the display

Global resets allow you to clear all data of a particular type, such as all energy values or all minimum/maximum values.

1. Navigate to **Maint > Reset**.
2. Move the cursor to point to **Global Reset**, then press **Select**.
3. Move the cursor to point to the parameter you want to reset, then press **Reset**.

Option	Description
Meter Initialization	Clears all data listed in this table (energy, demand, min/max values, counters, logs, timers and input metering data).
Energies	Clears all accumulated energy values (kWh, kVARh, kVAh).
Demands	Clears all the demand registers.
Min/Max	Clears all the minimum and maximum registers.
Alarm Counts & Logs	Clears all the alarm counters and alarm logs.
I/O Counts & Timers	Clears all the I/O counters and resets all the timers.
Input Metering	Clears all input metering energy data.

4. Enter the reset password (default is “0”), then press **OK**.
5. Press **Yes** to confirm the reset or **No** to cancel and return to the previous screen.

To perform resets using ION Setup, see the “PM5500” topic in the ION Setup online help or in the ION Setup device configuration guide, available from www.schneider-electric.com.

Performing single resets using the display

Single resets allow you clear data only in a specific register or register type.

Single resets are often combined to allow you to clear all data of a similar type, for example, a kWh, kVAR and kVA reset may be combined into an energy reset that clears all of the meter's energy logs.

1. Navigate to **Maint > Reset**.
2. Move the cursor to point to **Single Reset**, then press **Select**.
3. Move the cursor to point to the parameter you want to reset, then press **Reset**.

If there are additional options for the parameter, press **Select**, move the cursor to point to the option you want, then press **Reset**.

4. Enter the reset password (default is "0"), then press **OK**.
5. Press **Yes** to confirm the reset or **No** to cancel and return to the previous screen.

Available single resets using the display

Parameter	Option	Description
Energy	Accumulated	Clears all accumulated energy values (kWh, kVARh, kVAh).
Demand	Power, Current, Input Metering	Select which demand registers to clear (power demand, current demand or input metering demand).
Alarms	Event Queue	Clears the alarm event queue register (active alarms list).
	History Log	Clears the alarm history log.
	Counters	Select Counters and then select which alarm counter to clear. See the Alarm counter reset options table.
Digital Inputs	Timers	Select Timers then select which digital input timer to clear (chose all or individual digital input timers): All Dig In Timers, Digital Input DI1, Digital Input DI2, Digital Input DI3, Digital Input DI4
	Counters	Select Counters then select which digital input counter to clear (chose all or individual digital input timers): All Dig In Counters, Digital Input DI1, Digital Input DI2, Digital Input DI3, Digital Input DI4
Digital Outputs	Timers	Select Timers then select which digital output timer to clear (chose all or individual digital input timers): All Dig Out Timers, Digital Output DO1, Digital Output DO2
	Counters	Select Counters then select which digital output counter to clear (chose all or individual digital input timers): All Dig Out Counters, Digital Output DO1, Digital Output DO2
Active Load Timer	—	Clears and restarts the load operation timer.
Multi-Tariff	—	Clears accumulated values in all tariff registers.
Input Metering	Reset All InpMtr, Reset InpMtr Chan 1, Reset InpMtr Chan 2, Reset InpMtr Chan 3, Reset InpMtr Chan 4	Select which input metering channel (InpMtr Chan) to clear (chose all or individual input metering channels).

To perform resets using ION Setup, see the "PM5500" topic in the ION Setup online help or in the ION Setup device configuration guide, available from www.schneider-electric.com.

Alarm counter reset options

These are the alarm counter resets available on your device.

Alarm counter	Option	Description
Current	Over Current, Ph	Select which alarm counter register to reset from the current alarm condition counters.
	Under Current, Ph	
	Over Current, N	
	Over Current, Gnd	

Alarm counter	Option	Description
Voltage	Over Voltage, L-L	Select which alarm counter register to reset from the voltage alarm condition counters.
	Under Voltage, L-L	
	Over Voltage, L-N	
	Under Voltage, L-N	
	Over Voltage THD	
	Phase Loss	
Power	Over kW	Select which alarm counter to reset from the power alarm condition counters.
	Over kVAR	
	Over kVA	
Power Factor	Lead PF, True	Select which alarm counter register to reset from the power factor alarm conditions
	Lag PF, True	
	Lead PF, Disp	
	Lag PF, Disp	
Demand	Over kW Dmd, Pres	Select which alarm counter register to reset from the demand alarm condition counters.
	Over kW Dmd, Last	
	Over kW Dmd, Pred	
	Over kVAR Dmd, Pres	
	Over kVAR Dmd, Last	
	Over kVAR Dmd, Pred	
	Over kVA Dmd, Pres	
	Over kVA Dmd, Last	
	Over kVA Dmd, Pred	
Frequency	Over Frequency	Select which alarm counter register to reset from the frequency alarm condition counters.
	Under Frequency	
Unary	Meter Powerup	Select which alarm counter register to reset from the unary alarm condition counters.
	Meter Reset	
	Meter Diagnostic	
	Phase Reversal	
Digital Inputs	Digital Alarm DI1	Select which alarm counter register to reset from the digital input alarm condition counters.
	Digital Alarm DI2	
	Digital Alarm DI3	
	Digital Alarm DI4	
Cust1s	Custom Alarm 1	Select which alarm counter register to reset from the custom 1-second alarm condition counters.
	Custom Alarm 2	
	Custom Alarm 3	
	Custom Alarm 4	
	Custom Alarm 5	
Logic	Logic Alarm 1	Select which alarm counter register to reset from the logic alarm condition counters.
	Logic Alarm 2	
	Logic Alarm 3	
	Logic Alarm 4	
	Logic Alarm 5	
	Logic Alarm 6	

Alarm counter	Option	Description
	Logic Alarm 7	
	Logic Alarm 8	
	Logic Alarm 9	
	Logic Alarm 10	

Alarms

Alarms overview

An alarm is the meter's means of notifying you when an alarm condition is detected, such as an error or an event that falls outside of normal operating conditions.

You can configure your meter to generate and display high, medium and low priority alarms when predefined events are detected in the meter's measured values or operating states. Your meter also logs the alarm event information. Your meter comes with many alarms. Some alarms are preconfigured, while others need to be configured before your meter can generate alarms. Your meter's default alarms can be customized, as needed, such as changing the priority. You can create custom alarms using the advanced features of your meter.

Alarm types

Your meters supports a number of different alarm types.

Type	Number
Unary	4
Digital	4
Standard	29
Logic	10
Custom	5

Unary alarms

A unary alarm is the simplest type of alarm — it monitors a single behavior, event or condition.

Available unary alarms

Your meter has a set of 4 unary alarms.

Alarm label	Description
Meter Power Up	Meter powers on after losing control power.
Meter Reset	Meter resets for any reason.
Meter Diagnostic	Meter's self-diagnostic feature detects a problem.
Phase Reversal	Meter detects a phase rotation different than expected.

Digital alarms

Digital alarms monitor the ON or OFF state of the meter's digital inputs.

Digital alarm with setpoint delay

To prevent false triggers from erratic signals, you can set up pickup and dropout time delays for the digital alarm.

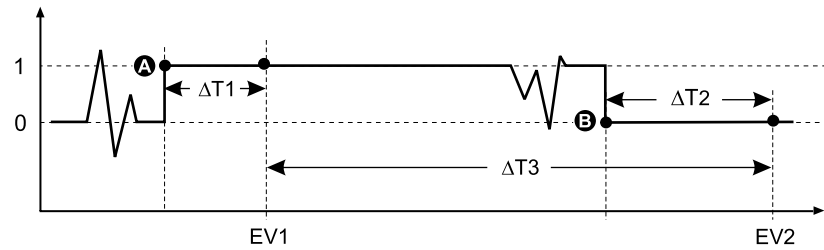

A	Pickup setpoint (1 = ON)	$\Delta T2$	Dropout time delay (in seconds)
B	Dropout setpoint (0 = OFF)	EV2	End of alarm condition
$\Delta T1$	Pickup time delay (in seconds)	$\Delta T3$	Alarm duration (in seconds)
EV1	Start of alarm condition		

NOTE: To prevent filling the alarm log with nuisance alarm trips, the digital alarm is automatically disabled if the digital input changes state more than 4 times in one second or more than 10 times in ten seconds.

Available digital alarms

Your meter has a set of 4 digital alarms.

Alarm label	Description
Digital Alarm S1	Digital input 1
Digital Alarm S2	Digital input 2
Digital Alarm S3	Digital input 3
Digital Alarm S4	Digital input 4

Standard alarms

Standard alarms are setpoint-driven alarms monitor certain behaviors, events or unwanted conditions in your electrical system.

Standard alarms have a detection rate equal to the 50/60 meter cycle, which is nominally 1 second if the meter's frequency setting is configured to match the system frequency (50 or 60 Hz).

Many of the standard alarms are three-phase alarms. Alarm setpoints are evaluated for each of the three phases individually, but the alarm is reported as a single alarm. The alarm pickup occurs when the first phase exceeds the alarm pickup magnitude for the pickup time delay. The alarm is active as long as any phase remains in an alarm state. The alarm dropout occurs when the last phase drops below the dropout magnitude for the dropout time delay.

Example of over and under setpoint (standard) alarm operation

The meter supports over and under setpoint conditions on standard alarms.

A setpoint condition occurs when the magnitude of the signal being monitored crosses the limit specified by the pickup setpoint setting and stays within that limit for a minimum time period specified by the pickup time delay setting.

The setpoint condition ends when the magnitude of the signal being monitored crosses the limit specified by dropout setpoint setting and stays within that limit for a minimum time period specified by dropout time delay setting.

Over setpoint

When the value rises above the pickup setpoint setting and remains there long enough to satisfy the pickup time delay period ($\Delta T1$), the alarm condition is set to ON. When the value falls below the dropout setpoint setting and remains there long enough to satisfy the dropout time delay period ($\Delta T2$), the alarm condition is set to OFF.

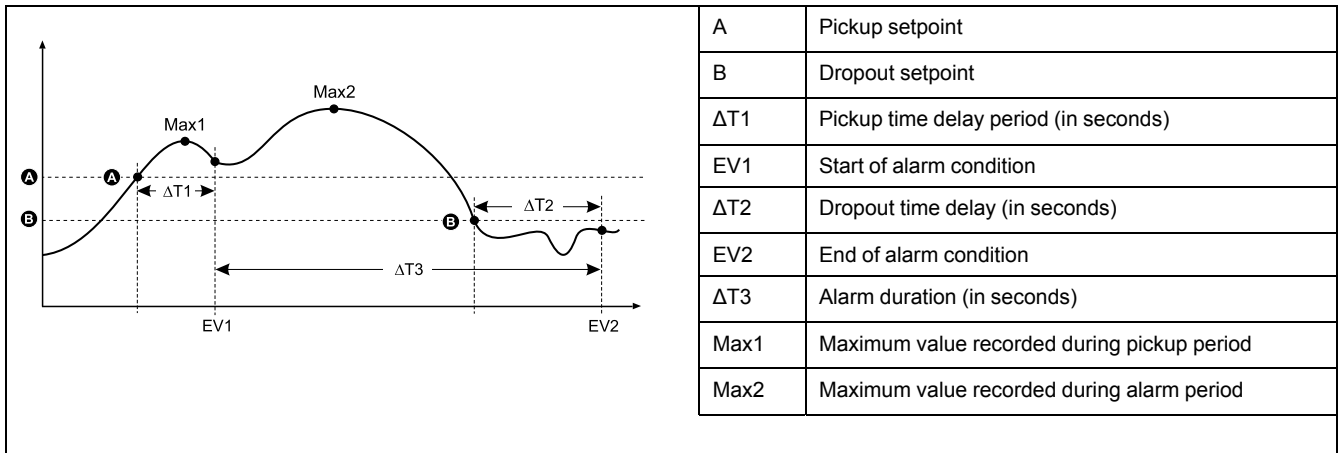

The meter records the date and time when the alarm event starts (EV1) and when it ends (EV2). The meter also performs any task assigned to the event, such as operating a digital output. The meter also records maximum values (Max1, Max2) before, during or after the alarm period.

Under setpoint

When the value falls below the pickup setpoint setting and remains there long enough to satisfy the pickup time delay period ($\Delta T1$), the alarm condition is set to ON. When the value rises above the dropout setpoint setting and remains there long enough to satisfy the dropout time delay period ($\Delta T2$), the alarm condition is set to OFF.

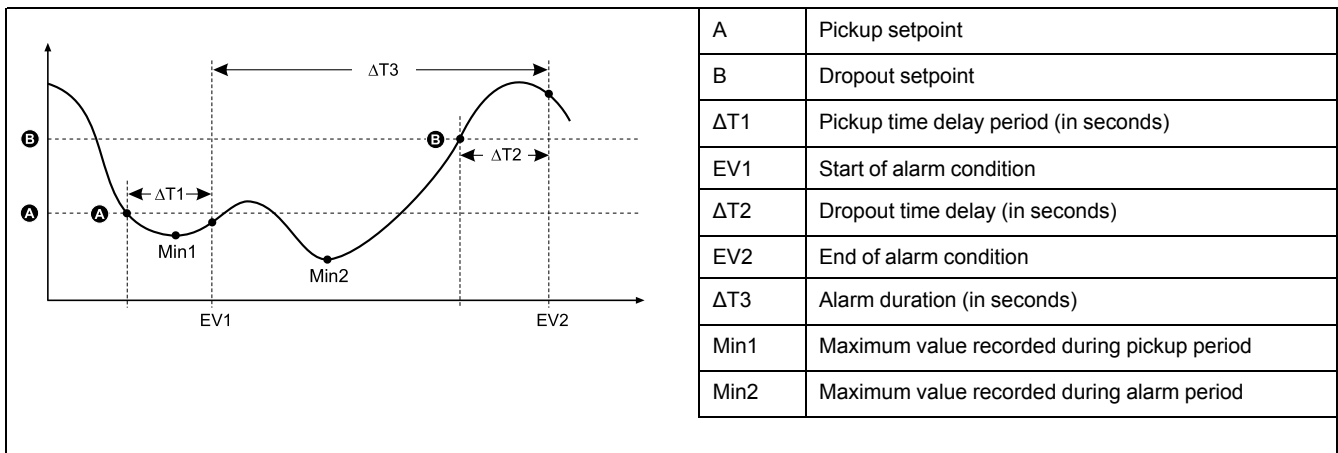

The meter records the date and time when the alarm event starts (EV1) and when it ends (EV2). The meter also performs any task assigned to the event, such as operating a digital output. The meter also records minimum values (Min1, Min2) before, during or after the alarm period.

Maximum allowable setpoint

The meter is programmed to help prevent user data entry errors, with set limits for the standard alarms.

The maximum setpoint value you can enter for some of the standard alarms depends on the voltage transformer ratio (VT ratio), current transformer ratio (CT ratio), system type (i.e., number of phases) and/or the maximum voltage and maximum current limits programmed at the factory.

NOTE: VT ratio is the VT primary divided by the VT secondary and CT ratio is the CT primary divided by the CT secondary.

Standard alarm	Maximum setpoint value
Over Phase Current	(maximum current) x (CT ratio)
Under Phase Current	(maximum current) x (CT ratio)
Over Neutral Current	(maximum current) x (CT ratio) x (number of phases)
Over Ground Current	(maximum current) x (CT ratio)
Over Voltage L-L	(maximum voltage) x (VT ratio)
Under Voltage L-L	(maximum voltage) x (VT ratio)
Over Voltage L-N	(maximum voltage) x (VT ratio)
Under Voltage L-N	(maximum voltage) x (VT ratio)
Over Active Power	(maximum voltage) x (maximum current) x (number of phases)
Over Reactive Power	(maximum voltage) x (maximum current) x (number of phases)
Over Apparent Power	(maximum voltage) x (maximum current) x (number of phases)
Over Present Active Power Demand	(maximum voltage) x (maximum current) x (number of phases)
Over Last Active Power Demand	(maximum voltage) x (maximum current) x (number of phases)
Over Predicted Active Power Demand	(maximum voltage) x (maximum current) x (number of phases)
Over Present Reactive Power Demand	(maximum voltage) x (maximum current) x (number of phases)
Over Last Reactive Power Demand	(maximum voltage) x (maximum current) x (number of phases)
Over Predicted Reactive Power Demand	(maximum voltage) x (maximum current) x (number of phases)
Over Present Apparent Power Demand	(maximum voltage) x (maximum current) x (number of phases)
Over Last Apparent Power Demand	(maximum voltage) x (maximum current) x (number of phases)
Over Predicted Apparent Power Demand	(maximum voltage) x (maximum current) x (number of phases)
Over Voltage Unbalance	(maximum voltage) x (VT ratio)
Phase Loss	(maximum voltage) x (VT ratio)

Available standard alarms

Your meter has a set of standard alarms.

NOTE: Some alarms do not apply to all power system configurations. For example, line-to-neutral voltage alarms cannot be enabled on 3-phase delta systems. Some alarms use the system type and the VT or CT ratio to determine the maximum allowed setpoint.

Alarm label		Valid range and resolution		Units
ION Setup	Display	ION Setup	Display	
Over Phase Current	Over Current, Ph	0.000 to 99999.000	0 to 99999	A
Under Phase Current	Under Current, Ph	0.000 to 99999.000	0 to 99999	A
Over Neutral Current	Over Current, N	0.000 to 99999.000	0 to 99999	A
Over Ground Current	Over Current, Gnd	0.000 to 99999.000	0 to 99999	A
Over Voltage L-L	Over Voltage, L-L	0.00 to 999999.00	0 to 999999	V
Under Voltage L-L	Under Voltage, L-L	0.00 to 999999.00	0 to 9999999	V
Over Voltage L-N	Over Voltage, L-N	0.00 to 999999.00	0 to 9999999	V
Under Voltage L-N	Under Voltage L-N	0.00 to 999999.00	0 to 9999999	V
Over Active Power	Over kW	0.0 to 9999999.0	0 to 9999999	kW
Over Reactive Power	Over kVAR	0.0 to 9999999.0	0 to 9999999	kVAR

Alarm label		Valid range and resolution		Units
ION Setup	Display	ION Setup	Display	
Over Apparent Power	Over kVA	0.0 to 9999999.0	0 to 9999999	kVA
Leading True PF	Lead PF, True	-1.00 to -0.01 and 0.01 to 1.00		—
Lagging True PF	Lag PF, True	-1.00 to -0.01 and 0.01 to 1.00		—
Leading Disp PF	Lead PF, Disp	-1.00 to -0.01 and 0.01 to 1.00		—
Lagging Disp PF	Lag PF, Disp	-1.00 to -0.01 and 0.01 to 1.00		—
Over Present Active Power Demand	Over kW Dmd, Pres	0.0 to 9999999.0	0 to 9999999	kW
Over Last Active Power Demand	Over kW Dmd, Last	0.0 to 9999999.0	0 to 9999999	kW
Over Predicted Active Power Demand	Over kW Dmd, Pred	0.0 to 9999999.0	0 to 9999999	kW
Over Present Reactive Power Demand	Over kVAR Dmd, Pres	0.0 to 9999999.0	0 to 9999999	kVAR
Over Last Reactive Power Demand	Over kVAR Dmd, Last	0.0 to 9999999.0	0 to 9999999	kVAR
Over Predicted Reactive Power Demand	Over kVAR Dmd, Pred	0.0 to 9999999.0	0 to 9999999	kVAR
Over Present Apparent Power Demand	Over kVA Dmd, Pres	0.0 to 9999999.0	0 to 9999999	kVA
Over Last Apparent Power Demand	Over kVA Dmd, Last	0.0 to 9999999.0	0 to 9999999	kVA
Over Predicted Apparent Power Demand	Over kVA Dmd, Pred	0.0 to 9999999.0	0 to 9999999	kVA
Over Frequency	Over Frequency	0.000 to 99.000		Hz
Under Frequency	Under Frequency	0.000 to 99.000		Hz
Over Voltage Unbalance	Over Voltage Unbal	0.000 to 9999999.000	0 to 9999999	V
Over Voltage THD	Over Voltage THD	0.000 to 99		%
Phase Loss	Phase Loss	0.00 to 9999999.00	0 to 9999999	—

Power factor (PF) alarms

You can set up a Leading PF or Lagging PF alarm to monitor when the circuit's power factor goes above or below the threshold you specify.

The Leading PF and Lagging PF alarms use the power factor quadrants as the values on the y-axis, with quadrant II on the lowest end of the scale, followed by quadrant III, quadrant I, and finally quadrant IV on the highest end of the scale.

Quadrant	PF values	Lead/Lag
II	0 to -1	Leading (capacitive)
III	-1 to 0	Lagging (inductive)
I	0 to 1	Lagging (inductive)
IV	1 to 0	Leading (capacitive)

Leading PF alarm

The Leading PF alarm monitors an over setpoint condition.

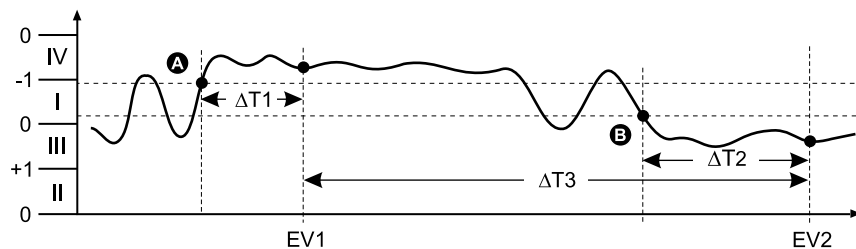

A	Pickup setpoint	$\Delta T2$	Dropout time delay (in seconds)
B	Dropout setpoint	EV2	End of alarm condition
$\Delta T1$	Pickup delay period (in seconds)	$\Delta T3$	Alarm duration (in seconds)
EV1	Start of alarm condition		

Lagging PF alarm

The Lagging PF alarm monitors an under setpoint condition.

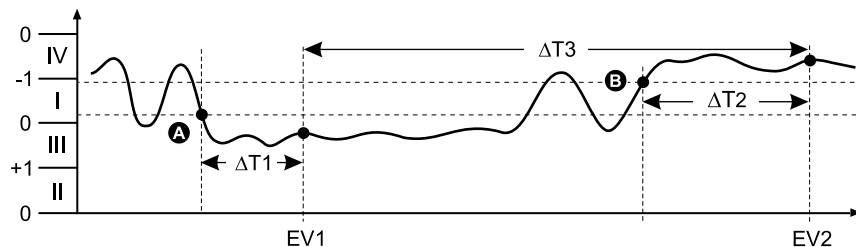

A	Pickup setpoint	$\Delta T2$	Dropout time delay (in seconds)
B	Dropout setpoint	EV2	End of alarm condition
$\Delta T1$	Pickup delay period (in seconds)	$\Delta T3$	Alarm duration (in seconds)
EV1	Start of alarm condition		

Phase loss alarm

The phase loss alarm is an under setpoint alarm that monitors the voltages on a 3-phase system and triggers the alarm when one or two phases fall below the pickup setpoint setting and remain there long enough to satisfy the pickup time delay period.

When all of the phases rise above the dropout setpoint setting and remain there long enough to satisfy the dropout time delay period, the alarm condition is set to OFF.

Logic alarms

A logic alarm is used to monitor up to four different inputs or parameters.

The logic alarm is tripped when the individual states of all the inputs (A, B, C, D) cause the output (Y) of a logic operation to be true.

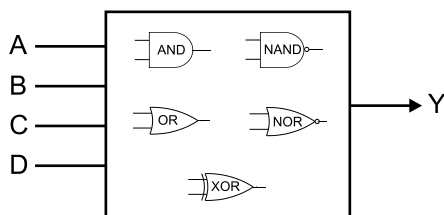

The logic alarm inputs can only be linked using software.

Custom alarms

Custom alarms (Cust1s) are setpoint-driven alarms, similar to the standard (1-Sec) alarms.

A custom alarm's input parameters and setpoint subtypes can only be configured using software.

Custom alarm parameter list

You can configure custom alarms to monitor over and under conditions on a variety of different parameters.

The pickup setpoint and dropout setpoint limits are set to -999999 to 999999.

Alarm parameter	Unit	Alarm parameter	Unit
Current A	A	Active Energy Delivered	kW
Current B	A	Active Energy Received	kW
Current C	A	Active Energy Delivered+Received	kW
Current N	A	Active Energy Delivered-Received	kW
Current G	A	Reactive Energy Delivered	kVAR
Current Avg	A	Reactive Energy Received	kVAR
Current Unbalance A	%	Reactive Energy Delivered+Received	kVAR
Current Unbalance B	%	Reactive Energy Delivered-Received	kVAR
Current Unbalance C	%	Apparent Energy Delivered	kVA
Current Unbalance Worst	%	Apparent Energy Received	kVA
Voltage A-B	V	Apparent Energy Delivered+Received	kVA
Voltage B-C	V	Apparent Energy Delivered-Received	kVA
Voltage C-A	V	Input Metering CH 01 Accumulation	—
Voltage L-L Avg	V	Input Metering CH 02 Accumulation	—
Voltage A-N	V	Input Metering CH 03 Accumulation	—
Voltage B-N	V	Input Metering CH 04 Accumulation	—
Voltage C-N	V	Active Power Last Demand	kW
Voltage L-N Avg	V	Active Power Present Demand	kW
Voltage Unbalance A-B	%	Active Power Predicted Demand	kW
Voltage Unbalance B-C	%	Reactive Power Last Demand	kVAR
Voltage Unbalance C-A	%	Reactive Power Present Demand	kVAR
Voltage Unbalance L-L Worst	%	Reactive Power Predicted Demand	kVAR
Voltage Unbalance A-N	%	Apparent Power Last Demand	kVA
Voltage Unbalance B-N	%	Apparent Power Present Demand	kVA
Voltage Unbalance C-N	%	Apparent Power PredicatedDemand	kVA
Voltage Unbalance L-N Worst	%	Current A Last Demand	A
Active Power A	kW	Current A Present Demand	A
Active Power B	kW	Current A Precidated Demand	A
Active Power C	kW	THD Current A	%
Active Power Total	kW	THD Current B	%
Reactive Power A	kVAR	THD Current C	%
Reactive Power B	kVAR	THD Current N	%
Reactive Power C	kVAR	THD Current G	%

Alarm parameter	Unit
Reactive Power Total	kVAR
Apparent Power A	kVA
Apparent Power B	kVA
Apparent Power C	kVA
Apparent Power Total	kVA
Frequency	Hz
Temperature	°C

Alarm parameter	Unit
thd Current A	%
thd Current B	%
thd Current C	%
thd Current N	%
thd Current G	%
Min Freq	Hz
Max Active Power A	kW
Max Total Demand Distortion	%
Max Freq	Hz

Alarm priorities

Each alarm has a priority level that you can use to distinguish between events that require immediate action and those that do not require action.

Alarm priority	Alarm display notification and recording method			
	Alarm LED	Alarm icon	Alarm details	Alarm logging
High	Blinks while the alarm is active.	Blinks while the alarm is active. Alarm icon remains displayed until acknowledged.	Click Details to display what caused the alarm to pickup or drop off. Click Ack to acknowledge the alarm.	Recorded in alarm log.
Medium	Blinks while the alarm is active.	Blinks while the alarm is active.	Click Details to display what caused the alarm to pickup or drop off.	Recorded in alarm log.
Low	Blinks while the alarm is active.	Blinks while the alarm is active.	Click Details to display what caused the alarm to pickup or drop off.	Recorded in alarm log.
None	No activity	None	None	Recorded in event log only.

NOTE: The alarm LED notification only occurs if the alarm / energy pulsing LED is configured for alarming.

Multiple alarm considerations

If multiple alarms with different priorities are active at the same time, the display shows the alarms in the order they occurred.

Related Topics

- Alarm display and notification

Alarm setup overview

You can use the meter display or ION Setup to configure unary, digital or standard (1-Sec) alarms. To configure logic and custom alarms, you must use ION Setup.

If you make changes to the basic power meter setup, all alarms are disabled to prevent undesired alarm operation. If you configure Standard or Custom alarm setpoints using the display, any decimals previously configured using ION Setup are lost.

NOTICE

UNINTENDED EQUIPMENT OPERATION

- Verify all alarm settings are correct and make adjustments as necessary.
- Re-enable all configured alarms.

Failure to follow these instructions can result in incorrect alarm functions.

Built-in error-checking

ION Setup dynamically checks incorrect setup combinations. When you enable an alarm, you must set up the pickup and dropout limits to acceptable values first in order to exit the setup screen.

Setting up alarms using the display

You can use the display to create and set up standard (1-Sec), unary and digital alarms, and to configure logic and custom alarms after they are created in ION Setup.

NOTE:

- You must use ION Setup to create logic and custom (Cust1s) alarms. After the alarm is created, you can use ION Setup or the display to modify the alarm parameters.
- It is recommended that you use ION Setup to configure standard (1-Sec) alarms. ION Setup supports a higher resolution to allow you to specify more decimal places when setting up the pickup setpoint and dropout setpoint values for certain measurements.

1. Navigate to the alarms setup menu screens and select the alarm you want to set up.
2. Configure the setup parameters as explained in the different alarm setup sections.

NOTE: If you used ION Setup to program decimal values on a standard (1-Sec) alarm, do not use the meter display to make subsequent changes to any alarm parameters (including enable/disable), as doing so will cause removal of all decimals previously programmed through ION Setup.

3. Click **Yes** to save the changes to the meter when prompted.

Setting up alarms using ION Setup

You can use ION Setup to create and set up alarms.

1. Start ION Setup and connect to your meter.
2. Open the **Alarming** screen.
3. Select the alarm you want to configure and click **Edit**.
4. Configure the setup parameters as explained in the different alarm setup sections.

See the ION Setup Device Configuration guide for more information.

Unary alarm setup parameters

Configure the unary alarm setup parameters as required.

ION Setup controls are shown in parentheses.

Setting	Option or range	Description
Enable	Yes (checked) or No (cleared)	This enables or disables the alarm.
Priority	High, Medium, Low, None	This sets the alarm priority and notification options.
Select Dig Output (Outputs)	None Digital Output D1 Digital Output D2 Digital Output D1 & D2	Select the digital output(s) you want to control when the alarm is triggered.

Digital alarm setup parameters

Configure the digital alarm setup parameters as required.

ION Setup controls are shown in parentheses.

Setting	Option or range	Description
Enable	Yes (checked) or No (cleared)	This enables or disables the alarm.
Priority	High, Medium, Low, None	This sets the alarm priority and notification options.
Pickup Setpoint (Setpoint Pickup)	On, Off	Use this setting to control when to trip the alarm, based on the state of the digital input (On or Off).
Pickup Time Delay (Delay)	0 to 999999	This specifies the number of seconds the digital input must be in the alarm pickup state before the alarm is tripped.
Dropout Time Delay (Setpoint Dropout Delay)	0 to 999999	This specifies the number of seconds the digital input must be out of the alarm pickup state before the alarm turns off.
Select Dig Output (Outputs)	None Digital Output D1 Digital Output D2 Digital Output D1 & D2	Select the digital output(s) you want to control when the alarm is triggered.

Standard (1-Sec) alarm setup parameters

Configure the standard alarm setup parameters as required.

ION Setup controls are shown in parentheses.

NOTE: It is recommended that you use ION Setup to configure standard (1-Sec) alarms. ION Setup supports a higher resolution to allow you to specify more decimal places when setting up the pickup setpoint and dropout setpoint values for certain measurements.

Setting	Option or range	Description
Enable	Yes (checked) or No (cleared)	This enables or disables the alarm.
Priority	High, Medium, Low, None	This sets the alarm priority and notification options.
Pickup Setpoint (Pickup Limit)	Varies depending on the standard alarm you are setting up	This is the value (magnitude) you define as the setpoint limit for triggering the alarm. For “over” conditions, this means the value has gone above the Pickup limit. For “under” conditions, this means the value has gone below the Pickup limit.
Pickup Time Delay (Delay)	0 to 999999	This specifies the number of seconds the signal must stay above the pickup setpoint (for “over” conditions), or below the pickup setpoint (for “under” conditions) before the alarm is tripped.
Dropout Setpoint (Dropout Limit)	Varies depending on the standard alarm you are setting up	This is the value (magnitude) you define as the limit for dropping out of the alarm condition. For “over” conditions, this means

Setting	Option or range	Description
		the value has gone below the Dropout limit. For "under" conditions, this means the value has gone above the Pickup limit.
Dropout Time Delay (Delay)	0 to 999999	This specifies the number of seconds the signal must stay below the dropout setpoint (for "over" conditions), or above the dropout setpoint (for "under" conditions) before the alarm condition is ended.
PU Set Point Lead/Lag (Lead, Lag)	Lead or Lag	Applies to PF (power factor) alarms only. Use this to set the PF value and quadrant to set the pickup setpoint for an over PF condition (PF Leading) or under PF condition (PF Lagging).
DO Set Point Lead/Lag (Lead, Lag)	Lead or Lag	Applies to PF (power factor) alarms only. Use this to set the PF value and quadrant to set the dropout setpoint for an over PF condition (PF Leading) or under PF condition (PF Lagging).
Select Dig Output (Outputs)	None Digital Output D1 Digital Output D2 Digital Output D1 & D2	Select the digital output(s) you want to control when the alarm is triggered.

Related Topics

- Power factor (PF)
- Standard alarms

Setting up logic alarms using ION Setup

Use ION Setup to configure logic alarms.

NOTE: You must first configure the alarms you want to use as inputs to a logic alarm. For example, if you use a standard (1-Sec) alarm as one of the inputs, you must set up its setpoint pickup, dropout and delay parameters.

1. Select the logic alarm you want to set up, then click **Edit**.
2. Select the alarms you want to use as inputs to the logic alarm.
3. Click the double-arrow button to move the selected alarm(s) to the **Selected (max 4)** box, then click **OK**.
4. Configure the rest of the alarm setup parameters.
5. Click **OK** then **Send** to save your changes to the meter.

Logic alarm setup parameters

Configure the logic alarm setup parameters as required.

Setting	Option or range	Description
Enable	Yes (checked) or No (cleared)	This enables or disables the alarm.
Label	Logic Alarm 1 to Logic Alarm 10 (default labels)	ION Setup lets you modify the default label so it more clearly identifies your logic alarm. You can only use letters, numbers and underscores. Spaces are not allowed.
Type	AND	Output of AND operation is True only if all inputs are True.
	NAND	Output of NAND operation is True if one or more inputs are False.
	OR	Output of OR operation is True if one or more inputs are True.
	NOR	Output of NOR operation is True only if all inputs are False.
	XOR	Output of XOR operation is True if only one input is True, and all other inputs are False.

Setting	Option or range	Description
Priority	High, Medium, Low, None	This sets the alarm priority and notification options.
Select Dig Output (Outputs)	None, Digital Output D1, Digital Output D2, Digital Output D1 & D2	Select the digital output(s) you want to control when the alarm is triggered.

Logic alarm setup error prompts

Both the meter and ION Setup have error-checking provisions, and alert you with an error message if there is an error in the logic alarm setup.

You are alerted if the following actions are attempted:

- The output of a logic alarm is used as an input to itself.
- The same source is duplicated as another input on the same logic alarm.
- The source register used is invalid or is a nonexistent parameter.

Setting up custom alarms using ION Setup

Use ION Setup to configure custom (Cust1s) alarms.

1. Select the custom alarm you want to set up, then click **Enable** to display the available setup options.
2. Use the dropdown list to select the parameter you want to set for your custom alarm.
3. Use the **Label** box to define a name for your custom alarm.
4. Use the dropdown list to select the setpoint condition you want to monitor:
 - Over: Alarm condition occurs when the value goes above the pickup setpoint setting.
 - Under: Alarm condition occurs when the value goes below the pickup setpoint setting.
 - Over (absolute): Alarm condition occurs when the absolute value goes above the pickup setpoint setting.
 - Under (absolute): Alarm condition occurs when the absolute value goes below the pickup setpoint setting.
5. Configure the rest of the alarm setup parameters.
6. Click **OK** then **Send** to save your changes to the meter

Custom alarm setup parameters

Configure the custom alarm parameters as required.

Setting	Option or range	Description
Enable	Yes (checked) or No (cleared)	This enables or disables the alarm.
Setpoint Pickup	Varies depending on the custom alarm you are setting up	This is the value (magnitude) you define as the setpoint limit for triggering the alarm. For "over" conditions, this means the value has gone above the Pickup limit. For "under" conditions, this means the value has gone below the Pickup limit.
Delay (Setpoint Pickup)	0 to 999999	This specifies the number of seconds the signal must stay above the pickup setpoint (for "over" conditions), or below the pickup setpoint (for "under" conditions) before the alarm is tripped.
Setpoint Dropout	Varies depending on the custom alarm you are setting up	This is the value (magnitude) you define as the limit for dropping out of the alarm condition. For "over" conditions, this means the value has gone below the Dropout limit. For "under" conditions, this means the value has gone above the Pickup limit.

Setting	Option or range	Description
Delay (Setpoint Dropout)	0 to 999999	This specifies the number of seconds the signal must stay below the dropout setpoint (for "over" conditions), or above the dropout setpoint (for "under" conditions) before the alarm condition is ended.
Priority	High, Medium, Low, None	This sets the alarm priority and notification options.
Select Dig Output (Outputs)	None, Digital Output D1, Digital Output D2, Digital Output D1 & D2	Select the digital output(s) you want to control when the alarm is triggered.

Related Topics

- Standard alarms

LED alarm indicator

You can use the meter's alarm / energy pulsing LED as an alarm indicator.

When set to detect alarms, the LED blinks to indicate an alarm condition.

NOTE: The alarm / energy pulsing LED on the PM5561 is permanently set for energy pulsing and cannot be used for alarms.

Related Topics

- Alarm / energy pulsing LED
- Alarm display and notification
- Alarm priorities

Configuring the LED for alarms using the display

You can use the meter display to configure the alarm / energy pulsing LED for alarming.

NOTE: The alarm / energy pulsing LED on the PM5561 is permanently set for energy pulsing and cannot be used for alarms.

1. Navigate to the **LED** setup menu screen.
2. Set the mode to **Alarm**, then press **OK**.
3. Press the up arrow to exit. Press **Yes** to save your changes.

Configuring the LED for alarms using ION Setup

You can use ION Setup to configure your meter's LED for alarming.

NOTE: The alarm / energy pulsing LED on the PM5561 is permanently set for energy pulsing and cannot be used for alarms.

1. Open ION Setup and connect to your meter. See the ION Setup Help for instructions.
2. Navigate to **I/O configuration > Energy Pulsing**.
3. Select **Front Panel LED** and click **Edit**.
4. Set the control mode to **Alarm**.
5. Click **Send** to save your changes.

Alarm display and notification

The meter notifies you when an alarm condition is detected.

Alarm icon

When a low, medium or high priority alarm is tripped, this symbol appears at the top right corner of the display screen, indicating that an alarm is active:



For high priority alarms, the alarm icon remains displayed until you acknowledge the alarm.

Alarm / energy pulsing LED

If configured for alarming, the alarm / energy pulsing LED also flashes to indicate the meter has detected an alarm condition.

Alarm screens

If your meter is equipped with a display, you can use the buttons to navigate to the alarm setup or display screens.

Active alarms

When a pickup event occurs, the active alarm list appears on the meter display's Active Alarms screen. Press **Detail** to see more event information.

Alarm details

Details about the alarms can be viewed using:

- the active alarms (Active), alarm history (Hist), alarm counters (Count) and unacknowledged alarms (Unack) screens on the meter display, or
- the Active Alarms and Alarm History screens on the meter webpages.

Related Topics

- Notification icons
- Alarm priorities

Email on alarm

You can configure the meter to send an email or email-to-text message when alarm conditions are detected, and set the alarm types and priorities that trigger the email.

Both the email and the text messages provide the label and the address of the meter's main webpage.

- The text message notifies you that there is an alarm condition. You can then view the active alarms on the meter webpages for details.
- The email message contains additional information about the alarm condition, such as the alarm name, type, value, priority, and date and time.

In addition, if the connection to the email server is lost, the meter sends a message once the connection is reestablished so you can check if you missed any alarm notifications.

Example email

Schneider Electric		
High and Medium and Low Priority Alarms: Power Meter		
12/05/2014 09:40:27		
From: Schneider Electric		
Alarm Summary Report		
HTTP://000.000.000.000		
Alarm	Value	Comment
09:39:19 12/05/2014 Low Digital Alarm S1	1	Pickup
09:39:19 12/05/2014 High Digital Alarm S4	1	Pickup
09:39:31 12/05/2014 High Digital Alarm S4	0	Dropout
09:39:31 12/05/2014 Low Digital Alarm S1	0	Dropout
09:40:00 12/05/2014 Medium Over Current, Phase - Current A	8.0000	Pickup
09:40:00 12/05/2014 Medium Over Current, Phase - Current B	8.0000	Pickup
09:40:00 12/05/2014 Medium Over Current, Phase - Current C	8.0000	Pickup

Implementation and default configuration

The email on alarm feature is disabled by default.

Use the meter's webpages to enable the feature, configure up to 3 email or email-to-text addresses and set up related parameters.

Email on alarm examples

There are some differences between the email and email-to-text message functionality for the email on alarm feature.

Overview of the email on alarm feature: email

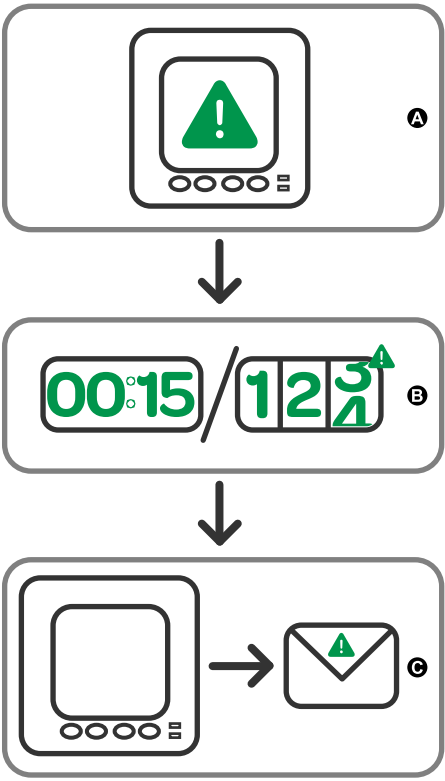
	A	A new alarm occurs on the meter.
	B	The meter starts counting the email hold time and the maximum emails per message.
	C	When the email hold time or the maximum emails per message is reached, whichever is first, the meter sends an email with the details for all alarms that have occurred since the first alarm.

Overview of the email on alarm feature: email-to-text

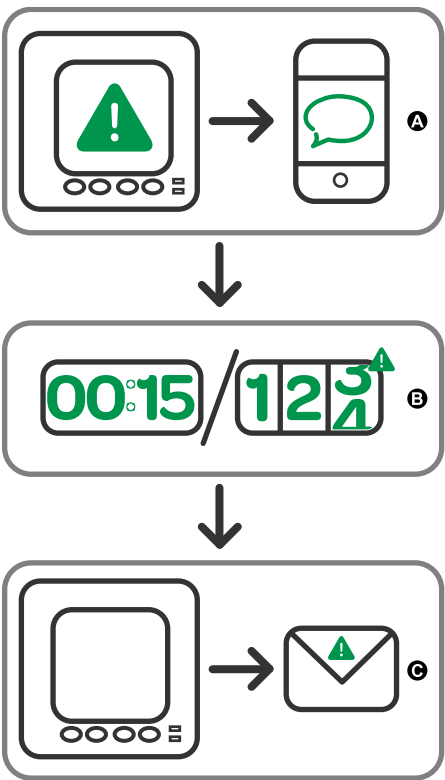
	A	A new alarm occurs on the meter. The meter sends a text message to inform you of the alarm.
	B	The meter starts counting the email hold time and the maximum emails per message. No new texts are sent for alarms that occur during this period.
	C	When the email hold time or the maximum emails per message is reached, whichever is first, the meter sends an email with the details for all alarms that have occurred since the first alarm.

Configuring the email on alarm feature using the webpages

Use the meter webpages to configure the email on alarm feature.

In order to configure the feature, you need the connection information for your SMTP server, available from your network administrator.

NOTE: The email is sent in the language set for the Product Master account on the meter webpages.

1. Log in to the meter webpages using Product Master or Web Master credentials.
2. Click **Settings > Email On Alarm Settings**.
3. Configure one or more email addresses to send the alarm notification to.
 - a. Click **Yes** to enable that email address.
 - b. Select **Email** or **Text** from the **Email/Text** list.
 - c. Type a valid email address in the **Email Address** field.

NOTE: To receive text notifications, you must enter the email-to-text address in the correct format. Contact your mobile provider for the correct format for your mobile device.
4. Configure the types of alarms you want to receive notifications for.
 - Click **Yes** beside the alarm priorities that you want to receive notifications for: High, Medium and Low.
 - Click **Yes** beside the types of alarms you want to receive notifications for: Pickup, Dropout and Diagnostic.
5. Configure the SMTP server parameters.
6. Click **Send Test Email** to validate the email on alarm configuration.

If configured correctly, you will receive an email or text informing you that you successfully configured the email settings.

7. Configure the advanced email on alarm parameters, if required.

NOTE: You can click **Defaults** to reset the advance parameters to their default values.

Email on alarm SMTP server parameters available using the webpages

Parameter	Values	Description
SMTP Server IP address	—	Enter the IP address of the SMTP server used to send the email, available from your network administrator
SMTP Port Number	—	The port on the SMTP server that the meter the email to
SMTP Server Requires Login	Yes / No	Click Yes if the SMTP server requires login then type in the username and password for the server

Email on alarm advanced parameters available using the webpages

Parameter	Values	Description
Max Alarms per Email	1 – 60	The maximum number of alarms the meter accumulates before sending an email. After the meter accumulates the maximum number, it sends an email even if the max email hold time has not elapsed.
Max Email Hold Time	1 – 300	The maximum time, in seconds, that the meter waits before sending an email. After the max email hold time elapses, the meter sends any accrued alarms even if there are less than the Max Alarms per Email.
Server Connection Timeout	30 – 600	The maximum time, in seconds, that the meter tries to connect to the SMTP server.
Email Retry Attempts	1 – 100	The number of times the meter tries to send an email if the first attempt is unsuccessful.

Related Topics

- Alarm priorities

Active alarms list and alarm history log

Each occurrence of a low, medium or high priority alarm is stored in the active alarms list and recorded in the alarm history log.

The active alarm list holds 40 entries at a time. The list works as a circular buffer, replacing old entries as new entries over 40 are entered into the active alarms list. The information in the active alarms list is volatile and reinitializes when the meter resets.

The alarm history log holds 40 entries. The log also works as a circular buffer, replacing old entries with new entries. The information in the alarm history log is nonvolatile and is retained when the meter resets.

Viewing active alarm details using the display

When an alarm condition becomes true (alarm = ON), the alarm is displayed on the active alarms screen.

Alarms are displayed sequentially in the order of their occurrence, regardless of priority. The alarm details show the date and time of the alarm event, the type of event (for example, pickup or unary), which phase the alarm condition was detected on, and the value that caused the alarm condition.

NOTE: Alarm details are not available if the alarm priority is set to None.

The alarm details (for low, medium and high priority alarms) are also recorded in the alarm history log.

1. Navigate to **Alarm > Active**.
2. Select the alarm you want to view (the latest ones appear on top).
3. Press **Detail**.

NOTE: For unacknowledged high priority alarms, the Ack option appears on this screen. Press **Ack** to acknowledge the alarm, or return to the previous screen if you do not want to acknowledge the alarm.

Viewing alarm history details using the display

The alarm history log keeps a record of active alarms and past alarms.

When an active alarm condition becomes false (alarm = OFF), the event is recorded in the alarm history log and alarm notification (alarm icon, alarm LED) is turned off.

Alarms are displayed sequentially in the order of their occurrence, regardless of priority. The alarm details show the date and time of the alarm event, the type of event (for example, dropout or unary), which phase the alarm condition was detected on, and the value that caused the alarm condition to turn ON or OFF.

NOTE: Alarm details are not available if the alarm priority is set to None.

1. Navigate to **Alarm > Hist**.
2. Select the alarm you want to view (the latest ones appear on top).
3. Press **Detail**.

NOTE: For unacknowledged high priority alarms, the **Ack** option appears on this screen. Press **Ack** to acknowledge the alarm, or return to the previous screen if you do not want to acknowledge the alarm.

Viewing alarms counters using the display

Every occurrence of each type of alarm is counted and recorded in the meter.

NOTE: The alarm counters roll over to zero after reaching the value 9999.

1. Select **Alarm > Count**.

The **Alarms Counter** screen displays.

2. Scroll through the list to view the number of alarm occurrences for each type of alarm.

Acknowledging high-priority alarms using the display

You can use the meter display to acknowledge high-priority alarms.

1. Navigate to **Alarm > Unack**.
2. Select the alarm you want to acknowledge.
3. Press **Detail**.
4. Press **Ack** to acknowledge the alarm.
5. Repeat for other unacknowledged alarms.

Resetting alarms using ION Setup

Use ION Setup to reset alarms.

You can also reset alarms using the meter display.

1. Connect to your meter in ION Setup.
2. Open the **Meter Resets** screen.
3. Select the alarm parameters to clear and click **Reset**.

Related Topics

- Performing single resets using the display

Multi-tariffs

Multi-tariff overview

The multi-tariff feature allows you to set up different tariffs for storing energy values.

The energy values for different tariffs are stored in registers that correspond to each of those tariffs.

Multi-tariff example

The multi-tariff feature can be used when a utility has set up tariff schedules with different rates based on what day or time of day energy is consumed.

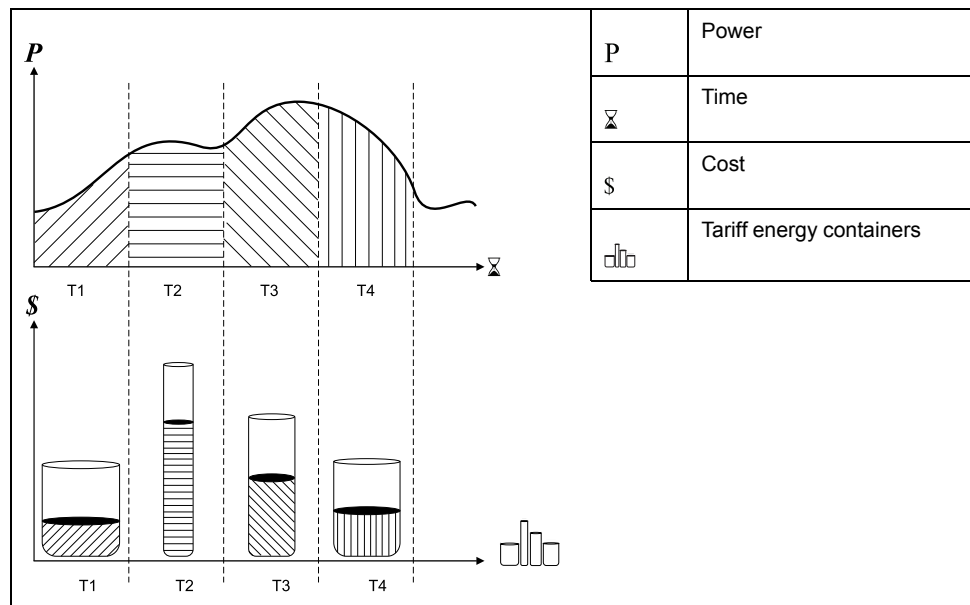

In the above illustration, the area under the power curve equals the energy consumed.

Typically, the utility sets tariff schedules so the cost of energy is higher during high demand or high energy consumption times. How these “tariff energy containers” are configured determines how fast these containers fill, which correlates to increasing energy costs. The price per kWh is lowest at tariff T1 and highest at tariff T2.

Multi-tariff implementation

The meter supports configuration of up to 8 different tariffs to measure and monitor energy usage that can be used in billing or cost applications.

There are different tariff modes you can use to determine what tariff is applied and when: Command mode, Time of Day mode, and Input mode.

Command mode overview

You can use command mode to send a Modbus command to the device which sets the active tariff.

The active tariff is applied to the measured energy until you send another Modbus command that sets a different tariff.

Search for your meter's Modbus register list at www.schneider-electric.com to download the Modbus map.

Time of day mode overview

Use time of day mode to create a tariff based on a schedule.

You can use this mode to create a tariff schedule that specifies where the meter stores energy or input metered data, based on the time of year (month, day), the type of day (every day, weekend, weekday or a specific day of the week), or time of day. The data collected from the different tariffs can then be used in energy audits or similar costing and budget planning purposes.

Time of day mode tariff validity

A valid time of day tariff has certain conditions and limitations.

- Each tariff must cover a unique time period (tariffs cannot overlap) but there can be periods with no tariff.
- Any number of tariffs, from none to the maximum number of tariffs, can be applied.
- Time of day tariffs do not adjust for daylight savings time.
- Time of day tariffs include February 29th in leap years (however, it is not recommended to have February 29th as a start or end date, as that tariff would be invalid for non-leap years).
- Except for leap years, tariff dates are not year-specific; if you wanted to create a tariff that starts on the first Monday in August, you need to enter the date for that year, then manually update the tariff information for the subsequent years.

Your device performs validation checks as you enter tariff information; it prompts you to change the information that you have entered or set the tariff to disabled if the tariff configuration is invalid. These checks can include:

- Start and end times must be different (for example, you cannot create a tariff that starts at 02:00 and also ends at 02:00).
- Start time can only be earlier than end time for tariffs that are applied every day. You can create a daily tariff that starts at 06:00 and ends at 02:00, but these times are only valid for the Everyday tariff and invalid for the other tariff types.
- Start day must be earlier than end day if the days are in the same month. You cannot create a tariff that starts June 15 and ends June 12.

Time of day tariff creation methods

You can create time of day tariffs using one of two methods, or a combination of these methods.

The two methods of creating tariffs are:

- Time of year tariffs divide the year into multiple sections (usually seasons), where each section has one or more day types. For example, an eight tariff configuration using this method could have Spring, Summer, Fall and Winter seasons that also use different weekend and weekday tariffs.
- Daily tariffs can divide days by day of the week, a weekday, a weekend, or every day, and can specify the time of day. For example, an eight tariff configuration could have every day in the year divided into three-hour tariff periods or could have four tariffs for weekends and four tariffs for weekdays.

You can combine these methods if, for example you wanted to create a tariff that applies on Mondays from January 1 to June 30, from 09:00 to 17:00. However, since only one tariff can be applied at any time, you cannot use an everyday or weekday tariff type because you already specified a tariff for the time periods 09:00 to 17:00.

Depending on how you configure the tariffs and the maximum number of tariffs supported by your meter, you may not be able to assign tariffs for the entire year, potentially leaving time gaps that do not have any tariff assigned to them.

Input mode overview

You can use input mode to have the device's digital inputs set which tariff is applied to the energy that is presently being consumed.

The number of different tariffs that can be applied is determined by the number of available digital inputs and the total number of tariffs supported by your device.

Digital input assignment for input control mode

You need to assign one or more digital inputs with non-exclusive associations to define the active tariff.

If a digital input is used for multi-tariff, it cannot be used for an exclusive association (such as Demand Sync or Input Metering), but digital inputs can be shared with a non-exclusive association (such as Alarms). To make a digital input available for setting tariffs, any conflicting associations must be manually removed at the source of the original association.

You cannot configure any digital input tariff if digital input 1 is not available for association. Likewise, digital input 2 must be available to select more than two tariffs.

The status of the digital inputs is used to calculate the binary value of the active tariff, where off = 0 and on = 1. The calculation of the number of tariffs value can differ, depending on the number of digital inputs that can be selected (i.e., inputs that can be associated with multi-tariff).

Digital input requirements for required number of tariffs

Number of tariffs required	Digital inputs required	
	Configuration 1	Configuration 2
1	1 (digital input 1)	1 (digital input 1)
2	1 (digital input 1)	2 (digital input 1 and 2)
3	2 (digital input 1 and 2)	2 (digital input 1 and 2)
4	2 (digital input 1 and 2)	3 (digital input 1, 2 and 3)
5	3 (digital input 1, 2 and 3)	3 (digital input 1, 2 and 3)
6	3 (digital input 1, 2 and 3)	3 (digital input 1, 2 and 3)
7	3 (digital input 1, 2 and 3)	3 (digital input 1, 2 and 3)
8	3 (digital input 1, 2 and 3)	4 (digital input 1, 2, 3 and 4)

Configuration 1: 8 tariff assignment using 3 digital inputs

NOTE: There is no inactive tariff with this configuration.

Tariff	Digital input 4	Digital input 3	Digital input 2	Digital input 1
T1	N/A	0	0	0
T2	N/A	0	0	1
T3	N/A	0	1	0
T4	N/A	0	1	1
T5	N/A	1	0	0

Tariff	Digital input 4	Digital input 3	Digital input 2	Digital input 1
T6	N/A	1	0	1
T7	N/A	1	1	0
T8	N/A	1	1	1

Configuration 2: 8 tariff assignment using 4 digital inputs

NOTE: Digital input configuration 0000 means there are no active tariffs (all tariffs are disabled).

NOTE: Any configuration above T8 (i.e., 1001 and higher) is invalid and therefore ignored by the meter (the active tariff does not change).

Tariff	Digital input 4	Digital input 3	Digital input 2	Digital input 1
None	0	0	0	0
T1	0	0	0	1
T2	0	0	1	0
T3	0	0	1	1
T4	0	1	0	0
T5	0	1	0	1
T6	0	1	1	0
T7	0	1	1	1
T8	1	0	0	0

Tariff setup

You can change tariffs and the tariff mode using the display and/or ION Setup.

You can change the tariff mode using the display. You can configure input mode and time of day mode using the display or ION Setup. It is recommended that you use ION Setup to configure time of day mode.

The active tariff is controlled based on the tariff mode.

- When the meter is set to command mode for tariffs, the active tariff is controlled by Modbus commands sent from your energy management system or other Modbus master.
- When the meter is set to input mode for tariffs, the active tariff is controlled by the status of the digital inputs.
- When the meter is set to time of day mode for tariffs, the active tariff is controlled by the day type, the start and end times, and the start and end dates.

Time of day mode tariff configuration considerations

The time of day tariff is not a calendar; the meter does not calculate the corresponding day of the week to a specific date, but February 29th is considered a valid date if you are programming the meter during a leap year.

When you enter tariff times using the display, be aware that the displayed minute value includes the entire minute. For example, an end time of 01:15 includes the time from 01:15:00 through 01:15:59. To create a tariff period that starts right after this, you must set the next tariff's start time to 01:16. Although it may appear that there is a gap between these tariffs, there is not.

NOTE: You must always set the tariff times to UTC (GMT, Greenwich Mean Time), not local time. The GMT Offset (h) setup parameter does not apply to tariff times.

Input mode tariff configuration considerations

Digital inputs are available for tariffs if they are not used, or if they are only associated with alarms (Normal). To make a digital input available, you must manually disconnect the conflicting association before configuring tariffs.

NOTE: You must always set the tariff times to UTC (GMT, Greenwich Mean Time), not local time. The GMT Offset (h) setup parameter does not apply to tariff times.

To configure the tariffs using ION Setup, see the “PM5500” topic in the ION Setup online help or in the ION Setup device configuration guide, available for download at www.schneider-electric.com.

Configuring input mode tariffs using the display

Use the display to configure input mode tariffs.

You can also configure input mode tariffs using ION Setup.

You cannot configure any digital input tariff if digital input 1 is not available for association. Likewise, digital input 2 must be available to select more than two tariffs.

The status of the digital inputs is used to calculate the binary value of the active tariff, where off = 0 and on = 1. The calculation of the number of tariffs value can differ, depending on the number of digital inputs that can be selected (i.e., inputs that can be associated with multi-tariff).

1. Navigate to **Maint > Setup**.
2. Enter the setup password (default is “0”), then press **OK**.
3. Navigate to **Meter > Tariff**.
4. Select **Mode** and press **Edit**.
5. Press **+** or **-** to change the setting to **Input**, then press **OK**.

NOTE: If a digital input association error prompt displays, you must exit from the tariff setup screens and remove the digital input association.

6. Navigate to **Tariffs**, then press **Edit**.
7. Press **+** or **-** to change the number of tariffs you want to set up and press **OK**.

The maximum number of tariffs that you can apply is determined by the number of available digital inputs.

8. Navigate to **Inputs**, then press **Edit**.

If applicable, press **+** or **-** to change how many digital inputs you want to use to control which tariff is selected (active). Press **OK**.

9. Press the up arrow to exit, then **Yes** to save your changes.

Measurements

Instantaneous measurements

The meter provides highly accurate 1-second measurements.

These measurements include true RMS, per phase and total for:

- 3-phase voltage (line-to-line, line-to-neutral)
- 3-phase current, neutral and ground current
- Active (kW), reactive (kVAR) and apparent (kVA) power
- True PF (power factor)
- Displacement PF
- System frequency
- Voltage (line-to-line, line-to-neutral) and current unbalance

The voltage and current inputs are continuously monitored at a sampling rate of 128 points per cycle. This amount of resolution helps enable the meter to provide reliable measurements and calculated electrical values for various commercial, buildings and industrial applications.

Energy measurements

The meter provides fully bi-directional, 4-quadrant, Class 0.2S accurate energy metering.

The meter stores all accumulated active, reactive and apparent energy measurements in nonvolatile memory:

- kWh, kVARh, kVAh (delivered and received)
- kWh, kVARh, kVAh net (delivered - received)
- kWh, kVARh, kVAh absolute (delivered + received)

Energy registers can be logged automatically on a programmed schedule. All energy parameters represent the total for all three phases.

Min/max values

When the readings reach their lowest or highest value, the meter updates and saves these min/max (minimum and maximum) quantities with date and time of occurrence in non-volatile memory.

The meter's real-time readings are updated once every 50 cycles for 50 Hz systems, or once every 60 cycles for 60 Hz systems.

Demand measurements

The meter provides present, last, predicted and peak (maximum) demand, and a date/timestamp when the peak demand occurred.

The meter supports standard demand calculation methods, including sliding block, fixed block, rolling block, thermal and synchronized.

Peak demand registers can be reset manually (password protected) or logged and reset automatically on a programmed schedule.

Demand measurements include:

- kW, kVAR, kVA demand total and per phase
- Amps demand average, per phase and neutral (4th CT)

- Demand calculation for pulse input metering (WAGES)

Power demand

Power demand is a measure of average power consumption over a fixed time interval.

NOTE: If not specified, references to “demand” are assumed to mean “power demand.”

The meter measures instantaneous consumption and can calculate demand using various methods.

Related Topics

- Meter resets

Power demand calculation methods

Power demand is calculated by dividing the energy accumulated during a specified period by the length of that period.

How the meter performs this calculation depends on the method and time parameters you select (for example, timed rolling block demand with a 15-minute interval and 5-minute subinterval).

To be compatible with electric utility billing practices, the meter provides the following types of power demand calculations:

- Block interval demand
- Synchronized demand
- Thermal demand

You can configure the power demand calculation method from the display or software.

Block interval demand

For block interval demand method types, you specify a period of time interval (or block) that the meter uses for the demand calculation.

Select/configure how the meter handles that interval from one of these different methods:

Type	Description
Timed Sliding Block	Select an interval from 1 to 60 minutes (in 1-minute increments). If the interval is between 1 and 15 minutes, the demand calculation <i>updates every 15 seconds</i> . If the interval is between 16 and 60 minutes, the demand calculation <i>updates every 60 seconds</i> . The meter displays the demand value for the last completed interval.
Timed Block	Select an interval from 1 to 60 minutes (in 1-minute increments). The meter calculates and updates the demand at the end of each interval.
Timed Rolling Block	Select an interval and a subinterval. The subinterval must divide evenly into the interval (for example, three 5-minute subintervals for a 15-minute interval). Demand is <i>updated at the end of each subinterval</i> . The meter displays the demand value for the last completed interval.

Block interval demand example

The following illustration shows the different ways power demand is calculated using the block interval method. In this example, the interval is set to 15 minutes.

Timed Sliding Block

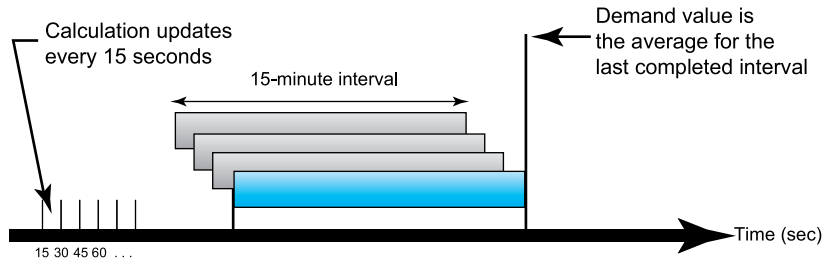

Timed Block

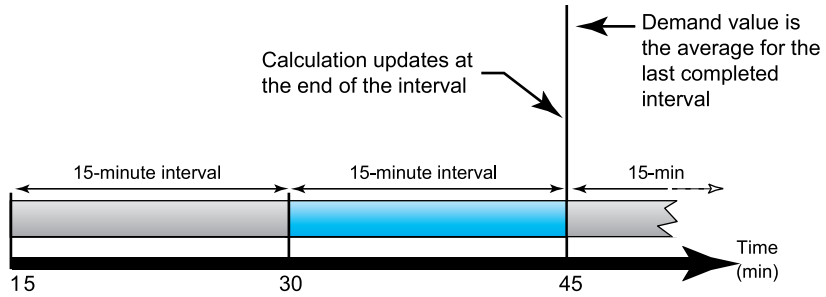

Timed Rolling Block

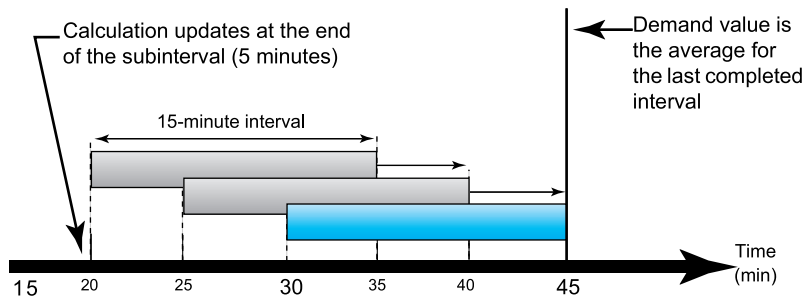

Synchronized demand

You can configure the demand calculations to be synchronized using an external pulse input, a command sent over communications, or the device’s internal real-time clock.

Type	Description
Input synchronized demand	This method allows you to synchronize the demand interval of your meter with an external digital pulse source (such as another meter’s digital output) connected to your meter’s digital input. This helps synchronize your meter to the same time interval as the other meter for each demand calculation.
Command synchronized demand	This method allows you to synchronize the demand intervals of multiple meters on a communications network. For example, if a programmable logic controller (PLC) input is monitoring a pulse at the end of a demand interval on a utility revenue meter, you can program the PLC to issue a command to multiple meters whenever the utility meter starts a new demand interval. Each time the command is issued, the demand readings of each meter are calculated for the same interval.
Clock synchronized demand	This method allows you to synchronize the demand interval to the meter’s internal real-time clock. This helps you synchronize the demand to a particular time, typically on the hour (for example, at 12:00 am). If you select another time of day when the demand intervals are to be synchronized, the time must be specified in minutes from midnight. For example, to synchronize at 8:00 am, select 480 minutes.

NOTE: For these demand types, you can choose block or rolling block options. If you select a rolling block demand option, you need to specify a subinterval.

Thermal demand

Thermal demand calculates the demand based on a thermal response, which imitates the function of thermal demand meters.

The demand calculation updates at the end of each interval. You can set the demand interval from 1 to 60 minutes (in 1-minute increments).

Thermal demand example

The following illustration shows the thermal demand calculation. In this example, the interval is set to 15 minutes. The interval is a window of time that moves across the timeline. The calculation updates at the end of each interval.

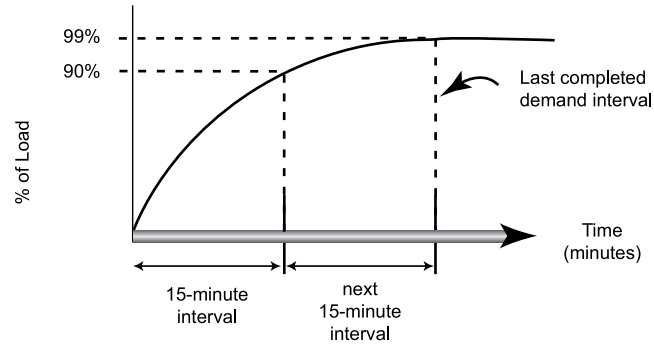

Current demand

The meter calculates current demand using the block interval, synchronized or thermal demand methods.

You can set the demand interval from 1 to 60 minutes in 1 minute increments (for example, 15 minutes).

Related Topics

- Meter resets

Predicted demand

The meter calculates predicted demand for the end of the present interval for kW, kVAR, and kVA demand, taking into account the energy consumption so far within the present (partial) interval and the present rate of consumption.

Predicated demand is updated according to the update rate of your meter.

The following illustration shows how a change in load can affect predicted demand for the interval. In this example, the interval is set to 15 minutes.

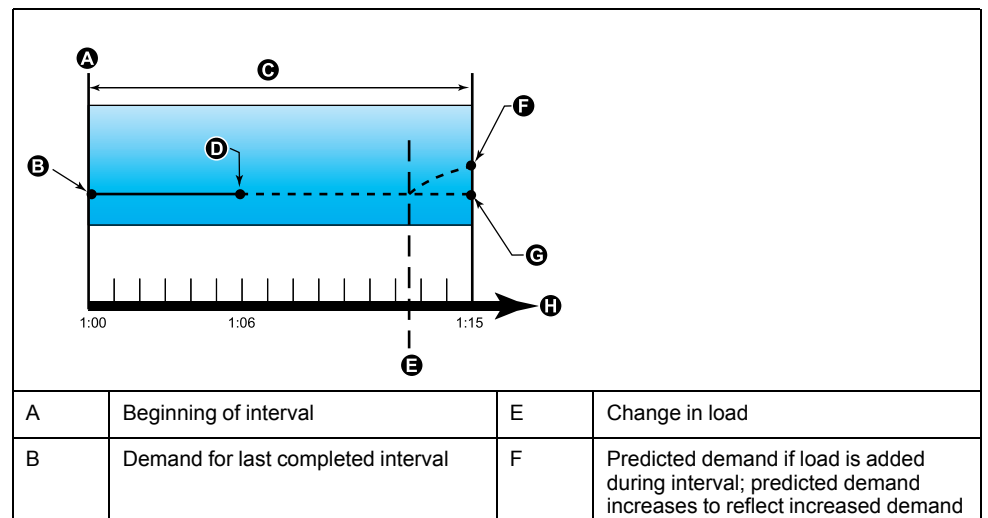

C	15-minute interval	G	Predicted demand if no load is added
D	Partial interval	H	Time

Peak demand

The meter records the peak (or maximum) values for kWd, kVARD, and kVAD power (or peak demand).

The peak for each value is the highest average reading since the meter was last reset. These values are maintained in the meter’s non-volatile memory.

The meter also stores the date and time when the peak demand occurred. In addition to the peak demand, the meter also stores the coinciding average 3-phase power factor. The average 3-phase power factor is defined as “demand kW/ demand kVA” for the peak demand interval.

Input Metering Demand

The input metering channels can be used to measure water, air, gas, electric and steam utilities (WAGES).

The number of available metering input channels equals the number of unused digital inputs.

Typical WAGES utility meters have no communications capabilities, but they usually have a pulse output. The utility meter sends a pulse to its output each time a preset quantity or amount of (WAGES) energy is consumed or delivered. This preset quantity or amount is referred to as the pulse weight.

To monitor the utility meter, connect its pulse output to the power meter’s digital input. Associate the digital input for input metering and configure the input metering operation mode, pulse weight, consumption units and demand units.

Related Topics

- Input metering

Setting up demand calculations

Use the Demand setup screens to define power demand, current demand or input metering demand.

Demand is a measure of average consumption over a fixed time interval.

1. Navigate to **Maint > Setup**.
2. Enter the setup password (default is “0”), then press **OK**.
3. Navigate to **Meter > Dmd**.
4. Move the cursor to select **Power Demand, Current Demand or Input Demand**.
5. Move the cursor to point to the parameter you want to modify, then press **Edit**.

Values	Description
Method	
Timed Sliding Block Timed Block Timed Rolling Block Input Sync Block Input Sync Roll Block Cmd Sync Block Cmd Sync Roll Block Clock Sync Block	Select the appropriate demand calculation method for your needs

Values	Description
Clock Sync Roll Block Thermal	
Interval	
1–60	Set the demand interval, in minutes.
Subinterval	
1–60	Applies only to rolling block methods. Define how many subintervals the demand interval should be equally divided into.
Select Dig Output	
None Digital Output D1 Digital Output D2	Select which digital output the end of demand interval pulse should be sent to.
Select Dig Input	
None Digital Input S1 Digital Input S2 Digital Input S3 Digital Input S4	Applies only to input sync methods. Select which digital input is used to sync the demand.
Clock Sync Time	
0 - 2359	Applies only to clock sync methods (these synchronize the demand interval to the meter's internal clock). Define what time of day you want to synchronize the demand, from the start of the day. For example, set this setting to 0730 to synchronize demand at 7:30 AM.

6. Modify the parameter as required, then press **OK**.
7. Move the cursor to point to the next parameter you want to modify, press **Edit**, make your changes, then press **OK**.
8. Press **Yes** to save your changes.

Power and power factor

The sampled measurements taken at the meter's voltage and current inputs provide data for calculating power and power factor.

In a balanced 3-phase alternating current (AC) power system source, the AC voltage waveforms on the current-carrying conductors are equal but offset by one-third of a period (a phase angle shift of 120 degrees between the three voltage waveforms).

Current phase shift from voltage

Electrical current can lag, lead, or be in phase with the AC voltage waveform, and is typically associated with the type of load — inductive, capacitive or resistive.

For purely resistive loads, the current waveform is in phase with the voltage waveform. For capacitive loads, current leads voltage. For inductive loads, current lags voltage.

The following diagrams show how voltage and current waveforms shift based on load type under ideal (laboratory) conditions.

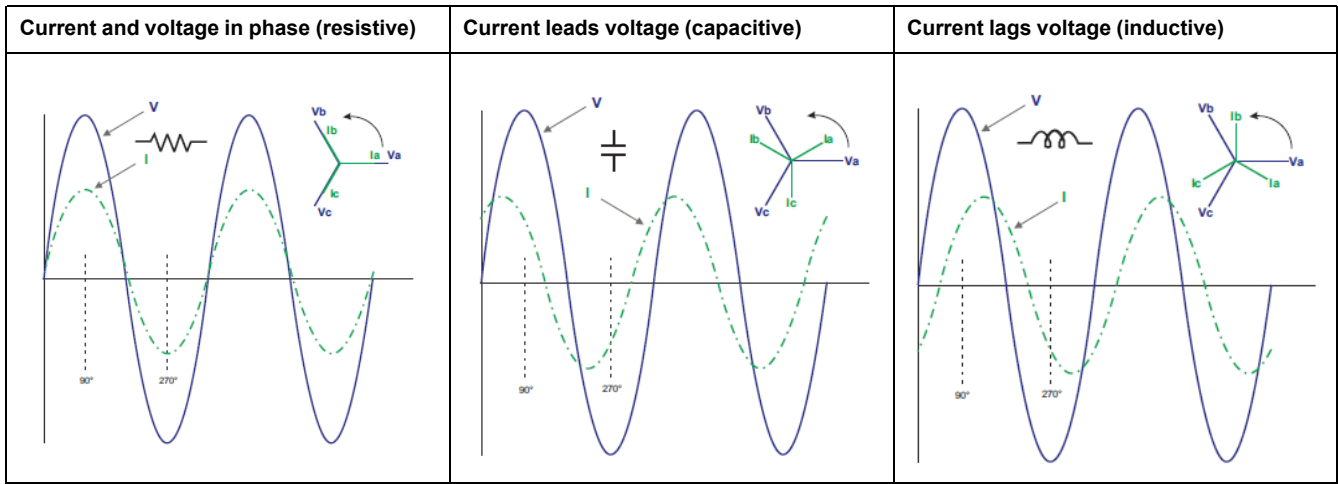

Real, reactive and apparent power (PQS)

A typical AC electrical system load has both resistive and reactive (inductive or capacitive) components.

Real power, also known as active power (P) is consumed by resistive loads. Reactive power (Q) is either consumed by inductive loads or generated by capacitive loads.

Apparent power (S) is the capacity of your measured power system to provide real and reactive power.

The units for power are watts (W or kW) for real power P, vars (VAR or kVAR) for reactive power Q, and volt-amps (VA or kVA) for apparent power S.

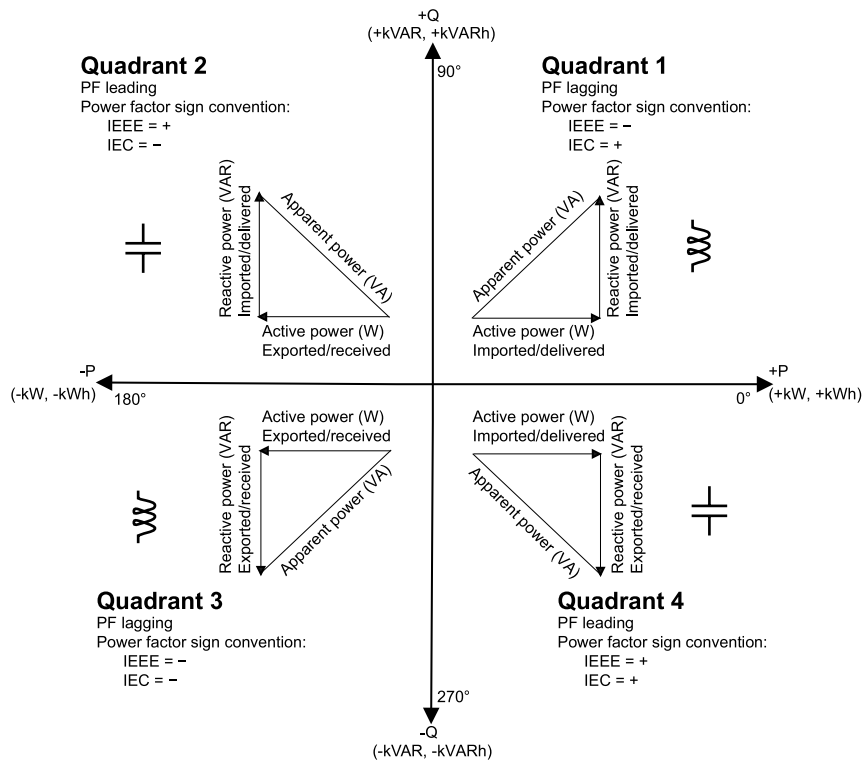

Power flow

Positive real power P(+) flows from the power source to the load. Negative real power P(-) flows from the load to the power source.

Power factor (PF)

Power factor (PF) is the ratio of real power (P) to apparent power (S).

Power factor is provided as a number between -1 and 1 or as a percentage from -100% to 100%, where the sign is determined by the convention.

$$PF = \frac{P}{S}$$

An ideal, purely resistive load has no reactive components, so its power factor is one (PF = 1, or unity power factor). Inductive or capacitive loads introduce a reactive power (Q) component to the circuit which causes the PF to become closer to zero.

True PF and displacement PF

The meter supports true power factor and displacement power factor values:

- True power factor includes harmonic content.
- Displacement power factor only considers the fundamental frequency.

NOTE: Unless specified, the power factor displayed by the meter is true power factor.

Power factor sign convention

Power factor sign (PF sign) can be positive or negative, and is defined by the conventions used by the IEEE or IEC standards.

You can set the power factor sign (PF sign) convention that is used on the display to either IEC or IEEE.

PF sign convention: IEC

PF sign correlates with the direction of real power (kW) flow.

- Quadrant 1 and 4: Positive real power (+kW), the PF sign is positive (+).
- Quadrant 2 and 3: Negative real power (-kW), the PF sign is negative (-).

PF sign convention: IEEE

PF sign is correlates with the PF lead/lag convention, in other words, the effective load type (inductive or capacitive):

- For a capacitive load (PF leading, quadrant 2 and 4), the PF sign is positive (+).
- For an inductive load (PF lagging, quadrant 1 and 3), the PF sign is negative (-).

Related Topics

- Setting up regional settings

Power factor register format

The meter provides power factor values in a variety of formats to suit your energy management software.

Power factor in IEC and lead/lag (IEEE) formats: Float32 and Int16U registers

The meter provides total power factor in IEC and lead/lag (IEEE) formats in both Float32 and Int16U data types. You can use these registers to bring power factor information into third-party software. These registers are interpreted using the standard IEC and IEEE sign conventions.

NOTE: For information on how to calculate actual power factor values from the values in Int16U registers, see your meter's Modbus register list, available from www.schneider-electric.com.

Four quadrant power factor information: floating point registers

The meter also provides PF information (including sign and quadrant) in single floating point registers for each of the PF values (for example, per-phase and total values for true and displacement PF, and associated minimums and maximums). The meter performs a simple algorithm to the PF value then stores it in the appropriate PF register.

The meter and software (such as Power Monitoring Expert or ION Setup) interpret these PF registers for reporting or data entry fields according to the following diagram:

Quadrant	PF range	PF register range	PF formula
Quadrant 3	0 to -1	-2 to -1	PF value = (-2) - (PF register value)
Quadrant 4	+1 to 0	+1 to +2	PF value = (+2) - (PF register value)

Go to www.schneider-electric.com and search for your meter's Modbus register list to download a copy.

Timers

The meter supports an I/O timer, active load timer and an operating timer.

Use the meter display to navigate to the Timer and I/O screens to view timer information.

Operating Timer

The operating timer (**Timer > Oper**) keeps track of how long the meter has been powered up.

Load Timer

The load timer keeps track of how much time the input current exceeds the specified load timer setpoint current.

I/O timer

The I/O timer shows how long an input or output has been ON.

Related Topics

- Configuring advanced setup parameters using the display

Power quality

Power quality measurements

The meter provides complete harmonic distortion metering, recording and real-time reporting, up to the 63rd harmonic for all voltage and current inputs.

The following power quality measurements are available:

- Individual harmonics (odd harmonics up to 63rd)
- Total harmonic distortion (THD, thd) for current and voltage (line-to-line, line-to-neutral)
- Total demand distortion (TDD)
- K-factor, Crest factor
- Neutral current metering and ground current calculation

The following harmonics data is available on the display:

- Numeric magnitude and angle of the fundamental (first) harmonic.
- Graphical display of the 3rd to 31st harmonics, expressed as a percentage of the fundamental harmonic.

Harmonics overview

Harmonics information is valuable for power quality analysis, determining properly rated transformers, maintenance and troubleshooting.

Harmonics are integer multiples of the fundamental frequency of the power system. Harmonics information is required for compliance to system power quality standards such as EN50160 and meter power quality standards such as IEC 61000-4-30.

Harmonics measurements include per-phase magnitudes and angles (relative to the fundamental frequency of the phase A voltage) for the fundamental and higher harmonics relative to the fundamental frequency. The meter's power system setting defines which phases are present and determines how line-to-line or line-to-neutral voltage harmonics and current harmonics are calculated.

Harmonics are used to identify whether the supplied system power meets required power quality standards, or if non-linear loads are affecting your power system. Power system harmonics can cause current flow on the neutral conductor, and damage to equipment such as increased heating in electric motors. Power conditioners or harmonic filters can be used to minimize unwanted harmonics.

Voltage crest factor

Crest factor is the ratio of peak to RMS voltage values.

For a pure sinusoidal waveform, crest factor is equal to 1.414. The meter uses the following equation to calculate crest factor:

$C = \frac{V_{\text{peak}}}{V_{\text{RMS}}}$	C = Crest factor
	V_{peak} = Voltage peak
	V_{RMS} = Voltage RMS

K-factor

K-factor relates the heating effect of a distorted current in a transformer to a sinusoidal current with the same RMS magnitude — it describes a transformer’s ability to serve non-linear loads without exceeding rated temperature rise limits.

The K-factor is equal to the sum of the squares of the harmonic currents multiplied by the squares of the harmonic order. The meter uses the following equation to calculate K-factor:

$$K = \frac{\sum_{n=1}^h (I_n^2 \times h^2)}{\sum_{n=1}^h I_n^2}$$

Where K is the K-factor, h is the harmonic order and I_h is the true RMS current of harmonic order h .

Total harmonic distortion

Total harmonic distortion (THD) is a measure of the total per-phase voltage or current harmonic distortion present in the power system.

THD provides a general indication of the quality of a waveform. THD% is calculated for each phase of both voltage and current.

Total demand distortion

Total demand distortion (TDD) is the per-phase harmonic current distortion against the full load demand of the electrical system.

TDD indicates the impact of harmonic distortion in the system. For example, if your system is showing high THD values but a low demand, the impact of harmonic distortion on your system might be insignificant. However at full load, the THD value for the current harmonics is equal to TDD, so this could negatively impact your system.

Harmonic content calculations

Harmonic content (H_C) is equal to the RMS value of all the non-fundamental harmonic components in one phase of the power system.

The meter uses the following equation to calculate H_C :

$$H_C = \sqrt{(H_2)^2 + (H_3)^2 + (H_4)^2 \dots}$$

THD% calculations

THD% is a quick measure of the total distortion present in a waveform and is the ratio of harmonic content (H_C) to the fundamental harmonic (H_1).

The meter uses the following equation to calculate THD%:

$$THD = \frac{H_C}{H_1} \times 100$$

thd calculations

thd is an alternate method for calculating total harmonic distortion that uses the RMS value for the total harmonic content rather than the fundamental content.

The meter uses the following equation to calculate thd:

$$\text{thd} = \frac{\text{HC}}{\sqrt{(\text{H1})^2 + (\text{HC})^2}} \times 100$$

TDD calculations

TDD (total demand distortion) evaluates the harmonic currents between an end user and a power source.

The harmonic values are based on a point of common coupling (PCC), which is a common point where each user receives power from the power source.

The meter uses the following equation to calculate TDD:

$$\text{TDD} = \left(\sqrt{(\text{HCIA})^2 + (\text{HCIB})^2 + (\text{HCIC})^2} \right) / (\text{ILoad}) \times 100$$

Where I_{Load} is equal to the maximum demand load on the power system.

Viewing harmonics using the display

You can view harmonics data using the display.

1. Navigate to **Harm**.
The **Harmonics %** screen displays:
2. Press the voltage or current harmonics you want to view.

IEEE mode	IEC mode	Description
V L-L	U	Line-to-line voltage harmonics data
V L-N	V	Line-to-neutral voltage harmonics data
Amps	I	Current harmonics data
TDD/K	TDD/K	Total demand distortion and K-factor data
Crest	Crest	Crest factor data

The fundamental (1st) harmonics numeric magnitudes and angles for all phases are displayed.

- Press **3-11**, **13-21**, or **21-31** to view the graphs for the 3rd to the 11th, 13th to 21st, or 23rd to 31st harmonics, respectively.

For example, to display the 13th to 21st harmonics screen, press **13-21**.

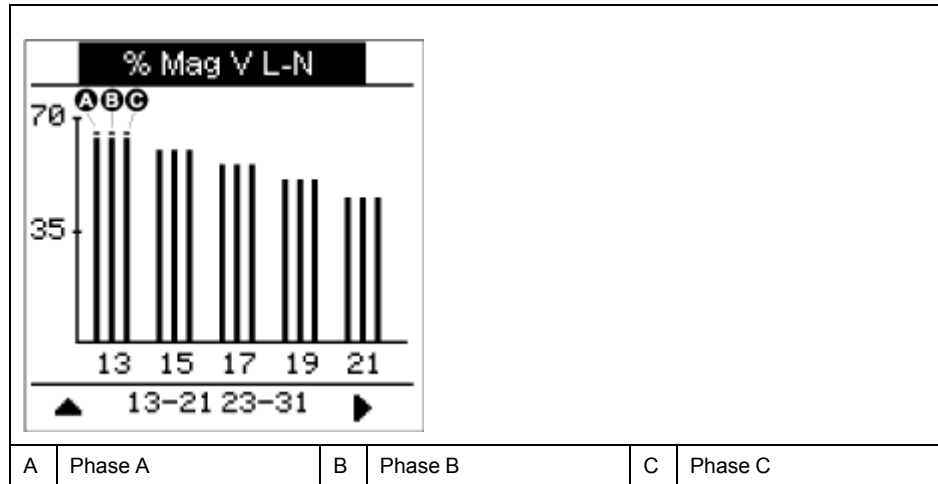

The vertical axis of the harmonics graph indicates the harmonic’s magnitude as a percentage of the fundamental harmonic, and is scaled based on the largest harmonic displayed. At the top of each vertical bar is a marker that shows the maximum value of the harmonic. If the harmonic is greater than the fundamental harmonic, this marker is triangular-shaped to show that the value is out of range.

NOTE: The display screen only shows odd harmonics up to the 31st harmonic. However, all individual odd and even harmonics data up to the 63rd harmonic is available through communications and software. Individual harmonics data include current harmonics per phase, neutral and ground, and voltage harmonics line-to-line, line-to-neutral and neutral to ground.

Viewing TDD, K-factor and Crest factor data

The meter display provides screens that show TDD, K-factor and Crest factor values.

NOTE: Your meter’s Modbus map includes registers for harmonics data for integration into your power or energy management system.

- Navigate to **Harm > TDD/K**.

The TDD and K-factor per phase information displays.

Value	Description
TDD	Total demand distortion
K-F A	K factor for phase A
K-F B	K factor for phase B
K-F C	K factor for phase C

- Navigate to **Harm > Crest**.

The Crest factor information displays.

IEEE mode	IEC mode	Description
V L-L	U	Crest factor data for line-to-line voltage
V L-N	V	Crest factor data for line-to-neutral voltage
Amps	I	Crest factor data for current

3. Press the up arrow to return to the main display screens.

Viewing THD/thd using the display

You can view THD/thd data using the display.

NOTE: Your meter's Modbus map includes registers for total harmonic distortion data for integration into your power or energy management system.

1. Navigate to **THD** to view the **THD/thd Select** screen.
2. Press **THD** to display values that use the calculation method based on the fundamental harmonic or **thd** to display values that use the calculation method based on the RMS value of all harmonics in that phase (including the fundamental).

IEEE mode	IEC mode	Description
Amps	I	Total harmonic distortion data for per phase and neutral currents.
V L-L	U	Total harmonic distortion data line-to-line voltage.
V L-N	V	Total harmonic distortion data line-to-neutral voltage.

3. Press the current or voltage THD or thd values you want to view.
The total harmonic distortion percentage values are displayed.
4. Press the up arrow to return to the main display screens.

Maintenance

Maintenance overview

The meter does not contain any user-serviceable parts. If the meter requires service, contact your local Schneider Electric Technical Support representative.

NOTICE

METER DAMAGE

- Do not open the meter case.
- Do not attempt to repair any components of the meter.

Failure to follow these instructions can result in equipment damage.

Do not open the meter. Opening the meter voids the warranty.

Lost user access

If you lose your meter's user access (password) information, contact your local Schneider Electric representative for instructions on how to return your meter for factory reconfiguration.

NOTE: Have your meter's serial number available for reference.

Diagnostics information

The meter provides you with diagnostics information to help with troubleshooting.

The display provides

- the Info (information), Meter and CL Pwr (loss of control power) diagnostics screens.
- the Phasor and Polar screens to help troubleshoot incorrect wiring.

You can access the meter's maintenance log using the webpages.

Related Topics

- Data display screens
- Default webpages

Wrench icon

The wrench icon appears on the top corner of the display screen.

The wrench icon  alerts you when there is an overvoltage condition or a potential hardware or firmware problem in the meter that requires attention. It could also indicate that the energy pulsing LED is in an overrun state.

Navigate to **Maint > Diag > Meter** to view details of the meter status. Make note of the information shown on the screen, then contact Technical Support.

Troubleshooting LED indicators

Abnormal heartbeat / serial communications LED behavior could mean potential problems with the meter.

Problem	Probable causes	Possible solutions
LED flash rate does not change when data is sent from the host computer.	Communications wiring	If using a serial-to-RS-485 converter, trace and check that all wiring from the computer to the meter is properly terminated.
	Internal hardware problem	Perform a hard reset: turn off control power to the meter, then re-apply power. If the problem persists, contact Technical Support.
Heartbeat / serial communications LED remains lit and does not flash ON and OFF	Internal hardware problem	Perform a hard reset: turn off control power to the meter, then re-apply power. If the problem persists, contact Technical Support.
Heartbeat / serial communications LED flashes, but the display is blank.	Display setup parameters incorrectly set	Review display parameter setup.

If the problem is not fixed after troubleshooting, contact Technical Support for help. Make sure you have your meter’s firmware version, model and serial number information available.

Related Topics

- Heartbeat / serial communications LED
- Setting up the display

Phasors

Phasors are used to represent the voltage and current relative magnitude and angles.

The length of the lines in the phasor diagram represent the relative magnitude of the voltages with respect to the other phase voltages, and the currents with respect to the other phase currents. All angles are measured with respect to the Va/V1 phase. The Va/V1 phasor is fixed to the right-hand horizontal axis (positive x-axis). Positive angles are measured counterclockwise.

Numeric values are provided for the magnitude and relative angle for each voltage and current phase.

Phasor information can be used to troubleshoot incorrect connections on the meter’s voltage and current inputs (for example, switched phase wiring or polarity errors), if you know how the phasors should be oriented for your power system.

Phasor screens

Phasor information is available on the meter’s display.

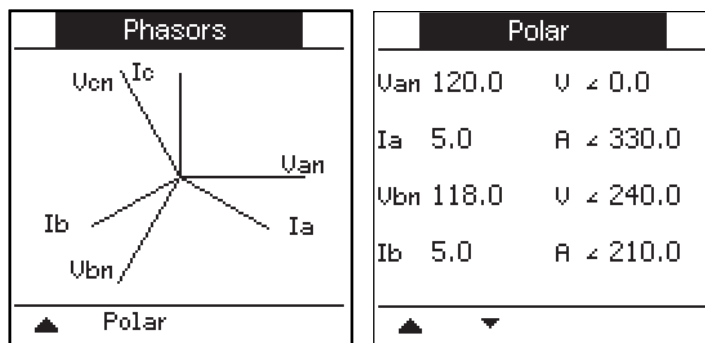

The graph on the Phasors screen shows a representation of the phase angles in degrees. The Polar screen shows the RMS value and phase angle of each voltage and current phases.

NOTE: If two phasor lines overlap (i.e. if they have the same relative phase angle), only one phase label is visible as phasor diagram labels are overwritten dynamically on the display panel.

Meter memory

The meter stores configuration and logging information in non-volatile memory and a long-life memory chip.

The meter uses its non-volatile memory (NVRAM) to retain all data and metering configuration values. Under the operating temperature range specified for the meter, the NVRAM has an anticipated life of 45 years or longer. The meter stores its data logs in a memory chip, which has a life expectancy of up to 20 years under the operating temperature range specified for the meter.

Meter battery

The internal battery in the meter keeps its clock running and helps maintain the time even when the meter is powered down.

The life expectancy of the meter's internal battery is estimated to be over 3 years at 25 °C under typical operating conditions.

Firmware version, model and serial number

You can view the meter's firmware version (including OS, RS and Ethernet versions), model and serial number from the display panel or through the meter webpages.

- Using the display panel: Navigate to **Maint > Diag > Info**.
- Using the meter webpages: Navigate to **Diagnostics > Meter Information**.

NOTE: For MID compliance, the meter's firmware upgrade functionality is permanently disabled. You cannot upgrade a PM5561 meter's firmware. The OS CRC value is a number that identifies the uniqueness between different OS firmware versions.

Firmware upgrades

There are a number of reasons why you may want to upgrade your meter's firmware.

- Improve meter performance (e.g., optimize processing speed)
- Enhance existing meter features and functions
- Add new functionality to the meter
- Achieve compliance to new industry standards

Meter upgrade requirements

There are some requirements to consider before you upgrade your meter's firmware.

In order to upgrade the meter, you need to:

- Be connected to the meter using Ethernet.

NOTE: It is recommended that you change the IP Address Acquisition Mode to Stored during the firmware upgrade. If the mode is set to DHCP, the IP address might change during the upgrade, which will result in a loss of communications with the meter.

- Make sure the meter's FTP server is enabled.
- Have Product Master credentials to log in to the meter's FTP server. The FTP server uses the same user accounts as the meter's webpages.
- Download the latest upgrade files from www.schneider-electric.com. The upgrade files include:
 - App2.out: this file contains the files needed to upgrade the code and initialization files that run the Ethernet communications.
 - PM556x_vX.Y.Z.fwa (where X.Y.Z is the specific firmware version): this file contains all the files needed to upgrade other meter components, such as the meter's operating system, language files and webpages.
 - PM5500StartUpgrade.shtml

Save these files to a location you can access from the computer you use to perform the upgrade.

NOTE: After you use the FTP meter upgrade process, you can no longer use DLF3000 software to upgrade the meter.

Related Topics

- User groups
- Enabling and disabling the FTP server using the webpages

Upgrading your meter

You can upgrade the meter's firmware, language files, webpages and Ethernet communications card using the meter's internal FTP server.

Your meter, Ethernet card and accessories do not operate normally during firmware upgrade, and your meter's digital outputs may change state during a firmware upgrade.

⚠ WARNING

UNINTENDED OPERATION OR METER DAMAGE

- Do not use this device for critical control or protection applications where human or equipment safety relies on the operation of the control circuit.
- Do not turn off power to the meter while the firmware upgrade is in progress.

Failure to follow these instructions can result in death, serious injury, or equipment damage.

This example walks through upgrading your meter using Windows Explorer to access the meter's FTP server. You can also use other FTP clients, such as FileZilla.

1. Open Windows Explorer and connect to your meter by entering `ftp:\\<meter IP address>` replacing `<meter IP address>` with the IP address of the meter you want to upgrade.
2. Enter a Product Master username and password when prompted.
The FTP server appears, containing the folders `fw` and `www`.
3. Open another instance of Windows Explorer and navigate to the location where you saved the firmware upgrade files.
4. Copy the `PM5500StartUpgrade.shtml` file and paste it into the `www` folder on the meter's FTP server.

5. Copy the App2.out and PM556x_vX.Y.Z.fwa files and paste them into the fw folder on the meter's FTP server.

NOTE: If a file with the same name already exists on the meter, you are prompted to confirm whether or not you want to replace that file. Click **Yes** (to replace that one file) or **Yes to All** (to replace all files).

NOTE: If you have added a large number of custom files (such as webpages) to the meter's FTP server, there may not be enough memory on the meter's Ethernet communications card to paste the files, and you may receive an error when you try to paste the files. You may need to temporarily move some of these custom files before proceeding.

6. Exit Windows Explorer after the file copying is complete.
7. Open your browser and enter `http://<meter IP address>/PM5500StartUpgrade.shtml` to trigger the upgrade, where `<meter IP address>` is replaced with your meter's IP address.

Enter your login credentials when prompted.

NOTE: Accessing this webpage restarts the meter's Ethernet communications card, which initiates the upgrade process. It might take a minute or two while the meter's Ethernet communications card is reset and the upgrade initialized.

From the PM5500StartUpgrade.shtml page, you are redirected to a firmware upgrade status page where you can view information about the upgrade process.

NOTE: If the status page indicates that one of the upgrade processes failed, restart the upgrade process from the beginning by reconnecting to the meter's FTP server, recopying the files then following the rest of the procedure.

Technical assistance

Visit www.schneider-electric.com for support and assistance with lost passwords or other technical problems with the meter.

Make sure you include your meter's model, serial number and firmware version in your email or have it readily available if calling Technical Support.

Verifying accuracy

Overview of meter accuracy

All meters are tested and verified at the factory in accordance with International Electrotechnical Commission (IEC) and American National Standards Institute (ANSI) standards.

Your digital power meter typically does not require re-calibration. However, in some installations a final accuracy verification of the meters is required, especially if the meters will be used for revenue or billing applications.

Accuracy test requirements

The most common method for testing meter accuracy is to apply test voltages and currents from a stable power source and compare the meter's readings with readings from a reference device or energy standard.

Signal and power source

The meter maintains its accuracy during voltage and current signal source variations but its energy pulsing output needs a stable test signal to help produce accurate test pulses. The meter's energy pulsing mechanism needs approximately 10 seconds to stabilize after every source adjustment.

The meter must be connected to control power in order to conduct accuracy verification testing. Refer to your meter's installation documentation for power supply specifications.

⚠ DANGER

HAZARD OF ELECTRIC SHOCK, EXPLOSION, OR ARC FLASH

Verify the device's power source meets the specifications for your device's power supply.

Failure to follow these instructions will result in death or serious injury.

Control equipment

Control equipment is required for counting and timing the pulse outputs from an energy pulsing LED or digital output.

- Most standard test benches have an arm equipped with optical sensors to detect LED pulses (the photodiode circuitry converts detected light into a voltage signal).
- The reference device or energy standard typically has digital inputs that can detect and count pulses coming from an external source (i.e., the meter's digital output).

NOTE: The optical sensors on the test bench can be disrupted by strong sources of ambient light (such as camera flashes, florescent tubes, sunlight reflections, floodlights, etc.). This can cause test errors. Use a hood, if necessary, to block out ambient light.

Environment

The meter should be tested at the same temperature as the testing equipment. The ideal temperature is about 23 °C (73 °F). Make sure the meter is warmed up sufficiently before testing.

A warm-up time of 30 minutes is recommended before beginning energy accuracy verification testing. At the factory, the meters are warmed up to their typical operating temperature before calibration to help ensure that the meters will reach their optimal accuracy at operating temperature.

Most high precision electronic equipment requires a warm up time before it reaches its specified performance levels. Energy meter standards allow the manufacturers to specify meter accuracy derating due to ambient temperature changes and self-heating.

Your meter complies with and meets the requirements of these energy metering standards.

For a list of accuracy standards that your meter complies to, contact your local Schneider Electric representative or download the meter brochure from www.schneider-electric.com.

Reference device or energy standard

To help ensure the accuracy of the test, it is recommended that you use a reference device or reference energy standard with a specified accuracy that is 6 to 10 times more accurate than the meter under test. Before you start testing, the reference device or energy standard should be warmed up as recommended by its manufacturer.

NOTE: Verify the accuracy and precision of all measurement equipment used in accuracy testing (for example, voltmeters, ammeters, power factor meters).

Meter settings for accuracy testing

Your meter's power system and other parameters must be configured for accuracy testing.

Meter parameter	Value
Power system	3PH4W Wye Gnd (3-phase, 4 wire Wye with ground)
Energy pulse constant (alarm/energy pulsing LED or digital output)	In sync with reference test equipment

Related Topics

- Device specifications

Verifying accuracy test

The following tests are guidelines for accuracy testing your meter; your meter shop may have specific testing methods.

⚠ DANGER

HAZARD OF ELECTRIC SHOCK, EXPLOSION, OR ARC FLASH

- Apply appropriate personal protective equipment (PPE) and follow safe electrical work practices. See NFPA 70E in the USA, CSA Z462 or applicable local standards.
- Turn off all power supplying this device and the equipment in which it is installed before working on the device or equipment.
- Always use a properly rated voltage sensing device to confirm that all power is off.
- Do not exceed the device's ratings for maximum limits.
- Verify the device's power source meets the specifications for your device's power supply.

Failure to follow these instructions will result in death or serious injury.

1. Turn off all power supplying this device and the equipment in which it is installed before working on the device or equipment.
2. Use a properly rated voltage sensing device to confirm that all power is off.
3. Connect the test voltage and current source to the reference device or energy standard. Ensure all voltage inputs to the meter under test are connected in parallel and all current inputs are connected in series.

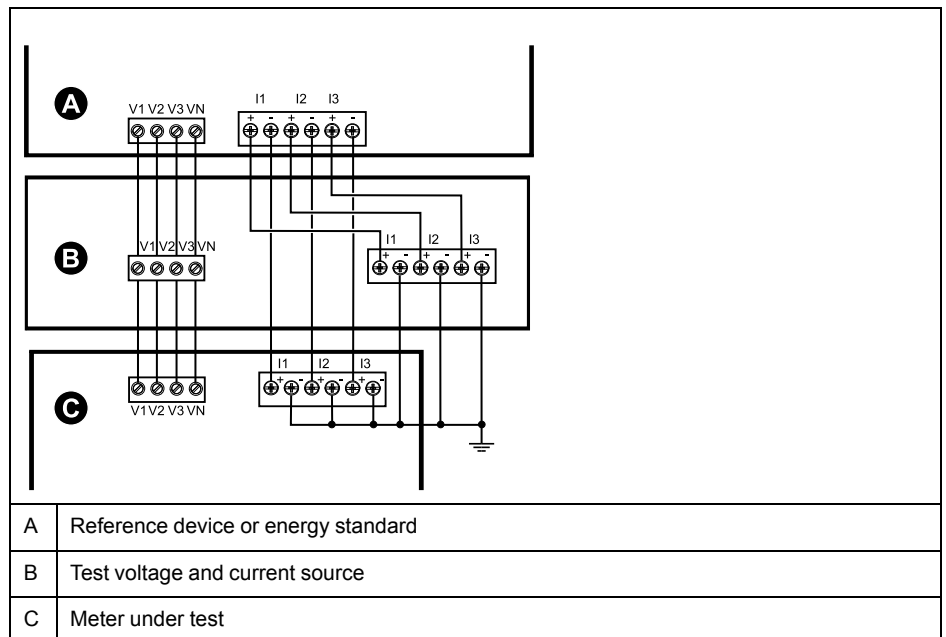

4. Connect the control equipment used for counting the standard output pulses using one of these methods:

Option	Description
Energy pulsing LED	Align the red light sensor on the standard test bench armature over the energy pulsing LED.
Digital output	Connect the meter's digital output to the standard test bench pulse counting connections.

NOTE: When selecting which method to use, be aware that energy pulsing LEDs and digital outputs have different pulse rate limits.

5. Before performing the verification test, let the test equipment power up the meter and apply voltage for at least 30 seconds. This helps stabilize the internal circuitry of the meter.
6. Configure the meter's parameters for verifying accuracy testing.

7. Depending on the method selected for counting the energy pulses, configure the meter's energy pulsing LED or one of the digital outputs to perform energy pulsing. Set the meter's energy pulse constant so it is in sync with the reference test equipment.
8. Perform accuracy verification on the test points. Run each test point for at least 30 seconds to allow the test bench equipment to read an adequate number of pulses. Allow 10 seconds of dwell time between test points.

Related Topics

- Typical sources of test errors
- Energy pulsing considerations
- Energy pulsing

Required pulses calculation for accuracy verification testing

Accuracy verification test equipment typically requires you to specify the number of pulses for a specific test duration.

The reference test equipment typically requires you to specify the number of pulses required for a test duration of "t" seconds. Normally, the number of pulses required is at least 25 pulses, and the test duration is greater than 30 seconds.

Use the following formula to calculate the required number of pulses:

$$\text{Number of pulses} = P_{\text{tot}} \times K \times t / 3600$$

Where:

- P_{tot} = total instantaneous power in kilowatts (kW)
- K = the meter's pulse constant setting, in pulses per kWh
- t = test duration, in seconds (typically greater than 30 seconds)

Total power calculation for accuracy verification testing

Accuracy verification testing supplies the same test signal (total power) to both the energy reference/standard and the meter under test.

Total power is calculated as follows, where:

- P_{tot} = total instantaneous power in kilowatts (kW)
- V_{LN} = test point line-to-neutral voltage in volts (V)
- I = test point current in amps (A)
- PF = power factor

The result of the calculation is rounded up to the nearest integer.

For a balanced 3-phase Wye system:

$$P_{\text{tot}} = 3 \times V_{\text{LN}} \times I \times PF \times 1 \text{ kW}/1000 \text{ W}$$

NOTE: A balanced 3-phase system assumes that the voltage, current and power factor values are the same for all phases.

For a single-phase system:

$$P_{\text{tot}} = V_{\text{LN}} \times I \times PF \times 1 \text{ kW}/1000 \text{ W}$$

Percentage error calculation for accuracy verification testing

Accuracy verification testing requires you to calculate the percentage error between the meter being tested and the reference/standard.

Calculate the percentage error for every test point using the following formula:

$$\text{Energy error} = (EM - ES) / ES \times 100\%$$

Where:

- EM = energy measured by the meter under test
- ES = energy measured by the reference device or energy standard.

NOTE: If accuracy verification reveals inaccuracies in your meter, they may be caused by typical sources of test errors. If there are no sources of test errors present, please contact your local Schneider Electric representative.

Accuracy verification test points

The meter should be tested at full and light loads and at lagging (inductive) power factors to help ensure testing over the entire range of the meter.

The test amperage and voltage input rating are labeled on the meter. Refer to the installation sheet or data sheet for your meter’s nominal current, voltage and frequency specifications.

Watt-hour test point	Sample accuracy verification test point
Full load	100% to 200% of the nominal current, 100% of the nominal voltage and nominal frequency at unity power factor or one (1).
Light load	10% of the nominal current, 100% of the nominal voltage and nominal frequency at unity power factor or one (1).
Inductive load (lagging power factor)	100% of the nominal current, 100% of the nominal voltage and nominal frequency at 0.50 lagging power factor (current lagging voltage by 60° phase angle).

VAR-hour test point	Sample accuracy verification test point
Full load	100% to 200% of the nominal current, 100% of the nominal voltage and nominal frequency at zero power factor (current lagging voltage by 90° phase angle).
Light load	10% of the nominal current, 100% of the nominal voltage and nominal frequency at zero power factor (current lagging voltage by 90° phase angle).
Inductive load (lagging power factor)	100% of the nominal current, 100% of the nominal voltage and nominal frequency at 0.87 lagging power factor (current lagging voltage by 30° phase angle).

Energy pulsing considerations

The meter’s energy pulsing LED and pulse outputs are capable of energy pulsing within specific limits.

Description	Energy pulsing LED	Pulse output
Maximum pulse frequency	2.5 kHz	25 Hz
Minimum pulse constant	1 pulse per k_h	
Maximum pulse constant	9,999,000 pulses per k_h	

The pulse rate depends on the voltage, current and PF of the input signal source, the number of phases, and the VT and CT ratios.

If Ptot is the instantaneous power (in kW) and K is the pulse constant (in pulses per kWh), then the pulse period is:

$$\text{Pulse period (in seconds)} = \frac{3600}{K \times P_{tot}} = \frac{1}{\text{Pulse frequency (Hz)}}$$

VT and CT considerations

Total power (P_{tot}) is derived from the values of the voltage and current inputs at the secondary side, and takes into account the VT and CT ratios.

The test points are always taken at the secondary side, regardless of whether VTs or CTs are used.

If VTs and CTs are used, you must include their primary and secondary ratings in the equation. For example, in a balanced 3-phase Wye system with VTs and CTs:

$$P_{tot} = 3 \times V_{LN} \times \frac{V_{T_p}}{V_{T_s}} \times I \times \frac{C_{T_p}}{C_{T_s}} \times PF \times \frac{1 \text{ kW}}{1000 \text{ W}}$$

where P_{tot} = total power, V_{T_p} = VT primary, V_{T_s} = VT secondary, C_{T_p} = CT primary, C_{T_s} = CT secondary and PF = power factor.

Example calculations

This example calculation shows how to calculate power, pulse constants and maximum pulse frequency, and how to determine a pulse constant that reduces the maximum pulse frequency.

A balanced 3-phase Wye system uses 480:120 volt VTs and 100:5 amp CTs. The signals at the secondary side are 119 volts line-to-neutral and 4.99 amps, with a power factor of 0.85. The desired pulse output frequency is 20 Hz (20 pulses per second).

1. Calculate the typical total output power (P_{tot}):

$$P_{tot} = 3 \times 119 \times \frac{480}{120} \times 4.99 \times \frac{100}{5} \times 0.85 \times \frac{1 \text{ kW}}{1000 \text{ W}} = 141.14 \text{ kW}$$

2. Calculate the pulse constant (K):

$$K = \frac{3600 \times (\text{pulse frequency})}{P_{tot}} = \frac{3600 \text{ seconds/hour} \times 20 \text{ pulses/second}}{121.14 \text{ kW}}$$

$$K = 594.4 \text{ pulses / kWh}$$

3. At full load (200% of nominal current = 10 A) and power factor (PF = 1), calculate the maximum total output power (P_{max}):

$$P_{max} = 3 \times 119 \times \frac{480}{120} \times 10 \times \frac{100}{5} \times 1 \times \frac{1 \text{ kW}}{1000 \text{ W}} = 285.6 \text{ kW}$$

4. Calculate the maximum output pulse frequency at P_{max}:

$$\text{Maximum pulse frequency} = \frac{K \times P_{max}}{3600} = \frac{594.4 \text{ pulses / kWh} \times 285.6 \text{ kW}}{3600 \text{ seconds/hour}}$$

$$\text{Maximum pulse frequency} = 47.2 \text{ pulses/second} = 47.2 \text{ Hz}$$

5. Check the maximum pulse frequency against the limits for the LED and digital outputs:

- 47.2 Hz ≤ LED maximum pulse frequency (2.5 kHz)
- 47.2 Hz > digital output maximum pulse frequency (25 Hz)

NOTE: The maximum pulse frequency is within the limits for LED energy pulsing. However, the maximum pulse frequency is greater than the limits for digital output energy pulsing. Pulse output frequencies greater than 25 Hz will saturate the digital output and cause it to stop pulsing. Therefore in this example, you can only use the LED for energy pulsing.

Adjustments to allow energy pulsing at the digital outputs

If you want to use the digital output, you must reduce the output pulse frequency so it is within the limits.

Using the values from the above example, the maximum pulse constant for the digital output is:

$$K_{\max} = \frac{3600 \times (\text{digital output maximum pulse frequency})}{P_{\max}} = \frac{3600 \times 2.5}{285.6}$$

$$K_{\max} = 315.13 \text{ pulses per kWh}$$

1. Set the pulse constant (K) to a value below K_{\max} , for example, 300 pulses/kWh. Calculate the new maximum output pulse frequency at P_{\max} :

$$\text{New maximum pulse frequency} = \frac{K \times P_{\max}}{3600} = \frac{300 \text{ pulses/kWh} \times 285.6 \text{ kWh}}{3600 \text{ seconds/hour}}$$

$$\text{New maximum pulse frequency} = 23.8 \text{ pulses/second} = 23.8 \text{ Hz}$$

2. Check the new maximum pulse frequency against the limits for the LED and digital outputs:

- $23.8 \text{ Hz} \leq \text{LED maximum pulse frequency (2.5 kHz)}$
- $23.8 \text{ Hz} \leq \text{digital output maximum frequency (25 Hz)}$

As expected, changing K to a value below K_{\max} allows you to use the digital output for energy pulsing.

3. Set the new pulse constant (K) on your meter.

Typical sources of test errors

If you see excessive errors during accuracy testing, examine your test setup and test procedures to eliminate typical sources of measurement errors.

Typical sources of accuracy verification testing errors include:

- Loose connections of voltage or current circuits, often caused by worn-out contacts or terminals. Inspect terminals of test equipment, cables, test harness and the meter under test.
- Meter ambient temperature is significantly different than 23 °C (73 °F).
- Floating (ungrounded) neutral voltage terminal in any configuration with unbalanced phase voltages.
- Inadequate meter control power, resulting in the meter resetting during the test procedure.
- Ambient light interference or sensitivity issues with the optical sensor.
- Unstable power source causing energy pulsing fluctuations.
- Incorrect test setup: not all phases connected to the reference device or the energy standard. All phases connected to the meter under test should also be connected to the reference meter/standard.
- Moisture (condensing humidity), debris or pollution present in the meter under test.

MID compliance

MID overview

Directive 2004/22/EC is the Measuring Instruments Directive (“MID”) from the European Parliament & Council that harmonizes many aspects of legal metrology across the EU states.

Scope

Although MID applies to various measuring instruments, the scope of this section is limited only to the MID standards that apply to AC electricity metering equipment:

- EN 50470-1:2006: Electricity metering equipment (a.c.) — Part 1: General requirements, tests and test conditions - Metering equipment (class indexes A, B and C)
- EN 50470-3:2006: Electricity metering equipment (a.c.) — Part 3: Particular requirements - Static meters for active energy (class indexes A, B and C)

Search the internet for “Measuring Instruments Directive” or “Directive 2004/22/EC” for more information.

MID compliance for the meter

The meter complies to these MID standards and class indexes: EN 50470-1:2006 Class C and EN 50470-3:2006 Class C.

The meter achieves MID compliance through application of Annex B (Type Examination) and Annex D (Declaration of Conformity to Type Based on Quality Assurance of the Production Process).

Terminal covers and MID compliance

The installation of both the voltage and current terminal covers is required to provide tamper evidence for MID installations.

See the meter installation sheet that was shipped with your meter, or download a copy at www.schneider-electric.com, for instructions on installing the terminal covers.

Related Topics

- Device specifications
- Default data display screen

Firmware version, model and serial number

You can view the meter’s firmware version (including OS, RS and Ethernet versions), model and serial number from the display panel or through the meter webpages.

- Using the display panel: Navigate to **Maint > Diag > Info**.
- Using the meter webpages: Navigate to **Diagnostics > Meter Information**.

NOTE: For MID compliance, the meter’s firmware upgrade functionality is permanently disabled. You cannot upgrade a PM5561 meter’s firmware. The OS CRC value is a number that identifies the uniqueness between different OS firmware versions.

MID-protected setup parameters

Selected setup parameters are permanently set at the factory and cannot be modified, regardless of the lock or unlock settings.

Alarm / energy pulsing LED

The alarm / energy pulsing LED on the meter is permanently set for energy pulsing and cannot be disabled or used for alarms. All other setup parameters for the energy pulsing LED are also permanently set and cannot be modified.

Setup menu	Setup submenu	MID-protected setup parameter
I/O	LED	<ul style="list-style-type: none"> Mode (Control) = Energy (energy pulsing) Pulses per k_h (Pulse Rate) = 10,000 (pulses per kWh) Channel (Parameter) = Active Energy Del +Rec

NOTE: The pulses per kWh reflect uncompensated values only. This means that the PT and CT values are ignored and the pulses represent the raw energy calculated from the metering inputs.

Lock-protected setup parameters

Selected setup parameters are lock-protected for MID compliance.

After the meter is locked, these setup parameters are protected and cannot be edited.

Setup menu	Setup submenu	Lock-protected setup parameter
Meter	Basic	<ul style="list-style-type: none"> Power System VT Connect VT Primary (V) and VT Secondary (V)¹ CT on Terminal CT Primary (A) CT Secondary (A) CT Primary Neu.(A) and CT Sec. Neu.(A)² Sys Frequency Phase Rotation
	Advanced	Label
	Tariff	Mode
HMI	User Passwords	Energy Resets
Clock		Date

Lock-protected functions

Selected meter functions are lock-protected for MID compliance.

After the meter is locked, these functions are disabled.

Menu	Submenu	Lock-protected function
Resets	Global Resets	<ul style="list-style-type: none"> Meter Initialization (all) Energies

1. If using VTs (i.e., if **VT Connect** is set to 3VT or 2VT)

2. For 3PH4W Wye Gnd systems that measure I4 current (i.e., if **CT on Terminal** is set to I1 I2 I3 IN)

Menu	Submenu	Lock-protected function
	Single Resets	<ul style="list-style-type: none"> • Energy • Multi-Tariff

PM5561 configuration

You must configure all the lock-protected setup parameters before locking the meter.

When the meter is locked, lock-protected setup parameters cannot be edited.

MID configuration considerations

Basic setup menu	For MID compliance, the Power System must be set to one of the following settings: <ul style="list-style-type: none"> • 3PH4W Wye Gnd (three-phase 4-wire wye grounded) • 3PH3W Dlt Ungnd (three-phase 3-wire delta ungrounded)
Advanced setup menu	You must use ION Setup to edit the device label.
Passwords setup menu	When the meter is locked, all other passwords can still be modified except for the Energy Resets password.

Locking or unlocking the PM5561

After you initialize the meter, you must lock it in order to conform to MID standards .

Before you lock your meter:

- Make sure you have completed all necessary configuration.
- Perform a meter initialization reset to clear any previously accumulated meter data.

A lost lock password cannot be recovered.

NOTICE
<p>PERMANENTLY LOCKED DEVICE</p> <p>Record your device's user and password information in a secure location.</p> <p>Failure to follow these instructions can result in data loss.</p>

1. Navigate to **Maint > Lock**.
2. Set **Security Lock** by entering a non-zero password (a number between 1 and 9999).
3. Select **Yes** to confirm locking the meter, then exit the screen.
A lock icon appears on the upper left corner of the screen.
4. Make sure you record and store the lock password in a secure location.

NOTE: To change the lock password, unlock the meter then lock it again using a different password. Make sure you record this new password and store it in a secure place.

Device specifications

The specifications contained in this section are subject to change without notice. See your product's technical datasheet at www.schneider-electric.com for the most current and complete specifications.

For installation and wiring information, refer to the meter installation sheet.

Mechanical characteristics

PM5560, PM5561 and PM5RD

IP degree of protection (IEC 60529)	Display: IP52 Meter body: IP30 (except connectors) Connectors: IP20 with terminal covers installed, IP10 without terminal covers
Enclosure rating	Display: UL Type 12 For UL Type 12 applications, install meter and remote display on a flat surface of a Type 12 enclosure
Mounting position	Vertical
Display type	Monochrome graphics LCD, 128 x 128 resolution
Display backlight	White LED
Viewable area	67 x 62.5 mm (2.64 x 2.46 in)

PM5563

IP degree of protection (IEC 60529)	Meter body: IP30 (except connectors) Connectors: IP20 with terminal covers installed, IP10 without terminal covers
Mounting position	35 mm DIN rail

Electrical characteristics

Measurement accuracy

Measurement type	True RMS up to the 63rd harmonic on three-phase (3P, 3P + N) 128 samples per cycle, zero blind
IEC 61557-12	PMD/[SD SS]/K70/0.2
Active energy	±0.2% Class 0.2S, as per IEC 62053-22
Reactive energy	±2% Class 2, as per IEC 62053-23
Active power	±0.2% as per IEC 61557-12
Reactive power	±1% as per IEC 61557-12
Apparent power	±0.5% as per IEC 61557-12
Current (5 A nominal, per phase)	±0.15%
Voltage (L-N)	±0.1%
Frequency	±0.05%

Power quality accuracy (IEC 61557-12)

Voltage unbalance	2.0%
Voltage harmonics	2.0%

Power quality accuracy (IEC 61557-12)

Voltage THD	2.0%
Current harmonics	2.0%
Current THD	2.0%

Voltage inputs

Maximum VT/PT primary	1.0 MV AC
Specified accuracy range	20 – 400 V L-N / 20 – 690 V L-L (Wye) or 20 – 600 V L-L (Delta) UL Listed up to 347 V L-N / 600 V L-L
Measurement category	CAT III (6 kV rated impulse voltage)
Overload	480 V L-N / 828 V L-L
Impedance	5 M Ω
Specified accuracy frequency	50 or 60 Hz \pm 10% (45 – 70 Hz)

Current inputs

Maximum CT primary	32767 A
CT secondary	Nominal: 5 A (Class 0.2S) or 1 A (Class 0.5S)
Measured current with overrange and crest factor	50 mA – 10 A
Starting current	5 mA
Withstand	20 A continuous 50 A at 10 sec/hr 500 A at 1 sec/hr
Impedance	0.3 m Ω
Frequency	50 or 60 Hz \pm 10% (45 – 70 Hz)
Burden	0.024 VA at 10 A

AC control power

Operating range	100 – 480 V AC \pm 10%
Installation category	CAT III 600V class per IEC 61010-1 edition 3
Burden	5.0 W / 16.0 VA / 15.2 VAR max at 480 V AC
Frequency	50 or 60 Hz \pm 10%
Ride-through time	35 ms typical at 120 V L-N and maximum burden 129 ms typical at 230 V L-N and maximum burden

DC control power

Operating range	125 – 250 V DC \pm 20%
Burden	3.1 W typical, 5.0 W maximum at 125 V DC
Ride-through time	50 ms typical at 125 V DC and maximum burden

Digital outputs

Number	2
Type	Form A solid-state digital outputs
Maximum load voltage	30 V AC / 60 V DC
Maximum load current	125 mA
ON resistance	8 Ω
Pulse frequency	25 Hz maximum

Digital outputs

Pulse weight	1 to 9,999,999 pulses per kWh
Pulse width	50% duty cycle (20 ms minimum ON time)
Leakage current	1 micro Amps
Isolation	2.5 kV RMS for 60 seconds

Digital inputs

Number	4
Type	Externally excited
Voltage OFF	0 – 6 V AC / 0 – 6 V DC
Voltage ON	15 – 30 V AC / 15 – 60 V DC
Input resistance	100 kΩ
Frequency	25 Hz maximum
Isolation	2.5 kV RMS for 60 seconds
Pulse width	50% duty cycle (20 ms minimum ON time)
Response time	10 ms
Input burden	2 mA at 24 V AC/DC 2.5 mA at 60 V AC/DC

Environmental characteristics

Operating temperature	Meter: -25 to 70 °C (-13 to 158 °F) Display: -20 to 70 °C (-4 to 158 °F) Display functions to -25 °C (-13 °F) with reduced performance
Storage temperature	-40 to 85 °C (-40 to 185 °F)
Humidity rating	Operating: 5% to 95% RH non-condensing Storage: 5% to 80% RH non-condensing Maximum dewpoint 37 °C (99 °F)
Pollution degree	2
Altitude	< 3000 m (9843 ft)
Location / mounting	Not suitable for wet locations For indoor use only Must be permanently connected and fixed

LEDs**LED indicators**

Heartbeat / communications activity	Green LED (front panel on display or remote display, top on DIN model)
Alarm / energy pulsing LED	Amber LED (front panel on display or remote display, top on DIN model)

Active alarm / energy pulsing LED

Type	Amber LED, optical
Maximum pulse frequency	2.5 kHz
Pulse width	50% duty cycle (200 microseconds minimum ON time)

Active alarm / energy pulsing LED

Pulse weight	1 to 9,999,999 pulses per kWh
Wavelength	590 to 635 nm

EMC (electromagnetic compatibility)

Harmonic current emissions	IEC 61000-3-2
Flicker (voltage fluctuation) limits	IEC 61000-3-3
Immunity to electrostatic discharge	IEC 61000-4-2
Immunity to radiated fields	IEC 61000-4-3
Immunity to fast transients	IEC 61000-4-4
Immunity to surges	IEC 61000-4-5
Immunity to conducted disturbances, 150kHz to 80MHz	IEC 61000-4-6
Immunity to magnetic fields	IEC 61000-4-8
Immunity to voltage dips and interruptions	IEC 61000-4-11
Immunity to damped oscillatory waves	IEC 61000-4-12
Radiated and conducted emissions	FCC part 15 Class B, EN55022 Class B

Safety

Europe	LVD compliance (EN61010-1:2010)
U.S. and Canada	cULus (UL61010-1:2012, CSA22.2 No.61010-1-12)
Protective class	Protective class II Double insulated for user accessible parts

MID compliance

Additional specifications apply to the MID meter model.

Applicable MID standards and class index	<ul style="list-style-type: none"> EN 50470-1:2006 Class C EN 50470-3:2006 Class C
Type of measuring equipment	Static watt-hour meter
Intended use	Indoor use only, permanently mounted in residential, commercial or light industrial applications, where levels of vibration and shock are of low significance
Mechanical environment	M1
Electromagnetic (EMC) environment	E2
Applicable measurements	Active energy metering only (kWh or MWh)
Voltage at voltage terminals	<ul style="list-style-type: none"> 3-phase 4-wire Wye grounded: 3 x 57.7 (100) to 3 x 400 (690) V AC 3-phase 3-wire Delta ungrounded: 3 x 100 to 3 x 600 V L-L
Electrical network frequency	50 Hz

RS-485 communications

Number of ports	1
Maximum cable length	1219 m (4000 ft)
Maximum number of devices (unit loads)	Up to 32 devices on the same bus
Parity	Even, Odd, None (1 stop bit for Odd or Even parity; 2 stop bits for None)
Baud rate	9600, 19200, 38400 baud
Protocol	Modbus RTU, Modbus ASCII (7 or 8 bit), JBUS
Isolation	2.5 kV RMS, double insulated

Ethernet communications

Number of ports	2
Maximum cable length	100 m (328 ft), per TIA/EIA 568-5-A
Mode	10Base-T, 100Base-TX, Auto-MDIX
Protocol	Modbus TCP, HTTP, FTP, DHCP, BOOTP

Real-time clock

Clock drift	~ 0.4 seconds per day (typical)
Battery backup time	4.5 years without control power (typical)

Schneider Electric
35 rue Joseph Monier
92500 Rueil Malmaison
France

+ 33 (0) 1 41 29 70 00

www.schneider-electric.com

As standards, specifications, and design change from time to time,
please ask for confirmation of the information given in this publication.

© 2016 – Schneider Electric. All rights reserved.

HRB1684301-04