

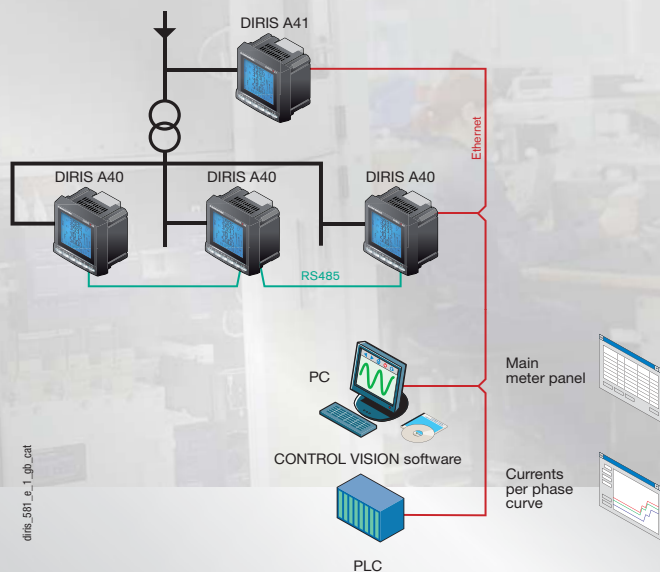

Applications



Monitoring and managing energy for high/low voltage electrical installations

Function

The DIRIS A40 and A41 are multifunction meters which ensure the user has access to all the measurements required for energy efficiency projects and monitoring of electrical distribution.

All this information can be used and analysed remotely using the CONTROL VISION software.

Conformity to standards

- IEC 61557-12
- IEC 62053-22 class 0.5S
- IEC 62053-23 class 2

Multi measurement

- Current
 - instantaneous: I1, I2, I3, In, Isystem
 - average/maximum average: I1, I2, I3, In
- Voltages & frequency
 - instantaneous: U1, U2, U3, U12, U23, U31, F, Vsystem, Ussystem
 - average/maximum average: U1, U2, U3, U12, U23, U31, F
- Power
 - instantaneous: 3P, ΣP, 3Q, ΣQ, 3S, ΣS
 - average/maximum average: ΣP, ΣQ, ΣS
 - predictive: (ΣP), (ΣQ), (ΣS)
- Power factor
 - instantaneous: 3PF, ΣPF
 - average/maximum average: ΣPF
- Temperatures⁽¹⁾
 - internal
 - external via 3 PT100 sensors

Metering

- Active energy: +/- kWh
- Reactive energy: +/- kvarh
- Apparent energy: kVAh
- Hours: ⌚

Harmonic analysis

- Harmonic distortion rate
 - Currents: thd I1, thd I2, thd I3, thd In
 - Phase-to-neutral voltage: thd U1, thd U2, thd U3
 - Phase to phase voltage: thd U12, thd U23, thd U31

- Individual up to level 63
 - Currents: HI1, HI2, HI3, HIn
 - Phase-to-neutral voltage: HU1, HU2, HU3,
 - Phase to phase voltage: HU12, HU23, HU31

Load curves⁽¹⁾

- Active and reactive power: ΣP+/-; ΣQ+/-
- Voltages & frequency: U1, U2, U3, U12, U23, U31, F

Events⁽¹⁾

- Alarms on all electrical values.

Communications⁽¹⁾

- Analogues 0/4- 20 mA
- Digital RS485 (Jbus/Modbus & Profibus-DP)
- Ethernet (modbus/TCP or Jbus/Modbus RTU over TCP and Web server)
- Ethernet with RS485 gateway Jbus/Modbus RTU over TCP

Inputs / Outputs⁽¹⁾

- Pulse metering
- Remote control/command
- Alarm report
- Pulse report

⁽¹⁾ Available as an option (see the following pages).

➔ Front panel



1. Backlit LCD screen.
2. Pushbutton for currents and setup wiring correction
3. Pushbutton for voltages and frequency.
4. Pushbutton for active, reactive, and apparent power and power factor.
5. Pushbutton for maximum and average current and power values.
6. Pushbutton for harmonics values.
7. Pushbutton for pulse, hours and electrical energy meters.

➔ Plug-in modules

DIRIS® A40



DIRIS® A41



	<p>Pulse outputs</p> <p>2 configurable pulse outputs (type, weight and run) on \pm kWh, \pm kvarh and kVAh</p>
	<p>JBUS / MODBUS® communication</p> <p>RS485 link with JBUS / MODBUS® protocol (speed up to 38400 bauds).</p>
	<p>PROFIBUS® DP communication</p> <p>SUB-D9 link with PROFIBUS® DP protocol (speed up to 12 Mbauds).</p>
	<p>Ethernet communication</p> <ul style="list-style-type: none"> • Ethernet link with MODBUS/TCP or JBUS/MODBUS RTU over TCP
	<p>Ethernet communication with RS485 JBUS/MODBUS gateway</p> <ul style="list-style-type: none"> • Ethernet link with MODBUS/TCP or JBUS/MODBUS RTU over TCP • Connection of 1 to 247 RS485 JBUS/MODBUS slaves
	<p>Analogue outputs</p> <p>A maximum of 2 modules may be connected, that is 4 analogue outputs. 2 outputs assignable to: 3I, In, 3V, 3U, F, $\pm$$\Sigma$P, $\pm$$\Sigma$Q, ΣS, ΣPFL/C, I sys, Vsys, Usys, Ppred, Q pred, Spred, internal T°C, T°C 1, T°C 2, T°C 3 and to 17 VDC power supply</p>
	<p>2 inputs - 2 outputs</p> <p>A maximum of 3 modules may be connected, giving 6 inputs. 2 outputs assignable to: - monitoring: 3I, In, 3V, 3U, F, $\pm$$\Sigma$P, $\pm$$\Sigma$Q, SS, ΣPFL/C, THD 3I, THD In, THD 3V, THD 3U, Ppred, Qpred, Spred, internal T°C, T°C 1, T°C2, T°C3 and hour meter, - remote control, - timed remote control.</p>
	<p>Memory</p> <ul style="list-style-type: none"> • Storing up to a maximum of 62 days of P+, P-, Q+, Q- with an internal or external synchronisation signal of 5, 8, 10, 15, 20, 30 and 60 minutes. • Storing of 10 hour-dated last alarms. • Storing of the last minimum and maximum instantaneous values for 3U, 3V, 3I, In, F, ΣP\pm, ΣQ\pm, ΣS, THD 3U, THD 3V, THD, 3U, THD, 3V, THD, 3I, THD In. • Storing of 3U, 3V and F average values based on synchronisation function (maximum 60 days).
	<p>Temperature</p> <p>Temperature indication</p> <ul style="list-style-type: none"> • Internal • External sensor PT 100 (T°C 1) • External sensor PT 100 (T°C 2) • External sensor PT 100 (T°C 3)

↳ DIRIS A40 / A41 - Accessories

Current transformer
(see page 334)

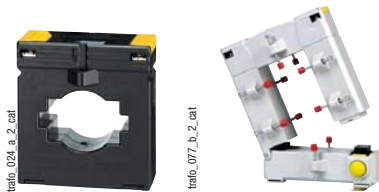

IP65 protection



Mounting kit for 144 x 96 mm cut out plate



↳ Terminals

DIRIS A40

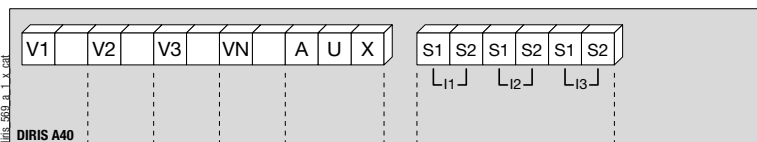

S1 - S2: current inputs

AUX: auxiliary power supply U_s
V1 - V2 - V3 - VN: voltage inputs

DIRIS A41

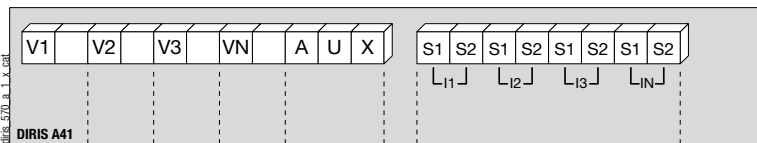

S1 - S2: current inputs

AUX: auxiliary power supply U_s
V1 - V2 - V3 - VN: voltage inputs

Communication module

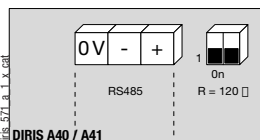

DIRIS A40 / A41
RS485 link.
R = 120 Ω : internal resistance for the RS485 link.

Pulse output module

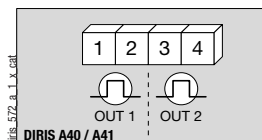

DIRIS A40 / A41
1 - 2: pulse output n°1.
3 - 4: pulse output n°2.

Analogue output module

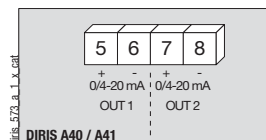

DIRIS A40 / A41
5 - 6: analogue output n°1.
7 - 8: analogue output n°2.

2 inputs / 2 outputs module

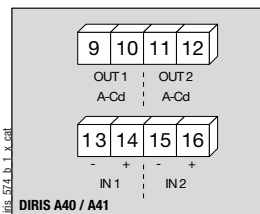

DIRIS A40 / A41
9 - 10: relay output n°1.
11 - 12: relay output n°2.
13 - 14: opto input n°1.
15 - 16: opto input n°2.

Memory module

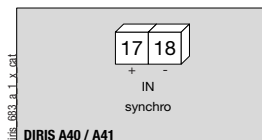

DIRIS A40 / A41
17 - 18: synchronisation input.

Temperature module

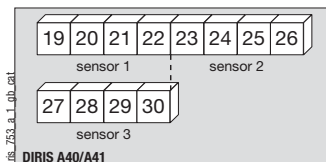

DIRIS A40/A41

Sensor 1	Sensor 2	Sensor 3
19: Red	23: Red	27: Red
20: Red	24: Red	28: Red
21: White	25: White	29: White
22: White	26: White	30: White

Ethernet Module

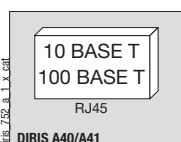

DIRIS A40/A41

Ethernet module + RS485 JBUS / MODBUS gateway

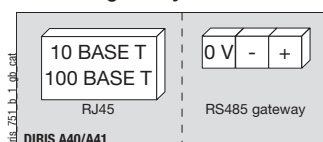

DIRIS A40/A41

Electrical characteristics

Current measurement on insulated inputs (TRMS)	
Via CT primary	10 000 A
Via CT secondary	1 or 5 A
Measurement range	0 ... 11 kA
Input consumption	≤ 0.1 VA
Measurement updating period	1 s
Accuracy	0.2 %
Sustained overload	6 A
intermittent overload	10 I _n for 1 s

Voltage measurements (TRMS)	
Direct measurement between phases	50 ... 700 VAC
Direct measurement between phase and neutral	28 ... 404 VAC
VT primary	500 000 VAC
VT secondary	60, 100, 110, 173, 190 VAC
Frequency	50 / 60 Hz
Input consumption	≤ 0.1 VA
Measurement updating period	1 s
Accuracy	0.2 %
Sustained overload	760 VAC

Current-voltage product	
Limitation for 1A CT	10 000 000
Limitation for 5A CT	10 000 000

Power measurement	
Measurement updating period	1 s
Accuracy	0.5 %

Power factor measurement	
Measurement updating period	1 s
Accuracy	0.5 %

Frequency measurement	
Measurement range	45 ... 65 Hz
Measurement updating period	1 s
Accuracy	0.1 %

Energy accuracy	
Active (according to IEC 62053-22)	class 0.5 S
Reactive (according to IEC 62053-23)	class 2

Auxiliary power supply	
Alternating voltage	110 ... 400 VAC
AC tolerance	± 10 %
Direct voltage	120 ... 350 VDC / 12 ... 48 VDC
DC tolerance	± 20 % / - 6 ... + 20 %
Frequency	50 / 60 Hz
Consumption	≤ 10 VA

2 inputs / 2 outputs module: Outputs (alarms / control)	
Number of relays	2 ⁽¹⁾
Type	250 VAC - 5 A - 1150 VA

2 inputs / 2 outputs module: Phototransistor inputs	
Number	2 ⁽¹⁾
Power supply	10 ... 17 VDC
Minimal signal width	10 ms
Minimum length between 2 impulses	18 ms
Type	phototransistor

Pulse outputs module	
Number of relays	2
Type	100 VDC - 0.5 A - 10 VA
Max. number of operations	≤ 10 ⁶

Analogue output module	
Number of outputs	2 ⁽²⁾
Type	insulated
Scale	0 / 4 ... 20 mA
Load resistance	600 Ω
Maximum current	30 mA

JBUS/MODBUS communication module	
Link	RS485
Type	2 ... 3 half duplex wires
Protocol	JBUS/MODBUS® in RTU mode
JBUS/MODBUS® speed	1400 ... 38400 bauds

PROFIBUS-DP communication module	
Link	SUB-D9
Protocol	PROFIBUS® DP
PROFIBUS® speed	9.8 kbauds ... 12 Mbauds

Ethernet Communication Module	
Connectique	RJ45
Speed	10 base T / 100 base T
Protocol	MODBUS TCP or JBUS/MODBUS RTU over TCP

Module temperature (inputs)	
Type	PT100
Connection	2, 3 or 4 wires
Dynamic	- 20°C ... 150°C
Accuracy	+/- 1 digit
Maximum length	300 cm

Operating conditions	
Operating temperature	- 10 ... + 55 °C
Storage temperature	- 20 ... + 85 °C
Relative humidity	95 %

(1) Max. 3 modules / DIRIS.
(2) Max. 2 modules / DIRIS.

Case

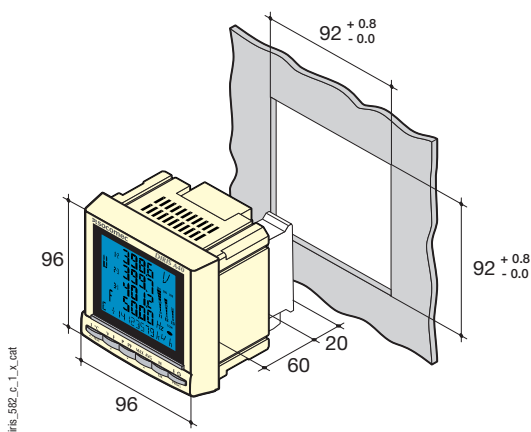

Type	Panel mounting
Dimensions W x H x D	96 x 96 x 60 mm
Case protection index	IP30
Front protection rating	IP52
Display type	LCD
Terminal blocks type	fixed or pull-out
Voltage and other connection section	0.2 ... 2.5 mm ²
Current connection section	0.5 ... 6 mm ²
Weight	400 g

➔ DIRIS A40 / A41 - Connections

Recommendation: when disconnecting the DIRIS, the secondaries of each current transformer must be short-circuited. This operation can be carried out automatically by a product in the SOCOMEC catalogue, PTI: consult us.
In TNC neutral system it is recommended to use functional earth module.

Low voltage balanced network for DIRIS A40

3/4 wires with 1 CT

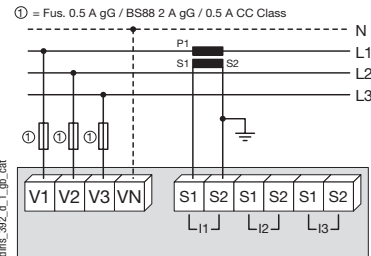

Use of 1 CT reduces by 0.5% the accuracy of the phases, the current of which is worked out by vector calculation.

Single phase

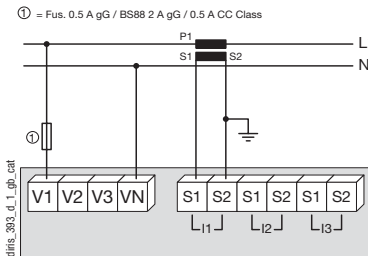

Two phase

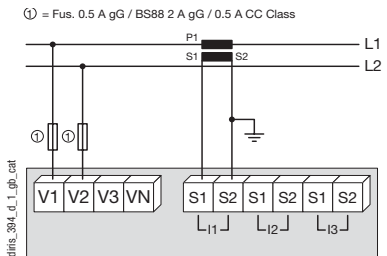

Low voltage unbalanced network for DIRIS A40

3/4 wires with 3 CTs

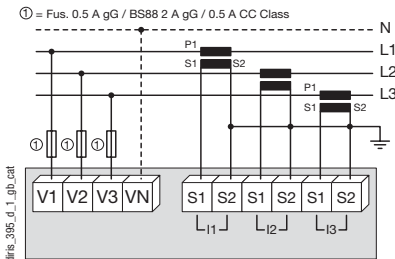

3 wires with 2 CTs

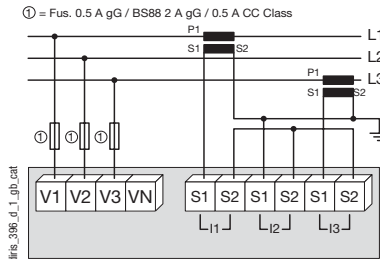

Use of 2 CTs reduces by 0.5% the accuracy of the phase, whose current is worked out by vector calculation.

3 wires with 2 CTs

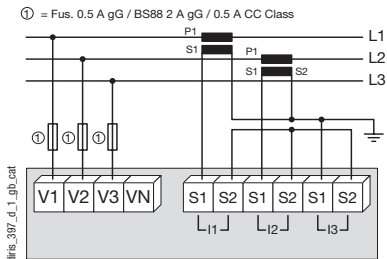

Use of 2 CTs reduces by 0.5% the accuracy of the phase, whose current is worked out by vector calculation.

Low voltage unbalanced network for DIRIS A41

4 wires with 4 CTs

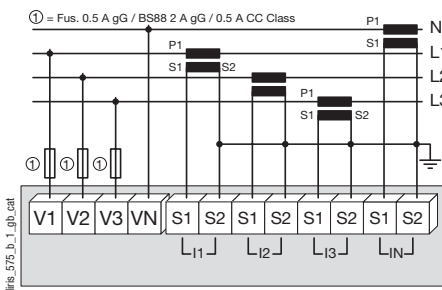

Additional information

Communication via RS485 link

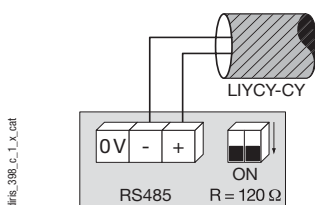

Voltage transformer for HV networks

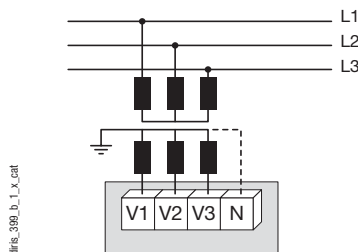

AC & DC auxiliary power supply

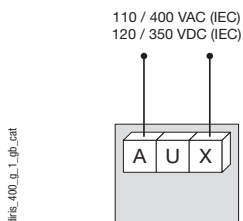

It is recommended that the auxiliary power supply be protected by the use of 500 mA gG fuses.

➔ References



DIRIS A41, a. 1. cat.

Basic device	DIRIS A40	DIRIS A41
Auxiliary power supply U _s	Reference	with CT on the neutral Reference
110 ... 400 VAC / 120 ... 350 VDC	4825 0201	4825 0202
12 ... 48 VDC	4825 1201	4825 1202

Options

Plug-in modules ⁽¹⁾	Reference	Reference
Pulse outputs	4825 0090	4825 0090
Sub D9 JBUS/MODBUS [®] communication	4825 0092	4825 0092
Analogue outputs	4825 0093	4825 0093
2 inputs / 2 outputs	4825 0094	4825 0094
RS485 PROFIBUS [®] DP communication	4825 0205	4825 0205
Memory	4825 0097	4825 0097
Ethernet communication	4825 0203	4825 0203
Ethernet communication + RS485 gateway JBUS/MODBUS	4825 0204	4825 0204
Temperature inputs	4825 0206	4825 0206
Functional Earth	4825 0087	4825 0087

Accessories

Description of accessories	To be ordered in multiples of		To be ordered in multiples of	
		Reference		Reference
IP65 protection	1	4825 0089	1	4825 0089
Panel mounting kit for a 144 x 96 mm cutout	1	4825 0088	1	4825 0088
Fuse combination switches for the protection of voltage inputs (type RM) 3 poles	4	5601 0018	4	5601 0018
Fuse combination switches for the protection of the auxiliary supply (type RM) 1 pole + neutral	6	5601 0017	6	5601 0017
Fuses type gG 10x38 0.5 A	10	6012 0000	10	6012 0000
Current transformers range		See page 334		See page 334

(1) Ease of integration for additional functions (maximum 4 on A40 and 3 on A41).

➔ Services and Technical assistance

Our expertise extends to a complete offer of services like commissioning installation audit, training, maintenance and project engineering.

