

CONTI SYNCHROBELT® HTD Synchronous Drive Belts

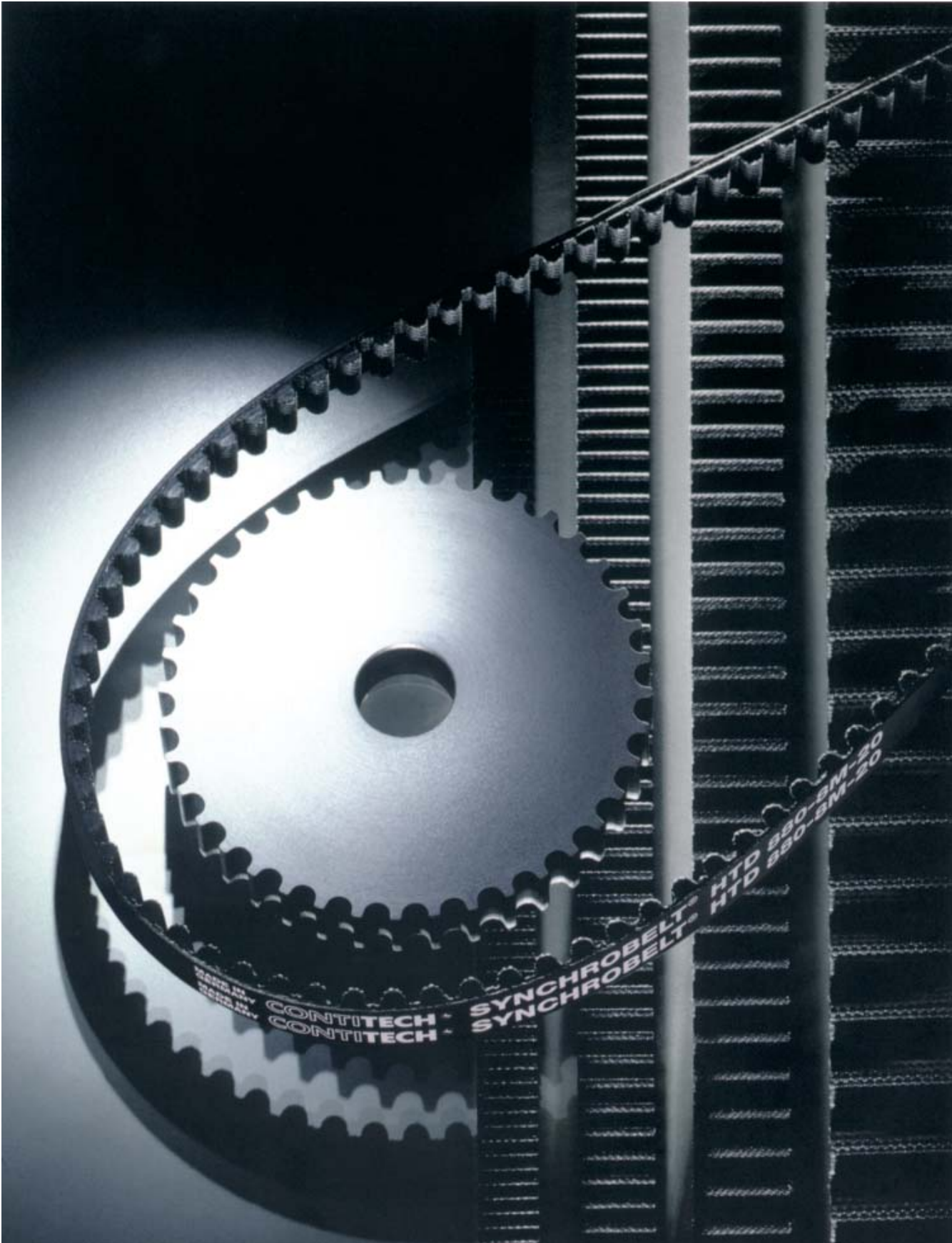

ContiTech
Specialist in rubber
and plastics technology

The ContiTech Division is a development partner and original equipment manufacturer for many branches of industry: with high-grade functional parts, components and systems. It is part of the Continental AG with 8 business units specialising in rubber and plastics technology and utilising their common know-how.

That's what the ContiTech brand is all about.

CONTITECH 

- 3-18 ___ **1 CONTI SYNCHROBELT®
HTD Synchronous Drive Belts**
- 4-7 ___ Properties
- 8 ___ Construction
- 9 ___ Designation
- 9-14 ___ Available belt range
- 15/16 ___ Length measurement
- 17 ___ Tolerances

- 19-32 ___ **2 HTD Toothed Pulleys**
- 20 ___ Material
- 20 ___ Flanged pulleys
- 21 ___ Designation
- 22-30 ___ Pulley diameters
- 31 ___ Tolerances
- 32 ___ Balancing

- 33-76 ___ **3 Design of Synchronous
Belt Drives**
- 34/35 ___ Symbols, units, terms
- 35-44 ___ Design data
- 45-47 ___ Calculation example
- 48-67 ___ Power ratings
- 63-75 ___ Centre distance factors
- 76 ___ ContiTech drive design service

- 77/78 ___ **4 Assembly and Storage**

- 79/80 ___ **Index**



Properties	Available Belt Range
Construction	Length Measurement
Designation	Tolerances

CONTI SYNCHROBELT® HTD Synchronous Drive Belts

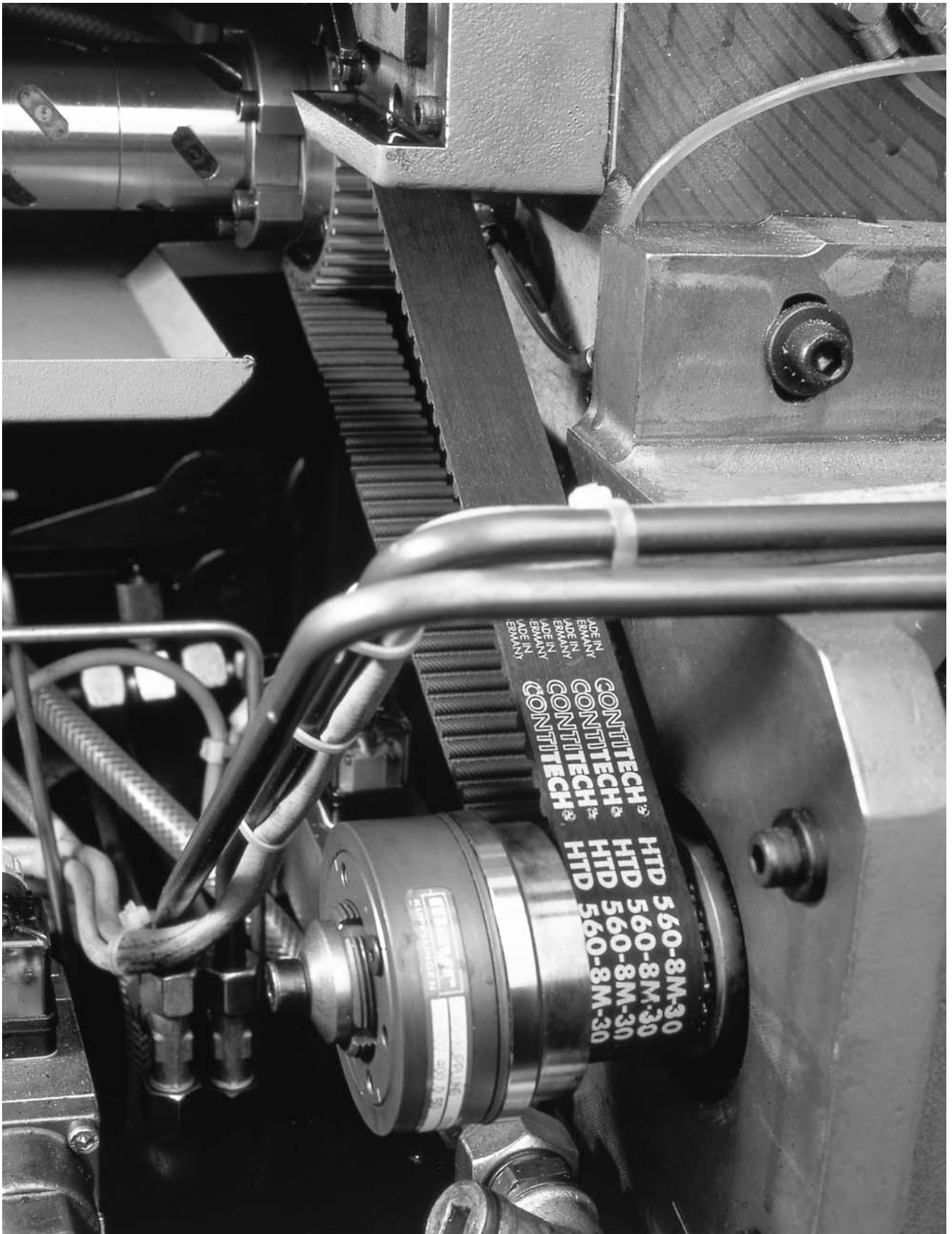

CONTI SYNCHROBELT® HTD Belt Drive
in a kale cutting device

Progress in the Transmission of High Torques: CONTI SYNCHROBELT® HTD Synchronous Drive Belts

The CONTI SYNCHROBELT® HTD synchronous drive belt offers more than a standard toothed belt. Its designation, HTD = High Torque Drive, stands for the transmission of high torques.

It features a completely new tooth-profile design as an advancement of the trapezoidal toothed belt, resulting in a uniform transmission of power when the teeth are in mesh, in a better transfer of belt tension to the tension cord, a uniform distribution of stresses within the tooth itself and, thus, in a minimum tooth deformation.

With CONTI SYNCHROBELT® HTD, synchronous belt drives become more economical, safer, and they render possible a synchronous transmission equivalent to chain and gear drives.

The CONTI SYNCHROBELT® HTD synchronous drive belt stands for progress, advanced technology and economy. Its field of application is continuously growing: application areas include tool manufacture, machine, motor and engine construction: printing, textile and paper making machines: printers, copying and office machinery: electric tools and household appliances.

Stress Distribution in Synchronous Drive Belts with Standard and CONTI SYNCHROBELT® HTD Tooth Profile

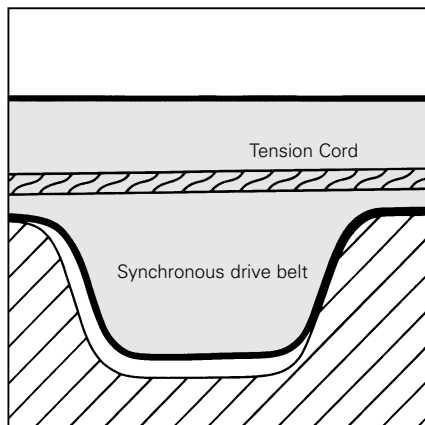

Trapezoidal profile

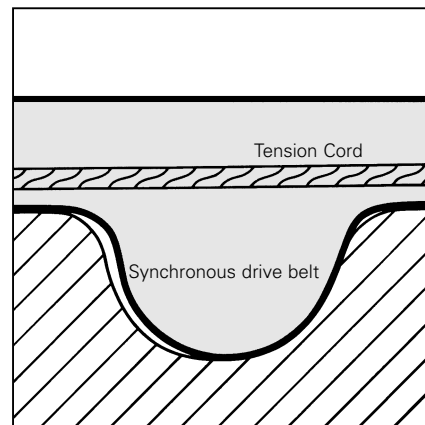

CONTI SYNCHROBELT® HTD tooth profile

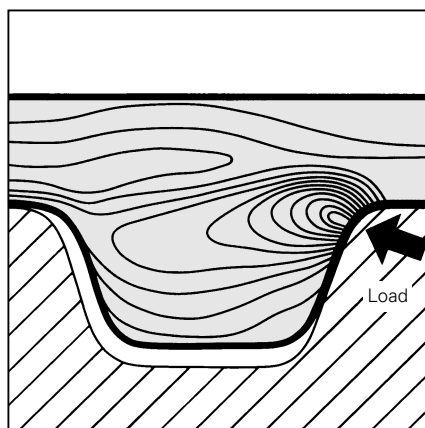

Stress distribution in the trapezoidal tooth

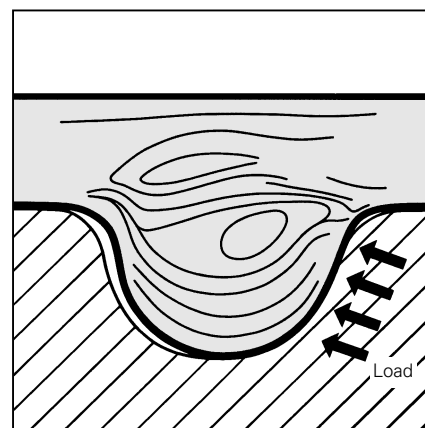

Stress distribution in the CONTI SYNCHROBELT® HTD tooth

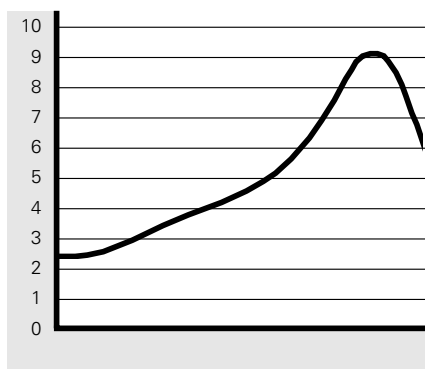

Load distribution across the tooth

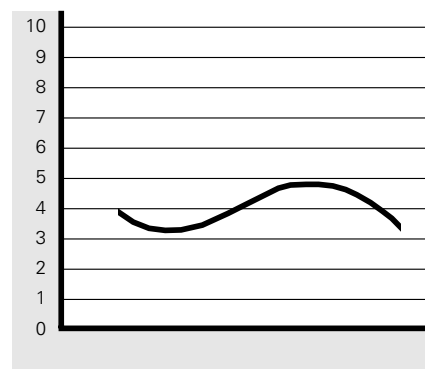

Load distribution across the tooth

CONTI SYNCHROBELT® HTD Synchronous Drive Belts offer the following advantages:

Positive Drive System Without Slippage

In the same way as with a gear drive, the belt's teeth mesh with the tothing of the drive pulleys. The special tooth profile of belt and pulleys guarantees a precise synchronism and a high degree of safety against tooth jump.

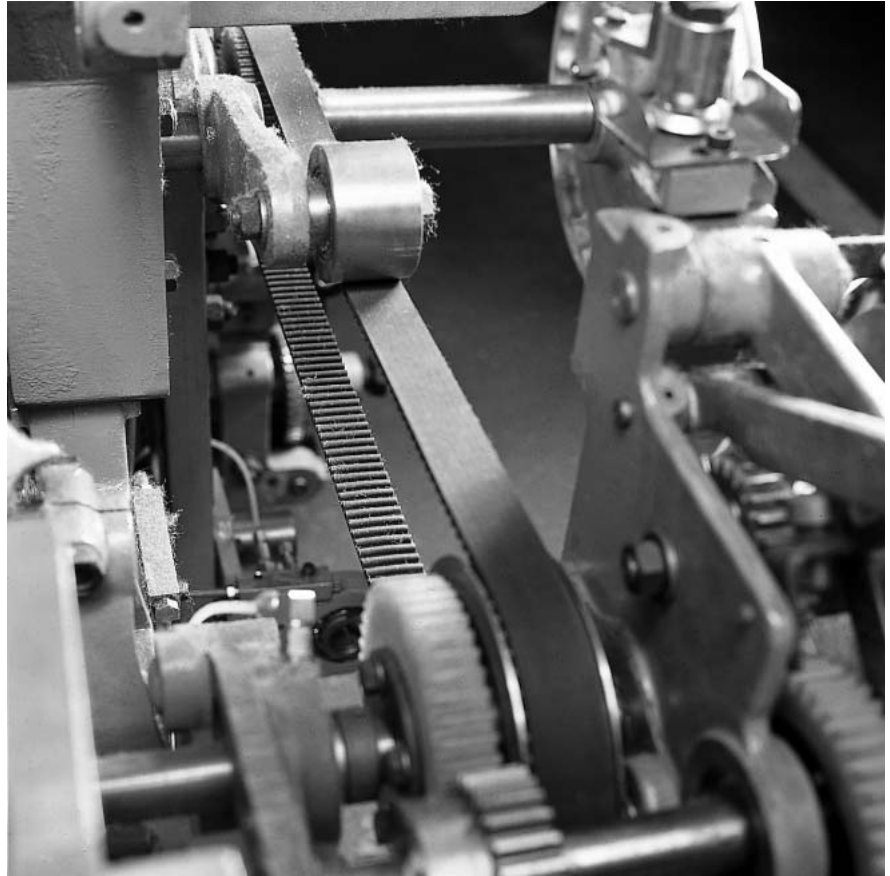

High Power Output

The rounded HTD tooth profile combined with the wear resistant facing fabric as well as with the high dynamic load-bearing capacity of the tension cord ensures operating efficiency

HTD synchronous drive belts render possible a positive transmission of power for high torques in such fields of application where only chain drives or gears drives have been made use of to date.

Minimum Space Requirements

The high power output renders possible the design of heavy-duty drives with compact construction and a low weight.

Extensive Speed Range

The high strength of the belt teeth as well as the excellent flexibility of the synchronous drive belts render possible operationally safe and reliable drive versions in the lower speed range and at belt speeds up to 50 m/s.

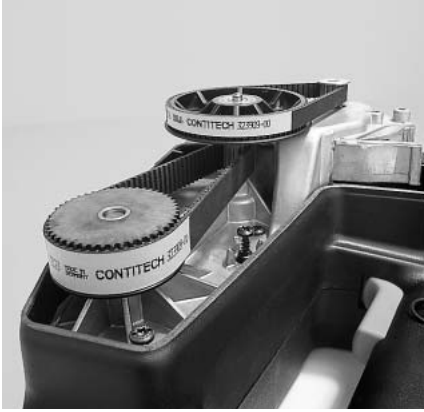

Low Synchronous Drive Belt Tension

The positive transmission of power requires only low initial tensioning. The HTD tooth profile guarantees a high degree of safety against tooth jump. So the axle and bearing loads stay low.

No Lubrication and Maintenance

CONTI SYNCHROBELT® HTD synchronous drive belts are free from maintenance: no lubrication and retensioning required. HTD synchronous drive belts are insensitive to corrosion and stable in length.

Low-Noise Running

The flexible synchronous drive belt construction, the frictionless meshing of the teeth and the combination of fabric-faced rubber teeth with toothed pulleys of metal or of synthetic material reduce the running noise to a minimum.

High Efficiency

The flexible synchronous drive belt construction as well as the exact dimensional match of the tooth profile of the belts and pulleys allow drives with an efficiency of 98%.

CONTI SYNCHROBELT® HTD synchronous drive belts of the standard version are

- oil resistant to a degree
- tropics-resistant
- remain stable over a temperature range from -20°C to +100°C according to application
- ozone-resistant
- insensitive to weathering.



Construction

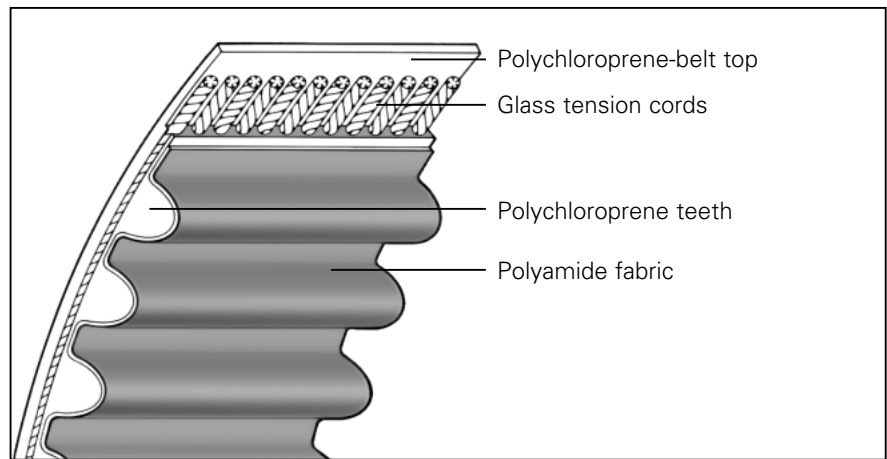

These are the components of the synchronous drive belt:

- Teeth and belt top of polychloroprene
- Polyamide fabric (facing fabric)
- Glass tension cords.

Teeth and Belt Top of Polychloroprene

The teeth and the belt top are made from highly loadable polychloroprene based elastomer materials. A special manufacturing process ensures an excellent adhesion both on the tensile member and on the facing fabric.

Polyamide Fabric

A durable protection of the teeth is an essential precondition for a smooth operation and a long service life. This is ensured by the application of particularly abrasion-resistant polyamide fabrics with low friction coefficients.

Glass Tension Cords

Synchronous belt drives call for a high degree of length stability and tensile strength. These requirements are optimally met by low-elongation tensile members of glass cord helically wound over the entire belt width. Any longitudinal off-track running will be largely prevented by the use of tensile cords twined in reversed lay in pairs.

Further design features:

- High resistance to fatigue failure
- Temperature and ageing-resistant
- High resistance to tearing.

Designation

CONTI SYNCHROBELT® HTD synchronous drive belts are designated by the following data:

- Pitch length in mm
The pitch length of the synchronous drive belt is the overall circumference measured on the neutral pitch line. The pitch length is located in the middle of the tensile member. The precise pitch length can only be ascertained on suitable measuring devices. See section "Length Measurement" (page 15) for further information.
- Tooth pitch in mm
The tooth pitch is the linear distance between two adjacent teeth along the pitch line.
- Synchronous drive belt width in mm
The synchronous drive belt width and the width designation are identical.

Example

CONTI SYNCHROBELT® HTD synchronous drive belt 960 – 8M – 50

960 _____ 960 mm pitch length

8M _____ 8 mm tooth pitch

50 _____ 50 mm synchronous drive belt width

The number of teeth z is a function of pitch length and pitch:

$$z = \frac{L_w}{t}$$

Available Belt Range

CONTI SYNCHROBELT® HTD synchronous drive belts are made use of in the entire drive technology sector, from the field of precision mechanics to the construction of heavy machinery. A comprehensive standard programme has been established for all these loads and conditions of application.

CONTI SYNCHROBELT® HTD synchronous drive belts are supplied in 5 tooth pitch versions:

HTD 3M:	3 mm tooth pitch
HTD 5M:	5 mm tooth pitch
HTD 8M:	8 mm tooth pitch
HTD 14M:	14 mm tooth pitch

The length and width dimensions that can be supplied are shown in the tables 1–5 (pages 10–14).

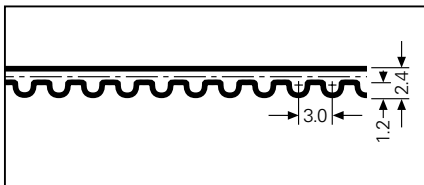

Tooth Profile HTD 3M

Standard lengths

Table 1

Designation	Pitch length L_w (mm)	No. of teeth z
111 – 3M	111	37
117 – 3M*	117	39
129 – 3M	129	43
141 – 3M*	141	47
144 – 3M	144	48
150 – 3M	150	50
156 – 3M*	156	52
159 – 3M	159	53
168 – 3M	168	56
174 – 3M	174	58
177 – 3M	177	59
180 – 3M*	180	60
186 – 3M*	186	62
192 – 3M*	192	64
201 – 3M	201	67
204 – 3M*	204	68
210 – 3M	210	70
213 – 3M	213	71
216 – 3M	216	72
225 – 3M	225	75
240 – 3M	240	80
246 – 3M*	246	82
252 – 3M	252	84
255 – 3M	255	85
267 – 3M	267	89
285 – 3M*	285	95
294 – 3M*	294	98
300 – 3M	300	100
312 – 3M	312	104
318 – 3M	318	106
336 – 3M	336	112
339 – 3M	339	113
363 – 3M	363	121
384 – 3M	384	128
390 – 3M	390	130
420 – 3M	420	140
447 – 3M	447	149
474 – 3M	474	158
480 – 3M	480	160
486 – 3M*	486	162
489 – 3M*	489	163
495 – 3M*	495	165
501 – 3M	501	167
513 – 3M	513	171
522 – 3M*	522	174
525 – 3M*	525	175

*Non-stock items, delivery on request.

Standard widths: 6, 9, 15 mm;
intermediate widths on request.

Tooth Profile HTD 3M

Standard lengths

Table 1

Designation	Pitch length L_w (mm)	No. of teeth z
537 – 3M	537	179
564 – 3M	564	188
570 – 3M	570	190
597 – 3M*	597	199
600 – 3M*	600	202
606 – 3M	606	202
612 – 3M*	612	204
633 – 3M	633	211
669 – 3M	669	223
708 – 3M	708	236
711 – 3M	711	237
738 – 3M*	738	246
753 – 3M*	753	251
822 – 3M	822	274
843 – 3M*	843	281
882 – 3M	882	294
945 – 3M	945	315
960 – 3M*	960	320
1041 – 3M	1041	347
1068 – 3M	1068	356
1071 – 3M	1071	357
1125 – 3M	1125	375
1176 – 3M*	1176	392
1245 – 3M	1245	415
1569 – 3M	1569	523

*Non-stock items, delivery on request.

Standard widths: 6, 9, 15 mm; intermediate widths on request.

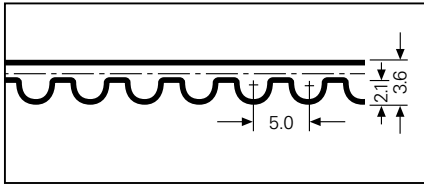

Tooth Profile HTD 5M

Standard lengths

Table 2

Designation	Pitch length L_w (mm)	No. of teeth z
225 – 5M*	225	45
265 – 5M*	265	53
275 – 5M	275	55
295 – 5M*	295	59
300 – 5M	300	60
330 – 5M	330	66
350 – 5M	350	70
375 – 5M	375	75
400 – 5M	400	80
425 – 5M	425	85
450 – 5M	450	90
460 – 5M	460	92
475 – 5M	475	95
500 – 5M	500	100
525 – 5M*	525	105
535 – 5M	535	107
550 – 5M	550	110
565 – 5M	565	113
600 – 5M	600	120
615 – 5M	615	123
620 – 5M	620	124
630 – 5M	630	126
635 – 5M	635	127
665 – 5M	665	133
700 – 5M	700	140
710 – 5M	710	142
740 – 5M	740	148
755 – 5M	755	151
800 – 5M	800	160
835 – 5M	835	167
890 – 5M	890	178
900 – 5M	900	180
925 – 5M	925	185
950 – 5M	950	190
1000 – 5M	1000	200
1050 – 5M	1050	210
1125 – 5M	1125	225
1200 – 5M	1200	240
1270 – 5M	1270	254
1420 – 5M	1420	284
1500 – 5M	1500	300
2000 – 5M	2000	400

*Non-stock items, delivery on request.

Standard widths: 9, 15, 25 mm; intermediate widths on request.

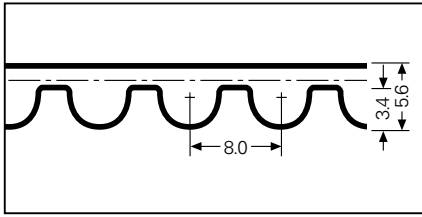

Tooth Profile HTD 8M

Standard lengths

Table 3

Designation	Pitch length L_w (mm)	No. of teeth z
288 – 8M	288	36
312 – 8M	312	44
376 – 8M	376	47
416 – 8M	416	52
424 – 8M	424	53
472 – 8M*	474	59
480 – 8M	480	60
560 – 8M	560	70
600 – 8M	600	75
624 – 8M*	624	78
640 – 8M	640	80
656 – 8M	656	82
720 – 8M	720	90
776 – 8M*	776	97
784 – 8M	784	98
800 – 8M	800	100
880 – 8M	880	110
912 – 8M*	912	114
920 – 8M	920	115
960 – 8M	960	120
1040 – 8M	1040	130
1120 – 8M	1120	140
1200 – 8M	1200	150
1280 – 8M	1280	160
1304 – 8M	1304	163
1328 – 8M*	1328	166
1360 – 8M	1360	170
1424 – 8M	1424	178
1440 – 8M	1440	180
1600 – 8M	1600	200
1760 – 8M	1760	220
1800 – 8M	1800	225
2000 – 8M	2000	250
2248 – 8M	2248	281
2400 – 8M	2400	300
2800 – 8M	2800	350
3008 – 8M	3008	367
3408 – 8M	3408	426
3808 – 8M	3808	477

*Non-stock items, delivery on request.

Standard widths: 20, 30, 50, 85 mm; intermediate widths on request.

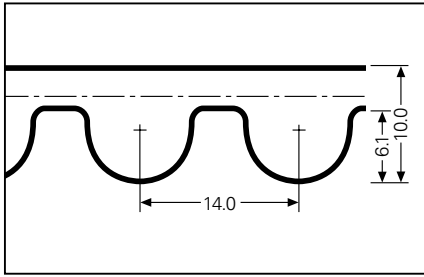

Tooth Profile HTD 14M

Standard lengths

Table 4

Designation	Pitch length L_w (mm)	No. of teeth z
966 – 14M	966	69
1190 – 14M	1190	85
1400 – 14M	1400	100
1610 – 14M	1610	115
1778 – 14M	1778	127
1890 – 14M	1890	135
2100 – 14M	2100	150
2310 – 14M	2310	165
2450 – 14M	2450	175
2590 – 14M	2590	185
2800 – 14M	2800	200
3150 – 14M	3150	225
3500 – 14M	3500	250
3850 – 14M	3850	275
4326 – 14M	4326	309
4578 – 14M	4578	327

Standard widths: 40, 55, 85, 115, 170 mm; intermediate widths on request.

Length Measurement

The pitch length is decisive for the calculation and application of CONTI SYNCHROBELT® HTD synchronous drive belts. A precise measurement can only be made on suitable measuring equipment.

The synchronous drive belt is placed over two equal size measuring pulleys with the same pitch diameters. The movable measuring pulley is loaded in such a way that the measuring force F will act on the synchronous drive belt. To ensure a correct position of the synchronous drive belt on the pulleys and a uniform tension on both belt sides, the synchronous drive belt must have completed at least 2 rotations under load. The centre distance " a " is then to be measured between the two pulleys.

The pitch length L_W is double the centre distance " a " plus the pitch circumference " U_W " of the synchronous drive belt test pulleys.

$$\begin{aligned} L_W &= 2 \cdot a + U_W \\ &= 2 \cdot a + \pi \cdot d_W \\ &= 2 \cdot a + z \cdot t \end{aligned}$$

The test measurement lay-out is shown in Fig. 1. The dimensions of the measuring pulleys and the measuring forces are indicated in table 6.

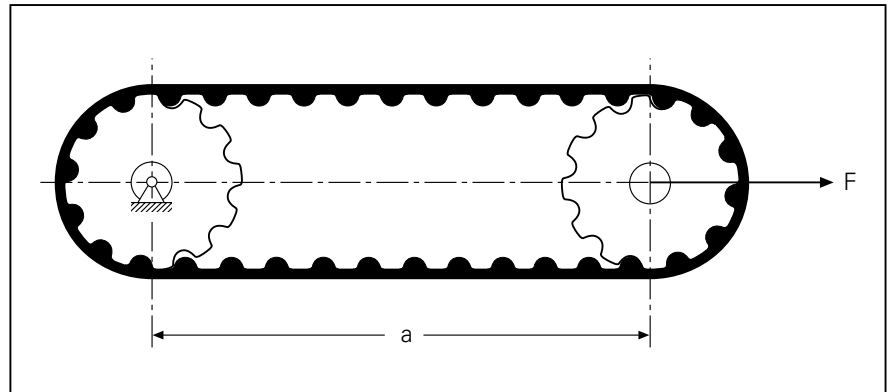

Measuring configuration

Fig. 1

Measuring Pulleys and Test Force

Table 5

Tooth profile		HTD 3M	HTD 5M	HTD 8M	HTD 14M
Tooth pitch t	mm	3	5	8	14
No. of teeth z	1	12	20	30	36
	2	20	48	48	–
	3	40	–	–	–
Pitch diameter d_w	mm				
	1	11.46	31.83	76.39	160.43
	2	19.10	76.39	122.23	–
Pitch circumference U_w	mm				
	1	36	100	240	504
	2	60	240	384	–
Outside diameter d_a	mm				
	1	10.70 ± 0.013	30.69 ± 0.013	75.02 ± 0.013	157.63 ± 0.025
	2	18.34 ± 0.013	75.25 ± 0.013	120.86 ± 0.013	–
Measuring force F for width b	N				
	6 mm	40	–	–	–
	9 mm	60	110	–	–
	15 mm	110	210	–	–
	20 mm	–	–	480	725*
	25 mm	–	340	–	–
	30 mm	–	–	*	–
	40 mm	–	–	–	*

*For synchronous drive belts with a larger width, length measurement is performed on narrower belts at a correspondingly reduced measuring force.

Tolerances

CONTI SYNCHROBELT® HTD synchronous drive belts are precision products. They are manufactured with maximum care and accuracy. The tolerances for length, width and thickness variations are extremely narrow.

Length Tolerances for Synchronous Drive Belts

Table 6

Pitch length L_W mm	Tolerance of centre distance deviation mm
≤ 150	± 0.15
$> 150 - 255$	± 0.20
$> 255 - 400$	± 0.23
$> 400 - 560$	± 0.25
$> 560 - 800$	± 0.30
$> 800 - 1000$	± 0.33
$> 1000 - 1270$	± 0.38
$> 1270 - 1500$	± 0.40
$> 1500 - 1800$	± 0.43
$> 1800 - 2000$	± 0.45
$> 2000 - 2250$	± 0.48
> 2250	The tolerance value increases by a further 0.05 mm per 500 mm increase in length.

For further information on length measurement, see page 15.

Width Tolerances for Synchronous Drive Belts

Table 7

Belt width b mm	Width tolerance for pitch length L_W mm		
	up to 880 mm	> 880 up to 1760 mm	> 1760 mm
≤ 9	+ 0.4 - 0.8	+ 0.4 - 0.8	
$> 9 - 40$	+ 0.8 - 0.8	+ 0.8 - 1.2	+ 0.8 - 1.2
$> 40 - 50$	+ 0.8 - 1.2	+ 1.2 - 1.2	+ 1.2 - 1.5
$> 50 - 85$	+ 1.2 - 1.2	+ 1.5 - 1.5	+ 1.5 - 2.0
$> 85 - 170$	+ 1.5 - 1.5	+ 1.5 - 2.0	+ 2.0 - 2.0
> 170		+ 4.8 - 4.8	+ 4.8 - 4.8

Thickness Tolerances for Synchronous Drive Belts

Table 8

Tooth profile		HTD 3M	HTD 5M	HTD 8M	HTD 14M
Belt thickness h_s	mm	2.4	3.6	5.6	10.0
Thickness tolerance					
Standard construction	mm	± 0.20	± 0.25	± 0.40	± 0.60
Special construction	mm	± 0.12	± 0.15	± 0.20	± 0.25

Material	Pulley Diameters
Flanged Pulleys	Tolerances
Designation	Balancing

HTD Toothed Pulleys



CONTI SYNCHROBELT® HTD synchronous drive belt on a machine tool.

HTD Toothed Pulleys

The function of a synchronous belt drive is essentially influenced by the quality of the pertaining toothed pulleys. They are precision components and produced with milling cutters accurately to pitch so that a precise meshing of teeth is obtained.

Toothed pulleys for SYNCHROBELT® HTD synchronous belt drives are manufactured to customers' specifications. ContiTech's application engineers can put you in touch with experienced manufacturers.

Material

The material selected depends on the size of the pulley and on the power to be transmitted.

– Plastic	PA6 and 6.6, POM for tooth pitches 3 and 5 mm
– Aluminium alloy	AlCuMgPb F 35 to F 38 for tooth pitches 3 and 5 mm, in hard anodised type possibly also for tooth pitch 8 mm
– Steel	9 SMn 28K, 9 SMnPb 28K, Ck45 for tooth pitches 5, 8 and 14 mm
– Grey cast iron	GG-22 to GG-25 for tooth pitches 8 and 14 mm

When placing orders without any particular specification, the respective material will be selected as dictated by practical experience.

Flanged Pulleys

Flanged pulleys prevent synchronous drive belts from tracking off. It is necessary to provide at least one toothed pulley with side flanges. This is normally the smaller toothed pulley for reasons of cost. It is also possible to incorporate a single sided flange on each pulley. In the case of drives with a centre distance of $a \geq 8 \cdot d_{wk}$, both toothed pulleys are required to be equipped with pulleys flanged on both sides.

Flanged pulleys are angled at the discretion of the pulley manufacturers and/or they are chamfered or radiused. They are generally screwed on for pulley diameters of > 250 mm. For diameters < 250 mm, flanged pulleys are screwed on as from pulley width of 85 mm; with all other pulleys, flanged pulleys are generally press-fit. For drives with a fixed centre distance, screwed-on flanged pulleys should be provided for ease of mounting.

The height of the flanged pulley shall at least be identical with the height of the synchronous drive belt running in the pulley. The tolerance for the outside diameter of the flanged pulley amounts to ± 1.0 mm.

The thickness of the flanged pulley is governed by the outside diameter of the toothed pulley.

Flanged Pulley Thickness s_b in mm

Table 9

Tooth profile		HTD 3M	HTD 5M	HTD 8M	HTD 14M
Toothed pulley- Outside diameter d_a	mm ≤ 100	1.0	1.0	1.5	–
	> 100 –250	1.5	1.5	1.5	2.0
	> 250	–	–	2.0	2.0

Designation

HTD toothed pulleys are designated as follows:

– P

General designation for toothed pulleys.

– No. of teeth

The number of teeth of the toothed pulley is calculated from the pitch circumference and the pitch:

$$z = \frac{U_w}{t} = \frac{\pi \cdot d_w}{t}$$

– Tooth pitch in mm

The tooth pitch of the pulley is the distance between two reference points on adjacent teeth at the pitch circumference. The pulley pitch diameter is larger than the outside diameter of the pulley by double the thickness at which the pitch line of belt rides above the pulley.

– Toothed pulley width in mm

The width designation defines the exact width of the pertaining synchronous drive belt, but not the exact pulley width. Tables 12 to 18 indicate the interrelationship of the synchronous drive belt and of the pulley width (pages 23 to 26).

– Flanged pulley data

F means pulleys flanged on both sides.

Example

HTD toothed pulley PT 40 – 8M – 50 F

PT _____ Designation for the toothed pulley with Taper Look bush

40 _____ 40 teeth

8M _____ 8 mm tooth pitch

50 _____ Toothed pulley designation for a 50 mm wide synchronous

F _____ Pulleys flanged on both sides

When placing orders, comprehensive data and instructions will help avoid misunderstandings and delay. The data given under "toothed pulley specification index" facilitates compilation of all values required. It furthermore contains instructions on which pages the exact data can be found.

Toothed Pulley Specification Index

Table 10

Parameter	Toothed Pulley 1	Toothed Pulley 2	Page reference pulley pitch			
			3M	5M	8M	14M
Tooth pitch t	mm		23	24	25	26
No. of teeth z			23	24	25	26
Pitch diameter d_w	mm		23	24	25	26
Outside diameter d_a	mm		23	24	25	26
Width designation	mm		23	24	25	26
Effective pulley width	mm		23	24	25	26
Flanged pulleys	on side/on both sides	on side/on both sides	20			
Flanged pulleys diameter d_b	mm		20			
Flanged pulleys thickness S_b	mm		20			
Type of mounting*	pressed/screwed on	pressed/screwed on	20			
Stock bore d_v	mm		23	24	25	26
Finished bore d_f	mm		23	24	25	26
Fit						
Keyway						
Material			20			
Special features**			31–32			

* Pressed = fixed, screwed = detachable, e.g. for fixed centre distance
 ** e.g. narrow Tolerances, balancing, clamping bushes, hub, surface treatment

Pulley Diameters

Tables 11 to 17 (pages 23 to 26) indicate preferred sizes for SYNCHROBELT® HTD toothed pulleys. Further sizes can be supplied for drives requiring toothed pulleys with different numbers of teeth. For these sizes, tables 19 to 22 (pages 27 to 30) contain data on the numbers of teeth and on the outside and pitch diameters. Further information about the flanged pulley diameter, stock bore and maximum finished bore on request.

HTD Toothed Pulleys

Tooth Pitch 3 mm – Preferred Sizes

(Dimensions in mm)

Table 11

No. of teeth z	Pitch-Ø d_w	Outside-Ø d_a	Flanged pulley-Ø d_b	Stock bore-Ø d_v	Finished bore-Ø $d_{F \max}$
10	9.55	8.79	13	3	3.5
12	11.46	10.70	15	3	5
14	13.37	12.61	16	3	6
15	14.32	13.56	17.5	3	7
16	15.28	14.52	18	4	5.5
17	16.23	15.47	20	4	6.5
18	17.19	16.43	19.5	6	6.5
19	18.14	17.38	21	6	8
20	19.10	18.34	23	6	8
21	20.05	19.29	25	6	9
22	21.01	20.25	25	6	9
24	22.92	22.16	25	6	9
26	24.83	24.07	28	6	10
28	26.74	25.98	32	6	11
30	28.65	27.89	32	6	12.5
32	30.56	29.80	36	6	13.5
34	32.47	31.71	36	6	15
36	34.38	33.62	38	6	15
38	36.29	35.53	42	6	15
40	38.20	37.44	42	6	16.5
44	42.02	41.26	48	6	20
50	47.75	46.99	–	8	20
56	53.48	52.72	–	8	20
64	61.12	60.36	–	8	20
72	68.75	67.99	–	8	20

Interrelation – Synchronous Drive Belt Width – Pulley Width for Standard Belt Widths

(Dimensions in mm)

Table 12

Synchronous drive belt width b	Toothed pulley; face width for flanged pulleys	
	with 2 flanges	without flanges
6	8	10
9	11	13
15	17	19

The toothed width of pulleys with flanges may vary slightly, as the thickness of the depends on the diameter of the pulley (Table 9, page 20).

HTD Toothed Pulleys
Tooth Pitch 5 mm – Preferred Sizes

(Dimensions in mm)

Table 13

No. of teeth z	Pitch-Ø d_w	Outside-Ø d_a	Flanged pulley-Ø d_b	Stock bore-Ø d_v	Finished bore-Ø $d_{F \max}$
12	19.10	17.96	23	4	8
14	22.28	21.14	26	4	9
15	23.87	22.73	28	6	10
16	25.46	24.32	30	4	10.5
18	28.65	27.51	33	6	12.5
20	31.83	30.69	36	6	13.5
21	33.42	32.28	38	6	14
22	35.01	33.87	40	6	15
24	38.20	37.06	42	6	16
26	41.38	40.24	45	8	18
28	44.56	43.42	48	8	30
30	47.75	46.60	51	6	18
32	50.93	49.79	55	8	23
36	57.30	56.16	61	8	23
40	63.66	62.52	67	8	23
44	70.03	68.89	–	8	23
48	76.39	75.25	–	8	38
60	95.49	94.35	–	10	28
72	114.59	113.45	–	10	28

Interrelation – Synchronous Drive Belt Width –
Pulley Width for Standard Belt Widths

(Dimensions in mm)

Table 14

Synchronous drive belt width b	Toothed pulley; face width for flanged pulleys	
	with 2 flanges	without flanges
9	11	14.5
15	17	20.5
25	27	30.0

The toothed width of pulleys with flanges may vary slightly, as the thickness of the depends on the diameter of the pulley (Table 9, page 20).

HTD Toothed Pulleys Tooth Pitch 8 mm – Preferred Sizes

(Dimensions in mm)

Table 15

No. of teeth z	Pitch- \emptyset d_w	Outside- \emptyset d_a	Flanged pulley- \emptyset d_b	Stock bore- \emptyset d_v	Finished bore- \emptyset $d_{F \max}$
22	56.02	54.65	60	12	25
24	61.12	59.75	66	12	28
26	66.21	64.85	70	12	30
28	71.30	70.08	75	15	30
30	76.39	75.13	82	15	32
32	81.49	80.16	87	15	35
34	86.58	85.22	91	15	42
36	91.67	90.30	97	15	42
38	96.77	95.39	102	15	45
40	101.86	100.49	106	15	45
44	12.05	110.67	120	15	45
48	122.23	120.86	128	15	45
56	142.60	141.23	150	15	50
64	162.97	161.60	168	15	50
72	183.35	181.97	192	15	55
80	203.72	202.35	–	15	60
90	229.18	227.81	–	15	60
112	285.21	283.83	–	18	60
144	366.69	365.32	–	20	60
168	427.81	426.44	–	20	60
192	488.92	487.55	–	20	60

Interrelation – Synchronous Drive Belt Width – Pulley Width for Standard Belt Widths

(Dimensions in mm)

Table 16

Synchronous drive belt width b	Toothed pulley; face width for flanged pulleys	
	with 2 flanges	without flanges
20	24	28
30	34	38
50	56	60
85	91	95

The toothed width of pulleys with flanges may vary slightly, as the thickness of the depends on the diameter of the pulley (Table 9, page 20).

HTD Toothed Pulleys
Tooth Pitch 14 mm – Preferred Sizes

(Dimensions in mm)

Table 17

No. of teeth z	Pitch-Ø d_w	Outside-Ø d_a	Flanged pulley-Ø d_b	Stock bore-Ø d_v	Finished bore-Ø $d_{F \max}$
28	124.78	121.98	130	24	60
29	129.23	126.43	134	24	60
30	133.69	130.89	138	24	60
32	142.60	139.80	148	24	60
34	151.52	148.72	156	24	60
36	160.43	157.63	166	24	60
38	169.34	166.54	183	24	70
40	178.25	175.45	184	24	70
44	196.08	193.28	202	24	70
48	213.90	211.10	220	24	75
56	249.55	246.75	254	28	75
64	285.21	282.41	290	28	75
72	320.86	318.06	–	28	75
80	356.51	353.71	–	28	75
90	401.07	398.27	–	28	75
112	499.11	496.31	–	28	75
144	641.71	638.91	–	28	75
168	748.66	745.86	–	28	75
192	855.62	852.82	–	28	75
216	962.57	959.76	–	28	85

Interrelation – Synchronous Drive Belt Width –
Pulley Width for Standard Belt Widths

(Dimensions in mm)

Tabelle 18

Synchronous drive belt width b	Toothed pulley; face width for flanged pulleys	
	with 2 flanges	without flanges
40	48	54
55	64	70
85	94	102
115	125	133
170	180	187

The toothed width of pulleys with flanges may vary slightly, as the thickness of the depends on the diameter of the pulley (Table 9, page 20).

HTD Toothed Pulleys
Tooth Pitch 3 mm

(Dimensions in mm)

Table 19

No. of teeth z	Pitch-Ø d _w	Out- side-Ø d _a	No. of teeth z	Pitch-Ø d _w	Out- side-Ø d _a	No. of teeth z	Pitch-Ø d _w	Out- side-Ø d _a	No. of teeth z	Pitch-Ø d _w	Out- side-Ø d _a
10	9.55	8.79	48	45.84	45.08	86	82.12	81.36	124	118.41	117.65
11	10.50	9.74	49	46.79	46.03	87	83.08	82.32	125	119.37	118.61
12	11.46	10.70	50	47.75	46.99	88	84.03	83.27	126	120.32	119.56
13	12.41	11.65	51	48.70	47.94	89	84.99	84.23	127	121.28	120.52
14	13.37	12.61	52	49.66	48.90	90	85.94	85.18	128	122.23	121.47
15	14.32	13.56	53	50.61	49.85	91	86.90	86.14	129	123.19	122.43
16	15.28	14.52	54	51.57	50.81	92	87.85	87.09	130	124.14	123.38
17	16.23	15.47	55	52.52	51.75	93	88.81	88.05	131	125.10	124.34
18	17.19	16.43	56	53.48	52.72	94	89.76	89.00	132	126.05	125.29
19	18.14	17.38	57	54.43	53.67	95	90.72	89.96	133	127.01	126.25
20	19.10	18.34	58	55.39	54.63	96	91.67	90.91	134	127.95	127.20
21	20.05	19.29	59	56.34	55.58	97	92.63	91.87	135	128.92	128.16
22	21.01	20.25	60	57.30	56.54	98	93.59	92.82	136	129.87	129.11
23	21.96	21.20	61	58.25	57.49	99	94.54	93.78	137	130.83	130.07
24	22.92	22.16	62	59.21	58.45	100	95.49	94.73	138	131.78	131.02
25	23.87	23.11	63	60.16	59.40	101	96.45	95.69	139	132.74	131.98
26	24.83	24.07	64	61.12	60.36	102	97.40	96.64	140	133.69	132.93
27	25.78	25.02	65	62.07	61.31	103	98.36	97.50	141	134.65	133.89
28	26.74	25.98	66	63.03	62.27	104	99.31	98.55	142	135.60	134.84
29	27.69	25.93	67	63.98	63.22	105	100.27	99.51	143	136.55	135.79
30	28.65	27.89	68	64.94	64.18	106	101.22	100.46	144	137.51	136.75
31	29.60	28.84	69	65.89	65.13	107	102.18	101.42	145	138.46	137.70
32	30.56	29.80	70	66.85	66.09	108	103.13	102.37	146	139.42	138.66
33	31.51	30.75	71	67.80	67.04	109	104.09	103.33	147	140.37	139.61
34	32.47	31.71	72	68.75	67.99	110	105.04	104.28	148	141.33	140.57
35	33.42	32.66	73	69.71	68.95	111	106.00	105.24	149	142.28	141.52
36	34.38	33.62	74	70.66	69.90	112	106.95	106.19	150	143.24	142.48
37	35.33	34.57	75	71.62	70.86	113	107.91	107.15	151	144.19	143.43
38	36.29	35.53	76	72.57	71.81	114	108.86	108.10	152	145.15	144.39
39	37.24	36.48	77	73.53	72.77	115	109.82	109.05	153	146.10	145.34
40	38.20	37.44	78	74.48	73.72	115	110.77	110.01	154	147.06	146.30
41	39.15	38.39	79	75.44	74.68	117	111.73	110.97	155	148.01	147.25
42	40.11	39.35	80	76.39	75.63	118	112.68	111.92	156	148.97	148.21
43	41.06	40.30	81	77.35	76.59	119	113.64	112.88	157	149.92	149.16
44	42.02	41.26	92	78.30	77.54	120	114.59	113.83	158	150.88	150.12
45	42.97	42.21	83	79.26	78.50	121	115.55	114.79	159	151.83	151.07
46	43.93	43.17	84	80.21	79.45	122	116.50	115.74	160	152.79	152.03
47	44.88	44.12	85	81.17	80.41	123	117.46	116.70			

HTD Toothed Pulleys
Tooth Pitch 5 mm

(Dimensions in mm)

Table 20

No. of teeth z	Pitch-Ø d _w	Out- side-Ø d _a	No. of teeth z	Pitch-Ø d _w	Out- side-Ø d _a	No. of teeth z	Pitch-Ø d _w	Out- side-Ø d _a	No. of teeth z	Pitch-Ø d _w	Out- side-Ø d _a
14	22.28	21.14	51	81.17	80.03	88	140.06	138.92	125	198.94	197.80
15	23.87	22.73	52	82.76	81.62	89	141.65	140.51	126	200.54	199.40
16	25.46	24.32	53	84.35	83.21	90	143.24	142.10	127	202.13	200.99
17	27.06	25.92	54	85.94	84.80	91	144.83	143.69	128	203.72	202.58
18	28.65	27.51	55	87.54	86.40	92	146.42	145.28	129	205.31	204.17
19	30.24	29.10	56	89.13	87.99	93	148.01	146.87	130	206.90	205.76
20	31.83	30.69	57	90.72	89.58	94	149.61	148.47	131	208.49	207.35
21	33.42	32.28	58	92.31	91.17	95	151.20	150.06	132	210.08	208.94
22	35.01	33.87	59	93.90	92.76	96	152.79	151.65	133	211.68	210.54
23	36.61	35.47	60	95.49	94.35	97	154.38	153.24	134	213.27	212.13
24	38.20	37.06	61	97.08	95.94	98	155.97	154.83	135	214.86	213.72
25	39.79	38.65	62	98.68	97.54	99	157.56	156.42	136	216.45	215.31
26	41.38	40.24	63	100.27	99.13	100	159.15	158.01	137	218.04	216.90
27	42.97	41.83	64	101.86	100.72	101	160.75	159.61	138	219.63	218.49
28	44.56	43.42	65	103.45	102.31	102	162.34	161.20	139	221.23	220.09
29	46.15	45.01	66	105.04	103.90	103	163.93	162.79	140	222.82	221.68
30	47.75	46.61	67	106.63	105.49	104	165.52	164.30	141	224.41	223.27
31	49.34	48.20	68	108.23	107.05	105	167.11	165.97	142	226.00	224.86
32	50.93	49.79	69	109.82	108.68	106	168.70	167.56	143	227.59	226.45
33	52.52	51.38	70	111.41	110.27	107	170.30	169.15	144	229.18	228.04
34	54.11	52.97	71	113.00	111.86	108	171.89	170.75	145	230.77	229.63
35	55.70	54.55	72	114.59	113.45	109	173.48	172.34	146	232.37	231.23
36	57.30	56.16	73	116.18	115.04	110	175.07	173.93	147	233.96	232.82
37	58.89	57.75	74	117.77	116.63	111	176.66	175.52	148	235.55	234.41
38	60.48	59.34	75	119.37	118.23	112	178.25	177.11	149	237.14	236.00
39	62.07	60.93	76	120.96	119.82	113	179.85	178.71	150	238.73	237.59
40	63.66	62.52	77	122.55	121.41	114	181.44	180.30	151	240.32	239.18
41	65.25	64.11	78	124.14	123.00	115	183.03	181.89	152	241.92	240.78
42	66.85	65.71	79	125.73	124.59	116	184.62	183.48	153	243.51	242.37
43	68.44	67.30	80	127.32	126.18	117	186.21	185.07	154	245.10	243.96
44	70.03	68.89	81	128.92	127.78	118	187.80	186.66	155	246.69	245.55
45	71.62	70.48	82	130.51	129.37	119	189.39	188.25	156	248.28	247.14
46	73.21	72.07	83	132.10	130.96	120	190.99	189.85	157	249.87	248.73
47	74.80	73.66	84	133.69	132.55	121	192.58	191.44	158	251.46	250.32
48	76.39	75.25	85	135.28	134.14	122	194.17	193.03	159	253.06	251.92
49	77.99	76.85	86	136.87	135.73	123	195.76	194.62	160	254.65	253.51
50	79.58	78.44	87	138.46	137.32	124	197.35	195.21			

HTD Toothed Pulleys
Tooth Pitch 8 mm

(Dimensions in mm)

Table 21

No. of teeth z	Pitch-Ø d _w	Out- side-Ø d _a	No. of teeth z	Pitch-Ø d _w	Out- side-Ø d _a	No. of teeth z	Pitch-Ø d _w	Out- side-Ø d _a	No. of teeth z	Pitch-Ø d _w	Out- side-Ø d _a
22	56.02	54.65	65	165.52	164.15	108	275.02	273.65	151	384.52	383.15
23	58.57	57.20	66	168.07	166.70	109	277.57	276.20	152	387.06	385.69
24	61.12	59.75	67	170.61	169.24	110	280.11	278.74	153	389.61	388.24
25	63.66	62.29	68	173.16	171.79	111	282.66	281.29	154	392.16	390.79
26	66.21	64.84	69	175.71	174.34	112	285.21	283.84	155	394.70	393.33
27	68.75	67.38	70	178.25	176.88	113	287.75	286.38	156	397.25	395.88
28	71.30	69.93	71	180.80	179.43	114	290.30	288.93	157	399.80	398.43
29	73.85	72.48	72	183.35	181.98	115	292.84	291.47	158	402.34	400.97
30	76.39	75.02	73	185.89	184.52	116	295.39	294.02	159	404.89	403.52
31	78.94	77.57	74	188.44	187.07	117	297.94	296.57	160	407.44	406.07
32	81.49	80.12	75	190.99	189.62	118	300.48	299.11	161	409.98	408.61
33	84.03	82.66	76	193.53	192.16	119	303.03	301.66	162	412.53	411.16
34	86.58	85.21	77	196.08	194.71	120	305.58	304.21	163	415.08	413.71
35	89.13	87.76	78	198.63	197.26	121	308.12	306.75	164	417.62	416.25
36	91.67	90.30	79	201.17	199.80	122	310.67	309.30	165	420.17	418.80
37	94.22	92.85	80	203.72	202.35	123	313.22	311.85	166	422.72	421.35
38	96.77	95.40	81	206.26	204.89	124	315.76	314.39	167	425.26	423.89
39	99.31	97.94	82	208.81	207.44	125	318.31	316.94	168	427.81	426.44
40	101.86	100.49	83	211.36	209.99	126	320.86	319.49	169	430.35	428.98
41	104.41	103.04	84	213.90	212.53	127	323.40	322.03	170	432.90	431.53
42	106.95	105.58	85	216.45	215.08	128	325.95	324.58	171	435.45	434.08
43	109.50	108.13	86	219.00	217.63	129	328.50	327.13	172	437.99	436.62
44	112.05	110.68	87	221.54	220.17	130	331.04	329.67	173	440.54	439.17
45	114.59	113.22	88	224.09	222.72	131	333.59	332.22	174	443.09	441.72
46	117.14	115.77	89	226.64	225.27	132	336.14	334.76	175	445.63	444.26
47	119.68	118.31	90	229.18	227.81	133	338.68	337.31	176	448.18	446.81
48	122.23	120.86	91	231.73	230.36	134	341.23	339.86	177	450.73	449.36
49	124.78	123.41	92	234.28	232.91	135	343.77	342.40	178	453.27	451.90
50	127.32	125.95	93	236.82	235.45	136	346.32	344.95	179	455.82	454.45
51	129.87	128.50	94	239.37	238.00	137	348.87	347.50	180	458.37	457.00
52	132.42	131.05	95	241.92	240.55	138	351.41	350.04	181	460.91	459.54
53	134.96	133.59	96	244.46	243.09	139	353.96	352.58	182	463.46	462.09
54	137.51	136.14	97	247.01	245.64	140	356.51	355.14	183	466.01	464.64
55	140.06	138.69	98	249.55	248.18	141	359.05	357.68	184	468.55	467.18
56	142.60	141.23	99	252.10	250.73	142	361.60	360.23	185	471.10	469.73
57	145.15	143.78	100	254.65	253.28	143	364.15	362.78	186	473.65	472.27
58	147.70	146.33	101	257.19	255.82	144	366.69	365.32	187	475.19	474.82
59	150.24	148.87	102	259.74	258.37	145	369.24	367.87	188	478.74	477.37
60	152.79	151.42	103	262.29	260.92	146	371.79	370.42	189	481.28	479.91
61	155.34	153.97	104	264.83	263.46	147	374.33	372.96	190	483.83	482.46
62	157.88	156.51	105	267.38	266.01	148	376.88	375.51	191	486.38	485.01
63	160.43	159.06	106	269.93	268.56	149	379.43	378.06	192	488.92	487.55
64	162.97	161.60	107	272.47	271.10	150	381.97	380.60			

HTD Toothed Pulleys
Tooth Pitch 14 mm

(Dimensions in mm)

Table 22

No. of teeth z	Pitch-Ø d _w	Out- side-Ø d _a	No. of teeth z	Pitch-Ø d _w	Out- side-Ø d _a	No. of teeth z	Pitch-Ø d _w	Out- side-Ø d _a	No. of teeth z	Pitch-Ø d _w	Out- side-Ø d _a
28	124.78	121.98	70	311.94	309.14	112	499.11	496.31	154	685.28	683.48
29	129.23	126.43	71	316.40	313.60	113	503.57	500.77	155	690.73	687.93
30	133.69	130.89	72	320.86	318.06	114	508.02	505.22	156	695.19	692.39
31	138.15	135.35	73	325.31	322.51	115	512.48	509.68	157	699.65	696.84
32	142.50	139.80	74	329.77	326.97	116	516.94	514.14	158	704.10	701.30
33	147.06	144.26	75	334.23	331.43	117	521.39	518.59	159	708.56	705.76
34	151.52	148.72	76	338.68	335.88	118	525.85	523.05	160	713.01	710.21
35	155.97	153.17	77	343.14	340.34	119	530.30	527.50	161	717.47	714.67
36	160.43	157.63	78	347.59	344.79	120	534.76	531.96	152	721.93	719.13
37	164.88	162.08	79	352.05	349.25	121	539.22	536.42	163	726.38	723.58
38	169.34	166.54	80	356.51	353.71	122	543.67	540.87	164	730.84	728.04
39	173.80	171.00	81	360.96	358.16	123	548.13	545.33	165	735.30	732.50
40	178.25	175.45	82	365.42	362.62	124	552.59	549.79	166	739.75	736.95
41	182.71	179.91	83	369.88	367.08	125	557.04	554.24	167	744.21	741.41
42	187.17	184.37	84	374.33	371.53	126	561.50	558.70	168	748.66	745.86
43	191.62	188.82	85	378.79	375.99	127	565.95	563.15	169	753.12	750.32
44	196.08	193.28	86	383.24	380.44	128	570.41	567.51	170	757.58	754.78
45	200.54	197.74	87	387.70	384.90	129	574.87	572.07	171	762.03	759.23
46	204.99	202.19	88	392.16	389.36	130	579.32	576.52	172	756.49	763.69
47	209.45	206.65	89	396.51	393.81	131	583.78	580.98	173	770.95	768.15
48	213.90	211.10	90	401.07	398.27	132	588.24	585.44	174	775.40	772.60
49	218.36	215.56	91	405.53	402.73	133	592.69	589.89	175	779.86	777.05
50	222.82	220.02	92	409.98	407.18	134	597.15	594.35	176	784.32	781.52
51	227.27	224.47	93	414.44	411.64	135	601.61	598.81	177	788.77	785.97
52	231.73	228.93	94	418.90	416.10	136	606.06	603.26	178	793.23	790.43
53	236.19	233.39	95	423.35	420.55	137	610.52	607.72	179	797.68	794.88
54	240.64	237.84	96	427.81	425.01	138	614.97	612.17	180	802.14	799.34
55	245.10	242.30	97	432.26	429.46	139	619.43	616.63	181	806.60	803.80
56	249.55	246.75	98	436.72	433.92	140	623.89	621.09	182	811.05	808.25
57	254.01	251.21	99	441.18	438.38	141	628.34	625.54	183	815.51	812.71
58	258.47	255.67	100	445.63	442.83	142	632.80	630.00	184	819.97	817.17
59	262.92	260.12	101	450.09	447.29	143	637.26	634.46	185	824.42	821.62
60	267.38	264.58	102	454.55	451.75	144	641.71	638.91	186	828.88	826.08
61	271.84	269.04	103	459.00	456.20	145	646.17	643.37	187	833.33	830.53
62	276.29	273.49	104	463.46	460.66	146	650.63	647.83	188	837.79	834.99
63	280.75	277.95	105	467.92	465.12	147	655.08	652.28	189	342.25	839.45
64	285.21	282.41	106	472.37	469.57	148	659.54	656.74	190	846.70	843.90
65	289.66	286.86	107	476.83	474.03	149	663.99	661.19	191	851.16	848.36
66	294.12	291.32	108	481.28	478.48	150	668.45	665.65	192	855.62	852.82
67	298.57	295.77	109	485.74	492.94	151	672.91	570.11			
68	303.03	300.23	110	490.20	487.40	152	677.36	674.56			
69	307.49	304.69	111	494.65	491.85	153	681.82	679.02			

Tolerances

Outside Diameter, Axial and Radial Runout

Tables 23 to 25 feature the tolerances for outside diameter, axial and radial runout.

Outside Diameter Tolerance

Table 23

Outside diameter d_a mm	Tolerance mm
≤ 25	+ 0.05 0
> 25 – 50	+ 0.08 0
> 50 – 100	+ 0.10 0
> 100 – 175	+ 0.13 0
> 175 – 300	+ 0.15 0
> 300 – 500	+ 0.18 0
> 500	+ 0.20 0

Axial Runout Tolerance

Table 24

Outside diameter d_a mm	Tolerance mm
≤ 100	0.1
> 100 – 250	0.001 per mm outside diameter
> 250	0.25 + 0.0005 per mm outside diameter

Radial Runout Tolerance

Table 25

Outside diameter d_a mm	Tolerance mm
≤ 200	0.13
> 200	0.13 + 0.0005 per mm outside diameter

Parallelism

Parallelism between the bore and teeth may not exceed the maximum deviation of 1 μm per millimeter of toothed pulley width.

Taper

The taper may amount to a maximum of 1 μm per millimeter over the width of the tooth and, at the same time, must not exceed the permissible diameter tolerance.

Balancing

With toothed pulleys machined on all sides, balancing is normally not necessary up to a circumferential speed of 30 m/s. Cast iron pulleys, however, must also be balanced at $v < 30$ m/s.

In general, there applies the following:

- Static balancing quality level Q 16 as per VDI 2060
 - at $v = 30$ m/s for $d_w > 400$ mm or
 - at $n = 1500$ min⁻¹ for $d_w \leq 400$ mm.
- Dynamic balancing as per recommended practice Q 6.3
 - at $v > 30$ m/s or
 - at $v > 20$ m/s at a pitch diameter to toothed pulley width ratio of < 4 .

Balancing takes place with non-keyed toothed pulleys on a smooth balancing mandrel.

For further details, see ISO 254 and VDI Recommendation 2060.

Balancing is performed on special request only.

Symbols, Units, Terms

Power Ratings

Design Data

Centre Distance Factors

Calculation Example

ContiTech Drive Design Service

Design of Synchronous Belt Drives

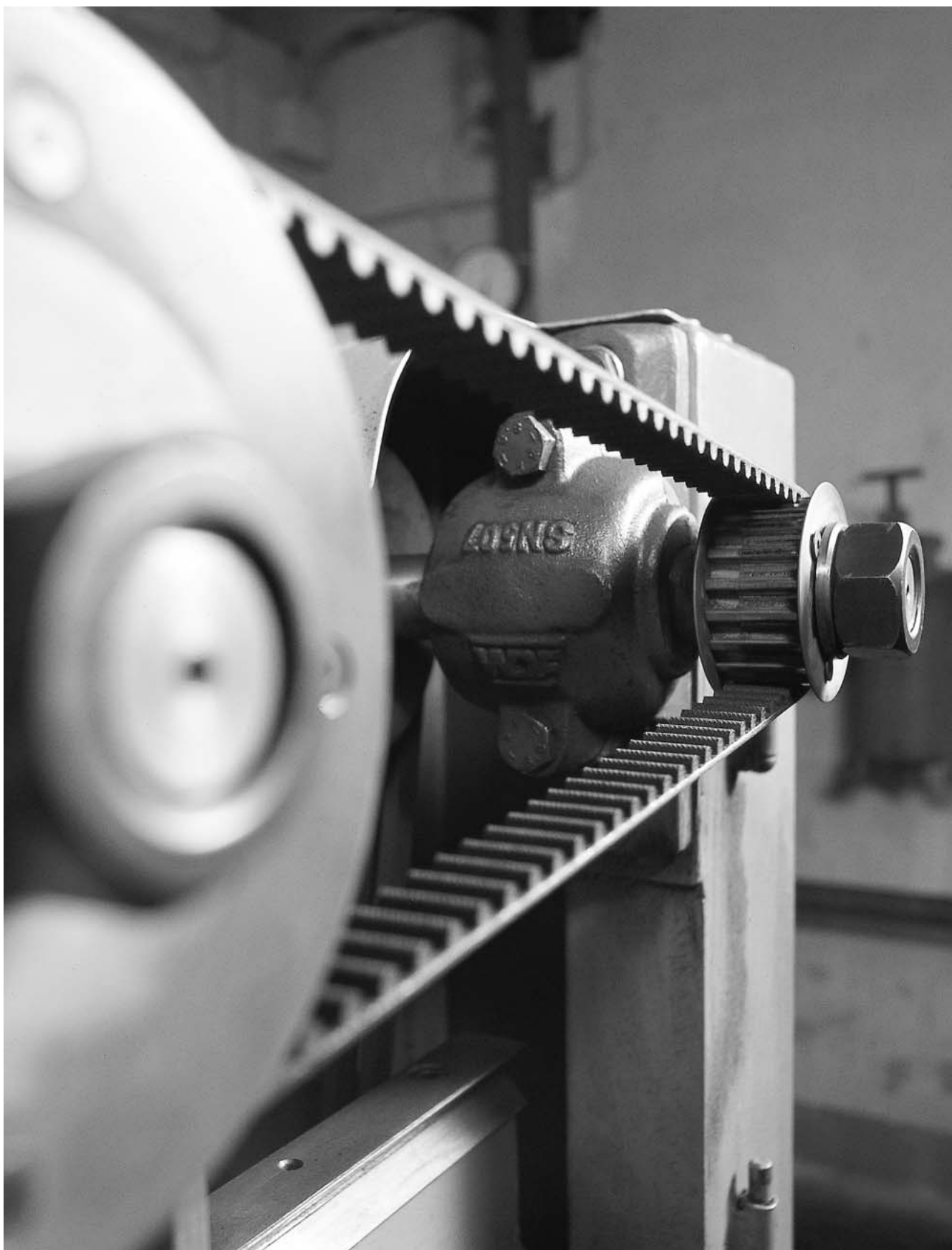

CONTI SYNCHROBELT® HTD synchronous drive belt being fatigue and performance-tested

Design of Synchronous Belt Drives

The following drive design is based upon drives equipped with CONTI SYNCHROBELT® HTD synchronous drive belts 3M, 5M, 8M and 14M.

In the event of particularly critical drive problems and multi-pulley applications, we recommend to contact ContiTech's application engineers for a noncommittal consultation.

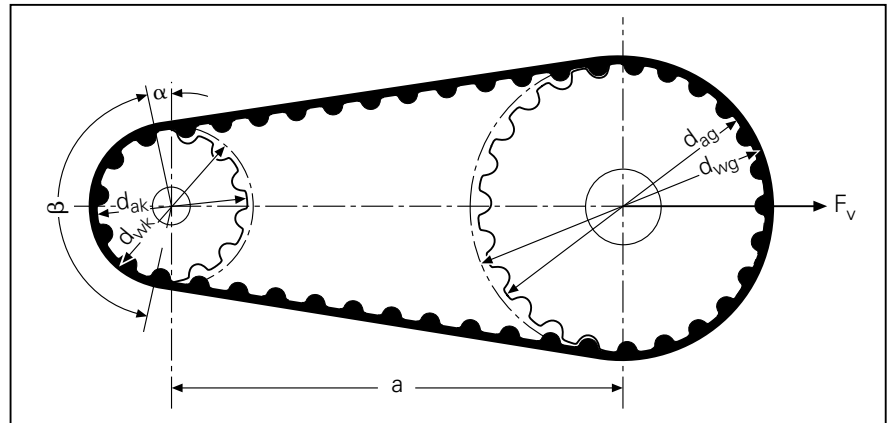

Symbols, Units, Terms

Symbol	Unit	Term
a	mm	Centre distance
b	mm	Width of synchronous drive belt
c_0		Overall service factor
c_1		Teeth in mesh factor
c_2		Load factor
c_3		Acceleration factor
c_4		Fatigue factor
c_5		Length factor
d_a	mm	Outside diameter of toothed pulley
d_{ag}	mm	Outside diameter of large toothed pulley
d_{ak}	mm	Outside diameter of small toothed pulley
d_w	mm	Pitch diameter of toothed pulley
d_{w1}	mm	Pitch diameter of driving toothed pulley
d_{w2}	mm	Pitch diameter of driven toothed pulley
d_{wg}	mm	Pitch diameter of large toothed pulley
d_{wk}	mm	Pitch diameter of small toothed pulley
f	Hz	Natural frequency
F_e	N	Test force
F_{stat}	N	Static belt tension
F_v	N	Overall preload
i		Speed ratio
L_w	mm	Pitch length of synchronous drive belt
n_1	min ⁻¹	Speed of driving toothed pulley
n_2	min ⁻¹	Speed of driven toothed pulley
n_g	min ⁻¹	Speed of large toothed pulley
n_k	min ⁻¹	Speed of small toothed pulley
P	kW	Power to be transmitted
P_R	kW	Power rating for standard belt width

Symbol	Unit	Term
t	mm	Tooth pitch
v	m/s	Belt speed
z	mm	No. of teeth of the synchronous drive belt
z ₁	mm	No. of teeth of driving toothed pulley
z ₂	mm	No. of teeth of driven toothed pulley
z _g	mm	No. of teeth of large toothed pulley
z _k	mm	No. of teeth of small toothed pulley
α	° (degree)	Belt side inclination angle $\alpha = 90 - \frac{\beta}{2}$
β	° (degree)	Wrap angle on the small toothed pulley

Design Data

The design data contains all data, formulae and tables required for the calculation of CONTI SYNCHROBELT® HTD synchronous belt drives. Omitted from the tables are values which can be easily calculated with the aid of the formulae specified.

Overall Service Factor c₀

The overall service factor c₀ takes into consideration safety factors for special operating conditions caused by loading conditions, acceleration and fatigue. It is calculated on the basis of the following factors:

$$c_0 = c_2 + c_3 + c_4$$

Teeth in Mesh Factor c₁

The teeth in mesh factor c₁ considers the number of teeth z_e of the small toothed pulley z_k meshing with the teeth of the synchronous drive belt.

$$z_e = z_k \cdot \frac{\beta}{360}$$

The calculation of the wrap angle β is illustrated on page 40.

The values for z_e < 6 are indicated in the table.

Table 26

No. of meshing teeth z _e	Teeth in mesh factor c ₁
3	0.4
4	0.6
5	0.8
≧ 6	1.0

Load Factor c_2

The load factor c_2 considers the type of the prime mover and of the driven machine. Particular conditions of operation are not considered in these values. The factors indicated are reference values.

Load Factor c_2

Table 27

Driven machines		Prime Movers		
		Electric motors with a slow starting torque (up to 1.5 times the rated torque) Water and steam turbines Internal combustion - engines with 8 and more cylinders	Electric motors with a medium starting torque (1.5 to 2.5 times the rated torque) Internal combustion engines with 4 to 6 cylinders	Electric motors with a high starting torque and braking torque (more than 2.5 times the rated torque) Internal combustion engines up to 4 cylinders
Office machines	Typewriters	1.0	1.1	1.2
	Printers, scanners, teleprinters, photocopiers	1.1	1.2	1.3
Small machines	Motion-picture projectors and cameras	1.0	1.1	1.2
Domestic machines	Centrifuges	1.0	1.1	1.2
	Kitchen machines, universal cutters	1.1	1.2	1.3
Sewing machines	Domestic sewing machines	1.1	1.2	1.3
	Industrial sewing machines	1.2	1.3	1.4
Laundry machines	Driers	1.2	1.4	1.6
	Washing machines	1.4	1.6	1.8
Conveyor Systems	Belt conveyors for light material	1.1	1.2	1.3
	Belt conveyors for ore, coal, sand	1.2	1.4	1.6
- for heavy materials	Elevators, screw conveyors, bucket-type elev.	1.4	1.6	1.8
Stirrers	Mixers, liquid	1.2	1.4	1.6
	semiliquid	1.3	1.5	1.7
Bakery machines	Bakery and dough-working machines	1.4	1.6	1.8
Machine tools	Lathes	1.2	1.4	1.6
	Machines for drilling, grinding, milling, planning	1.3	1.5	1.7
Wood working-machines	Wood turning lathes and band saws	1.2	1.3	1.5
	Planning machines and circular saws	1.2	1.4	1.6
	Sawing-mill machines	1.4	1.6	1.8
Brickworks machinery	Milling machines	1.4	1.6	1.8
	Loam mills	1.6	1.8	2.0
Textile machinery	Bobbin winding and warping machines	1.2	1.4	1.6
	Machines for spinning, twisting and weaving	1.3	1.5	1.7
Paper making machines	Agitators, calenders, drying machines	1.2	1.4	1.6
	Pumps, beating machines, stuff grinders	1.4	1.6	1.8
Printing machines	Cutting, slitting and folding machines	1.2	1.4	1.6
	Rotary presses	1.3	1.5	1.7
Screen machines	Drum screens	1.2	1.4	1.6
	Vibration screens	1.3	1.5	1.7
Fans, blowers	Exhausters, radial blowers	1.4	1.6	1.8
	Pit ventilators, axial blowers	1.6	1.8	2.0
Compressors	Helical compressors	1.4	1.5	1.6
	Piston compressors	1.6	1.8	2.0
Pumps	Centrifugal and gear pumps	1.2	1.4	1.6
	Reciprocating pumps	1.7	1.9	2.1
Generators	Generators and exiter	1.4	1.6	1.8
Elevators	Elevators and hoists	1.4	1.6	1.8
Centrifuges		1.5	1.7	1.9
Processing machines	Rubber processing machines	1.5	1.7	1.9
Mills	Hammer mills	1.5	1.7	1.9
	Ball, roller and gravel mills	1.7	1.9	2.1

Acceleration Factor c_3

The acceleration factor c_3 is to be applied when the step-up transmission ratio is > 1.24 .

Table 28

Transmission ratio $\frac{1}{i}$	Acceleration factor c_3
1.00 – 1.24	–
1.25 – 1.74	0.1
1.75 – 2.49	0.2
2.50 – 3.49	0.3
≥ 3.50	0.4

Fatigue Factor c_4

The fatigue factor c_4 takes into consideration the daily period of operation and the particular operating conditions.

Table 29

Type and period of operation	Fatigue factor c_4
Daily period of operation 10–16 hours	+ 0.2
Daily period of operation over 16 hours	+ 0.4
Additional belt deflection, e.g. by means of tensioning rolls	+ 0.2
Intermittend operation	– 0.2

Length Factor c_5

The length factor c_5 takes into consideration the belt flexing frequency as a function of the synchronous drive belt pitch length L_W .

Length Factor c_5

Table 30

CONTI SYNCHROBELT® HTD Synchronous Drive Belt							
3M	Pitch length L_W mm	< 191	191 to 260	261 to 400	401 to 600	> 600	
	c_5	0.8	0.9	1.0	1.1	1.2	
5M	Pitch length L_W mm	< 441	441 to 500	501 to 800	801 to 1100	> 1100	
	c_5	0.8	0.9	1.0	1.1	1.2	
8M	Pitch length L_W mm	< 640	640 to 959	960 to 1279	1280 to 1799	> 1799	
	c_5	0.8	0.9	1.0	1.1	1.2	
14M	Pitch length L_W mm	< 1400	1400 to 1777	1778 to 2099	2100 to 2589	2590 to 3499	> 3499
	c_5	0.8	0.9	0.95	1.0	1.05	1.1

Selection of the Synchronous Drive Belt Pitch

The diagrams of Figs. 2 and 3 render possible selection of the suitable synchronous drive belt pitch in accordance with the power to be transmitted by the synchronous belt drive, corrected by the overall service factor c_0 and by the speed of the small toothed pulley.

CONTI SYNCHROBELT® HTD Synchronous Drive Belt 3M, 5M

Fig. 2

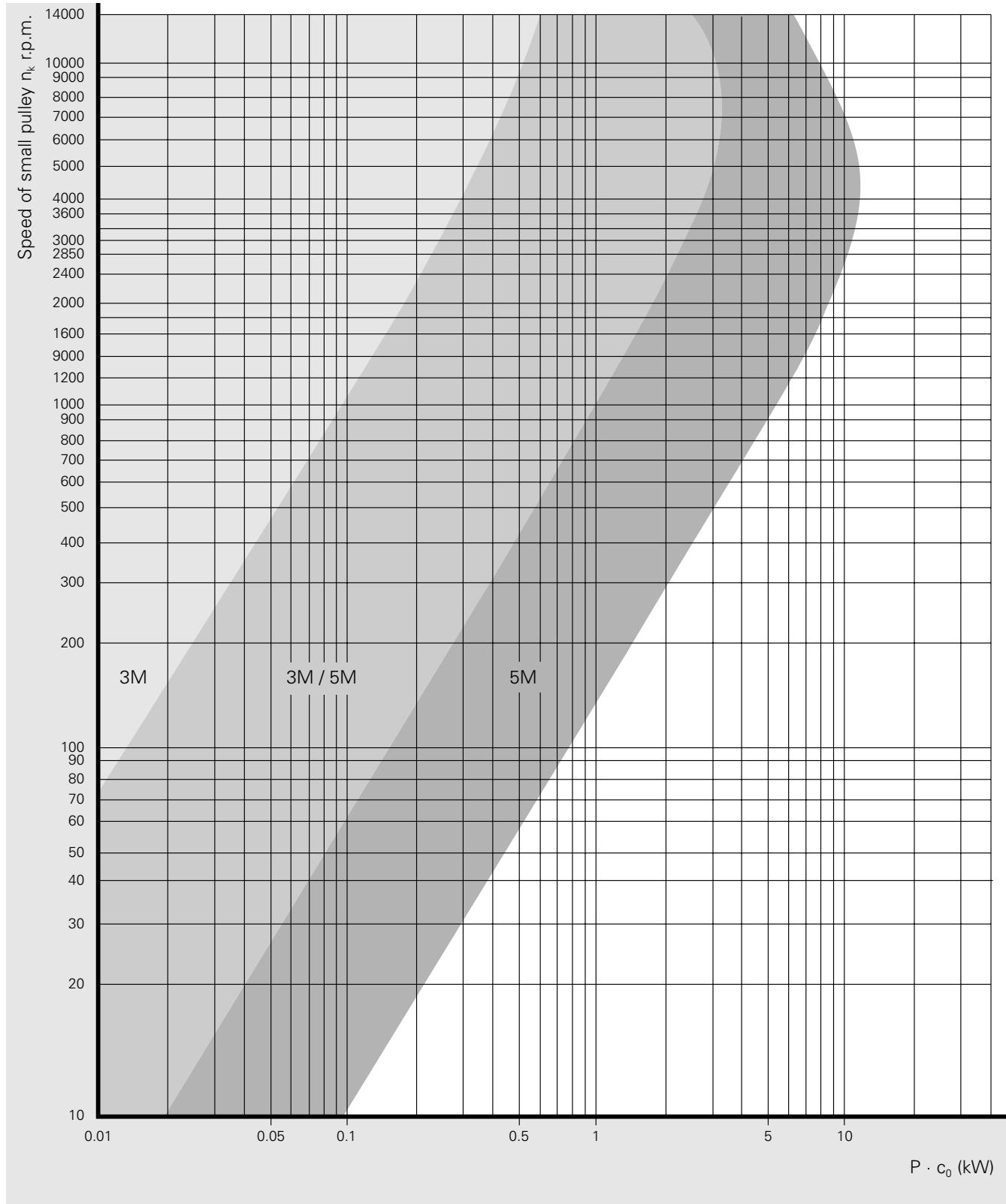

Where the table offers two pitch alternatives, it is recommended to calculate the drive in connection with both pitches.

An optimum utilization of power is obtained by the selection of pulley diameters being as large as possible.

CONTI SYNCHROBELT® HTD Synchronous Drive Belt 8M, 14M

Fig. 3

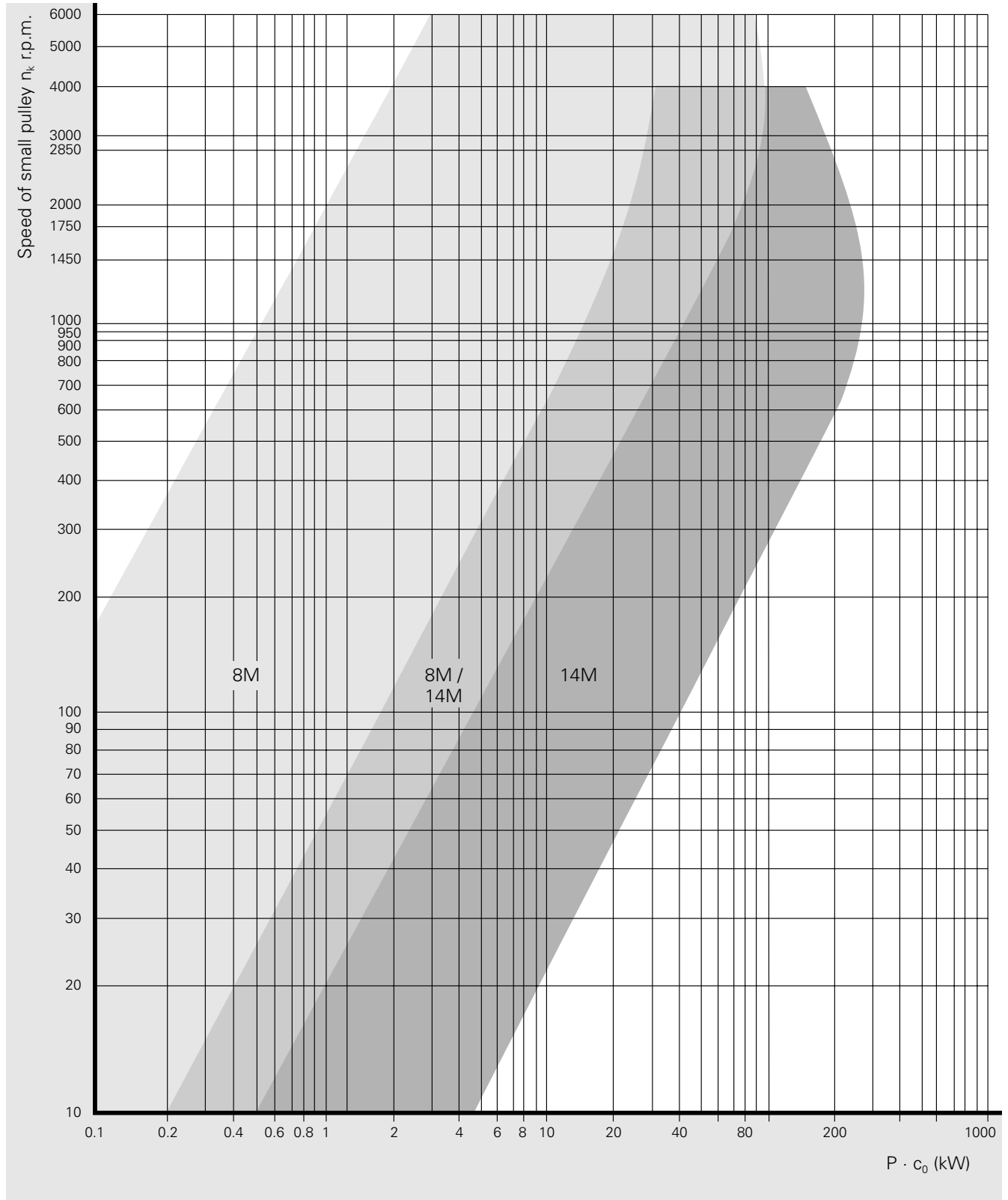

Permissible effective pull $F_{u\ zul}$

The permissible effective pull $F_{u\ zul}$ in N is shown in Table 31.

Permissible effective pull in N

Table 31

Belt width mm	Tooth profile			
	3M	5M	8M	14M
6	50			
9	80	120		
15	145	230		
20			550	
25		410		
30			870	
40				1700
50			1500	
55				2600
85			3200	4200
115				6100
170				11000

Transmission Ratio i

The transmission ratio i results from the ratio of the toothed pulley speeds n_1 and n_2 and/or of the number of teeth z_2 and z_1 or the pitch diameters of the toothed pulley d_{w2} and d_{w1} :

$$i = \frac{n_1}{n_2} = \frac{z_2}{z_1} = \frac{d_{w2}}{d_{w1}}$$

No. of teeth and Pitch Diameter d_w of the Toothed Pulleys

The number of teeth z and the pitch diameter d_w of the toothed pulleys are determined by means of pitch t of the tooth profile selected:

$$z_g = \frac{\pi \cdot d_{wg}}{t} \qquad d_{wg} = \frac{z_g \cdot t}{\pi} \text{ mm}$$

$$z_k = \frac{\pi \cdot d_{wk}}{t} \qquad d_{wk} = \frac{z_k \cdot t}{\pi} \text{ mm}$$

The number of teeth, pitch diameter and outside diameter for toothed pulleys are indicated in the tables 11 to 22 (pages 23 to 30).

Wrap Angle β

This is the angle of contact around the small pulley:

$$\beta = 2 \cdot \arccos \left[\frac{t \cdot (z_g - z_k)}{2 \cdot \pi \cdot a} \right] \text{ }^\circ(\text{degree})$$

Centre Distance a

The centre distance a is calculated on the basis of the following approximation:

$$a \approx \frac{1}{4} \cdot \left[L_w - \frac{t}{2} \cdot (z_g + z_k) + \sqrt{\left[L_w - \frac{t}{2} \cdot (z_g + z_k) \right]^2 - 2 \cdot \left[\frac{t}{\pi} \cdot (z_g - z_k) \right]^2} \right] \text{ mm}$$

The following guidelines apply to the determination of the centre distance for new and/or revised designs.

$$0.2 \cdot t \cdot (z_g + z_k) \leq a \leq 0.7 \cdot t \cdot (z_g + z_k) \text{ mm}$$

Calculation of the precise centre distance at a given synchronous drive belt length is possible on the basis of a very simple method with aid of table 48 (page 63 onwards).

Example

Given:

CONTI SYNCHROBELT® HTD Synchronous Drive Belt	960 – 8M	z = 120 teeth
HTD Toothed Pulley	PT58 – 8M	z _g = 58 teeth
HTD Toothed Pulley	PT40 – 8M	z _k = 40 teeth

1. Difference between the number of teeth of the synchronous drive belt and the number of teeth of the small toothed pulley z – z _k	120 – 40 = 80
2. Difference between the number of teeth of the large and of the small toothed pulley z _g – z _k	58 – 40 = 18
3. Centre distance factor at the point of intersection of column z – z _k and line z _g – z _k (page 67)	35.384
4. Product of the centre distance factor and pitch in mm of the selected tooth profile Centre distance factor · t The calculated value is the exact centre distance a in mm.	35.384 · 8 = 283.072 mm

The table applies to all synchronous drive belts indicated in this publication and to transmission ratios not equal to 1. With a transmission ratio of i = 1, the centre distance can be determined on the basis of the following formula:

$$a = \frac{L_w - \pi \cdot d_w}{2} \text{ mm} \quad \text{or} \quad a = \frac{t}{2} \cdot (z - z_1) \text{ mm}$$

In cases where the tabular values are insufficient, the centre distance can be approximately determined by means of the above formula.

Pitch Length L_w

The pitch length L_w of the synchronous drive belt is approximated to a drive with two pulleys:

$$L_w \approx 2 \cdot a + \frac{t}{2} \cdot (z_g + z_k) + \frac{\left[\frac{t}{\pi} \cdot (z_g - z_k) \right]^2}{4 \cdot a} \text{ mm}$$

and here the precise calculation:

$$L_w = 2 \cdot a \cdot \sin \frac{\beta}{2} + \frac{t}{2} \cdot \left[z_g + z_k + \left(1 - \frac{\beta}{180} \right) \cdot (z_g - z_k) \right] \text{ mm}$$

Calculation of the exact synchronous drive belt length at a given centre distance is possible by means of a very simple method with the aid of table 48 (page 63 onwards).

Example

Given:

HTD Toothed Pulley	PT58 – 8 M	$z_g = 58$ teeth
HTD Toothed Pulley	PT40 – 8 M	$z_k = 40$ teeth
Given centre distance a		$a \approx 300$ mm

1. Difference between the number of teeth of the large toothed pulley and the number of teeth of small toothed pulley $z_g - z_k$	$58 - 40 = 18$
2. Quotient from the centre distance in mm and the pitch in mm of the selected tooth profile $\frac{a}{t}$	$\frac{300}{8} = 37.5$
3. nearest centre distance factor on the line $z_g - z_k$ (page 78)	37.390
4. Corresponding difference between the number of teeth of the synchronous drive belt and the number of teeth of the toothed pulley $z - z_k$ obtained from the table	84
5. Sum of this value and of the number of teeth of the small pulley $(z - z_k) + z_k$	$84 + 40 = 124$
6. Product of the number of teeth of the synchronous drive belt and of the selected pitch in mm $z \cdot t$ The exact synchronous drive belt pitch length L_w in mm is the calculated value.	$124 \cdot 8 = 992$ mm

To avoid special sizes, please consider the application of CONTI SYNCHROBELT® HTD synchronous drive belts of the nearest standard length (see Table 3, page 13), e.g. by means of changing the centre distance.

Recommendation:

CONTI SYNCHROBELT® HTD Synchronous Drive Belt
960 – 8M with 120 teeth
Centre distance $a = 283.072$ mm

Belt Speed v

The belt speed v is a function of pitch t in mm, number of teeth z_k and speed n_k in min^{-1} of the small toothed pulley:

$$v = \frac{t \cdot z_k \cdot n_k}{60 \cdot 10^3} \text{ m/s}$$

Synchronous Drive Belt Width b

The synchronous drive belt width b in mm results from the power P to be transmitted, corrected by the overall service factor c_0 , and the power rating P_R , corrected by the teeth in mesh factor c_1 and the length factor c_5 . The following applies to a standard belt width:

$$P \cdot c_0 \leq P_R \cdot c_1 \cdot c_5$$

If

$$P \cdot c_0 > P_R \cdot c_1 \cdot c_5$$

the next larger standard width should be applied.

To obtain a synchronous drive belt width as narrow as possible, the toothed pulleys should be selected as large as possible. This will result in a longer service life at a lower bending load.

Synchronous Drive Belt Tension F_v

The overall tension F_v is a decisive factor for the efficiency and length of service life of a synchronous belt drive.

The following recommendation is given:

$$F_v = \frac{60 \cdot 10^6 \cdot P \cdot \sin \frac{\beta}{2}}{t \cdot z_k \cdot n_k} \text{ N}$$

The static belt side force F is a function of the overall tension F_v and of the wrap angle β on the small toothed pulley:

$$F_{\text{stat}} = \frac{F_v}{2 \cdot \sin \frac{\beta}{2}} \text{ N}$$

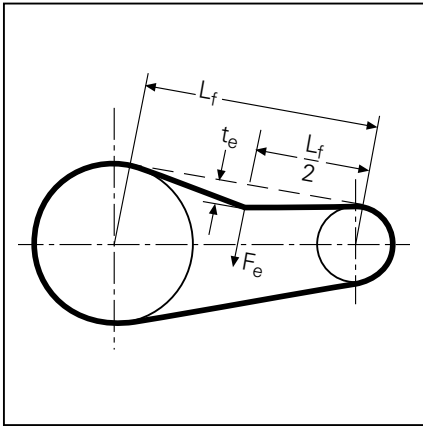

Belt deflection t_e Fig. 5

F_e _____ Test force in N
 t_e _____ Belt deflection in mm
 L_f _____ Free span length in mm

$$t_e = \frac{L_f}{1000} \cdot \text{Characteristic value of initial tension}$$

Checking the initial tension

a. Flexing method

The correct setting of the required initial tension F_v can be checked using Fig. 4. The calculation on page 45 gives explanatory notes on this.

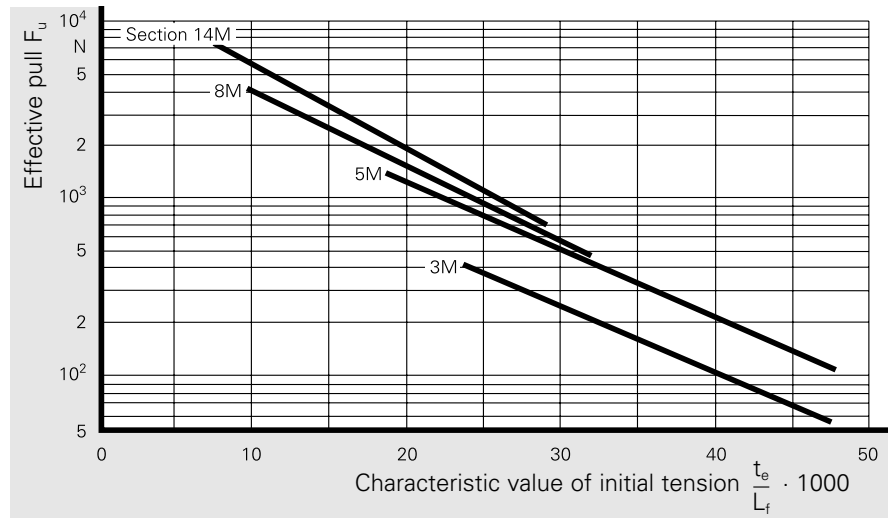

Characteristic lines of initial tension

Fig. 4

The test force F_e in N is calculated from the synchronous drive belt width b in mm, an allowance and a factor for the individual profiles as follows:

- Toothed profile 3M: $F_e = b + 15$
- Toothed profile 5M: $F_e = 2.6 b + 15$
- Toothed profile 8M: $F_e = b + 50$
- Toothed profile 14M: $F_e = b + 65$

b. Frequency measuring method

In this method, the initial tension is obtained by measuring the natural frequency of the part of the belt that is set vibrating.

$$F_{stat} = 4 \cdot 10^{-6} \cdot m \cdot L_f^2 \cdot f^2 \quad \text{N}$$

m _____ Synchronous drive belt weight in kg/m
 L_f _____ Free span length in mm
 f _____ Natural frequency in Hz

The specific belt weights m_s of CONTI SYNCHROBELT® HTD Synchronous Drive Belts are shown in table below.

Specific belt weights m_s

Table 32

Synchronous drive belt profile	HTD 3M	HTD 5M	HTD 8M	HTD 14M
m_s kg/m per mm belt width	$2.40 \cdot 10^{-3}$	$3.70 \cdot 10^{-3}$	$5.60 \cdot 10^{-3}$	$10.10 \cdot 10^{-3}$

Power Rating P_R

Tables 33 to 47 (pages 48 to 62) indicate the power rating P_R for CONTI SYNCHROBELT® HTD synchronous drive belts in kW as a function of the number of teeth z_k and/or of the pitch diameter of the small pulley d_{wk} and of the speed of the small toothed pulley n_k .

A table has been made up for each standard width.

Calculation Example

Prime mover:	Electric motor	$P = 5 \text{ kW}$
	with mean starting torque	$n_1 = 1450 \text{ min}^{-1}$
Driving machine:	Lathe	$n_2 = 1000 \text{ min}^{-1} \pm 2\%$
Operating conditions:	Diameter of large toothed pulley	$\cong 150 \text{ mm}$
	Centre distance $\approx 300 \text{ mm}$	
	Daily period of operation	16 hrs

Load factor c_2 from Table 27, page 36

$c_2 = 1.4$

Acceleration Factor c_3 from Table 28, page 37

$c_3 = 0$

Fatigue Factor c_4 from Table 29, page 37

$c_4 = 0.2$

Overall Service Factor

$c_0 = c_2 + c_3 + c_4$

$c_0 = 1.4 + 0 + 0.2 = 1.6$

Selection of Synchronous Drive Belt Pitch

Diagram Fig. 3, page 39

Selected:
CONTI SYNCHROBELT® HTD Synchronous Drive Belt 8M
 $t = 8 \text{ mm}$

Speed Ratio

$$i = \frac{n_1}{n_2} = \frac{z_2}{z_1}$$

$$i = \frac{1450}{1000} = 1.45$$

No. of Teeth and Pitch Diameter of the Toothed Pulleys z_g from Table 21, page 29

$z_2 = z_g$

$$z_1 = z_k = \frac{z_g}{i}$$

 d_{wk} from Table 15, page 25Condition: $d_{wg} \cong 150 \text{ mm}$

Selected:

$z_g = 58$

$d_{wg} = 147.70 \text{ mm}$

$z_k = \frac{58}{1.45} = 40$

$d_{wk} = 101.86 \text{ mm}$

Pitch Length

$$L_w \approx 2 \cdot a + \frac{t}{2} \cdot (z_g + z_k) + \frac{\left[\frac{t}{\pi} \cdot (z_g - z_k) \right]^2}{4 \cdot a}$$

$$L_w \approx 2 \cdot 300 + \frac{8}{2} \cdot (58 + 40) + \frac{\left[\frac{8}{\pi} \cdot (58 - 40) \right]^2}{4 \cdot 300} \approx 994 \text{ mm}$$

Determination of the Pitch Length that can be supplied L_w from Table 3, page 13

$L_w = 960 \text{ mm} \quad z = 120$

Centre distance

a from Table 48, page 68.

$$z - z_k$$

$$z_g - z_k$$

Centre distance factor from Table 48, page 67

a = centre distance factor · t

$$120 - 40 = 80$$

$$58 - 40 = 18$$

$$35.384$$

$$a = 35.384 \cdot 8 = 283.072 \text{ mm}$$

Belt Speed

$$v = \frac{t \cdot z_k \cdot n_k}{60 \cdot 10^3}$$

$$v = \frac{8 \cdot 40 \cdot 1450}{60 \cdot 10^3} = 7.73 \text{ m/s}$$

Wrap Angle on the Small Toothed Pulley

$$\beta = 2 \cdot \arccos \left[\frac{t \cdot (z_g - z_k)}{2 \cdot \pi \cdot a} \right]$$

$$\beta = 2 \cdot \arccos \left[\frac{8 \cdot (58 - 40)}{2 \cdot \pi \cdot 283.072} \right]$$

$$\beta = 170.71^\circ$$

Teeth in mesh Factor

$$z_e = z_k \cdot \frac{\beta}{360}$$

c₁ from Table 26, page 35

$$z_e = 40 \cdot \frac{170.71}{360} = 19$$

$$c_1 = 1.0$$

Length Factor

c₅ from Table 30, page 37

$$c_5 = 1.0$$

Synchronous Drive Belt Width

Requirement

$$P \cdot c_0 \leq P_R \cdot c_1 \cdot c_5$$

$$P \cdot c_0$$

$$P_R \cdot c_1 \cdot c_5$$

P_R from Table 39, page 54

$$5 \cdot 1.6 = 8 \text{ kW}$$

$$10.48 \cdot 1.0 \cdot 1.0 = 10.48 \text{ kW}$$

$$P_R = 10.48 \text{ kW}$$

for a synchronous drive belt width of 30 mm

$$8 \text{ kW} < 10.48 \text{ kW}$$

Requirement for a 30 mm wide synchronous drive belt

Layout:

1 CONTI SYNCHROBELT® HTD synchronous drive belt

960 – 8M – 30

1 HTD toothed pulley

PT40 – 8M – 30 F

1 HTD toothed pulley

PT58 – 8M – 30

Synchronous Drive Belt Tension

Overall tension

$$F_v = \frac{60 \cdot 10^6 \cdot P \cdot \sin \frac{\beta}{2}}{t \cdot z_k \cdot n_k}$$

$$F_v = \frac{60 \cdot 10^6 \cdot 5 \cdot \sin \frac{170.71}{2}}{8 \cdot 40 \cdot 1450} = 644.43 \text{ N}$$

Checking the initial tension

a. Flexing method

Test force for pitch 8 mm, see page 44

$$F_e = b + 50$$

Effective pull F_u

$$F_u = \frac{60 \cdot 10^6 \cdot P}{t \cdot z_k \cdot n_k}$$

Belt tension parameter for F_u and pitch 8 mm from diagram Fig. 4 page 44

$$\frac{t_e}{L_f} \cdot 1000$$

Free span length

$$L_f = a \cdot \sin \frac{\beta}{2}$$

Belt deflection

$$t_e = \frac{L_f}{1000} \cdot \text{belt tension parameter}$$

b. Frequency measuring method

Explanations: see page 44

m_s = specific weight of synchronous drive belt per m length and mm width for Table 32, page 44

b ____ width of synchronous drive belt

m ____ weight of synchronous drive belt per m length

$$m = m_s \cdot b$$

 L_f = free span length

Calculation: see point a. Flexing method

 F_{stat} ____ predefined static belt tension

Calculation: see page 38

the desired frequency derived from above

$$f = \sqrt{\frac{1 \cdot 10^6 \cdot F_{stat}}{4 \cdot m \cdot L_f^2}} \cdot \text{belt tension parameter}$$

$$F_e = 30 + 50 = 80 \text{ N}$$

$$F_u = \frac{60 \cdot 10^6 \cdot 5}{8 \cdot 40 \cdot 1450} = 646.55 \text{ N}$$

$$\frac{t_e}{L_f} \cdot 1000 = 29.5$$

$$L_f = 283.072 \cdot \sin \frac{170.71}{2} = 282 \text{ mm}$$

$$t_e = \frac{282}{1000} \cdot 29.5 \approx 8.3 \text{ mm}$$

Given the test force is 80 N and the deflection is 8.3 mm, the synchronous drive is properly tensioned for use.

$$m_s = 5.60 \cdot 10^{-3} \text{ kg/m} \cdot \text{mm}$$

$$F_e = 30 + 50 = 80 \text{ N}$$

$$m = 5.60 \cdot 10^{-3} \cdot 30 = 0.168 \text{ kg/m}$$

$$L_f = 282 \text{ mm}$$

$$F_{stat} = 323.28 \text{ N}$$

$$f = \sqrt{\frac{1 \cdot 10^6 \cdot 323.28}{4 \cdot 0.168 \cdot 282^2}} = 77.7 \text{ Hz}$$

If desired frequency coincides with actual measured frequency, then the belt is properly tensioned.

Result of belt calculation

1 CONTI SYNCHROBELT® HTD synchronous drive belt
960 – 8M – 30
1 HTD toothed pulley PT40 – 8M – 30 F
1 HTD toothed pulley PT58 – 8M – 30

CONTI SYNCHROBELT® HTD

Synchronous Drive Belt 3M 6 mm Belt Width Power Rating P_R (kW)

Table 33

Speed of small toothed pulley n_x r.p.m.	No. of teeth of small toothed pulley z_x														
	10	12	14	16	18	20	24	28	32	40	48	56	64	72	80
	Pitch $\varnothing d_w$ (mm)														
	9.55	11.46	13.37	15.28	17.19	19.10	22.92	26.74	30.56	38.20	45.84	53.48	61.12	68.75	76.39
20	0.001	0.001	0.001	0.001	0.002	0.002	0.002	0.003	0.003	0.004	0.005	0.007	0.008	0.008	0.009
40	0.002	0.002	0.002	0.003	0.003	0.003	0.004	0.005	0.006	0.009	0.011	0.013	0.015	0.017	0.019
60	0.002	0.003	0.003	0.004	0.005	0.005	0.007	0.008	0.009	0.013	0.016	0.020	0.023	0.025	0.028
100	0.004	0.005	0.006	0.007	0.008	0.009	0.011	0.013	0.016	0.021	0.027	0.033	0.038	0.042	0.047
200	0.008	0.010	0.011	0.013	0.015	0.017	0.022	0.027	0.032	0.043	0.055	0.066	0.075	0.084	0.094
300	0.011	0.013	0.016	0.018	0.021	0.024	0.030	0.036	0.043	0.057	0.073	0.087	0.100	0.112	0.125
400	0.013	0.016	0.019	0.023	0.026	0.029	0.037	0.045	0.053	0.070	0.090	0.107	0.122	0.138	0.153
500	0.016	0.019	0.023	0.027	0.031	0.035	0.043	0.053	0.062	0.083	0.105	0.125	0.143	0.161	0.179
600	0.018	0.022	0.026	0.031	0.035	0.040	0.050	0.060	0.071	0.094	0.120	0.142	0.163	0.183	0.203
700	0.020	0.025	0.030	0.035	0.040	0.045	0.056	0.067	0.080	0.105	0.133	0.159	0.181	0.204	0.226
800	0.023	0.028	0.033	0.038	0.044	0.050	0.062	0.075	0.088	0.116	0.147	0.174	0.199	0.224	0.249
900	0.025	0.030	0.036	0.042	0.048	0.054	0.068	0.081	0.096	0.126	0.159	0.189	0.216	0.243	0.270
950	0.026	0.032	0.038	0.044	0.050	0.057	0.070	0.085	0.100	0.132	0.166	0.197	0.225	0.253	0.280
1000	0.027	0.033	0.039	0.046	0.052	0.059	0.073	0.088	0.103	0.136	0.172	0.204	0.233	0.262	0.291
1200	0.031	0.038	0.045	0.052	0.060	0.068	0.084	0.101	0.118	0.156	0.195	0.232	0.264	0.297	0.330
1400	0.035	0.043	0.051	0.059	0.067	0.076	0.094	0.113	0.133	0.174	0.218	0.258	0.294	0.331	0.367
1450	0.036	0.044	0.052	0.061	0.069	0.078	0.097	0.116	0.136	0.178	0.223	0.264	0.302	0.339	0.376
1600	0.039	0.047	0.056	0.065	0.075	0.084	0.104	0.125	0.146	0.191	0.239	0.283	0.323	0.363	0.402
1800	0.042	0.052	0.062	0.071	0.082	0.092	0.114	0.136	0.159	0.208	0.260	0.307	0.350	0.393	0.436
2000	0.046	0.056	0.067	0.077	0.088	0.100	0.123	0.147	0.172	0.225	0.280	0.330	0.376	0.422	0.468
2400	0.053	0.065	0.077	0.089	0.101	0.114	0.141	0.168	0.197	0.256	0.317	0.374	0.426	0.477	0.527
2850	0.061	0.074	0.087	0.100	0.116	0.130	0.160	0.191	0.223	0.289	0.357	0.419	0.477	0.533	0.588
3200	0.066	0.081	0.096	0.111	0.126	0.142	0.174	0.208	0.242	0.313	0.386	0.452	0.513	0.573	0.630
3600	0.073	0.088	0.105	0.121	0.138	0.155	0.190	0.226	0.263	0.339	0.417	0.488	0.552	0.615	0.674
4000	0.079	0.096	0.113	0.131	0.149	0.168	0.205	0.244	0.284	0.365	0.447	0.521	0.588	0.652	0.713
5000	0.093	0.114	0.134	0.155	0.176	0.198	0.242	0.286	0.331	0.423	0.513	0.593	0.664	0.728	0.786
6000	0.108	0.131	0.154	0.178	0.202	0.226	0.275	0.325	0.375	0.473	0.569	0.650	0.718	0.776	0.823
7000	0.121	0.147	0.173	0.199	0.226	0.252	0.306	0.360	0.413	0.517	0.613	0.691	0.751	0.794	0.820
8000	0.134	0.162	0.191	0.219	0.248	0.277	0.335	0.392	0.448	0.553	0.646	0.715	0.758	0.778	0.771
10000	0.158	0.191	0.224	0.257	0.290	0.323	0.386	0.447	0.504	0.602	0.674	0.705	0.690	0.630	0.517
12000	0.181	0.218	0.255	0.291	0.327	0.362	0.428	0.488	0.540	0.617	0.645	0.607	0.494		
14000	0.203	0.243	0.283	0.322	0.359	0.394	0.459	0.514	0.556	0.592	0.551	0.407			

CONTI SYNCHROBELT® HTD

Synchronous Drive Belt 3M 9 mm Belt Width Power Rating P_R (kW)

Table 34

Speed of small toothed pulley n_x r.p.m.	No. of teeth of small toothed pulley z_x														
	10	12	14	16	18	20	24	28	32	40	48	56	64	72	80
	Pitch $\varnothing d_w$ (mm)														
	9.55	11.46	13.37	15.28	17.19	19.10	22.92	26.74	30.56	38.20	45.84	53.48	61.12	68.75	76.39
20	0.001	0.002	0.002	0.002	0.003	0.003	0.004	0.004	0.005	0.007	0.009	0.011	0.012	0.014	0.016
40	0.003	0.003	0.004	0.004	0.005	0.006	0.007	0.009	0.010	0.004	0.018	0.022	0.025	0.028	0.031
60	0.004	0.005	0.006	0.007	0.008	0.009	0.011	0.013	0.016	0.021	0.027	0.033	0.037	0.042	0.047
100	0.006	0.008	0.009	0.011	0.013	0.014	0.018	0.022	0.026	0.035	0.045	0.054	0.062	0.070	0.078
200	0.013	0.016	0.019	0.022	0.025	0.029	0.036	0.044	0.052	0.071	0.091	0.109	0.124	0.140	0.155
300	0.018	0.022	0.026	0.030	0.035	0.039	0.049	0.060	0.071	0.095	0.121	0.145	0.165	0.186	0.207
400	0.022	0.027	0.032	0.038	0.043	0.049	0.061	0.074	0.087	0.117	0.149	0.177	0.203	0.228	0.253
500	0.026	0.032	0.038	0.044	0.051	0.058	0.072	0.087	0.103	0.137	0.174	0.207	0.237	0.267	0.296
600	0.030	0.037	0.044	0.051	0.059	0.066	0.083	0.100	0.118	0.156	0.198	0.236	0.269	0.303	0.337
700	0.034	0.041	0.049	0.058	0.066	0.075	0.093	0.112	0.132	0.175	0.221	0.263	0.300	0.338	0.375
800	0.038	0.046	0.055	0.064	0.073	0.083	0.102	0.123	0.145	0.192	0.243	0.289	0.330	0.371	0.412
900	0.041	0.050	0.060	0.070	0.080	0.090	0.112	0.135	0.159	0.210	0.264	0.314	0.358	0.403	0.447
950	0.043	0.052	0.062	0.073	0.083	0.094	0.117	0.140	0.165	0.218	0.275	0.326	0.372	0.418	0.465
1000	0.045	0.055	0.065	0.076	0.086	0.098	0.121	0.146	0.171	0.226	0.285	0.338	0.386	0.434	0.482
1200	0.051	0.063	0.075	0.087	0.099	0.112	0.139	0.167	0.196	0.258	0.324	0.384	0.438	0.493	0.547
1400	0.058	0.071	0.084	0.098	0.112	0.126	0.156	0.187	0.220	0.288	0.361	0.427	0.488	0.548	0.608
1450	0.060	0.073	0.086	0.100	0.116	0.129	0.160	0.192	0.225	0.295	0.370	0.438	0.500	0.562	0.623
1600	0.064	0.078	0.093	0.108	0.124	0.139	0.172	0.207	0.242	0.317	0.397	0.469	0.535	0.601	0.667
1800	0.070	0.086	0.102	0.118	0.135	0.152	0.188	0.225	0.264	0.345	0.431	0.509	0.580	0.652	0.722
2000	0.076	0.093	0.110	0.128	0.146	0.165	0.204	0.244	0.285	0.372	0.464	0.547	0.624	0.700	0.776
2400	0.088	0.107	0.127	0.147	0.168	0.189	0.233	0.279	0.326	0.424	0.526	0.620	0.706	0.791	0.875
2850	0.100	0.122	0.145	0.168	0.191	0.216	0.265	0.316	0.369	0.478	0.592	0.696	0.791	0.885	0.977
3200	0.110	0.134	0.158	0.183	0.209	0.235	0.289	0.344	0.401	0.519	0.640	0.751	0.853	0.952	1.049
3600	0.120	0.146	0.173	0.201	0.228	0.257	0.315	0.375	0.437	0.563	0.693	0.811	0.919	1.023	1.124
4000	0.130	0.159	0.188	0.217	0.247	0.278	0.341	0.405	0.471	0.605	0.742	0.866	0.979	1.087	1.191
5000	0.155	0.188	0.222	0.257	0.292	0.328	0.401	0.475	0.550	0.702	0.854	0.989	1.109	1.220	1.321
6000	0.178	0.216	0.255	0.295	0.334	0.375	0.457	0.539	0.623	0.788	0.945	1.088	1.207	1.310	1.396
7000	0.200	0.243	0.286	0.330	0.374	0.419	0.509	0.599	0.688	0.863	1.027	1.163	1.270	1.353	1.409
8000	0.222	0.269	0.316	0.364	0.412	0.461	0.557	0.653	0.747	0.926	1.087	1.211	1.295	1.344	1.354
10000	0.263	0.317	0.372	0.427	0.482	0.537	0.643	0.746	0.844	1.017	1.150	1.219	1.220	1.152	1.007
12000	0.301	0.363	0.424	0.485	0.544	0.603	0.715	0.819	0.911	1.054	1.125	1.094	0.952		
14000	0.337	0.404	0.471	0.536	0.599	0.660	0.772	0.869	0.947	1.032	1.001	0.816			

CONTI SYNCHROBELT® HTD

Synchronous Drive Belt 3M 15 mm Belt Width Power Rating P_R (kW)

Table 35

Speed of small toothed pulley n _s r.p.m.	No. of teeth of small toothed pulley z _s														
	10	12	14	16	18	20	24	28	32	40	48	56	64	72	80
	Pitch Ø d _w (mm)														
	9.55	11.46	13.37	15.28	17.19	19.10	22.92	26.74	30.56	38.20	45.84	53.48	61.12	68.75	76.39
20	0.002	0.003	0.003	0.004	0.005	0.005	0.006	0.008	0.009	0.013	0.016	0.020	0.022	0.025	0.028
40	0.005	0.006	0.007	0.008	0.009	0.010	0.013	0.016	0.019	0.025	0.033	0.039	0.045	0.050	0.056
60	0.007	0.008	0.010	0.012	0.014	0.016	0.019	0.024	0.028	0.038	0.049	0.059	0.067	0.075	0.084
100	0.012	0.014	0.017	0.020	0.023	0.026	0.032	0.039	0.047	0.053	0.081	0.098	0.111	0.125	0.139
200	0.023	0.028	0.034	0.040	0.046	0.052	0.065	0.079	0.094	0.127	0.163	0.195	0.223	0.251	0.279
300	0.032	0.039	0.046	0.054	0.062	0.070	0.088	0.107	0.127	0.170	0.217	0.259	0.297	0.334	0.371
400	0.039	0.048	0.058	0.067	0.077	0.088	0.109	0.132	0.157	0.209	0.267	0.318	0.363	0.408	0.454
500	0.047	0.057	0.068	0.080	0.091	0.104	0.125	0.156	0.184	0.246	0.312	0.372	0.425	0.478	0.531
600	0.054	0.066	0.079	0.092	0.105	0.119	0.148	0.179	0.211	0.230	0.355	0.423	0.483	0.543	0.604
700	0.061	0.074	0.088	0.103	0.118	0.134	0.166	0.200	0.236	0.313	0.396	0.471	0.538	0.606	0.673
800	0.067	0.082	0.098	0.114	0.131	0.148	0.184	0.221	0.261	0.345	0.436	0.518	0.591	0.665	0.739
900	0.074	0.090	0.107	0.125	0.143	0.162	0.201	0.242	0.234	0.376	0.474	0.562	0.642	0.722	0.802
950	0.077	0.094	0.112	0.130	0.149	0.169	0.209	0.251	0.296	0.391	0.492	0.584	0.667	0.750	0.833
1000	0.080	0.098	0.116	0.135	0.155	0.175	0.217	0.261	0.307	0.435	0.510	0.605	0.691	0.778	0.863
1200	0.092	0.113	0.134	0.156	0.178	0.201	0.249	0.299	0.331	0.462	0.580	0.688	0.786	0.883	0.980
1400	0.104	0.127	0.151	0.175	0.200	0.226	0.279	0.335	0.394	0.517	0.647	0.766	0.875	0.983	1.091
1450	0.107	0.130	0.155	0.180	0.206	0.232	0.287	0.344	0.404	0.530	0.663	0.785	0.896	1.007	1.118
1600	0.115	0.141	0.167	0.194	0.222	0.250	0.309	0.370	0.434	0.539	0.711	0.841	0.960	1.078	1.196
1800	0.126	0.154	0.183	0.212	0.242	0.273	0.337	0.434	0.473	0.619	0.772	0.912	1.041	1.169	1.296
2000	0.137	0.167	0.198	0.230	0.262	0.296	0.365	0.437	0.511	0.637	0.831	0.981	1.119	1.256	1.392
2400	0.158	0.192	0.228	0.264	0.301	0.340	0.418	0.500	0.584	0.730	0.944	1.112	1.267	1.420	1.571
2850	0.180	0.219	0.260	0.301	0.343	0.386	0.475	0.567	0.662	0.858	1.062	1.249	1.421	1.590	1.756
3200	0.197	0.240	0.284	0.329	0.375	0.422	0.518	0.617	0.720	0.931	1.149	1.349	1.532	1.711	1.887
3600	0.216	0.262	0.310	0.359	0.410	0.461	0.565	0.673	0.783	1.010	1.244	1.456	1.651	1.840	2.023
4000	0.234	0.285	0.336	0.389	0.443	0.498	0.611	0.726	0.844	1.086	1.333	1.557	1.761	1.958	2.146
5000	0.278	0.338	0.399	0.461	0.524	0.588	0.719	0.852	0.988	1.232	1.536	1.781	2.000	2.204	2.391
6000	0.319	0.388	0.458	0.528	0.600	0.673	0.820	0.969	1.118	1.418	1.710	1.964	2.183	2.376	2.542
7000	0.360	0.436	0.514	0.592	0.672	0.752	0.914	1.076	1.238	1.554	1.855	2.106	2.308	2.470	2.588
8000	0.398	0.482	0.568	0.654	0.740	0.827	1.001	1.175	1.345	1.672	1.969	2.202	2.369	2.478	2.519
10000	0.471	0.570	0.669	0.768	0.866	0.965	1.158	1.346	1.524	1.645	2.100	2.247	2.280	2.198	1.986
12000	0.540	0.651	0.762	0.871	0.979	1.086	1.291	1.481	1.654	1.929	2.084	2.069	1.867		
14000	0.605	0.727	0.847	0.965	1.079	1.190	1.397	1.578	1.729	1.913	1.902	1.633			

CONTI SYNCHROBELT® HTD

Synchronous Drive Belt 5M 9 mm Belt Width Power Rating P_R (kW)

Table 36

Speed of small toothed pulley n _x r.p.m.	No. of teeth of small toothed pulley z _k														
	14	16	20	24	28	32	36	40	44	48	56	56	64	72	80
	Pitch Ø d _w (mm)														
	22.28	25.46	28.65	31.83	38.20	44.56	50.93	57.30	63.66	70.03	76.39	89.13	101.86	114.59	127.32
20	0.004	0.005	0.006	0.007	0.009	0.011	0.013	0.015	0.017	0.020	0.022	0.027	0.031	0.034	0.038
40	0.009	0.011	0.012	0.014	0.017	0.021	0.025	0.030	0.035	0.040	0.045	0.054	0.061	0.069	0.077
60	0.013	0.016	0.018	0.021	0.026	0.032	0.038	0.045	0.052	0.059	0.067	0.080	0.092	0.103	0.115
100	0.022	0.026	0.030	0.035	0.044	0.053	0.064	0.075	0.086	0.099	0.112	0.134	0.153	0.172	0.192
200	0.045	0.053	0.061	0.069	0.087	0.107	0.127	0.149	0.173	0.198	0.224	0.288	0.306	0.345	0.383
300	0.061	0.072	0.083	0.094	0.118	0.144	0.172	0.201	0.232	0.264	0.298	0.357	0.407	0.458	0.509
400	0.076	0.089	0.103	0.117	0.147	0.178	0.212	0.247	0.285	0.324	0.365	0.436	0.499	0.561	0.623
500	0.091	0.106	0.122	0.139	0.173	0.210	0.250	0.291	0.335	0.380	0.428	0.510	0.583	0.656	0.728
600	0.104	0.122	0.140	0.159	0.199	0.241	0.285	0.332	0.381	0.433	0.486	0.580	0.662	0.745	0.827
700	0.117	0.137	0.158	0.179	0.223	0.270	0.320	0.372	0.426	0.483	0.542	0.646	0.738	0.829	0.921
800	0.130	0.152	0.174	0.198	0.246	0.298	0.352	0.410	0.469	0.531	0.596	0.709	0.809	0.910	1.010
900	0.142	0.166	0.191	0.216	0.269	0.325	0.384	0.446	0.511	0.578	0.647	0.769	0.879	0.987	1.096
950	0.148	0.173	0.199	0.225	0.280	0.338	0.400	0.464	0.531	0.600	0.672	0.799	0.912	1.026	1.137
1000	0.154	0.180	0.206	0.234	0.291	0.352	0.415	0.481	0.551	0.623	0.697	0.828	0.945	1.062	1.178
1200	0.177	0.207	0.237	0.268	0.334	0.402	0.474	0.549	0.627	0.708	0.792	0.939	1.071	1.203	1.334
1400	0.199	0.232	0.266	0.301	0.374	0.451	0.531	0.614	0.700	0.790	0.882	1.044	1.190	1.335	1.479
1450	0.205	0.239	0.273	0.309	0.384	0.462	0.544	0.630	0.718	0.809	0.903	1.069	1.219	1.367	1.514
1600	0.221	0.257	0.295	0.333	0.413	0.497	0.585	0.676	0.770	0.867	0.967	1.143	1.302	1.459	1.614
1800	0.242	0.281	0.322	0.364	0.451	0.542	0.637	0.735	0.837	0.941	1.048	1.238	1.408	1.576	1.741
2000	0.262	0.305	0.349	0.394	0.488	0.585	0.687	0.792	0.901	1.012	1.126	1.328	1.508	1.686	1.859
2400	0.301	0.350	0.400	0.451	0.558	0.668	0.783	0.901	1.022	1.146	1.272	1.494	1.693	1.885	2.071
2850	0.343	0.398	0.455	0.513	0.632	0.756	0.884	1.015	1.148	1.284	1.421	1.663	1.875	2.077	2.268
3200	0.374	0.434	0.496	0.559	0.688	0.821	0.958	1.098	1.240	1.383	1.528	1.780	1.998	2.203	2.391
3600	0.409	0.474	0.541	0.609	0.749	0.892	1.039	1.187	1.337	1.488	1.639	1.899	2.119	2.320	2.497
4000	0.443	0.513	0.585	0.658	0.807	0.959	1.114	1.271	1.428	1.584	1.739	2.002	2.218	2.407	2.564
5000	0.523	0.605	0.688	0.771	0.941	1.113	1.284	1.454	1.620	1.783	1.939	2.186	2.362	2.484	2.545
6000	0.598	0.689	0.782	0.875	1.061	1.246	1.426	1.600	1.765	1.920	2.061	2.255	2.342	2.335	2.222
7000	0.668	0.768	0.869	0.969	1.166	1.357	1.538	1.706	1.857	1.989	2.099	2.195	2.135		
8000	0.733	0.841	0.948	1.053	1.257	1.447	1.619	1.770	1.893	1.985	2.043	1.990			
10000	0.850	0.968	1.082	1.191	1.388	1.553	1.678	1.753	1.772	1.726	1.608				
12000	0.950	1.071	1.183	1.284	1.449	1.552	1.579	1.518	1.355						
14000	1.030	1.146	1.247	1.329	1.429	1.426	1.299								

CONTI SYNCHROBELT® HTD

Synchronous Drive Belt 5M 15 mm Belt Width Power Rating P_R (kW)

Table 37

Speed of small toothed pulley n _s r.p.m.	No. of teeth of small toothed pulley z _k														
	14	16	20	24	28	32	36	40	44	48	56	56	64	72	80
	Pitch Ø d _w (mm)														
	22.28	25.46	28.65	31.83	38.20	44.56	50.93	57.30	63.66	70.03	76.39	89.13	101.86	114.59	127.32
20	0.009	0.010	0.012	0.013	0.017	0.020	0.024	0.028	0.033	0.037	0.042	0.051	0.058	0.065	0.073
40	0.017	0.020	0.023	0.026	0.033	0.040	0.048	0.057	0.065	0.075	0.085	0.102	0.116	0.131	0.145
60	0.026	0.030	0.035	0.039	0.050	0.061	0.072	0.085	0.098	0.112	0.127	0.152	0.174	0.196	0.218
100	0.043	0.050	0.058	0.066	0.083	0.101	0.121	0.141	0.164	0.187	0.212	0.254	0.290	0.327	0.363
200	0.085	0.100	0.115	0.131	0.165	0.202	0.241	0.283	0.327	0.374	0.424	0.508	0.581	0.653	0.726
300	0.116	0.136	0.157	0.178	0.224	0.273	0.325	0.380	0.439	0.500	0.565	0.675	0.772	0.868	0.965
400	0.145	0.169	0.195	0.222	0.278	0.338	0.401	0.469	0.540	0.614	0.692	0.826	0.944	1.062	1.180
500	0.172	0.201	0.231	0.262	0.328	0.399	0.473	0.551	0.634	0.720	0.810	0.966	1.104	1.242	1.380
600	0.198	0.231	0.265	0.301	0.376	0.456	0.541	0.629	0.723	0.820	0.922	1.098	1.255	1.411	1.567
700	0.222	0.260	0.298	0.338	0.422	0.511	0.605	0.704	0.807	0.915	1.027	1.223	1.397	1.571	1.745
800	0.246	0.287	0.330	0.374	0.467	0.565	0.668	0.776	0.889	1.007	1.129	1.343	1.534	1.724	1.915
900	0.269	0.314	0.361	0.409	0.510	0.616	0.728	0.845	0.967	1.095	1.226	1.458	1.665	1.871	2.077
950	0.281	0.328	0.376	0.426	0.531	0.641	0.757	0.879	1.006	1.137	1.274	1.514	1.729	1.943	2.156
1000	0.292	0.341	0.391	0.443	0.551	0.666	0.786	0.912	1.043	1.180	1.321	1.569	1.791	2.013	2.233
1200	0.336	0.391	0.449	0.508	0.632	0.762	0.899	1.041	1.189	1.342	1.501	1.780	2.031	2.281	2.530
1400	0.378	0.440	0.504	0.571	0.709	0.854	1.006	1.163	1.327	1.497	1.671	1.980	2.257	2.533	2.807
1450	0.388	0.452	0.518	0.586	0.728	0.876	1.032	1.193	1.361	1.534	1.712	2.028	2.312	2.594	2.873
1600	0.418	0.487	0.558	0.631	0.783	0.942	1.108	1.281	1.459	1.644	1.833	2.169	2.471	2.771	3.067
1800	0.458	0.533	0.610	0.689	0.855	1.027	1.207	1.394	1.586	1.785	1.988	2.349	2.674	2.994	3.310
2000	0.496	0.577	0.661	0.746	0.924	1.110	1.303	1.502	1.708	1.920	2.136	2.520	2.866	3.205	3.539
2400	0.570	0.663	0.758	0.855	1.057	1.267	1.485	1.709	1.940	2.175	2.415	2.840	3.221	3.591	3.951
2850	0.649	0.754	0.862	0.972	1.199	1.435	1.678	1.927	2.181	2.440	2.703	3.166	3.576	3.969	4.344
3200	0.709	0.823	0.940	1.059	1.305	1.559	1.819	2.086	2.357	2.632	2.909	3.394	3.820	4.221	4.596
3600	0.775	0.899	1.026	1.155	1.421	1.694	1.973	2.258	2.545	2.835	3.126	3.630	4.064	4.464	4.826
4000	0.839	0.973	1.109	1.248	1.532	1.823	2.119	2.419	2.721	3.022	3.323	3.837	4.270	4.655	4.989
5000	0.991	1.147	1.305	1.465	1.790	2.119	2.449	2.777	3.102	3.419	3.728	4.229	4.606	4.893	5.078
6000	1.134	1.309	1.486	1.665	2.022	2.379	2.729	3.071	3.399	3.710	4.001	4.424	4.664	4.748	4.655
7000	1.268	1.461	1.654	1.846	2.229	2.601	2.959	3.296	3.607	3.886	4.129	4.400	4.406		
8000	1.394	1.601	1.807	2.011	2.409	2.786	3.135	3.448	3.718	3.937	4.097	4.131			
10000	1.622	1.851	2.073	2.287	2.686	3.031	3.310	3.509	3.614	3.613	3.491				
12000	1.818	2.056	2.281	2.488	2.841	3.092	3.219	3.200	3.013						
14000	1.981	2.216	2.426	2.606	2.860	2.944	2.823								

CONTI SYNCHROBELT® HTD

Synchronous Drive Belt 5M 25 mm Belt Width Power Rating P_R (kW)

Table 38

Speed of small toothed pulley n_x r.p.m.	No. of teeth of small toothed pulley z_k														
	14	16	18	20	24	28	32	36	40	44	48	56	64	72	80
	Pitch $\varnothing d_w$ (mm)														
	22.28	25.46	28.65	31.83	38.20	44.56	50.93	57.30	63.66	70.03	76.39	89.13	101.86	114.59	127.32
20	0.015	0.018	0.021	0.023	0.030	0.036	0.043	0.051	0.058	0.067	0.076	0.091	0.104	0.117	0.130
40	0.030	0.036	0.041	0.047	0.059	0.072	0.086	0.101	0.117	0.134	0.151	0.182	0.207	0.233	0.259
60	0.046	0.054	0.062	0.070	0.089	0.108	0.129	0.152	0.175	0.201	0.227	0.272	0.311	0.350	0.389
100	0.076	0.089	0.103	0.117	0.148	0.180	0.215	0.253	0.292	0.334	0.379	0.454	0.519	0.584	0.648
200	0.152	0.179	0.206	0.235	0.296	0.361	0.431	0.506	0.585	0.669	0.757	0.908	1.037	1.167	1.297
300	0.208	0.243	0.280	0.319	0.400	0.488	0.581	0.679	0.784	0.893	1.009	1.207	1.379	1.551	1.724
400	0.259	0.303	0.349	0.396	0.497	0.604	0.717	0.837	0.964	1.097	1.236	1.477	1.688	1.898	2.109
500	0.307	0.359	0.413	0.469	0.587	0.712	0.845	0.985	1.132	1.287	1.448	1.727	1.973	2.220	2.466
600	0.353	0.413	0.474	0.538	0.673	0.815	0.966	1.125	1.291	1.465	1.647	1.962	2.242	2.522	2.801
700	0.397	0.464	0.533	0.605	0.765	0.814	1.082	1.258	1.443	1.636	1.836	2.186	2.497	2.808	3.118
800	0.440	0.514	0.590	0.669	0.834	1.009	1.193	1.386	1.588	1.799	2.017	2.400	2.741	3.082	3.422
900	0.481	0.562	0.645	0.731	0.911	1.101	1.301	1.510	1.729	1.956	2.192	2.605	2.975	3.345	3.713
950	0.502	0.585	0.672	0.761	0.948	1.146	1.353	1.571	1.797	2.033	2.277	2.705	3.089	3.472	3.864
1000	0.522	0.609	0.699	0.791	0.985	1.190	1.405	1.630	1.865	2.108	2.360	2.804	3.201	3.598	3.993
1200	0.600	0.699	0.802	0.908	1.129	1.362	1.606	1.860	2.125	2.399	2.682	3.182	3.631	4.078	4.523
1400	0.675	0.786	0.901	1.020	1.267	1.526	1.797	2.079	2.372	2.675	2.987	3.539	4.036	4.530	5.020
1450	0.693	0.808	0.926	1.047	1.300	1.566	1.844	2.133	2.432	2.742	3.061	3.625	4.134	4.639	5.140
1600	0.747	0.870	0.997	1.128	1.399	1.684	1.981	2.289	2.609	2.938	3.277	3.878	4.419	4.956	5.487
1800	0.818	0.952	1.090	1.232	1.527	1.836	2.157	2.491	2.836	3.130	3.554	4.200	4.783	5.358	5.925
2000	0.886	1.031	1.180	1.334	1.651	1.983	2.328	2.686	3.054	3.433	3.820	4.508	5.128	5.738	6.337
2400	1.018	1.184	1.354	1.529	1.890	2.265	2.655	3.056	3.469	3.831	4.321	5.083	5.768	6.435	7.084
2850	1.161	1.348	1.541	1.738	2.144	2.665	3.000	3.447	3.903	4.367	4.838	5.670	6.411	7.123	7.803
3200	1.267	1.471	1.680	1.894	2.333	2.787	3.255	3.733	4.219	4.712	5.210	6.085	6.855	7.586	8.272
3600	1.385	1.607	1.834	2.066	2.541	3.030	3.531	4.042	4.559	5.080	5.603	6.515	7.304	8.038	8.707
4000	1.500	1.739	1.983	2.231	2.740	3.262	3.794	4.333	4.876	5.420	5.962	6.896	7.688	8.403	9.030
5000	1.773	2.052	2.335	2.622	3.205	3.796	4.390	4.983	5.570	6.147	6.710	7.634	8.347	8.908	9.300
6000	2.029	2.343	2.660	2.980	3.624	4.267	4.902	5.522	6.122	6.694	7.233	8.039	8.534	8.769	8.710
7000	2.269	2.615	2.962	3.309	3.999	4.675	5.327	5.946	6.522	7.047	7.511	8.075	8.192		
8000	2.496	2.868	3.240	3.608	4.329	5.018	5.661	6.246	6.759	7.188	7.521	7.701			
10000	2.908	3.321	3.725	4.115	4.847	5.493	6.030	6.435	6.685	6.757	6.630				
12000	3.265	3.699	4.111	4.495	5.161	5.659	5.953	6.004	5.775						
14000	3.566	3.999	4.391	4.734	5.245	5.474	5.363								

CONTI SYNCHROBELT® HTD

Synchronous Drive Belt 8M 20 mm Belt Width Power Rating P_R (kW)

Table 39

Speed of small toothed pulley n_x r.p.m.	No. of teeth of small toothed pulley z_x																
	22	24	26	28	30	32	34	36	38	40	44	48	52	56	64	72	80
	Pitch $\varnothing d_w$ (mm)																
	56.02	61.12	66.21	71.30	76.39	81.49	86.58	91.67	96.77	101.86	112.05	122.23	132.42	142.60	162.97	183.35	203.72
10	0.02	0.02	0.02	0.03	0.03	0.04	0.04	0.05	0.05	0.06	0.06	0.07	0.07	0.08	0.09	0.10	0.11
20	0.03	0.04	0.04	0.05	0.06	0.07	0.08	0.09	0.10	0.11	0.12	0.13	0.14	0.15	0.17	0.19	0.21
50	0.08	0.09	0.11	0.13	0.16	0.18	0.21	0.23	0.26	0.28	0.31	0.33	0.36	0.38	0.43	0.48	0.53
100	0.16	0.18	0.22	0.27	0.31	0.36	0.41	0.47	0.52	0.56	0.62	0.67	0.72	0.77	0.87	0.96	1.06
200	0.33	0.37	0.45	0.53	0.62	0.72	0.82	0.93	1.05	1.13	1.24	1.34	1.44	1.54	1.73	1.93	2.12
300	0.49	0.53	0.65	0.77	0.90	1.04	1.19	1.34	1.51	1.64	1.78	1.93	2.07	2.22	2.50	2.77	3.05
400	0.65	0.71	0.84	0.99	1.16	1.34	1.54	1.74	1.96	2.12	2.31	2.50	2.68	2.87	3.23	3.59	3.94
500	0.81	0.89	1.02	1.22	1.42	1.64	1.88	2.13	2.39	2.59	2.82	3.05	3.27	3.50	3.94	4.37	4.80
600	0.98	1.07	1.21	1.43	1.67	1.93	2.21	2.51	2.82	3.05	3.32	3.59	3.85	4.11	4.63	5.13	5.63
700	1.14	1.24	1.38	1.64	1.92	2.22	2.54	2.88	3.23	3.50	3.81	4.11	4.41	4.71	5.30	5.88	6.44
800	1.30	1.42	1.56	1.85	2.17	2.50	2.86	3.24	3.64	3.94	4.29	4.63	4.97	5.30	5.96	6.60	7.23
950	1.55	1.69	1.83	2.16	2.52	2.91	3.33	3.77	4.24	4.59	4.99	6.38	5.78	6.16	6.92	7.66	8.38
1000	1.63	1.77	1.93	2.26	2.64	3.05	3.49	3.95	4.44	4.80	5.22	5.63	6.04	6.44	7.23	8.00	8.76
1200	1.95	2.13	2.31	2.65	3.10	3.58	4.09	4.64	5.21	5.63	6.12	6.60	7.08	7.54	8.46	9.34	10.20
1450	2.35	2.57	2.79	3.14	3.66	4.23	4.83	5.47	6.15	6.64	7.21	7.78	8.33	8.87	9.92	10.93	11.90
1600	2.60	2.83	3.07	3.42	3.99	4.61	5.27	5.96	6.69	7.23	7.85	8.46	9.05	9.63	10.76	11.83	12.86
1800	2.92	3.18	3.45	3.79	4.42	5.11	5.83	6.60	7.41	8.00	8.68	9.34	9.99	10.62	11.83	12.99	14.07
2000	3.24	3.53	3.83	4.19	4.84	5.59	6.38	7.22	8.11	8.76	9.49	10.20	10.89	11.57	12.86	14.07	15.20
2200	3.56	3.87	4.20	4.59	5.26	6.06	6.92	7.83	8.73	9.49	10.27	11.03	11.77	12.48	13.84	15.09	16.25
2500	4.03	4.39	4.76	5.20	5.86	6.75	7.71	8.71	9.78	10.55	11.40	12.23	13.02	13.78	15.20	16.49	17.63
2850	4.58	4.98	5.40	5.89	6.53	7.53	8.59	9.71	10.88	11.74	12.66	13.54	14.38	15.18	16.64	17.90	18.97
3000	4.81	5.23	5.67	6.19	6.81	7.85	8.95	10.12	11.34	12.23	13.17	14.07	14.93	15.74	17.19	18.43	19.44
3500	5.58	6.06	6.56	7.15	7.76	8.88	10.12	11.43	12.80	13.78	14.79	15.74	16.61	17.42	18.79	19.84	20.53
4000	6.34	6.87	7.42	8.09	8.76	9.84	11.20	12.64	14.15	15.20	16.25	17.19	18.05	18.79	19.96	20.65	
4500	7.07	7.66	8.26	8.98	9.71	10.73	12.20	13.75	15.37	16.49	17.53	18.43	19.21	19.84	20.65		
5000	7.79	8.42	9.07	9.84	10.62	11.53	13.10	14.75	16.47	17.63	18.62	19.44	20.08	20.53			
5500	8.49	9.16	9.84	10.65	11.47	12.28	13.90	15.63	17.43	18.62	19.51	20.18	20.62				
6000	9.16	9.86	10.57	11.42	12.26	13.09	14.60	16.39	18.25	19.44	20.18	20.65					

CONTI SYNCHROBELT® HTD

Synchronous Drive Belt 8M 30 mm Belt Width Power Rating P_R (kW)

Table 40

Speed of small toothed pulley n_x r.p.m.	No. of teeth of small toothed pulley z_k																
	22	24	26	28	30	32	34	36	38	40	44	48	52	56	64	72	80
	Pitch $\varnothing d_w$ (mm)																
	56.02	61.12	66.21	71.30	76.39	81.49	86.58	91.67	96.77	101.86	112.05	122.23	132.42	142.60	162.97	183.35	203.72
10	0.03	0.03	0.04	0.04	0.05	0.06	0.06	0.07	0.08	0.09	0.10	0.11	0.11	0.12	0.14	0.15	0.17
20	0.05	0.06	0.07	0.08	0.10	0.11	0.13	0.15	0.17	0.18	0.19	0.21	0.23	0.24	0.27	0.30	0.33
50	0.13	0.15	0.18	0.21	0.24	0.28	0.32	0.37	0.41	0.44	0.49	0.53	0.57	0.61	0.68	0.76	0.84
100	0.26	0.29	0.35	0.42	0.49	0.57	0.65	0.73	0.83	0.83	0.97	1.05	1.13	1.21	1.37	1.52	1.67
200	0.51	0.58	0.70	0.84	0.98	1.13	1.25	1.47	1.65	1.78	1.95	2.11	2.27	2.42	2.73	3.04	3.34
300	0.77	0.84	1.02	1.21	1.41	1.63	1.87	2.12	2.38	2.58	2.81	3.04	3.27	3.49	3.94	4.38	4.81
400	1.03	1.12	1.32	1.57	1.83	2.12	2.42	2.75	3.09	3.34	3.64	3.94	4.23	4.52	5.09	5.66	6.21
500	1.28	1.40	1.61	1.92	2.24	2.59	2.96	3.35	3.78	4.08	4.45	4.81	5.16	5.52	6.21	6.90	7.57
600	1.54	1.68	1.90	2.26	2.64	3.05	3.49	3.95	4.44	4.81	5.24	5.66	6.07	6.49	7.30	8.10	8.88
700	1.80	1.96	2.18	2.59	3.03	3.50	4.00	4.54	5.10	5.52	6.00	6.49	6.96	7.43	8.36	9.27	10.17
800	2.05	2.24	2.46	2.92	3.42	3.95	4.51	5.11	5.74	6.21	6.76	7.30	7.83	8.36	9.40	10.42	11.41
950	2.44	2.66	2.89	3.40	3.98	4.60	5.25	5.95	6.69	7.23	7.87	8.49	9.11	9.72	10.92	12.09	13.23
1000	2.57	2.80	3.04	3.56	4.17	4.81	5.50	6.23	7.00	7.57	8.23	8.88	9.53	10.17	11.41	12.63	13.82
1200	3.08	3.36	3.64	4.19	4.90	5.65	6.45	7.31	8.22	8.88	9.66	10.42	11.17	11.90	13.35	14.75	16.10
1450	3.71	4.05	4.40	4.95	5.78	6.67	7.62	8.63	9.70	10.48	11.38	12.27	13.14	13.99	16.66	17.26	18.80
1600	4.09	4.46	4.85	5.39	6.30	7.27	8.31	9.40	10.56	11.41	12.39	13.35	14.28	15.20	16.99	18.69	20.33
1800	4.60	5.01	5.44	5.98	6.98	8.06	9.20	10.41	11.69	12.63	13.70	14.75	15.77	16.77	18.69	20.53	22.26
2000	5.11	5.56	6.04	6.60	7.65	8.82	10.07	11.40	12.79	13.82	14.98	16.10	17.20	18.27	20.33	22.26	24.06
2200	5.61	6.11	6.63	7.25	8.30	9.57	10.92	12.36	13.87	14.98	16.22	17.42	18.59	19.72	21.88	23.89	25.73
2500	6.36	6.92	7.51	8.21	9.25	10.66	12.17	13.76	15.44	16.66	18.01	19.32	20.58	21.79	24.06	26.13	27.97
2850	7.23	7.86	8.52	9.31	10.31	11.89	13.56	15.33	17.19	18.54	20.00	21.41	22.74	24.02	26.36	28.42	30.16
3000	7.59	8.26	8.95	9.77	10.76	12.40	14.14	15.98	17.92	19.32	20.82	22.26	23.62	24.91	27.26	29.28	30.94
3500	8.81	9.57	10.36	11.30	12.26	14.03	15.99	18.06	20.24	21.79	23.40	24.91	26.32	27.62	29.87	31.62	32.83
4000	10.01	10.86	11.73	12.78	13.85	15.56	17.72	19.99	22.38	24.06	25.73	27.26	28.65	29.87	31.83	33.07	
4500	11.17	12.11	13.06	14.21	15.37	16.98	19.31	21.77	24.34	26.13	27.80	29.28	30.56	31.62	33.07		
5000	12.31	13.32	14.34	15.58	16.82	18.27	20.76	23.38	26.12	27.97	29.58	30.94	32.03	32.83			
5500	13.42	14.49	15.57	16.88	18.18	19.48	22.06	24.81	27.68	29.58	31.06	32.21	33.01				
6000	14.49	15.61	16.74	18.10	19.46	20.79	23.21	26.06	29.03	30.94	32.21	33.07					

CONTI SYNCHROBELT® HTD

Synchronous Drive Belt 8M 50 mm Belt Width Power Rating P_R (kW)

Table 41

Speed of small toothed pulley n _x r.p.m.	No. of teeth of small toothed pulley z _x																
	22	24	26	28	30	32	34	36	38	40	44	48	52	56	64	72	80
	Pitch Ø d _w (mm)																
	56.02	61.12	66.21	71.30	76.39	81.49	86.58	91.67	96.77	101.86	112.05	122.23	132.42	142.60	162.97	183.35	203.72
10	0.04	0.05	0.06	0.07	0.08	0.10	0.11	0.13	0.14	0.15	0.17	0.18	0.20	0.21	0.24	0.26	0.29
20	0.09	0.11	0.12	0.14	0.17	0.20	0.22	0.25	0.29	0.31	0.34	0.37	0.39	0.42	0.47	0.53	0.58
50	0.22	0.25	0.30	0.36	0.42	0.49	0.56	0.64	0.72	0.77	0.84	0.91	0.98	1.05	1.18	1.32	1.45
100	0.45	0.50	0.61	0.72	0.85	0.98	1.12	1.27	1.43	1.54	1.69	1.83	1.96	2.10	2.37	2.63	2.90
200	0.89	1.01	1.22	1.45	1.70	1.96	2.24	2.54	2.86	3.08	3.38	3.65	3.93	4.20	4.74	5.27	5.79
300	1.34	1.46	1.76	2.09	2.45	2.83	3.24	3.67	4.13	4.47	4.87	5.27	5.66	6.05	6.82	7.58	8.33
400	1.78	1.94	2.29	2.71	3.18	3.67	4.20	4.76	5.35	5.79	6.31	6.82	7.33	7.83	8.82	9.80	10.76
500	2.22	2.43	2.80	3.32	3.88	4.49	5.13	5.81	6.84	7.07	7.70	8.33	8.94	9.55	10.76	11.94	13.11
600	2.67	2.91	3.29	3.91	4.57	5.28	6.04	6.85	7.70	8.33	9.07	9.80	10.52	11.24	12.64	14.03	15.39
700	3.11	3.40	3.78	4.49	5.25	6.07	6.93	7.86	8.83	9.55	10.40	11.24	12.06	12.88	14.49	16.06	17.61
800	3.56	3.88	4.26	5.06	5.92	6.83	7.81	8.85	9.95	10.76	11.71	12.64	13.57	14.49	16.28	18.05	19.77
950	4.22	4.61	5.00	5.90	6.89	7.96	9.10	10.31	11.58	12.53	13.63	14.71	15.78	16.84	18.91	20.94	22.92
1000	4.44	4.85	5.26	6.17	7.21	8.33	9.52	10.79	12.12	13.11	14.26	15.39	16.51	17.61	19.77	21.88	23.94
1200	5.33	5.81	6.31	7.25	8.48	9.79	11.19	12.67	14.23	15.39	16.73	18.05	19.34	20.62	23.13	25.55	27.91
1450	6.43	7.01	7.61	8.57	10.01	11.56	13.21	14.95	16.80	18.16	19.72	21.26	22.76	24.25	27.13	29.92	32.60
1600	7.09	7.73	8.39	9.34	10.92	12.60	14.39	16.29	18.30	19.77	21.47	23.13	24.75	26.35	29.45	32.42	35.26
1800	7.97	8.69	9.43	10.35	12.09	13.96	15.94	18.04	20.26	21.88	23.74	25.55	27.33	29.07	32.42	35.60	38.63
2000	8.85	9.64	10.46	11.44	13.25	15.28	17.45	19.75	22.17	23.94	25.95	27.91	29.82	31.69	35.26	38.63	41.78
2200	9.72	10.58	11.48	12.56	14.37	16.58	18.93	21.41	24.04	25.95	28.11	30.20	32.23	34.21	37.97	41.47	44.71
2500	11.02	11.99	13.01	14.22	16.02	18.48	21.08	23.85	26.76	28.87	31.22	33.50	35.69	37.80	41.78	45.40	48.66
2850	12.52	13.62	14.76	16.13	17.88	20.61	23.51	26.57	29.81	32.14	34.69	37.14	39.48	41.70	45.81	49.44	52.54
3000	13.16	14.32	15.51	16.94	18.65	21.50	24.51	27.71	31.07	33.50	36.12	38.63	41.01	43.27	47.40	50.97	53.94
3500	15.27	16.60	17.96	19.60	21.26	24.34	27.74	31.33	35.11	37.80	40.62	43.27	45.75	48.04	52.03	55.19	57.43
4000	17.34	18.83	20.35	22.17	24.02	27.00	30.75	34.70	38.85	41.78	44.71	47.40	49.85	52.03	55.57	57.89	
4500	19.38	21.00	22.66	24.66	26.68	29.48	33.54	37.81	42.29	45.40	48.35	50.97	53.26	55.19	57.89		
5000	21.36	23.11	24.90	27.05	29.21	31.75	36.08	40.64	45.41	48.66	51.51	53.94	55.93	57.43			
5500	23.29	25.15	27.05	29.32	31.60	33.88	38.38	43.17	48.18	51.51	54.16	55.27	57.79				
6000	25.15	27.12	29.10	31.48	33.85	36.20	40.41	45.39	50.58	53.94	56.27	57.89					

CONTI SYNCHROBELT® HTD

Synchronous Drive Belt 8M 85 mm Belt Width Power Rating P_R (kW)

Table 42

Speed of small toothed pulley n_k (min ⁻¹)	No. of teeth of small toothed pulley z_k														
	32	34	36	38	40	44	48	52	56	60	64	68	72	76	80
	Pitch $\varnothing d_w$ (mm)														
	81.49	86.58	91.67	96.77	101.86	112.05	122.23	132.42	142.60	152.79	162.97	173.16	183.35	193.53	203.72
10	0.17	0.20	0.22	0.25	0.27	0.29	0.32	0.34	0.37	0.39	0.41	0.44	0.46	0.48	0.50
20	0.34	0.39	0.44	0.50	0.54	0.59	0.64	0.68	0.73	0.78	0.82	0.87	0.92	0.96	1.01
50	0.85	0.98	1.11	1.24	1.34	1.47	1.59	1.71	1.83	1.94	2.06	2.18	2.29	2.40	2.52
100	1.70	1.95	2.21	2.49	2.68	2.94	3.18	3.42	3.65	3.89	4.12	4.35	4.58	4.81	5.04
200	3.41	3.90	4.42	4.98	5.36	5.87	6.35	6.83	7.30	7.77	8.24	8.70	9.16	9.62	10.07
300	4.93	5.63	6.39	7.18	7.77	8.47	9.16	9.85	10.52	11.20	11.86	12.53	13.18	13.84	14.49
400	6.39	7.30	8.28	9.31	10.07	10.97	11.86	12.75	13.62	14.43	15.35	16.20	17.04	17.88	18.72
500	7.80	8.93	10.12	11.37	12.31	13.40	14.49	15.56	16.62	17.67	18.72	19.75	20.78	21.79	22.80
600	9.19	10.51	11.91	13.39	14.49	15.77	17.04	18.30	19.54	20.78	22.00	23.21	24.41	25.59	26.77
700	10.55	12.06	13.67	15.36	16.62	18.09	19.54	20.98	22.40	23.81	25.20	26.58	27.94	29.30	30.64
800	11.89	13.59	15.39	17.30	18.72	20.37	22.00	23.61	25.20	26.77	28.33	29.87	31.40	32.91	34.40
950	13.85	15.83	17.93	20.15	21.79	23.71	26.59	27.46	29.30	31.11	32.91	34.68	36.43	38.17	39.88
1000	14.49	16.57	18.76	21.09	22.80	24.80	26.77	28.72	30.64	32.53	34.40	36.25	38.08	39.88	41.66
1200	17.03	19.46	22.04	24.76	26.77	29.10	31.40	33.66	35.88	38.08	40.24	42.37	44.47	46.54	48.58
1450	20.11	22.98	26.02	29.22	31.69	34.31	36.98	39.61	42.19	44.73	47.22	49.67	52.07	54.43	56.74
1600	21.92	25.04	28.34	31.83	34.40	37.35	40.24	43.07	45.88	48.58	51.25	53.87	56.43	58.94	61.39
1800	24.28	27.73	31.38	35.24	38.08	41.31	44.47	47.56	50.59	53.54	56.43	59.25	61.99	64.67	67.27
2000	26.59	30.36	34.36	38.57	41.66	45.16	48.58	51.91	55.15	58.31	61.39	64.37	67.27	70.07	72.78
2200	28.85	32.94	37.26	41.83	45.16	48.91	52.56	56.11	59.55	62.89	66.12	69.24	72.25	75.14	77.92
2500	32.15	36.69	41.50	46.57	50.25	54.35	58.31	62.14	65.83	69.38	72.78	76.04	79.14	82.08	84.85
2850	35.87	40.91	46.25	51.88	55.95	60.40	64.67	68.75	72.65	76.35	79.86	83.15	86.23	89.08	91.70
3000	37.41	42.67	48.23	54.09	58.31	62.89	67.27	71.44	75.40	79.14	82.64	85.91	88.94	91.70	94.20
3500	42.38	48.30	54.55	61.13	65.83	70.76	75.40	79.74	83.76	87.46	90.81	93.81	96.43	98.66	100.49
4000	47.03	53.56	60.44	67.68	72.78	77.92	82.64	86.95	90.81	94.20	97.11	99.49	101.34		
4500	51.36	58.43	65.88	73.70	79.14	84.31	88.94	92.99	96.43	99.22	101.34				
5000	55.34	62.90	70.85	79.17	84.85	89.89	94.20	97.75	100.49	102.36					
5500	59.08	66.94	75.31	84.05	89.89	94.59	98.37	101.14							
6000	63.15	70.53	79.23	88.30	94.20	98.37	101.34								

CONTI SYNCHROBELT® HTD

Synchronous Drive Belt 14M 40 mm Belt Width Power Rating P_R (kW)

Table 43

Speed of small toothed pulley n_x r.p.m.	No. of teeth of small toothed pulley z_x																
	28	29	30	32	34	36	38	40	42	44	46	48	52	56	64	72	80
	Pitch $\varnothing d_w$ (mm)																
	124.78	129.23	133.69	142.60	151.52	160.43	169.34	178.25	187.17	196.08	204.99	213.90	231.73	249.55	285.21	320.86	356.51
10	0.2	0.2	0.2	0.2	0.3	0.3	0.3	0.4	0.4	0.4	0.4	0.4	0.5	0.5	0.6	0.7	0.7
20	0.4	0.4	0.4	0.5	0.6	0.6	0.7	0.7	0.8	0.8	0.8	0.9	1.0	1.0	1.2	1.3	1.5
40	0.7	0.8	0.8	1.0	1.1	1.2	1.4	1.4	1.5	1.6	1.7	1.8	1.9	2.1	2.4	2.7	3.0
60	1.1	1.2	1.3	1.5	1.7	1.9	2.0	2.2	2.3	2.4	2.5	2.7	2.9	3.1	3.6	4.0	4.5
100	1.8	1.9	2.1	2.4	2.8	3.1	3.4	3.6	3.8	4.0	4.2	4.4	4.9	5.2	6.0	6.7	7.5
200	3.6	3.9	4.2	4.8	5.5	6.2	6.8	7.2	7.6	8.0	8.4	8.9	9.7	10.5	12.0	13.5	15.0
300	4.9	5.3	5.7	6.6	7.5	8.5	9.2	9.7	10.3	10.8	11.4	12.0	13.1	14.2	16.5	18.9	21.3
400	6.1	6.6	7.1	8.2	9.3	10.5	11.4	12.0	12.7	13.3	14.0	14.7	16.0	17.4	20.1	22.9	25.8
500	7.2	7.8	8.4	9.6	11.0	12.3	13.3	14.1	14.8	15.6	16.4	17.2	18.7	20.2	23.3	26.4	29.6
600	8.2	8.9	9.5	11.0	12.5	14.0	15.1	15.9	16.8	17.6	18.5	19.4	21.1	22.7	26.1	29.5	32.9
700	9.1	9.9	10.6	12.2	13.8	15.6	16.8	17.7	18.6	19.5	20.5	21.4	23.2	25.0	28.5	32.1	36.7
800	10.0	10.8	11.6	13.3	15.1	17.0	18.3	19.3	20.2	21.2	22.2	23.2	25.1	27.0	30.7	34.5	38.1
950	11.2	12.1	13.0	14.9	16.9	19.0	20.4	21.4	22.5	23.5	24.6	25.7	27.7	29.7	33.5	37.3	41.0
1000	11.6	12.5	13.5	15.4	17.5	19.6	21.0	22.1	23.2	24.3	25.3	26.4	28.5	30.4	34.3	38.1	41.7
1200	13.0	14.1	15.1	17.3	19.5	21.8	23.4	24.5	25.6	26.8	27.9	29.0	31.1	33.1	37.0	40.5	43.8
1450	14.6	15.7	16.9	19.2	21.7	24.2	25.8	27.0	28.2	29.3	30.5	31.6	33.6	35.6	38.9	41.8	44.2
1600	15.4	16.6	17.8	20.2	22.8	25.4	27.1	28.2	29.4	30.5	31.6	32.7	34.7	36.4	39.4	41.7	43.3
1800	16.4	17.6	18.9	21.4	24.0	26.8	28.4	29.6	30.7	31.8	32.8	33.8	35.5	37.0	39.2	40.5	40.7
2000	17.2	18.5	19.8	22.4	25.1	27.9	29.5	30.6	31.6	32.6	33.5	34.4	35.8	36.9	38.1	38.0	36.5
2200	18.5	19.2	20.5	23.2	25.9	28.7	30.3	31.3	32.2	33.1	33.8	34.5	35.5	36.1	36.0	34.2	
2400	20.0	20.6	21.1	23.8	26.5	29.3	30.8	31.7	32.4	33.1	33.7	34.1	34.6	34.5	32.9		
2600	21.3	21.9	22.5	24.2	26.9	29.6	31.0	31.7	32.3	32.7	33.0	33.2	33.1	32.2	29.2		
2850	22.9	23.6	24.1	25.3	27.1	29.7	30.8	31.2	31.5	31.6	31.6	31.4	30.5	29.9			
3000	23.8	24.5	25.0	26.2	27.2	29.5	30.5	30.7	30.8	30.6	30.5	30.6	30.2	29.1			
3500	26.5	27.1	27.6	28.6	29.3	29.9	30.3	30.5	30.5	30.3	29.8	29.1					
4000	28.6	29.0	29.4	30.1	30.4	30.6	30.4	29.9	29.1								

CONTI SYNCHROBELT® HTD

Synchronous Drive Belt 14M 55 mm Belt Width Power Rating P_R (kW)

Table 44

Speed of small toothed pulley n_x r.p.m.	No. of teeth of small toothed pulley z_x																
	28	29	30	32	34	36	38	40	42	44	46	48	52	56	64	72	80
	Pitch $\varnothing d_w$ (mm)																
	124.78	129.23	133.69	142.60	151.52	160.43	169.34	178.25	187.17	196.08	204.99	213.90	231.73	249.55	285.21	320.86	356.51
10	0.3	0.3	0.3	0.4	0.4	0.5	0.5	0.5	0.6	0.6	0.6	0.7	0.7	0.8	0.9	1.0	1.1
20	0.5	0.6	0.6	0.7	0.8	0.9	1.0	1.1	1.1	1.2	1.3	1.3	1.4	1.6	1.8	2.0	2.2
40	1.1	1.2	1.3	1.4	1.6	1.9	2.0	2.1	2.3	2.4	2.5	2.6	2.9	3.1	3.6	4.0	4.5
60	1.6	1.7	1.9	2.2	2.5	2.8	3.0	3.2	3.4	3.6	3.8	4.0	4.3	4.7	5.4	6.0	6.7
100	2.7	2.9	3.1	3.6	4.1	4.7	5.0	5.3	5.7	6.0	6.3	6.6	7.2	7.8	8.9	10.1	11.2
200	5.4	5.8	6.3	7.2	8.2	9.3	10.1	10.7	11.3	11.9	12.6	13.2	14.5	15.7	17.9	20.1	22.3
300	7.3	7.9	8.6	9.9	11.2	12.7	13.7	14.5	15.3	16.2	17.0	17.9	19.5	21.2	24.6	28.1	31.8
400	9.1	9.9	10.6	12.2	13.9	15.7	16.9	17.9	18.9	19.9	20.9	22.0	24.0	25.9	30.0	34.2	38.4
500	10.7	11.6	12.5	14.4	16.4	18.4	19.9	21.0	22.1	23.3	24.4	25.6	27.9	30.1	34.7	39.4	44.2
600	12.2	13.2	14.2	16.4	18.6	20.9	22.5	23.8	25.1	26.3	27.6	28.9	31.4	33.9	38.9	44.0	49.1
700	13.6	14.7	15.9	18.2	20.7	23.2	25.0	26.4	27.8	29.1	30.6	31.9	34.6	37.3	42.7	48.0	53.4
800	15.0	16.2	17.4	19.9	22.6	25.4	22.3	28.8	30.2	31.7	33.2	34.7	37.5	40.4	45.9	51.5	57.1
950	16.8	18.1	19.5	22.3	25.3	28.3	30.4	32.0	33.6	35.2	36.8	38.4	41.4	44.4	50.2	56.9	61.4
1000	17.4	18.7	20.1	23.0	26.1	29.2	31.4	33.0	34.6	36.2	37.9	39.5	42.6	45.5	51.4	57.1	62.6
1200	19.5	21.0	22.6	25.8	29.1	32.6	34.9	36.6	38.4	40.1	41.8	43.4	46.6	49.6	55.4	60.8	65.9
1450	21.8	23.5	25.2	28.7	32.4	36.2	38.6	40.4	42.2	43.9	45.6	47.3	50.4	53.3	58.6	63.1	66.9
1600	23.1	24.8	26.6	30.3	34.1	38.0	40.5	42.3	44.0	45.8	47.4	49.1	52.1	54.7	59.4	63.2	65.9
1800	24.5	26.4	28.2	32.1	36.0	40.1	42.6	44.4	46.1	47.7	49.3	50.8	53.5	55.8	59.5	61.8	62.6
2000	25.8	27.7	29.6	33.6	37.6	41.8	44.3	46.0	47.6	49.1	50.5	51.9	54.1	55.9	58.1	58.6	57.0
2200	27.8	28.8	30.8	34.8	38.9	43.1	45.6	47.1	48.5	49.9	51.1	52.2	53.9	55.0	55.4	53.5	
2400	30.0	30.9	31.8	35.8	39.9	44.1	46.4	47.8	49.0	50.1	51.1	51.9	52.8	53.0	51.3		
2600	32.1	33.0	33.9	36.5	40.6	44.7	46.9	48.0	48.9	49.7	50.3	50.8	50.8	50.0	46.5		
2850	34.5	35.5	36.4	38.2	41.0	44.9	46.8	47.5	48.1	48.4	48.6	48.4	47.5	47.1			
3000	35.9	36.9	37.8	39.6	41.2	44.8	46.4	46.9	47.1	47.1	47.1	47.4	47.3	46.3			
3500	40.1	41.0	41.9	43.5	44.8	45.9	46.7	47.2	47.5	47.4	47.0	46.3					
4000	43.5	44.3	45.0	46.2	47.0	47.4	47.5	47.1	46.3								

CONTI SYNCHROBELT® HTD

Synchronous Drive Belt 14M 85 mm Belt Width Power Rating P_R (kW)

Table 45

Speed of small toothed pulley n_x r.p.m.	No. of teeth of small toothed pulley z_x																
	28	29	30	32	34	36	38	40	42	44	46	48	52	56	64	72	80
	Pitch $\varnothing d_w$ (mm)																
	124.78	129.23	133.69	142.60	151.52	160.43	169.34	178.25	187.17	196.08	204.99	213.90	231.73	249.55	285.21	320.86	356.51
10	0.4	0.5	0.5	0.6	0.7	0.8	0.8	0.9	0.9	1.0	1.0	1.1	1.2	1.3	1.5	1.7	1.9
20	0.9	1.0	1.0	1.2	1.4	1.5	1.7	1.8	1.9	2.0	2.1	2.2	2.4	2.6	3.0	3.3	3.7
40	1.8	1.9	2.1	2.4	2.7	3.1	3.3	3.6	3.8	4.0	4.2	4.4	4.8	5.2	5.9	6.7	7.4
60	2.7	2.9	3.1	3.6	4.1	4.6	5.0	5.3	5.6	5.5	6.3	6.6	7.2	7.8	8.9	10.0	11.1
100	4.4	4.8	5.2	6.0	6.8	7.7	8.4	8.9	9.4	9.9	10.4	11.0	12.0	13.0	14.9	16.7	18.6
200	8.9	9.6	10.4	12.0	13.7	15.5	16.7	17.7	18.8	19.8	20.9	21.9	24.0	26.0	29.7	33.4	37.1
300	12.2	13.2	14.2	16.4	18.7	21.1	22.8	24.1	25.5	26.9	28.3	29.7	32.4	35.2	40.9	46.7	52.8
400	15.1	16.4	17.6	20.3	23.1	26.1	28.1	29.7	31.4	33.1	34.7	36.4	39.8	43.1	49.8	56.7	63.8
500	17.8	19.3	20.8	23.9	27.1	30.6	33.0	34.8	36.7	38.6	40.6	42.5	46.3	50.0	57.7	65.5	73.4
600	20.3	22.0	23.7	27.2	30.9	34.7	37.4	39.5	41.6	43.7	45.9	48.0	52.2	56.3	64.7	73.1	81.7
700	22.7	24.6	26.3	30.2	34.3	38.6	41.8	43.8	46.1	48.4	50.7	53.0	57.5	62.0	70.9	79.8	88.8
800	24.8	26.8	28.9	33.1	37.5	42.2	45.3	47.8	50.2	52.7	55.1	57.6	62.4	67.0	76.4	85.7	94.9
950	27.9	30.1	32.3	37.0	41.9	47.1	60.6	53.2	56.8	58.6	61.1	63.8	68.8	73.7	83.4	93.0	102.3
1000	28.8	31.1	33.4	38.3	43.3	48.6	52.1	54.8	57.5	60.2	62.9	65.6	70.8	75.7	85.5	95.0	104.3
1200	32.4	34.9	37.5	42.8	48.4	54.2	58.0	60.9	63.8	66.6	69.4	72.3	77.6	82.6	92.3	101.5	110.0
1450	36.3	39.1	41.9	47.8	53.8	60.1	64.2	67.2	70.2	73.1	76.0	78.8	84.0	88.9	97.8	105.7	112.4
1600	38.3	41.3	44.2	50.3	56.7	63.2	67.4	70.4	73.3	76.2	79.1	81.9	86.9	91.4	99.5	106.2	111.1
1800	40.8	43.9	47.0	53.4	60.0	66.7	71.0	73.9	76.8	79.6	82.3	84.9	89.5	93.5	99.9	104.3	106.4
2000	43.0	46.1	49.3	55.9	62.7	69.7	73.9	76.7	79.4	82.0	84.5	86.9	90.8	93.9	98.2	99.7	97.9
2200	46.3	48.1	51.3	58.1	65.0	72.0	76.1	78.7	81.2	83.5	85.7	87.7	90.7	92.8	94.3	92.0	
2400	50.0	51.5	53.0	59.8	66.7	73.7	77.7	80.0	82.2	84.1	85.8	87.4	89.3	90.0	88.1		
2600	53.5	55.1	56.7	61.1	67.9	74.8	78.5	80.5	82.3	83.7	85.0	85.9	86.4	85.5	80.9		
2850	57.7	69.4	61.0	64.0	68.7	76.4	78.7	80.1	81.2	81.9	82.3	82.4	81.5	81.5			
3000	60.1	51.8	63.4	66.4	69.2	75.3	78.3	79.3	79.9	80.1	80.4	81.2	81.7	80.7			
3500	67.4	69.0	70.5	73.3	75.8	77.8	79.5	80.7	81.4	81.7	81.4	80.7					
4000	73.3	74.8	76.1	78.3	80.0	81.2	81.7	81.5	80.7								

CONTI SYNCHROBELT® HTD

Synchronous Drive Belt 14M 115 mm Belt Width Power Rating P_R (kW)

Table 46

Speed of small toothed pulley n_x r.p.m.	No. of teeth of small toothed pulley z_x																
	28	29	30	32	34	36	38	40	42	44	46	48	52	56	64	72	80
	Pitch $\varnothing d_w$ (mm)																
	124.78	129.23	133.69	142.60	151.52	160.43	169.34	178.25	187.17	196.08	204.99	213.90	231.73	249.55	285.21	320.86	356.51
10	0.6	0.7	0.7	0.8	1.0	1.1	1.2	1.2	1.3	1.4	1.5	1.5	1.7	1.8	2.1	2.3	2.6
20	1.2	1.3	1.5	1.7	1.9	2.2	2.3	2.5	2.6	2.8	2.9	3.1	3.4	3.6	4.2	4.7	5.2
40	2.5	2.7	2.9	3.4	3.8	4.3	4.7	5.0	5.2	5.5	5.8	6.1	6.7	7.3	8.3	9.3	10.4
60	3.7	4.0	4.4	5.0	5.7	6.5	7.0	7.4	7.9	8.3	8.8	9.2	10.1	10.9	12.5	14.0	15.6
100	6.2	6.7	7.3	8.4	9.6	10.8	11.7	12.4	13.1	13.8	14.6	15.3	16.8	18.2	20.8	23.3	25.9
200	12.4	13.5	14.5	16.8	19.1	21.6	23.4	24.8	26.2	27.7	29.2	30.7	33.6	36.3	41.5	46.7	51.8
300	17.0	18.4	19.9	22.9	26.1	29.4	31.8	33.7	35.6	37.5	39.5	41.5	45.3	49.2	57.1	65.3	73.7
400	21.1	22.9	24.6	28.4	32.3	36.4	39.3	41.6	43.9	46.2	48.6	50.9	55.6	60.2	69.6	79.3	89.2
500	24.9	26.9	29.0	33.4	37.9	42.7	46.1	48.7	51.3	54.0	56.7	59.4	64.7	70.0	80.6	91.5	102.6
600	28.4	30.7	33.1	38.0	43.1	48.5	52.3	55.2	58.2	61.1	64.1	67.1	73.0	78.7	90.4	102.2	114.2
700	31.7	34.2	36.8	42.3	48.0	53.9	58.0	61.2	64.4	67.6	70.9	74.1	80.4	86.6	99.1	111.6	124.2
800	34.7	37.5	40.3	46.2	52.4	58.9	63.4	66.8	70.2	73.6	77.1	80.6	87.2	93.7	106.8	119.8	132.7
950	39.0	42.1	45.2	51.8	58.6	65.8	70.6	74.3	78.0	81.7	85.4	89.1	96.2	103.1	116.7	130.1	143.1
1000	40.3	43.5	46.7	53.5	60.6	67.9	72.9	76.7	80.4	84.2	88.0	91.8	98.9	105.9	119.6	133.0	146.0
1200	45.3	48.8	52.4	59.9	67.7	75.7	81.1	85.2	89.2	93.1	97.1	101.1	108.5	115.6	129.3	142.2	154.2
1450	50.7	54.6	58.6	66.8	75.3	84.1	89.9	94.0	98.2	102.3	106.3	110.3	117.6	124.5	137.1	148.3	157.8
1600	53.6	57.7	61.8	70.4	79.3	88.4	94.3	98.5	102.6	106.7	110.7	114.6	121.7	128.1	139.6	149.1	156.3
1800	57.1	61.4	65.7	74.7	83.9	93.4	99.4	103.5	107.6	111.5	115.3	119.0	125.5	131.1	140.4	146.9	150.1
2000	60.1	64.6	69.1	78.3	87.8	97.5	103.5	107.5	111.3	115.0	118.5	121.8	127.4	131.9	138.3	140.7	138.8
2200	64.8	67.3	71.9	81.3	91.0	100.8	106.7	110.4	113.9	117.2	120.3	123.1	127.5	130.5	133.1	130.6	
2400	70.0	72.2	74.3	83.8	93.5	103.3	108.9	112.3	115.3	118.1	120.6	122.8	125.7	126.9	124.9		
2600	75.0	77.2	79.4	85.6	95.3	105.0	110.2	113.1	115.6	117.8	119.6	121.0	122.0	121.0	115.3		
2850	80.9	83.2	85.5	89.8	96.5	105.9	110.6	112.7	114.3	115.5	116.2	116.4	115.5	116.0			
3000	84.3	86.6	88.9	93.2	97.2	105.9	110.1	111.6	112.6	113.1	113.6	114.9	116.0	115.1			
3500	94.6	96.9	99.1	103.2	106.7	109.7	112.2	114.1	115.3	116.0	115.9	115.1					
4000	103.2	105.3	107.2	110.5	113.1	114.9	115.8	115.9	115.1								

CONTI SYNCHROBELT® HTD

Synchronous Drive Belt 14M 170 mm Belt Width Power Rating P_R (kW)

Table 47

Speed of small toothed pulley n_x r.p.m.	No. of teeth of small toothed pulley z_x														
	36	38	40	42	44	46	48	52	56	60	64	68	72	76	80
	Pitch $\varnothing d_w$ (mm)														
	160.43	169.34	178.25	187.17	196.08	204.99	213.90	231.73	249.55	267.38	285.21	303.03	320.86	338.68	356.51
10	1.6	1.8	1.9	2.0	2.1	2.2	2.3	2.6	2.8	3.0	3.2	3.4	3.6	3.8	3.9
20	3.3	3.6	3.8	4.0	4.2	4.4	4.7	5.1	5.5	5.9	6.3	6.7	7.1	7.5	7.9
40	6.6	7.1	7.5	8.0	8.4	8.9	9.3	10.2	11.1	11.8	12.6	13.4	14.2	15.0	15.8
60	9.9	10.7	11.3	12.0	12.6	13.3	14.0	15.3	16.6	17.8	18.9	20.1	21.3	22.5	23.7
100	16.4	17.8	18.9	20.0	21.1	22.2	23.3	25.6	27.6	29.6	31.6	33.5	35.5	37.5	39.5
200	32.9	35.6	37.7	39.9	42.1	44.4	46.7	51.1	55.2	59.2	63.1	67.1	71.0	74.9	78.9
300	44.8	48.4	51.3	54.2	57.1	60.1	63.1	69.0	74.8	80.8	86.9	93.1	99.3	105.7	112.2
400	55.4	59.8	63.3	66.8	70.3	73.9	77.5	84.5	91.6	98.7	105.9	113.2	120.7	128.2	135.8
500	65.0	70.1	74.1	78.1	82.2	86.3	90.4	98.5	106.4	114.5	122.7	130.9	139.2	147.6	156.1
600	73.9	79.6	84.0	88.5	93.0	97.6	102.2	111.0	119.8	128.6	137.5	146.5	155.5	164.6	173.8
700	82.1	88.3	93.1	98.0	102.9	107.9	112.8	122.4	131.8	147.3	150.8	160.3	169.9	179.4	189.0
800	89.7	96.4	101.6	106.8	112.0	117.3	122.6	132.7	142.7	152.6	162.6	172.5	182.4	192.3	202.1
950	100.1	107.5	113.1	118.7	124.4	130.0	135.7	146.5	157.0	167.4	177.7	188.0	198.1	208.2	218.0
1000	103.4	110.9	116.7	122.4	128.2	133.9	139.7	150.6	161.2	171.8	182.2	192.5	202.6	212.6	222.4
1200	115.3	123.5	129.6	135.7	141.8	147.9	153.9	165.2	176.1	186.6	197.0	207.0	216.7	226.1	235.2
1450	128.1	136.8	143.2	149.5	155.8	161.9	168.0	179.2	189.7	199.7	209.1	218.0	226.3	234.0	241.1
1600	134.7	143.6	150.0	156.4	162.6	168.7	174.7	185.5	195.4	204.6	213.1	220.9	227.9	234.0	239.2
1800	142.3	151.4	157.7	163.9	169.9	175.8	181.5	191.4	200.1	207.9	214.7	220.3	224.9	228.2	230.3
2000	148.6	157.7	163.8	169.7	175.4	180.8	185.9	194.6	201.6	207.4	211.8	214.7	216.1	215.8	213.9
2200	153.7	162.7	168.4	173.8	178.9	183.6	188.1	194.9	199.8	203.0	204.4	203.8	201.3	196.5	
2400	157.6	166.2	171.4	176.1	180.5	184.4	187.9	192.5	194.7	194.7	192.4	187.6			
2600	160.3	168.4	172.8	176.7	180.1	183.0	185.3	187.2	186.1	182.3	178.5				
2850	161.9	169.1	172.4	175.0	177.0	178.2	178.7	177.8	179.1	177.5					
3000	161.9	168.5	170.9	172.7	173.6	174.6	176.7	179.0	178.2						
3500	168.3	172.2	175.4	177.6	178.8	179.0	178.2								
4000	176.7	178.5	179.1	178.2											

Centre Distance Factors

With the aid of table 52, it is possible to calculate the centre distance factors as follows,

- the exact centre distance at a given synchronous drive belt length
- or
- the exact synchronous drive belt length at a given centre distance.

The method is explained by an example in the chapter "Design Data", in the sections of "Centre Distance a" and "Pitch Length L_w " (page 41, page 42) .

Centre Distance Factors

Table 48

$z_g - z_k$	$z - z_k$	4	5	6	7	8	9	10	11	12	13	14	15	16
1	1.743		2.244	2.745	3.246	3.747	4.247	4.747	5.248	5.748	6.248	6.748	7.248	7.748
2	1.465		1.974	2.480	2.983	3.485	3.987	4.489	4.990	5.491	5.992	6.492	6.993	7.493
3	1.149		1.682	2.198	2.708	3.214	3.719	4.223	4.726	5.228	5.730	6.232	6.733	7.234
4			1.346	1.892	2.416	2.931	3.441	3.949	4.454	4.959	5.463	5.966	6.469	6.971
5				1.539	2.097	2.629	3.149	3.663	4.174	4.682	5.189	5.694	6.199	6.703
6					1.729	2.299	2.838	3.364	3.882	4.396	4.907	5.416	5.923	6.429
7						1.916	2.497	3.044	3.575	4.098	4.615	5.128	5.640	6.149
8							2.101	2.693	3.247	3.784	4.311	4.831	5.348	5.861
9								2.284	2.887	3.448	3.990	4.521	5.045	5.565
10									2.466	3.079	3.647	4.194	4.730	5.257
11										2.646	3.269	3.844	4.397	4.936
12											2.826	3.458	4.039	4.597
13												3.004	3.645	4.234
14													3.182	3.832
15														3.359

Centre Distance Factors

Table 48

$z_g - z_k$	$z - z_k$	17	18	19	20	21	22	23	24	25	26	27	28	29
1	8.248	8.749	9.249	9.749	10.249	10.749	11.249	11.749	12.249	12.749	13.249	13.749	14.249	14.749
2	7.994	8.494	8.994	9.495	9.995	10.495	10.995	11.496	11.996	12.496	12.996	13.496	13.996	14.496
3	7.735	8.236	8.737	9.238	9.738	10.239	10.739	11.240	11.740	12.241	12.741	13.241	13.742	14.242
4	7.473	7.975	8.476	8.977	9.479	9.980	10.481	10.982	11.482	11.983	12.484	12.984	13.485	13.985
5	7.206	7.709	8.211	8.714	9.216	9.717	10.219	10.720	11.222	11.723	12.224	12.725	13.226	13.726
6	6.934	7.439	7.943	8.446	8.949	9.452	9.954	10.456	10.958	11.460	11.962	12.463	12.965	13.465
7	6.657	7.163	7.669	8.174	8.678	9.182	9.686	10.189	10.692	11.195	11.697	12.199	12.701	13.201
8	6.372	6.882	7.390	7.897	8.403	8.909	9.414	9.918	10.422	10.926	11.429	11.932	12.435	12.935
9	6.080	6.594	7.105	7.615	8.123	8.631	9.137	9.643	10.149	10.654	11.158	11.662	12.166	12.666
10	5.779	6.298	6.813	7.326	7.838	8.348	8.857	9.364	9.871	10.378	10.883	11.389	11.893	12.393
11	5.467	5.992	6.513	7.031	7.546	8.059	8.571	9.081	9.590	10.098	10.605	11.112	11.618	12.121
12	5.141	5.676	6.204	6.727	7.247	7.764	8.279	8.792	9.303	9.814	10.323	10.831	11.339	11.842
13	4.796	5.344	5.882	6.413	6.939	7.461	7.980	8.497	9.011	9.524	10.036	10.546	11.056	11.561
14	4.426	4.994	5.546	6.087	6.621	7.150	7.674	8.195	8.714	9.230	9.744	10.257	10.769	11.276
15	4.017	4.618	5.191	5.747	6.291	6.828	7.359	7.886	8.409	8.929	9.447	9.963	10.477	10.986
16	3.535	4.202	4.808	5.386	5.946	6.494	7.034	7.567	8.096	8.621	9.143	9.662	10.180	10.694
17		3.710	4.385	4.998	5.580	6.144	6.695	7.238	7.774	8.305	8.832	9.356	9.877	10.393
18			3.885	4.568	5.187	5.773	6.341	6.896	7.441	7.980	8.513	9.042	9.568	10.091
19				4.060	4.750	5.374	5.966	6.537	7.095	7.644	8.185	8.720	9.251	9.778
20					4.234	4.931	5.561	6.157	6.732	7.294	7.845	8.388	8.926	9.459
21						4.408	5.112	5.748	6.348	6.927	7.491	8.045	8.591	9.129
22							4.581	5.293	5.933	6.538	7.120	7.688	8.245	8.793
23								4.754	5.472	6.118	6.727	7.313	7.884	8.441
24									4.926	5.651	6.302	6.915	7.505	8.072
25										5.098	5.830	6.486	7.103	7.691
26											5.270	6.008	6.669	7.276
27												5.441	6.186	6.841
28													5.612	6.286
29														6.386
30														6.486

Centre Distance Factors

Table 48

$z_g - z_k$	$z - z_k$	30	31	32	33	34	35	36	37	38	39	40	41	42
1	14.749	15.249	15.749	16.249	16.749	17.249	17.749	18.249	18.749	19.249	19.749	20.249	20.749	20.749
2	14.496	14.997	15.497	15.997	16.497	16.997	17.497	17.997	18.497	18.997	19.497	19.997	19.997	20.497
3	14.242	14.742	15.243	15.743	16.243	16.743	17.243	17.744	18.244	18.744	19.244	19.744	19.744	20.244
4	13.985	14.486	14.986	15.487	15.987	16.488	16.988	17.488	17.989	18.489	18.989	19.490	19.490	19.990
5	13.727	14.228	14.728	15.229	15.730	16.230	16.731	17.232	17.732	18.233	18.733	19.234	19.234	19.734
6	13.466	13.967	14.468	14.970	15.471	15.971	16.472	16.973	17.474	17.975	18.475	18.976	18.976	19.477
7	13.203	13.705	14.206	14.708	15.209	15.710	16.212	16.713	17.214	17.715	18.216	18.717	18.717	19.218
8	12.937	13.440	13.942	14.444	14.946	15.447	15.949	16.451	16.952	17.454	17.955	18.456	18.456	18.957
9	12.669	13.172	13.675	14.178	14.680	15.182	15.685	16.187	16.688	17.190	17.692	18.194	18.194	18.695
10	12.398	12.902	13.405	13.909	14.412	14.915	15.418	15.920	16.423	16.925	17.427	17.929	17.929	18.431
11	12.123	12.628	13.133	13.637	14.141	14.645	15.149	15.652	16.155	16.658	17.161	17.663	17.663	18.166
12	11.846	12.352	12.858	13.363	13.868	14.373	14.877	15.381	15.885	16.389	16.892	17.395	17.395	17.898
13	11.564	12.072	12.579	13.086	13.592	14.098	14.603	15.108	15.613	16.117	16.621	17.125	17.125	17.628
14	11.279	11.789	12.298	12.806	13.313	13.820	14.326	14.832	15.338	15.843	16.348	16.852	16.852	17.357
15	10.990	11.501	12.012	12.522	13.031	13.539	14.047	14.554	15.060	15.567	16.072	16.578	16.578	17.083
16	10.695	11.209	11.722	12.234	12.745	13.255	13.764	14.272	14.780	15.287	15.794	16.301	16.301	16.807
17	10.396	10.913	11.428	11.942	12.455	12.967	13.477	13.987	14.497	15.005	15.513	16.021	16.021	16.528
18	10.091	10.611	11.129	11.646	12.161	12.675	13.188	13.699	14.210	14.720	15.230	15.739	15.739	16.247
19	9.779	10.303	10.825	11.345	11.862	12.379	12.894	13.408	13.920	14.432	14.943	15.453	15.453	15.963
20	9.459	9.988	10.514	11.038	11.559	12.078	12.596	13.112	13.626	14.140	14.653	15.165	15.165	15.676
21	9.131	9.666	10.197	10.725	11.250	11.772	12.293	12.812	13.329	13.845	14.359	14.873	14.873	15.386
22	8.793	9.335	9.872	10.405	10.934	11.461	11.985	12.507	13.027	13.545	14.062	14.577	14.577	15.092
23	8.443	8.994	9.539	10.078	10.612	11.143	11.671	12.196	12.720	13.241	13.760	14.278	14.278	14.795
24	8.079	8.641	9.195	9.741	10.282	10.818	11.351	11.880	12.407	12.932	13.454	13.975	13.975	14.494
25	7.697	8.273	8.838	9.394	9.943	10.486	11.024	11.558	12.089	12.617	13.143	13.667	13.667	14.188
26	7.291	7.887	8.467	9.035	9.593	10.144	10.688	11.228	11.764	12.297	12.827	13.354	13.354	13.878
27	6.852	7.477	8.077	8.660	9.230	9.791	10.344	10.891	11.432	11.970	12.504	13.035	13.035	13.563
28	6.364	7.034	7.663	8.267	8.853	9.425	9.988	10.543	11.092	11.636	12.175	12.710	12.710	13.243
29	5.783	6.541	7.216	7.849	8.456	9.045	9.620	10.185	10.742	11.293	11.838	12.379	12.379	12.916
30		5.954	6.717	7.397	8.034	8.644	9.236	9.814	10.381	10.941	11.493	12.040	12.040	12.583
31			6.125	6.894	7.578	8.219	8.832	9.427	10.007	10.577	11.138	11.693	11.693	12.242
32				6.295	7.070	7.759	8.403	9.020	9.617	10.200	10.772	11.335	11.335	11.892
33					6.465	7.246	7.939	8.587	9.207	9.807	10.392	10.966	10.966	11.532
34						6.635	7.421	8.119	8.770	9.393	9.996	10.584	10.584	11.160
35							6.804	7.596	8.298	8.953	9.579	10.185	10.185	10.775
36								6.974	7.771	8.477	9.136	9.765	9.765	10.373
37									7.143	7.946	8.656	9.318	9.318	9.950
38										7.312	8.120	8.834	8.834	9.500
39											7.481	8.294	8.294	9.013
40												7.650	7.650	8.468
41														7.818
42														
43														
44														
45														

Centre Distance Factors

Table 48

$z_g - z_k$	$z - z_k$												
	43	44	45	46	47	48	49	50	51	52	53	54	55
1	21.249	21.749	22.249	22.749	23.249	23.749	24.249	24.749	25.249	25.749	26.249	26.749	27.249
2	20.998	21.498	21.998	22.498	22.998	23.498	23.998	24.498	24.998	25.498	25.998	26.498	26.998
3	20.744	21.245	21.745	22.245	22.745	23.245	23.745	24.245	24.745	25.245	25.746	26.246	26.746
4	20.490	20.990	21.491	21.991	22.491	22.991	23.491	23.992	24.492	24.992	25.492	25.992	26.492
5	20.234	20.735	21.235	21.735	22.236	22.736	23.236	23.737	24.237	24.737	25.237	25.738	26.238
6	19.977	20.478	20.978	21.479	21.979	22.480	22.980	23.481	23.981	24.481	24.982	25.482	25.982
7	19.719	20.219	20.720	21.221	21.721	22.222	22.723	23.223	23.724	24.224	24.725	25.225	25.726
8	19.458	19.959	20.460	20.961	21.462	21.963	22.464	22.965	23.465	23.966	24.467	24.967	25.468
9	19.196	19.698	20.199	20.700	21.202	21.703	22.204	22.705	23.206	23.707	24.208	24.708	25.209
10	18.933	19.435	19.936	20.438	20.939	21.441	21.942	22.444	22.945	23.446	23.947	24.448	24.949
11	18.668	19.170	19.672	20.174	20.676	21.178	21.679	22.181	22.682	23.184	23.685	24.187	24.688
12	18.401	18.903	19.406	19.908	20.411	20.913	21.415	21.917	22.419	22.920	23.422	23.924	24.425
13	18.132	18.635	19.138	19.641	20.144	20.646	21.149	21.651	22.153	22.655	23.157	23.659	24.161
14	17.861	18.365	18.868	19.372	19.875	20.378	20.881	21.384	21.886	22.389	22.891	23.394	23.896
15	17.588	18.092	18.597	19.101	19.604	20.108	20.612	21.115	21.618	22.121	22.624	23.127	23.629
16	17.312	17.818	18.323	18.827	19.332	19.836	20.340	20.844	21.348	21.851	22.355	22.858	23.361
17	17.035	17.541	18.047	18.552	19.058	19.563	20.067	20.572	21.076	21.580	22.084	22.588	23.091
18	16.754	17.262	17.769	18.275	18.781	19.287	19.792	20.297	20.802	21.507	21.812	22.316	22.820
19	16.472	16.980	17.488	17.995	18.502	19.009	19.515	20.021	20.527	21.032	21.537	22.042	22.547
20	16.186	16.696	17.205	17.713	18.221	18.729	19.236	19.743	20.249	20.755	21.261	21.767	22.272
21	15.897	16.408	16.919	17.428	17.938	18.446	18.955	19.462	19.970	20.477	20.983	21.490	21.996
22	15.606	16.118	16.630	17.141	17.652	18.161	18.671	19.179	19.688	20.196	20.703	21.210	21.717
23	15.310	15.825	16.338	16.851	17.363	17.874	18.384	18.894	19.404	19.913	20.421	20.929	21.437
24	15.011	15.528	16.043	16.557	17.071	17.583	18.095	18.607	19.117	19.627	20.137	20.646	21.154
25	14.708	15.227	15.745	16.261	16.776	17.290	17.803	18.316	18.828	19.339	19.850	20.360	20.870
26	14.401	14.922	15.442	15.961	16.478	16.994	17.509	18.023	18.536	19.049	19.561	20.072	20.583
27	14.089	14.614	15.136	15.656	16.176	16.694	17.211	17.727	18.241	18.755	19.269	19.781	20.293
28	13.773	14.300	14.825	15.348	15.870	16.390	16.909	17.427	17.944	18.459	18.974	19.488	20.001
29	13.450	13.981	14.510	15.036	15.560	16.083	16.604	17.124	17.643	18.160	18.677	19.192	19.707
30	13.121	13.657	14.189	14.719	15.246	15.772	16.295	16.818	17.338	17.858	18.376	18.893	19.410
31	12.786	13.326	13.862	14.396	14.927	15.456	15.982	16.507	17.030	17.552	18.072	18.591	19.109
32	12.442	12.988	13.530	14.068	14.602	15.135	15.665	16.192	16.718	17.242	17.765	18.286	18.806
33	12.090	12.642	13.190	13.733	14.272	14.808	15.342	15.873	16.402	16.929	17.454	17.977	18.499
34	11.728	12.288	12.842	13.391	13.936	14.476	15.014	15.548	16.081	16.611	17.138	17.664	18.189
35	11.354	11.923	12.485	13.041	13.592	14.138	14.680	15.219	15.755	16.288	16.819	17.348	17.875
36	10.966	11.547	12.118	12.682	13.240	13.792	14.339	14.883	15.423	15.960	16.494	17.027	17.556
37	10.561	11.156	11.739	12.313	12.879	13.438	13.991	14.540	15.085	15.627	16.165	16.701	17.234
38	10.135	10.749	11.346	11.932	12.507	13.074	13.635	14.191	14.741	15.287	15.830	16.369	16.906
39	9.682	10.320	10.936	11.536	12.123	12.701	13.270	13.832	14.389	14.941	15.489	16.033	16.573
40	9.190	9.863	10.504	11.123	11.725	12.314	12.894	13.465	14.029	14.587	15.141	15.690	16.235
41	8.642	9.368	10.044	10.688	11.309	11.914	12.505	13.087	13.659	14.225	14.785	15.340	15.890
42	7.987	8.815	9.545	10.225	10.871	11.495	12.102	12.696	13.279	13.854	14.421	14.982	15.539
43		8.155	8.988	9.723	10.405	11.054	11.681	12.290	12.886	13.471	14.047	14.616	15.179
44			8.323	9.161	9.899	10.585	11.237	11.866	12.478	13.075	13.663	14.241	14.811
45				8.492	9.334	10.076	10.765	11.420	12.051	12.665	13.265	13.854	14.434
46					8.659	9.507	10.253	10.944	11.602	12.236	12.852	13.454	14.045
47						8.827	9.680	10.429	11.124	11.784	12.420	13.039	13.642
48							8.995	9.852	10.605	11.303	11.966	12.605	13.225
49								9.163	10.024	10.780	11.482	12.148	12.789
50									9.330	10.196	10.956	11.660	12.329
51										9.498	10.368	11.131	11.839
52											9.665	10.540	11.307
53												9.832	10.711
54													9.999
55													

Centre Distance Factors

Table 48

$z_g - z_k$	$z - z_k$												
	56	57	58	59	60	61	62	63	64	65	66	67	68
1	27.750	28.250	28.750	29.250	29.750	30.250	30.750	31.250	31.750	32.250	32.750	33.250	33.750
2	27.498	27.998	28.498	28.998	29.498	29.998	30.498	30.998	31.498	31.998	32.498	32.998	33.498
3	27.246	27.746	28.246	28.746	29.246	29.746	30.246	30.746	31.246	31.746	32.246	32.746	33.247
4	26.992	27.493	27.993	28.493	28.993	29.493	29.993	30.493	30.993	31.494	31.994	32.494	32.994
5	26.738	27.238	27.739	28.239	28.739	29.239	29.739	30.239	30.740	31.240	31.740	32.240	32.740
6	26.483	26.983	27.483	27.984	28.484	28.984	29.484	29.985	30.485	30.985	31.485	31.986	32.486
7	26.226	26.727	27.227	27.728	28.228	28.728	29.229	29.729	30.229	30.730	31.230	31.730	32.231
8	25.969	26.469	26.970	27.470	27.971	28.471	28.972	29.472	29.973	30.473	30.974	31.474	31.975
9	25.710	26.211	26.712	27.212	27.713	28.214	28.714	29.215	29.715	30.216	30.717	31.217	31.718
10	25.450	25.951	26.452	26.953	27.454	27.955	28.455	28.956	29.457	29.958	30.458	30.959	31.460
11	25.189	25.690	26.191	26.693	27.194	27.695	28.196	28.697	29.197	29.698	30.199	30.700	31.201
12	24.927	25.428	25.930	26.431	26.932	27.433	27.935	28.436	28.937	29.438	29.939	30.440	30.941
13	24.663	25.165	25.667	26.168	26.670	27.171	27.673	28.174	28.675	29.177	29.678	30.179	30.680
14	24.398	24.900	25.402	25.904	26.406	26.908	27.409	27.911	28.413	28.914	29.416	29.917	30.418
15	24.132	24.634	25.137	25.639	26.141	26.643	27.145	27.647	28.149	28.650	29.152	29.654	30.155
16	23.864	24.367	24.869	25.372	25.875	26.377	26.879	27.381	27.884	28.386	28.888	29.390	29.891
17	23.595	24.098	24.601	25.104	25.607	26.110	26.612	27.115	27.617	28.120	28.622	29.124	29.626
18	23.324	23.828	24.331	24.835	25.338	25.841	26.344	26.847	27.350	27.853	28.355	28.858	29.360
19	23.051	23.556	24.060	24.564	25.067	25.571	26.074	26.578	27.081	27.584	28.087	28.590	29.093
20	22.777	23.282	23.787	24.291	24.795	25.299	25.803	26.307	26.811	27.314	27.818	28.321	28.824
21	22.501	23.007	23.512	24.017	24.522	25.026	25.531	26.035	26.539	27.043	27.547	28.051	28.554
22	22.224	22.730	23.236	23.741	24.247	24.752	25.257	25.762	26.266	26.771	27.275	27.779	28.283
23	21.944	22.451	22.958	23.464	23.970	24.476	24.981	25.487	25.992	26.497	27.001	27.506	28.010
24	21.662	22.170	22.678	23.185	23.691	24.198	24.704	25.210	25.716	26.221	26.727	27.232	27.737
25	21.379	21.887	22.396	22.903	23.411	23.918	24.425	24.932	25.438	25.944	26.450	26.956	27.461
26	21.093	21.602	22.112	22.620	23.129	23.637	24.145	24.652	25.159	25.666	26.172	26.678	27.184
27	20.805	21.315	21.826	22.335	22.845	23.353	23.862	24.370	24.878	25.385	25.893	26.399	26.906
28	20.514	21.026	21.537	22.048	22.558	23.068	23.578	24.087	24.595	25.103	25.611	26.119	26.626
29	20.221	20.734	21.247	21.759	22.270	22.781	23.291	23.801	24.311	24.820	25.328	25.837	26.345
30	19.925	20.440	20.954	21.467	21.979	22.491	23.003	23.514	24.024	24.534	25.043	25.553	26.061
31	19.627	20.143	20.658	21.172	21.686	22.199	22.712	23.224	23.735	24.246	24.757	25.267	25.776
32	19.325	19.843	20.360	20.876	21.391	21.905	22.419	22.932	23.445	23.957	24.468	24.979	25.489
33	19.020	19.540	20.058	20.576	21.093	21.608	22.124	22.638	23.152	23.665	24.177	24.689	25.201
34	18.712	19.234	19.754	20.273	20.792	21.309	21.826	22.341	22.856	23.371	23.884	24.397	24.910
35	18.400	18.924	19.447	19.968	20.488	21.007	21.525	22.042	22.559	23.074	23.589	24.103	24.617
36	18.085	18.611	19.136	19.659	20.181	20.702	21.222	21.741	22.258	22.775	23.292	23.807	24.322
37	17.765	18.294	18.821	19.347	19.871	20.394	20.915	21.436	21.955	22.474	22.992	23.508	24.025
38	17.440	17.972	18.502	19.031	19.557	20.082	20.606	21.128	21.650	22.170	22.689	23.207	23.725
39	17.111	17.647	18.180	18.711	19.240	19.767	20.293	20.818	21.341	21.863	22.384	22.904	23.423
40	16.777	17.316	17.852	18.386	18.918	19.448	19.977	20.503	21.029	21.553	22.076	22.597	23.118
41	16.437	16.980	17.520	18.058	18.593	19.126	19.657	20.186	20.713	21.239	21.764	22.288	22.810
42	16.090	16.638	17.183	17.724	18.262	18.798	19.332	19.864	20.394	20.923	21.450	21.975	22.499
43	15.737	16.290	16.839	17.385	17.927	18.467	19.004	19.539	20.072	20.603	21.132	21.660	22.186
44	15.376	15.935	16.489	17.040	17.586	18.130	18.671	19.209	19.745	20.278	20.810	21.340	21.869
45	15.006	15.572	16.132	16.688	17.240	17.788	18.332	18.874	19.413	19.950	20.485	21.017	21.548
46	14.626	15.200	15.768	16.329	16.887	17.439	17.988	18.534	19.077	19.617	20.155	20.691	21.224
47	14.235	14.818	15.394	15.963	16.526	17.085	17.639	18.189	18.736	19.280	19.821	20.360	20.896
48	13.831	14.425	15.010	15.587	16.158	16.723	17.282	17.838	18.389	18.937	19.482	20.024	20.564
49	13.411	14.019	14.615	15.202	15.781	16.352	16.919	17.480	18.036	18.589	19.138	19.684	20.227
50	12.972	13.597	14.207	14.805	15.393	15.973	16.547	17.114	17.676	18.234	18.788	19.338	19.885
51	12.510	13.155	13.782	14.394	14.994	15.584	16.166	16.741	17.309	17.873	18.432	18.987	19.538
52	12.017	12.691	13.339	13.967	14.581	15.183	15.774	16.358	16.934	17.504	18.069	18.629	19.186
53	11.482	12.195	12.871	13.521	14.152	14.768	15.371	15.965	16.550	17.127	17.699	18.265	18.827
54	10.883	11.656	12.372	13.051	13.704	14.337	14.954	15.560	16.155	16.741	17.320	17.893	18.461
55	10.166	11.054	11.831	12.550	13.231	13.886	14.521	15.141	15.748	16.344	16.932	17.513	18.087
56		10.333	11.225	12.006	12.727	13.411	14.068	14.705	15.327	15.935	16.534	17.123	17.705
57			10.500	11.396	12.180	12.904	13.591	14.250	14.889	15.513	16.123	16.723	17.314
58				10.667	11.567	12.354	13.081	13.770	14.432	15.073	15.698	16.310	16.912
59					10.833	11.738	12.528	13.258	13.950	14.613	15.256	15.883	16.497
60						11.000	11.908	12.702	13.435	14.129	14.795	15.440	16.068
61								11.166	12.079	12.876	13.611	14.307	14.976
62									11.333	12.249	13.049	13.788	14.486
63										11.499	12.419	13.223	13.964
64											11.665	12.590	13.396
65												11.832	12.760
66													11.998
67													12.164
68													
69													
70													

Centre Distance Factors

Table 48

$z_g - z_k$	$z - z_k$												
	69	70	71	72	73	74	75	76	77	78	79	80	81
1	34.250	34.750	35.250	35.750	36.250	36.750	37.250	37.750	38.250	38.750	39.250	39.750	40.250
2	33.999	34.499	34.999	35.499	35.999	36.499	36.999	37.499	37.999	38.499	38.999	39.499	39.999
3	33.747	34.247	34.747	35.247	35.747	36.247	36.747	37.247	37.747	38.241	38.747	39.247	39.747
4	33.494	33.994	34.494	34.994	35.494	35.994	36.494	36.994	37.495	37.995	38.495	38.995	39.495
5	33.240	33.741	34.241	34.741	35.241	35.741	36.241	36.741	37.241	37.742	38.242	38.742	39.242
6	32.986	33.486	33.987	34.487	34.987	35.487	35.987	36.487	36.988	37.488	37.988	38.488	38.988
7	32.731	33.231	33.732	34.232	34.732	35.232	35.733	36.233	36.733	37.233	37.734	38.234	38.734
8	32.475	32.975	33.476	33.976	34.476	34.977	35.477	35.977	36.478	36.978	37.478	37.979	38.479
9	32.218	32.719	33.219	33.720	34.220	34.720	35.221	35.721	36.222	36.722	37.222	37.723	38.223
10	31.960	32.461	32.962	33.462	33.963	34.463	34.964	35.464	35.965	36.465	36.966	37.466	37.967
11	31.702	32.202	32.703	33.204	33.704	34.205	34.706	35.206	35.707	36.208	36.708	37.209	37.709
12	31.442	31.943	32.444	32.945	33.445	33.946	34.447	34.948	35.448	35.949	36.450	36.951	37.451
13	31.181	31.682	32.183	32.684	33.185	33.686	34.187	34.688	35.189	35.690	36.191	36.692	37.192
14	30.920	31.421	31.922	32.423	32.925	33.426	33.927	34.428	34.929	35.430	35.931	36.432	36.933
15	30.657	31.158	31.660	32.161	32.663	33.164	33.665	34.167	34.668	35.169	35.670	36.171	36.672
16	30.393	30.895	31.397	31.898	32.400	32.901	33.403	33.904	34.406	34.907	35.408	35.910	36.411
17	30.128	30.630	31.132	31.634	32.136	32.638	33.139	33.641	34.143	34.644	35.146	35.647	36.149
18	29.862	30.365	30.867	31.369	31.871	32.373	32.875	33.377	33.879	34.381	34.882	35.384	35.886
19	29.595	30.098	30.600	31.103	31.605	32.107	32.610	33.112	33.614	34.116	34.618	35.120	35.622
20	29.327	29.830	30.333	30.836	31.338	31.841	32.343	32.846	33.348	33.850	34.352	34.855	35.357
21	29.058	29.561	30.064	30.567	31.070	31.573	32.076	32.578	33.081	33.584	34.086	34.588	35.091
22	28.787	29.290	29.794	30.297	30.801	31.304	31.807	32.310	32.813	33.316	33.819	34.321	34.824
23	28.515	29.019	29.523	30.027	30.530	31.034	31.537	32.041	32.544	33.047	33.550	34.053	34.556
24	28.241	28.746	29.250	29.754	30.259	30.763	31.266	31.770	32.274	32.777	33.281	33.784	34.287
25	27.966	28.471	28.976	29.481	29.986	30.490	30.994	31.498	32.002	32.506	33.010	33.514	34.017
26	27.690	28.196	28.701	29.206	29.711	30.216	30.721	31.225	31.730	32.234	32.738	33.242	33.746
27	27.412	27.919	28.425	28.930	29.436	29.941	30.446	30.951	31.456	31.961	32.465	32.970	33.474
28	27.133	27.640	28.146	28.653	28.159	29.665	30.170	30.676	31.181	31.686	32.191	32.696	33.200
29	26.852	27.360	27.867	28.374	28.880	29.387	29.893	30.399	30.905	31.410	31.916	32.421	32.926
30	26.570	27.078	27.586	28.093	28.600	29.107	29.614	30.121	30.627	31.133	31.639	32.145	32.650
31	26.286	26.794	27.303	27.811	28.319	28.827	29.334	29.841	30.348	30.855	31.361	31.867	32.373
32	26.000	26.509	27.019	27.527	28.036	28.544	29.052	29.560	30.068	30.575	31.082	31.589	32.095
33	25.712	26.222	26.732	27.242	27.751	28.261	28.769	29.278	29.786	30.294	30.801	31.308	31.815
34	25.422	25.933	26.444	26.955	27.465	27.975	28.484	28.994	29.502	30.011	30.519	31.027	31.535
35	25.130	25.643	26.155	26.666	27.177	27.688	28.198	28.708	29.217	29.727	30.235	30.744	31.252
36	24.836	25.350	25.863	26.375	26.887	27.399	27.910	28.420	28.931	29.441	29.950	30.459	30.968
37	24.540	25.055	25.569	26.082	26.595	27.108	27.620	28.131	28.642	29.153	29.664	30.174	30.683
38	24.242	24.758	25.273	25.787	26.302	26.815	27.328	27.840	28.352	28.864	29.375	29.886	30.396
39	23.941	24.458	24.975	25.490	26.006	26.520	27.034	27.548	28.061	28.573	29.085	29.597	30.108
40	23.637	24.156	24.674	25.191	25.708	26.223	26.738	27.253	27.767	28.280	28.793	29.306	29.818
41	23.331	23.852	24.371	24.890	25.407	25.924	26.441	26.956	27.471	27.986	28.500	29.013	29.526
42	23.023	23.545	24.066	24.586	25.105	25.623	26.141	26.657	27.174	27.689	28.204	28.718	29.232
43	22.711	23.235	23.757	24.279	24.800	25.319	25.838	26.356	26.874	27.390	27.907	28.422	28.937
44	22.396	22.922	23.446	23.970	24.492	25.013	25.534	26.053	26.572	27.090	27.607	28.124	28.639
45	22.078	22.606	23.132	23.657	24.181	24.704	25.226	25.747	26.267	26.787	27.305	27.823	28.340
46	21.756	22.286	22.815	23.342	23.868	24.393	24.916	25.439	25.961	26.481	27.001	27.520	28.039
47	21.431	21.963	22.494	23.024	23.552	24.078	24.604	25.128	25.651	26.174	26.695	27.215	27.735
48	21.101	21.637	22.170	22.702	23.232	23.761	24.288	24.814	25.339	25.863	26.386	26.908	27.429
49	20.768	21.306	21.842	22.377	22.909	23.440	23.970	24.498	25.025	25.550	26.075	26.598	27.121
50	20.430	20.971	21.510	22.048	22.583	23.116	23.648	24.178	24.707	25.235	25.761	26.286	26.810
51	20.086	20.632	21.174	21.714	22.252	22.789	23.323	23.855	24.386	24.916	25.444	25.971	26.497
52	19.738	20.287	20.833	21.377	21.918	22.457	22.994	23.529	24.062	24.594	25.124	25.653	26.181
53	19.384	19.937	20.488	21.035	21.579	22.121	22.661	23.199	23.735	24.269	24.801	25.332	25.862
54	19.023	19.582	20.136	20.688	21.236	21.781	22.324	22.865	23.403	23.940	24.475	25.008	25.540
55	18.656	19.220	19.779	20.335	20.887	21.437	21.983	22.527	23.068	23.608	24.145	24.681	25.215
56	18.281	18.851	19.416	19.977	20.533	21.087	21.637	22.184	22.729	23.271	23.812	24.350	24.886
57	17.897	18.474	19.045	19.612	20.174	20.731	21.286	21.837	22.385	22.931	23.474	24.015	24.554
58	17.504	18.089	18.667	19.240	19.807	20.370	20.929	21.485	22.037	22.586	23.132	23.677	24.218
59	17.100	17.694	18.280	18.860	19.434	20.002	20.567	21.127	21.683	22.236	22.786	23.334	23.879
60	16.684	17.289	17.884	18.472	19.052	19.627	20.197	20.763	21.324	21.881	22.435	22.986	23.535
61	16.253	16.870	17.477	18.073	18.663	19.245	19.821	20.392	20.958	21.520	22.079	22.634	23.186
62	15.805	16.438	17.057	17.664	18.263	18.853	19.437	20.014	20.586	21.154	21.717	22.276	22.832
63	15.337	15.988	16.622	17.243	17.852	18.452	19.044	19.628	20.207	20.780	21.349	21.913	22.474
64	14.843	15.517	16.170	16.806	17.428	18.039	18.641	19.234	19.820	20.400	20.974	21.544	22.109
65	14.315	15.021	15.698	16.352	16.990	17.614	18.226	18.829	19.424	20.011	20.592	21.168	21.738
66	13.742	14.491	15.199	15.878	16.534	17.174	17.799	18.413	19.017	19.613	20.202	20.784	21.361
67	13.100	13.915	14.667	15.377	16.057	16.716	17.357	17.984	18.600	19.205	19.803	20.393	20.976
68	12.330	13.269	14.088	14.842	15.554	16.237	16.898	17.541	18.169	18.786	19.393	19.992	20.583
69		12.496	13.439	14.260	15.017	15.732	16.417	17.079	17.724	18.354	18.972	19.581	20.181
70			12.662	13.609	14.433	15.192	15.909	16.596	17.260	17.907	18.539	19.158	19.768

Centre Distance Factors

Table 48

$z_g - z_k$	$z - z_k$	82	83	84	85	86	87	88	89	90	91	92	93	94
1	40.750	41.250	41.750	42.250	42.750	43.250	43.750	44.250	44.750	45.250	45.750	46.250	46.750	
2	40.499	40.999	41.499	41.999	42.499	42.999	43.499	43.999	44.499	44.999	45.499	45.999	46.499	
3	40.247	40.747	41.247	41.747	42.247	42.747	43.247	43.747	44.247	44.747	45.247	45.747	46.247	
4	39.995	40.495	40.995	41.495	41.995	42.495	42.995	43.495	43.995	44.495	44.995	45.495	45.995	
5	39.742	40.242	40.742	41.242	41.742	42.242	42.742	43.242	43.742	44.242	44.742	45.242	45.742	
6	39.488	39.989	40.489	40.989	41.489	41.989	42.489	42.989	43.489	43.990	44.490	44.990	45.490	
7	39.234	39.734	40.235	40.735	41.235	41.735	42.235	42.735	43.236	43.736	44.236	44.736	45.236	
8	38.979	39.479	39.980	40.480	40.980	41.480	41.961	42.481	42.981	43.481	43.982	44.482	44.982	
9	38.723	39.224	39.724	40.224	40.725	41.225	41.725	42.226	42.726	43.226	43.726	44.227	44.727	
10	38.467	38.967	39.468	39.968	40.469	40.969	41.469	41.970	42.470	42.970	43.471	43.971	44.471	
11	38.210	38.710	39.211	39.711	40.212	40.712	41.213	41.713	42.214	42.714	43.214	43.715	44.215	
12	37.952	38.453	38.953	39.454	39.954	40.455	40.955	41.456	41.957	42.457	42.957	43.458	43.958	
13	37.693	38.194	38.695	39.195	39.696	40.197	40.697	41.198	41.699	42.199	42.700	43.200	43.701	
14	37.434	37.935	38.435	38.936	39.437	39.938	40.439	40.939	41.440	41.941	42.441	42.942	43.443	
15	37.173	37.674	38.175	38.676	39.177	39.678	40.179	40.680	41.181	41.682	42.182	42.683	43.184	
16	36.912	37.413	37.914	38.416	38.917	39.418	39.919	40.420	40.921	41.422	41.923	42.424	42.924	
17	36.650	37.151	37.653	38.154	38.655	39.156	39.658	40.159	40.660	41.161	41.662	42.163	42.664	
18	36.387	36.889	37.390	37.892	38.393	38.894	39.396	39.897	40.398	40.900	41.401	41.902	42.403	
19	36.122	36.625	37.127	37.628	38.130	38.632	39.133	39.635	40.136	40.637	41.139	41.640	42.141	
20	35.859	36.361	36.862	37.364	37.866	38.368	38.870	39.371	39.873	40.374	40.876	41.377	41.879	
21	35.593	36.095	36.597	37.099	37.601	38.103	38.605	39.107	39.609	40.111	40.612	41.124	41.616	
22	35.326	35.829	36.331	36.833	37.336	37.838	38.340	38.842	39.344	39.846	40.348	40.850	41.352	
23	35.059	35.561	36.064	36.567	37.069	37.572	38.074	38.576	39.078	39.581	40.083	40.585	41.087	
24	34.790	35.293	35.796	36.299	36.802	37.304	37.807	38.309	38.812	39.314	39.817	40.319	40.821	
25	34.520	35.024	35.527	36.030	36.533	37.036	37.539	38.042	38.544	39.047	39.550	40.052	40.555	
26	34.250	34.753	35.257	35.760	36.264	36.767	37.270	37.773	38.276	38.779	39.282	39.785	40.287	
27	33.978	34.482	34.986	35.489	35.993	36.497	37.000	37.504	38.007	38.510	39.013	39.516	40.019	
28	33.705	34.209	34.714	35.218	35.722	36.226	36.729	37.233	37.737	38.240	38.743	39.247	39.750	
29	33.431	33.936	34.440	34.945	35.449	35.953	36.457	36.961	37.465	37.969	38.473	38.976	39.480	
30	33.156	33.661	34.166	34.671	35.175	35.680	36.185	36.689	37.193	37.697	38.201	38.705	39.209	
31	32.879	33.385	33.890	34.396	34.901	35.406	35.911	36.415	36.920	37.424	37.929	38.433	38.937	
32	32.601	33.107	33.613	34.119	34.625	35.130	35.635	36.141	36.645	37.150	37.655	38.160	38.664	
33	32.322	32.829	33.335	33.842	34.348	34.854	35.359	35.865	36.370	36.875	37.380	37.885	38.390	
34	32.042	32.549	33.056	33.563	34.069	34.576	35.082	35.588	36.094	36.599	37.105	37.610	38.115	
35	31.760	32.268	32.775	33.283	33.790	34.297	34.803	35.310	35.816	36.322	36.828	37.334	37.839	
36	31.477	31.985	32.494	33.001	33.509	34.016	34.523	35.030	35.537	36.044	36.550	37.056	37.562	
37	31.192	31.701	32.210	32.719	33.227	33.735	34.242	34.750	35.257	35.764	36.271	36.778	37.284	
38	30.906	31.416	31.925	32.434	32.943	33.452	33.960	34.468	34.976	35.483	35.991	36.498	37.005	
39	30.619	31.129	31.639	32.149	32.658	33.167	33.676	34.185	34.693	35.201	35.709	36.217	36.724	
40	30.329	30.841	31.351	31.862	32.372	32.882	33.391	33.900	34.409	34.918	35.426	35.935	36.442	
41	30.038	30.550	31.062	31.573	32.084	32.595	33.105	33.615	34.124	34.633	35.142	35.651	36.160	
42	29.746	30.259	30.771	31.283	31.795	32.306	32.817	33.327	33.838	34.347	34.857	35.366	35.875	
43	29.451	29.965	30.478	30.991	31.504	32.016	32.527	33.039	33.550	34.060	34.570	35.080	35.590	
44	29.155	29.670	30.184	30.698	31.211	31.724	32.236	32.748	33.260	33.771	34.282	34.793	35.303	
45	28.857	29.372	29.888	30.402	30.917	31.430	31.944	32.457	32.969	33.481	33.993	34.504	35.015	
46	28.556	29.073	29.590	30.105	30.621	31.135	31.649	32.163	32.676	33.189	33.702	34.214	34.725	
47	28.254	28.772	29.289	29.806	30.323	30.838	31.353	31.868	32.382	32.896	33.409	33.922	34.434	
48	27.949	28.469	28.987	29.505	30.023	30.539	31.056	31.571	32.086	32.601	33.115	33.628	34.142	
49	27.642	28.163	28.683	29.202	29.721	30.239	30.756	31.272	31.788	32.304	32.819	33.333	33.848	
50	27.333	27.855	28.377	28.897	29.417	29.936	30.454	30.972	31.489	32.005	32.521	33.037	33.552	
51	27.021	27.545	28.068	28.590	29.111	29.631	30.151	30.669	31.188	31.705	32.222	32.739	33.254	
52	26.707	27.232	27.757	28.280	28.803	29.324	29.845	30.365	30.884	31.403	31.921	32.438	32.955	
53	26.390	26.917	27.443	27.968	28.492	29.015	29.537	30.058	30.579	31.099	31.618	32.136	32.654	
54	26.070	26.599	27.127	27.653	28.179	28.703	29.227	29.750	30.272	30.793	31.313	31.833	32.352	
55	25.747	26.278	26.808	27.336	27.863	28.389	28.915	29.439	29.962	30.484	31.006	31.527	32.047	
56	25.421	25.954	26.486	27.016	27.545	28.073	28.600	29.125	29.650	30.174	30.697	31.219	31.740	
57	25.091	25.627	26.161	26.693	27.224	27.754	28.282	28.809	29.336	29.861	30.385	30.909	31.431	
58	24.758	25.296	25.832	26.367	26.900	27.432	27.962	28.491	29.019	29.546	30.072	30.597	31.121	
59	24.421	24.962	25.501	26.038	26.573	27.107	27.639	28.170	28.700	29.228	29.756	30.282	30.808	
60	24.080	24.624	25.165	25.705	26.243	26.779	27.313	27.846	28.378	28.908	29.437	29.965	30.492	
61	23.735	24.282	24.826	25.369	25.909	26.447	26.984	27.519	28.053	28.585	29.116	29.646	30.174	
62	23.385	23.936	24.483	25.028	25.571	26.112	26.651	27.189	27.725	28.259	28.792	29.323	29.854	
63	23.031	23.585	24.136	24.684	25.230	25.774	26.316	26.855	27.394	27.930	28.465	28.999	29.531	
64	22.671	23.229	23.783	24.335	24.885	25.431	25.976	26.519	27.059	27.598	28.135	28.671	29.205	
65	22.305	22.867	23.426	23.982	24.535	25.085	25.633	26.178	26.721	27.263	27.802	28.340	28.876	
66	21.933	22.500	23.064	23.624	24.180	24.734	25.285	25.833	26.380	26.924	27.466	28.006	28.544	
67	21.554	22.127	22.695	23.260	23.821	24.378	24.933	25.485	26.034	26.581	27.126	27.669	28.209	
68	21.168	21.747	22.321	22.890	23.456	24.018	24.576	25.132	25.684	26.234	26.782	27.328	27.871	
69	20.773	21.359	21.939	22.514	23.085	23.651	24.214	24.774	25.330	25.883	26.434	26.983	27.529	
70	20.369	20.963	21.550	22.132	22.708	23.279	23.847	24.410	24.971	25.528	26.082	26.634	27.183	

Centre Distance Factors

Table 48

$z_g - z_k$	$z - z_k$												
	95	96	97	98	99	100	101	102	103	104	105	106	107
1	47.250	47.750	48.250	48.750	49.250	49.750	50.250	50.750	51.250	51.750	52.250	52.750	53.250
2	46.999	47.499	47.999	48.499	48.999	49.499	49.999	50.499	50.999	51.499	51.999	52.499	52.999
3	46.748	47.248	47.748	48.248	48.748	49.248	49.748	50.248	50.748	51.248	51.748	52.248	52.748
4	46.496	46.996	47.496	47.996	48.496	48.996	49.496	49.996	50.496	50.996	51.496	51.996	52.496
5	46.243	46.743	47.243	47.743	48.243	48.743	49.244	49.744	50.244	50.744	51.244	51.744	52.244
6	45.990	46.490	46.990	47.490	47.990	48.491	48.991	49.491	49.991	50.491	50.991	51.491	51.991
7	45.736	46.237	46.737	47.237	47.737	48.237	48.737	49.237	49.737	50.238	50.738	51.238	51.738
8	45.482	45.982	46.483	46.983	47.483	47.983	48.483	48.983	49.484	49.984	50.484	50.984	51.484
9	45.227	45.728	46.228	46.728	47.228	47.728	48.229	48.729	49.229	49.729	50.230	50.730	51.230
10	44.972	45.472	45.972	46.473	46.973	47.473	47.974	48.474	48.974	49.474	49.975	50.475	50.975
11	44.716	45.216	45.716	46.217	46.717	47.217	47.718	48.218	48.719	49.219	49.719	50.219	50.720
12	44.459	44.959	45.460	45.960	46.461	46.961	47.462	47.962	48.462	48.963	49.463	49.963	50.464
13	44.202	44.702	45.203	45.703	46.204	46.704	47.205	47.705	48.206	48.706	49.206	49.707	50.207
14	43.943	44.444	44.945	45.445	45.946	46.446	46.947	47.448	47.948	48.449	48.949	49.450	49.950
15	43.685	44.185	44.686	45.187	45.688	46.188	46.689	47.190	47.690	48.191	48.691	49.192	49.693
16	43.425	43.926	44.427	44.928	45.429	45.929	46.430	46.931	47.432	47.932	48.433	48.934	49.434
17	43.165	43.666	44.167	44.668	45.169	45.670	46.171	46.671	47.172	47.673	48.174	48.675	49.176
18	42.904	43.405	43.906	44.408	44.909	45.410	45.911	46.412	46.912	47.413	47.914	48.415	48.916
19	42.643	43.144	43.645	44.146	44.647	45.149	45.650	46.151	46.652	47.153	47.654	48.155	48.656
20	42.380	42.882	43.383	43.884	44.386	44.887	45.388	45.889	46.391	46.892	47.393	47.894	48.395
21	42.117	42.619	43.120	43.622	44.123	44.625	45.126	45.628	46.129	46.630	47.131	47.633	48.134
22	41.853	42.355	42.857	43.359	43.860	44.362	44.863	45.365	45.866	46.368	46.869	47.371	47.872
23	41.589	42.091	42.593	43.094	43.596	44.098	44.600	45.101	45.603	46.105	46.606	47.108	47.609
24	41.323	41.825	42.328	42.830	43.331	43.833	44.335	44.837	45.339	45.841	46.342	46.844	47.346
25	41.057	41.559	42.062	42.564	43.066	43.568	44.070	44.572	45.074	45.576	46.078	46.580	47.082
26	40.790	41.292	41.795	42.297	42.800	43.302	43.804	44.307	44.809	45.311	45.813	46.315	46.817
27	40.522	41.025	41.527	42.030	42.533	43.035	43.538	44.040	44.543	45.045	45.547	46.049	46.551
28	40.253	40.756	41.259	41.762	42.265	42.768	43.270	43.773	44.276	44.778	45.281	45.783	46.285
29	39.983	40.487	40.990	41.493	41.996	42.499	43.002	43.505	44.008	44.510	45.013	45.516	46.018
30	39.713	40.216	40.720	41.223	41.727	42.230	42.733	43.236	43.739	44.242	44.745	45.248	45.751
31	39.441	39.945	40.449	40.952	41.456	41.960	42.463	42.966	43.470	43.973	44.476	44.979	45.482
32	39.168	39.673	40.177	40.681	41.185	41.688	42.192	42.696	43.199	43.703	44.206	44.710	45.213
33	38.895	39.399	39.904	40.408	40.912	41.417	41.921	42.424	42.928	43.432	43.936	44.439	44.943
34	38.620	39.125	39.630	40.135	40.639	41.144	41.648	42.152	42.656	43.160	43.664	44.168	44.672
35	38.345	38.850	39.355	39.860	40.365	40.870	41.374	41.879	42.383	42.888	43.392	43.896	44.400
36	38.068	38.574	39.079	39.585	40.090	40.595	41.100	41.605	42.110	42.614	43.119	43.623	44.127
37	37.790	38.296	38.802	39.308	39.814	40.319	40.825	41.330	41.835	42.340	42.845	43.349	43.854
38	37.511	38.018	38.524	39.030	39.536	40.042	40.548	41.054	41.559	42.064	42.570	43.075	43.580
39	37.231	37.738	38.245	38.752	39.258	39.765	40.271	40.777	41.282	41.788	42.294	42.799	43.304
40	36.950	37.458	37.965	38.472	38.979	39.486	39.992	40.499	41.005	41.511	42.017	42.523	43.028
41	36.668	37.176	37.684	38.191	38.699	39.206	39.713	40.219	40.726	41.233	41.739	42.245	42.751
42	36.384	36.893	37.401	37.909	38.417	38.925	39.432	39.939	40.446	40.953	41.460	41.966	42.473
43	36.099	36.608	37.117	37.626	38.134	38.642	39.150	39.658	40.166	40.673	41.180	41.687	42.194
44	35.813	36.323	36.832	37.341	37.850	38.359	38.867	39.376	39.884	40.391	40.899	41.406	41.914
45	35.526	36.036	36.546	37.056	37.565	38.074	38.583	39.092	39.601	40.109	40.617	41.125	41.632
46	35.237	35.748	36.258	36.769	37.279	37.789	38.298	38.807	39.316	39.825	40.334	40.842	41.350
47	34.946	35.458	35.969	36.480	36.991	37.501	38.012	38.521	39.031	39.540	40.049	40.558	41.067
48	34.654	35.167	35.679	36.191	36.702	37.213	37.724	38.234	38.744	39.254	39.764	40.273	40.782
49	34.361	34.874	35.387	35.900	36.412	36.923	37.435	37.946	38.456	38.967	39.477	39.987	40.497
50	34.066	34.580	35.094	35.607	36.120	36.632	37.144	37.656	38.167	38.678	39.189	39.700	40.210
51	33.770	34.285	34.799	35.313	35.826	36.340	36.852	37.365	37.877	38.389	38.900	39.411	39.922
52	33.472	33.987	34.503	35.017	35.532	36.046	36.559	37.072	37.585	38.097	38.610	39.121	39.633
53	33.172	33.688	34.204	34.720	35.235	35.750	36.264	36.778	37.292	37.805	38.318	38.830	39.342
54	32.870	33.388	33.905	34.421	34.937	35.453	35.968	36.483	36.997	37.511	38.025	38.538	39.050
55	32.566	33.085	33.603	34.121	34.638	35.154	35.670	36.186	36.701	37.216	37.730	38.244	38.757
56	32.261	32.781	33.300	33.819	34.337	34.854	35.371	35.887	36.403	36.919	37.434	37.948	38.463
57	31.953	32.474	32.995	33.515	34.034	34.552	35.070	35.587	36.104	36.620	37.136	37.652	38.167
58	31.644	32.166	32.688	33.209	33.729	34.248	34.767	35.285	35.803	36.320	36.837	37.353	37.869
59	31.332	31.856	32.379	32.901	33.422	33.943	34.463	34.982	35.501	36.019	36.537	37.054	37.570
60	31.018	31.543	32.067	32.591	33.113	33.635	34.156	34.677	35.196	35.716	36.234	36.752	37.270
61	30.702	31.228	31.754	32.279	32.803	33.326	33.848	34.369	34.890	35.411	35.930	36.449	36.968
62	30.383	30.911	31.438	31.964	32.490	33.014	33.538	34.060	34.582	35.104	35.624	36.144	36.664
63	30.062	30.592	31.120	31.648	32.175	32.700	33.225	33.749	34.273	34.795	35.317	35.838	36.358
64	29.738	30.269	30.800	31.329	31.857	32.384	32.911	33.436	33.961	34.484	35.007	35.530	36.051
65	29.411	29.945	30.477	31.008	31.528	32.066	32.594	33.121	33.647	34.172	34.696	35.219	35.742
66	29.081	29.617	30.151	30.684	31.215	31.746	32.275	32.803	33.331	33.857	34.383	34.907	35.431
67	28.749	29.286	29.822	30.357	30.891	31.423	31.954	32.483	33.012	33.540	34.067	34.593	35.118
68	28.413	28.953	29.491	30.028	30.563	31.097	31.630	32.161	32.692	33.221	33.749	34.277	34.803
69	28.073	28.616	29.156	29.695	30.233	30.769	31.303	31.836	32.369	32.900	33.429	33.958	34.486
70	27.730	28.275	28.818	29.360	29.899	30.437	30.974	31.509	32.043	32.576	33.107	33.638	34.167

Centre Distance Factors

Table 48

$z_g - z_k$	$z - z_k$												
	108	109	110	111	112	113	114	115	116	117	118	119	120
1	53.750	54.250	54.750	55.250	55.750	56.250	57.750	57.250	57.750	58.250	58.750	59.250	59.750
2	53.499	53.999	54.499	54.999	55.499	55.999	56.499	56.999	57.499	57.999	58.499	58.999	59.499
3	53.248	53.748	54.248	54.748	55.248	55.748	56.248	56.748	57.248	57.748	58.248	58.748	59.248
4	52.996	53.496	53.996	54.496	54.996	55.496	55.996	56.496	56.996	57.496	57.996	58.497	58.997
5	52.744	53.244	53.744	54.244	54.744	55.244	55.744	56.244	56.744	57.244	57.744	58.245	58.745
6	52.491	52.991	53.491	53.992	54.492	54.992	55.492	55.992	56.492	56.992	57.492	57.992	58.492
7	52.238	52.738	53.238	53.738	54.239	54.739	55.239	55.739	56.239	56.739	57.239	57.739	58.239
8	51.984	52.485	52.985	53.485	53.985	54.485	54.985	55.485	55.985	56.486	56.986	57.486	57.986
9	51.730	52.230	52.731	53.231	53.731	54.231	54.731	55.231	55.732	56.232	56.732	57.232	57.732
10	51.475	51.976	52.476	52.976	53.476	53.977	54.477	54.977	55.477	55.977	56.478	56.978	57.478
11	51.220	51.720	52.221	52.721	53.221	53.721	54.222	54.722	55.222	55.722	56.223	56.723	57.223
12	50.964	51.465	51.965	52.465	52.966	53.466	53.966	54.466	54.967	55.467	55.967	56.468	56.968
13	50.708	51.208	51.709	52.209	52.709	53.210	53.710	54.210	54.711	55.211	55.712	56.212	56.712
14	50.451	50.951	51.452	51.952	52.453	52.953	53.454	53.954	54.454	54.955	55.455	55.956	56.456
15	50.193	50.694	51.194	51.695	52.195	52.696	53.196	53.697	54.197	54.698	55.198	55.699	56.199
16	49.935	50.436	50.936	51.437	51.938	52.438	52.939	53.439	53.940	54.440	54.941	55.441	55.942
17	49.676	50.177	50.678	51.178	51.679	52.180	52.680	53.181	53.682	54.182	54.683	55.184	55.684
18	49.417	49.918	50.419	50.919	51.420	51.921	52.422	52.922	53.423	53.924	54.425	54.925	55.426
19	49.157	49.658	50.159	50.660	51.161	51.661	52.162	52.663	53.164	53.665	54.166	54.666	55.167
20	48.896	49.397	49.898	50.399	50.900	51.401	51.902	52.403	52.904	53.405	53.906	54.407	54.908
21	48.635	49.136	49.637	50.139	50.640	51.141	51.642	52.143	52.644	53.145	53.646	54.147	54.648
22	48.373	48.874	49.376	49.877	50.378	50.879	51.381	51.882	52.383	52.884	53.385	53.886	54.387
23	48.111	48.612	49.113	49.615	50.116	50.618	51.119	51.620	52.121	52.623	53.124	53.625	54.126
24	47.847	48.349	48.851	49.352	49.854	50.355	50.856	51.358	51.859	52.361	52.862	53.363	53.864
25	47.583	48.085	48.587	49.089	49.590	50.092	50.593	51.095	51.596	52.098	52.599	53.101	53.602
26	47.319	47.821	48.323	48.825	49.326	49.828	50.330	50.831	51.333	51.835	52.336	52.838	53.339
27	47.054	47.556	48.058	48.560	49.062	49.564	50.065	50.567	51.069	51.571	52.073	52.574	53.076
28	46.788	47.290	47.792	48.294	48.796	49.298	49.800	50.302	50.804	51.306	51.808	52.310	52.812
29	46.521	47.023	47.526	48.028	48.530	49.033	49.535	50.037	50.539	51.041	51.543	52.045	52.547
30	46.253	46.756	47.259	47.761	48.264	48.766	49.268	49.771	50.273	50.775	51.278	51.780	52.282
31	45.985	46.488	46.991	47.493	47.996	48.499	49.001	49.504	50.006	50.509	51.011	51.514	52.016
32	45.716	46.219	46.722	47.225	47.728	48.231	48.734	49.236	49.739	50.242	50.744	51.247	51.749
33	45.446	45.950	46.453	46.956	47.459	47.962	48.465	48.968	49.471	49.974	50.476	50.979	51.482
34	45.175	45.679	46.183	46.686	47.189	47.693	48.196	48.699	49.202	49.705	50.208	50.711	51.214
35	44.904	45.408	45.912	46.415	46.919	47.422	47.926	48.429	48.933	49.436	49.939	50.442	50.945
36	44.632	45.136	45.640	46.144	46.648	47.151	47.655	48.159	48.662	49.166	49.669	50.172	50.676
37	44.359	44.863	45.367	45.871	46.376	46.880	47.384	47.887	48.391	48.895	49.399	49.902	50.406
38	44.084	44.589	45.094	45.598	46.103	46.607	47.111	47.615	48.119	48.623	49.127	49.631	50.135
39	43.810	44.315	44.819	45.324	45.829	46.334	46.838	47.342	47.847	48.351	48.855	49.359	49.863
40	43.534	44.039	44.544	45.049	45.554	46.059	46.564	47.069	47.573	48.078	48.582	49.087	49.591
41	43.257	43.763	44.268	44.774	45.279	45.784	46.289	46.794	47.299	47.804	48.309	48.813	49.318
42	42.979	43.485	43.991	44.497	45.003	45.508	46.014	46.519	47.024	47.529	48.034	48.539	49.044
43	42.700	43.207	43.713	44.219	44.725	45.231	45.737	46.243	46.748	47.254	47.759	48.264	48.769
44	42.421	42.928	43.434	43.941	44.447	44.953	45.460	45.965	46.471	46.977	47.483	47.988	48.493
45	42.140	42.647	43.154	43.661	44.168	44.675	45.181	45.687	46.194	46.700	47.206	47.711	48.217
46	41.858	42.366	42.873	43.381	43.888	44.395	44.902	45.409	45.915	46.421	46.928	47.434	47.940
47	41.575	42.083	42.591	43.099	43.607	44.114	44.622	45.129	45.636	46.142	46.649	47.155	47.662
48	41.291	41.800	42.308	42.817	43.325	43.833	44.340	44.848	45.355	45.862	46.369	46.876	47.383
49	41.006	41.515	42.024	42.533	43.042	43.550	44.058	44.566	45.074	45.581	46.089	46.596	47.103
50	40.720	41.230	41.739	42.248	42.757	43.266	43.775	44.283	44.791	45.299	45.807	46.315	46.822
51	40.432	40.943	41.453	41.962	42.472	42.981	43.490	43.999	44.508	45.016	45.524	46.032	46.540
52	40.144	40.655	41.165	41.676	42.186	42.695	43.205	43.714	44.223	44.732	45.241	45.749	46.258
53	39.854	40.365	40.877	41.387	41.898	42.408	42.918	43.428	43.938	44.447	44.956	45.465	45.974
54	39.563	40.075	40.587	41.098	41.609	42.120	42.631	43.141	43.651	44.161	44.671	45.180	45.689
55	39.270	39.783	40.295	40.807	41.319	41.831	42.342	42.853	43.363	43.874	44.384	44.894	45.404
56	38.976	39.490	40.003	40.516	41.028	41.540	42.052	42.563	43.075	43.585	44.096	44.607	45.117
57	38.681	39.195	39.709	40.223	40.736	41.248	41.761	42.273	42.785	43.296	43.807	44.318	44.829
58	38.385	38.899	39.414	39.928	40.442	40.955	41.468	41.981	42.493	43.005	43.517	44.029	44.540
59	38.086	38.602	39.117	39.632	40.147	40.661	41.175	41.688	42.201	42.714	43.226	43.738	44.250
60	37.787	38.303	38.819	39.335	39.850	40.365	40.879	41.394	41.907	42.421	42.934	43.446	43.959
61	37.486	38.003	38.520	39.036	39.552	40.068	40.583	41.098	41.612	42.126	42.640	43.153	43.666
62	37.183	37.701	38.219	38.736	39.253	39.769	40.285	40.801	41.316	41.831	42.345	42.859	43.373
63	36.878	37.398	37.916	38.435	38.952	39.469	39.986	40.502	41.018	41.534	42.049	42.563	43.078
64	36.572	37.092	37.612	38.131	38.650	39.168	39.685	40.203	40.719	41.235	41.751	42.267	42.782
65	36.264	36.785	37.306	37.826	38.346	38.865	39.383	39.901	40.419	40.936	41.452	41.968	42.484
66	35.954	36.477	36.999	37.520	38.040	38.560	39.080	39.598	40.117	40.635	41.152	41.669	42.185
67	35.643	36.166	36.689	37.211	37.733	38.254	38.774	39.294	39.813	40.332	40.850	41.368	41.885
68	35.329	35.854	36.378	36.901	37.424	37.946	38.467	38.988	39.508	40.028	40.547	41.065	41.584
69	35.013	35.539	36.065	36.589	37.113	37.636	38.159	38.680	39.201	39.722	40.242	40.762	41.280
70	34.695	35.223	35.750	36.275	36.800	37.325	37.848	38.371	38.893	39.415	39.936	40.456	40.976

Centre Distance Factors

Table 48

$z_g - z_k$	$z - z_k$												
	121	122	123	124	125	126	127	128	129	130	131	132	133
1	60.250	60.750	61.250	61.750	62.250	62.750	63.250	63.750	64.250	64.750	65.250	65.750	65.250
2	59.999	60.499	60.999	61.499	61.999	62.499	62.999	63.499	63.999	64.499	64.999	65.499	65.999
3	59.748	60.248	60.748	61.248	61.748	62.248	62.748	63.248	63.748	64.248	64.748	65.248	65.748
4	55.497	59.997	60.497	60.997	61.497	61.997	62.497	62.997	63.497	63.997	64.497	64.997	65.497
5	59.245	59.745	60.245	60.745	61.245	61.745	62.245	62.745	63.245	63.745	64.245	64.745	65.245
6	58.992	59.492	59.992	60.492	60.992	61.493	61.993	62.493	62.993	63.493	63.993	64.493	64.993
7	58.739	59.240	59.740	60.240	60.740	61.240	61.740	62.240	62.740	63.240	63.740	64.240	64.740
8	58.486	58.986	59.486	59.986	60.487	60.987	61.487	61.987	62.487	62.987	63.487	63.987	64.487
9	58.232	58.732	59.233	59.733	60.233	60.733	61.233	61.733	62.233	62.734	63.234	63.734	64.234
10	57.978	58.478	58.979	59.479	59.979	60.479	60.979	61.479	61.980	62.480	62.980	63.480	63.980
11	57.723	58.224	58.724	59.224	59.724	60.225	60.725	61.225	61.725	62.225	62.726	63.226	63.726
12	57.468	57.969	58.469	58.969	59.469	59.970	60.470	60.970	61.470	61.971	62.471	62.971	63.471
13	57.213	57.713	58.213	58.713	59.214	59.714	60.214	60.715	61.215	61.715	62.216	62.716	63.216
14	56.956	57.457	57.957	58.458	58.958	59.458	59.959	60.459	60.959	61.460	61.960	62.460	62.961
15	56.700	57.200	57.701	58.201	58.701	59.202	59.702	60.203	60.703	61.203	61.704	62.204	62.704
16	56.443	56.943	57.444	57.944	58.444	58.945	59.445	59.946	60.446	60.947	61.447	61.948	62.448
17	56.185	56.685	57.186	57.687	58.187	58.688	59.188	59.689	60.189	60.690	61.190	61.691	62.191
18	55.927	56.427	56.928	57.429	57.929	58.430	58.930	59.431	59.931	60.432	60.933	61.433	61.934
19	55.668	56.169	56.669	57.170	57.671	58.171	58.672	59.173	59.673	60.174	60.675	61.175	61.676
20	55.409	55.909	56.410	56.911	57.412	57.912	58.413	58.914	59.415	59.915	60.416	60.917	61.417
21	55.149	55.650	56.150	56.651	57.152	57.653	58.154	58.655	59.156	59.656	60.157	60.658	61.159
22	54.888	55.389	55.890	56.391	56.892	57.393	57.894	58.395	58.896	59.397	59.898	60.399	60.899
23	54.627	55.128	55.630	56.131	56.632	57.133	57.634	58.135	58.636	59.137	59.638	60.139	60.639
24	54.366	54.867	55.368	55.869	56.370	56.872	57.373	57.874	58.375	58.876	59.377	59.878	60.379
25	54.104	54.605	55.106	55.608	56.109	56.610	57.111	57.613	58.114	58.615	59.116	59.617	60.118
26	53.841	54.342	54.844	55.345	55.847	56.348	56.849	57.351	57.852	58.353	58.854	59.356	59.857
27	53.578	54.079	54.581	55.082	55.584	56.085	56.587	57.088	57.590	58.091	58.592	59.094	59.595
28	53.314	53.815	54.317	54.819	55.320	55.822	56.324	56.825	57.327	57.828	58.330	58.831	59.333
29	53.049	53.551	54.053	54.555	55.056	55.558	56.060	56.562	57.063	57.565	58.066	58.568	59.070
30	52.784	53.286	53.788	54.290	54.792	55.294	55.796	56.297	56.799	57.301	57.803	58.304	58.806
31	52.518	53.020	53.522	54.025	54.527	55.029	55.531	56.033	56.535	57.036	57.538	58.040	58.542
32	52.252	52.754	53.256	53.759	54.261	54.763	55.265	55.767	56.269	56.771	57.273	57.775	58.277
33	51.984	52.487	52.989	53.492	53.994	54.497	54.999	55.501	56.003	56.505	57.007	57.509	58.012
34	51.717	52.219	52.722	53.225	53.727	54.230	54.732	55.235	55.737	56.239	56.742	57.244	57.746
35	51.448	51.951	52.454	52.957	53.460	53.962	54.465	54.967	55.470	55.973	56.475	56.977	57.480
36	51.179	51.682	52.185	52.688	53.191	53.694	54.197	54.700	55.202	55.705	56.208	56.710	57.213
37	50.909	51.412	51.916	52.419	52.922	53.425	53.928	54.431	54.934	55.437	55.940	56.443	56.945
38	50.638	51.142	51.645	52.149	52.652	53.156	53.659	54.162	54.665	55.168	55.671	56.174	56.677
39	50.367	50.871	51.375	51.878	52.382	52.885	53.389	53.892	54.395	54.899	55.402	55.905	56.408
40	50.095	50.599	51.103	51.607	52.111	52.614	53.118	53.622	54.125	54.629	55.132	55.635	56.139
41	49.822	50.326	50.831	51.335	51.839	52.343	52.847	53.350	53.854	54.358	54.861	55.365	55.868
42	49.548	50.053	50.557	51.062	51.566	52.070	52.574	53.079	53.582	54.086	54.590	55.094	55.598
43	49.274	49.779	50.284	50.788	51.293	51.797	52.302	52.806	53.310	53.814	54.318	54.822	55.326
44	48.999	49.504	50.009	50.514	51.019	51.523	52.028	52.533	53.037	53.541	54.046	54.550	55.054
45	48.723	49.228	49.733	50.239	50.744	51.249	51.754	52.258	52.763	53.268	53.772	54.277	54.781
46	48.446	48.952	49.457	49.963	50.468	50.973	51.479	51.984	52.489	52.993	53.498	54.003	54.508
47	48.168	48.674	49.180	49.686	50.192	50.697	51.203	51.708	52.213	52.718	53.223	53.728	54.233
48	47.889	48.396	48.902	49.408	49.914	50.420	50.926	51.432	51.937	52.443	52.948	53.453	53.958
49	47.610	48.117	48.623	49.130	49.636	50.142	50.648	51.154	51.660	52.166	52.672	53.177	53.683
50	47.329	47.837	48.344	48.850	49.357	49.864	50.370	50.876	51.383	51.889	52.394	52.900	53.406
51	47.048	47.556	48.063	48.570	49.077	49.584	50.091	50.598	51.104	51.610	52.117	52.623	53.129
52	46.766	47.274	47.781	48.289	48.796	49.304	49.811	50.318	50.825	51.331	51.838	52.344	52.851
53	46.482	46.991	47.499	48.007	48.515	49.022	49.530	50.037	50.544	51.051	51.558	52.065	52.572
54	46.198	46.707	47.216	47.724	48.232	48.740	49.248	49.756	50.263	50.771	51.278	51.785	52.292
55	45.913	46.422	46.931	47.440	47.949	48.457	48.965	49.474	49.981	50.489	50.997	51.504	52.012
56	45.627	46.136	46.646	47.155	47.664	48.173	48.682	49.190	49.699	50.207	50.715	51.223	51.730
57	45.339	45.850	46.359	46.869	47.379	47.888	48.397	48.906	49.415	49.923	50.432	50.940	51.448
58	45.051	45.562	46.072	46.582	47.092	47.602	48.112	48.621	49.130	49.639	50.148	50.657	51.165
59	44.761	45.273	45.784	46.294	46.805	47.315	47.825	48.335	48.845	49.354	49.863	50.372	50.881
60	44.471	44.982	45.494	46.005	46.516	47.027	47.538	48.048	48.558	49.068	49.577	50.087	50.596
61	44.179	44.691	45.203	45.715	46.227	46.738	47.249	47.760	48.270	48.781	49.291	49.801	50.310
62	43.886	44.399	44.912	45.424	45.936	46.448	46.959	47.471	47.982	48.493	49.003	49.513	50.024
63	43.592	44.105	44.619	45.132	45.644	46.157	46.669	47.180	47.692	48.203	48.714	49.225	49.736
64	43.296	43.810	44.324	44.838	45.351	45.864	46.377	46.889	47.401	47.913	48.425	48.936	49.447
65	42.999	43.514	44.029	44.543	45.057	45.571	46.084	46.597	47.109	47.622	48.134	48.646	49.157
66	42.701	43.217	43.732	44.247	44.762	45.276	45.790	46.303	46.817	47.329	47.842	48.354	48.867
67	42.402	42.918	43.434	43.950	44.465	44.980	45.494	46.009	46.522	47.036	47.549	48.062	48.575
68	42.101	42.618	43.135	43.651	44.167	44.683	45.198	45.713	46.227	46.741	47.255	47.769	48.282
69	41.799	42.317	42.834	43.351	43.868	44.384	44.900	45.416	45.931	46.446	46.960	47.474	47.988
70	41.495	42.014	42.532	43.050	43.568	44.085	44.601	45.117	45.633	46.149	46.664	47.178	47.693

Centre Distance Factors

Table 48

$z_g - z_k$	$z - z_k$												
	134	135	136	137	138	139	140	141	142	143	144	145	146
1	66.750	67.250	67.750	68.250	68.750	69.250	69.750	70.250	70.750	71.250	71.750	72.250	72.750
2	66.499	66.999	67.499	67.999	68.499	68.999	69.499	69.999	70.499	70.999	71.499	71.999	72.499
3	66.248	66.748	67.248	67.748	68.248	68.748	69.248	69.748	70.248	70.748	71.248	71.748	72.248
4	65.997	66.497	66.997	67.497	67.997	68.497	68.997	69.497	69.997	70.497	70.997	71.497	71.997
5	65.745	66.245	66.745	67.245	67.745	68.245	68.745	69.245	69.745	70.245	70.745	71.245	71.745
6	65.493	65.993	66.493	66.993	67.493	67.993	68.493	68.993	69.493	69.993	70.493	70.994	71.494
7	65.240	65.741	66.241	66.741	67.241	67.741	68.241	68.741	69.241	69.741	70.241	70.741	71.241
8	64.988	65.488	65.988	66.488	66.988	67.488	67.988	68.488	68.988	69.488	69.988	70.488	70.989
9	64.734	65.234	65.734	66.234	66.735	67.235	67.735	68.235	68.735	69.235	69.735	70.235	70.735
10	64.480	64.980	65.481	65.981	66.481	66.981	67.481	67.981	68.481	68.982	69.482	69.982	70.482
11	64.226	64.726	65.226	65.727	66.227	66.727	67.227	67.727	68.228	68.728	69.228	69.728	70.228
12	63.971	64.472	64.972	65.472	65.972	66.473	66.973	67.473	67.973	68.473	68.974	69.474	69.974
13	63.716	64.217	64.717	65.217	65.717	66.218	66.718	67.218	67.718	68.219	68.719	69.219	69.719
14	63.461	63.961	64.461	64.962	65.462	65.962	66.463	66.963	67.463	67.963	68.464	68.964	69.464
15	63.205	63.705	64.206	64.706	65.206	65.707	66.207	66.707	67.208	67.708	68.208	68.708	69.209
16	62.948	63.449	63.949	64.450	64.950	65.450	65.951	66.451	66.952	67.452	67.952	68.453	68.953
17	62.692	63.192	63.692	64.193	64.693	65.194	65.694	66.195	66.695	67.196	67.696	68.196	68.697
18	62.434	62.935	63.435	63.936	64.436	64.937	65.437	65.938	66.438	66.939	67.439	67.940	68.440
19	62.176	62.677	63.178	63.678	64.179	64.679	65.180	65.680	66.181	66.681	67.182	67.682	68.183
20	61.918	62.419	62.919	63.420	63.921	64.421	64.922	65.422	65.923	66.424	66.924	67.425	67.925
21	61.659	62.160	62.661	63.162	63.662	64.163	64.664	65.164	65.665	66.166	66.666	67.167	67.667
22	61.400	61.901	62.402	62.902	63.403	63.904	64.405	64.905	65.406	65.907	66.408	66.908	67.409
23	61.140	61.641	62.142	62.643	63.144	63.645	64.145	64.646	65.147	65.648	66.149	66.649	67.150
24	60.880	61.381	61.882	62.383	62.884	63.385	63.886	64.387	64.887	65.388	65.889	66.390	66.891
25	60.619	61.120	61.621	62.122	62.624	63.125	63.626	64.126	64.627	65.128	65.629	66.130	66.631
26	60.358	60.859	61.360	61.862	62.363	62.864	63.365	63.866	64.367	64.868	65.369	65.870	66.371
27	60.096	60.598	61.099	61.600	62.101	62.602	63.104	63.605	64.106	64.607	65.108	65.609	66.110
28	59.834	60.335	60.837	61.338	61.839	62.341	62.842	63.343	63.844	64.346	64.847	65.348	65.849
29	55.571	60.073	60.574	61.075	61.577	62.078	62.580	63.081	63.582	64.084	64.585	65.086	65.587
30	59.308	59.809	60.311	60.812	61.314	61.815	62.317	62.818	63.320	63.821	64.323	64.824	65.325
31	59.044	59.545	60.047	60.549	61.051	61.552	62.054	62.555	63.057	63.558	64.060	64.561	65.063
32	58.779	59.281	59.783	60.285	60.786	61.288	61.790	62.292	62.793	63.295	63.797	64.298	64.800
33	58.514	59.016	59.518	60.020	60.522	61.024	61.526	62.027	62.529	63.031	63.533	64.034	64.536
34	58.248	58.751	59.253	59.755	60.257	60.759	61.261	61.763	62.265	62.767	63.268	63.770	64.272
35	57.982	58.485	58.987	59.489	59.991	60.493	60.995	61.497	62.000	62.502	63.004	63.505	64.007
36	57.715	58.218	58.720	59.223	59.725	60.227	60.729	61.232	61.734	62.236	62.738	63.240	63.742
37	57.448	57.951	58.453	58.956	59.458	59.961	60.463	60.965	61.468	61.970	62.472	62.974	63.477
38	57.180	57.683	58.185	58.688	59.191	59.693	60.196	60.698	61.201	61.703	62.206	62.708	63.210
39	56.911	57.414	57.917	58.420	58.923	59.426	59.928	60.431	60.934	61.436	61.939	62.441	62.944
40	56.642	57.145	57.648	58.151	58.654	59.157	59.660	60.163	60.666	61.168	61.671	62.174	62.676
41	56.372	56.875	57.379	57.882	58.385	58.888	59.391	59.894	60.397	60.900	61.403	61.906	62.409
42	56.101	56.605	57.108	57.612	58.115	58.618	59.122	59.625	60.128	60.631	61.134	61.637	62.140
43	55.830	56.334	56.837	57.341	57.845	58.348	58.852	59.355	59.858	60.362	60.865	61.368	61.871
44	55.558	56.062	56.566	57.070	57.574	58.077	58.581	59.085	59.588	60.091	60.595	61.098	61.602
45	55.285	55.790	56.294	56.798	57.302	57.806	58.310	58.813	59.317	59.821	60.324	60.828	61.331
46	55.012	55.517	56.021	56.525	57.029	57.534	58.038	58.542	59.046	59.549	60.053	60.557	61.061
47	54.738	55.243	55.747	56.252	56.756	57.261	57.765	58.269	58.773	59.277	59.781	60.285	60.789
48	54.463	54.968	55.473	55.978	56.483	56.987	57.492	57.996	58.500	59.005	59.509	60.013	60.517
49	54.188	54.693	55.198	55.703	56.208	56.713	57.218	57.722	58.227	58.731	59.236	59.740	60.245
50	53.912	54.417	54.922	55.428	55.933	56.438	56.943	57.448	57.953	58.457	58.962	59.467	59.971
51	53.635	54.140	54.646	55.152	55.657	56.162	56.668	57.173	57.678	58.183	58.688	59.193	59.697
52	53.357	53.863	54.369	54.875	55.380	55.886	56.392	56.897	57.402	57.908	58.413	58.918	59.423
53	53.078	53.585	54.091	54.597	55.103	55.609	56.115	56.620	57.126	57.632	58.137	58.642	59.147
54	52.799	53.306	53.812	54.319	54.825	55.331	55.837	56.343	56.849	57.355	57.861	58.366	58.872
55	52.519	53.026	53.533	54.039	54.546	55.053	55.559	56.065	56.571	57.077	57.583	58.089	58.595
56	52.238	52.745	53.252	53.759	54.266	54.773	55.280	55.786	56.293	56.799	57.305	57.812	58.318
57	51.956	52.464	52.971	53.479	53.986	54.493	55.000	55.507	56.014	56.520	57.027	57.533	58.040
58	51.673	52.181	52.689	53.197	53.705	54.212	54.719	55.227	55.734	56.241	56.748	57.254	57.761
59	51.390	51.898	52.406	52.915	53.423	53.930	54.438	54.946	55.453	55.960	56.467	56.974	57.481
60	51.105	51.614	52.123	52.631	53.140	53.648	54.156	54.664	55.171	55.679	56.187	56.694	57.201
61	50.820	51.329	51.838	52.347	52.856	53.364	53.873	54.381	54.889	55.397	55.905	56.412	56.920
62	50.533	51.043	51.553	52.062	52.571	53.080	53.589	54.098	54.606	55.114	55.622	56.130	56.638
63	50.246	50.756	51.266	51.776	52.286	52.795	53.304	53.813	54.322	54.831	55.339	55.847	56.356
64	49.958	50.469	50.979	51.489	51.999	52.509	53.018	53.528	54.037	54.546	55.055	55.564	56.072
65	49.669	50.180	50.691	51.201	51.712	52.222	52.732	53.242	53.751	54.261	54.770	55.279	55.788
66	49.378	49.890	50.401	50.912	51.423	51.934	52.444	52.955	53.465	53.975	54.484	54.994	55.503
67	49.087	49.599	50.111	50.623	51.134	51.645	52.156	52.667	53.177	53.687	54.198	54.707	55.217
68	48.795	49.307	49.820	50.332	50.844	51.355	51.867	52.378	52.889	53.399	53.910	54.420	54.930
69	48.501	49.015	49.527	50.040	50.552	51.065	51.576	52.088	52.599	53.111	53.621	54.132	54.643
70	48.207	48.721	49.234	49.747	50.260	50.773	51.285	51.797	52.309	52.821	53.332	53.843	54.354

Centre Distance Factors

Table 48

$z_g - z_k$	$z - z_k$												
	147	148	149	150	151	152	153	154	155	156	157	158	159
1	73.250	73.750	74.250	74.750	75.250	75.750	76.250	76.750	77.250	77.750	78.250	78.750	79.250
2	72.999	73.499	73.999	74.499	74.999	75.499	75.999	76.499	76.999	77.499	77.999	78.499	78.999
3	72.748	73.248	73.748	74.248	74.748	75.248	75.748	76.248	76.748	77.248	77.749	78.249	78.749
4	72.497	72.997	73.497	73.997	74.497	74.997	75.497	75.997	76.497	76.997	77.497	77.997	78.497
5	72.246	72.746	73.246	73.746	74.246	74.746	75.246	75.746	76.246	76.746	77.246	77.746	78.246
6	71.994	72.494	72.994	73.494	73.994	74.494	74.994	75.494	75.994	76.494	76.994	77.494	77.994
7	71.741	72.241	72.741	73.241	73.742	74.242	74.742	75.242	75.742	76.242	76.742	77.242	77.742
8	71.489	71.989	72.489	72.989	73.489	73.989	74.489	74.989	75.489	75.989	76.489	76.989	77.490
9	71.236	71.736	72.236	72.736	73.236	73.736	74.236	74.736	75.236	75.736	76.237	76.737	77.237
10	70.982	71.482	71.982	72.482	72.983	73.483	73.983	74.483	74.983	75.483	75.983	76.483	76.984
11	70.728	71.228	71.729	72.229	72.729	73.229	73.729	74.229	74.729	75.230	75.730	76.230	76.730
12	70.474	70.974	71.474	71.975	72.475	72.975	73.475	73.975	74.475	74.976	75.476	75.976	76.476
13	70.219	70.720	71.220	71.720	72.220	72.721	73.221	73.721	74.221	74.721	75.221	75.722	76.222
14	69.964	70.465	70.965	71.465	71.965	72.466	72.966	73.466	73.966	74.467	74.967	75.467	75.967
15	69.709	70.209	70.710	71.210	71.710	72.210	72.711	73.211	73.711	74.212	74.712	75.212	75.712
16	69.453	69.954	70.454	70.954	71.455	71.955	72.455	72.956	73.456	73.956	74.456	74.957	75.457
17	69.197	69.697	70.198	70.698	71.199	71.699	72.199	72.700	73.200	73.700	74.201	74.701	75.201
18	68.940	69.441	69.941	70.442	70.942	71.443	71.943	72.443	72.944	73.444	73.944	74.445	74.945
19	68.683	69.184	69.684	70.185	70.685	71.186	71.686	72.187	72.687	73.187	73.688	74.188	74.689
20	68.426	68.926	69.427	69.928	70.428	70.929	71.429	71.930	72.430	72.930	73.431	73.931	74.432
21	68.168	68.669	69.169	69.670	70.170	70.671	71.171	71.672	72.173	72.673	73.174	73.674	74.175
22	67.910	68.410	68.911	69.412	69.912	70.413	70.913	71.414	71.915	72.415	72.916	73.416	73.917
23	67.651	68.152	68.652	69.153	69.654	70.154	70.655	71.156	71.656	72.157	72.658	73.158	73.659
24	67.392	67.892	68.393	68.894	69.395	69.896	70.396	70.897	71.398	71.898	72.399	72.900	73.401
25	67.132	67.633	68.134	68.635	69.135	69.636	70.137	70.638	71.139	71.639	72.140	72.641	73.142
26	66.872	67.373	67.874	68.375	68.876	69.376	69.877	70.378	70.879	71.380	71.881	72.382	72.882
27	66.611	67.112	67.613	68.114	68.615	69.116	69.617	70.118	70.619	71.120	71.621	72.122	72.623
28	66.350	66.851	67.352	67.854	68.355	68.856	69.357	69.858	70.359	70.860	71.361	71.862	72.363
29	66.089	66.590	67.091	67.592	68.093	68.595	69.096	69.597	70.098	70.599	71.100	71.601	72.102
30	65.827	66.328	66.829	67.331	67.832	68.333	68.834	69.335	69.837	70.338	70.839	71.340	71.841
31	65.564	66.066	66.567	67.068	67.570	68.071	68.572	69.074	69.575	70.076	70.577	71.079	71.580
32	65.301	65.803	66.304	66.806	67.307	67.809	68.310	68.811	69.313	69.814	70.315	70.817	71.318
33	65.038	65.539	66.041	66.543	67.044	67.546	68.047	68.549	69.050	69.552	70.053	70.554	71.056
34	64.774	65.276	65.777	66.279	66.781	67.282	67.784	68.285	68.787	69.289	69.790	70.292	70.793
35	64.509	65.011	65.513	66.015	66.517	67.018	67.520	68.022	68.523	69.025	69.527	70.028	70.530
36	64.244	64.746	65.248	65.750	66.252	66.754	67.256	67.758	68.259	68.761	69.263	69.765	70.266
37	63.979	64.481	64.983	65.485	65.987	66.489	66.991	67.493	67.995	68.497	68.999	69.500	70.002
38	63.713	64.215	64.717	65.219	65.721	66.224	66.726	67.228	67.730	68.232	68.734	69.236	69.738
39	63.446	63.949	64.451	64.953	65.455	65.958	66.460	66.962	67.464	67.966	68.468	68.970	69.472
40	63.179	63.682	64.184	64.686	65.189	65.691	66.194	66.696	67.198	67.700	68.203	68.705	69.207
41	62.911	63.414	63.917	64.419	64.922	65.424	65.927	66.429	66.932	67.434	67.936	68.439	68.941
42	62.643	63.146	63.649	64.151	64.654	65.157	65.659	66.162	66.665	67.167	67.670	68.172	68.674
43	62.374	62.877	63.380	63.883	64.386	64.889	65.392	65.894	66.397	66.900	67.402	67.905	68.407
44	62.105	62.608	63.111	63.614	64.117	64.620	65.123	65.626	66.129	66.632	67.134	67.637	68.140
45	61.835	62.338	62.841	63.345	63.848	64.351	64.854	65.357	65.860	66.363	66.866	67.369	67.872
46	61.564	62.068	62.575	63.071	63.578	64.081	64.585	65.088	65.591	66.094	66.597	67.100	67.603
47	61.293	61.797	62.300	62.804	63.308	63.811	64.314	64.818	65.321	65.824	66.328	66.831	67.334
48	61.021	61.525	62.029	62.533	63.036	63.540	64.044	64.547	65.051	65.554	66.058	66.561	67.064
49	60.749	61.253	61.757	62.261	62.765	63.269	63.773	64.276	64.780	65.284	65.787	66.291	66.794
50	60.476	60.980	61.484	61.988	62.493	62.997	63.501	64.005	64.509	65.012	65.516	66.020	66.523
51	60.202	60.707	61.211	61.715	62.220	62.724	63.228	63.732	64.236	64.740	65.244	65.748	66.252
52	59.928	60.432	60.937	61.442	61.946	62.451	62.955	63.460	63.964	64.468	64.972	65.476	65.980
53	59.653	60.158	60.663	61.167	61.672	62.177	62.682	63.186	63.691	64.195	64.699	65.204	65.708
54	59.377	59.882	60.387	60.892	61.397	61.902	62.407	62.912	63.417	63.921	64.426	64.930	65.435
55	59.100	59.606	60.111	60.617	61.122	61.627	62.132	62.637	63.142	63.647	64.152	64.657	65.161
56	58.823	59.329	59.835	60.341	60.846	61.351	61.857	62.362	62.867	63.372	63.877	64.382	64.887
57	58.546	59.052	59.558	60.064	60.569	61.075	61.581	62.086	62.591	63.097	63.602	64.107	64.612
58	58.267	58.774	59.280	59.786	60.292	60.798	61.304	61.809	62.315	62.821	63.326	63.831	64.337
59	51.988	58.495	59.001	59.508	60.014	60.520	61.026	61.532	62.038	62.544	63.049	63.555	64.061
60	57.708	58.215	58.722	59.228	59.735	60.242	60.748	61.254	61.760	62.266	62.772	63.278	63.784
61	57.427	57.935	58.442	58.949	59.456	59.962	60.469	60.975	61.482	61.988	62.494	63.000	63.506
62	57.146	57.653	58.161	58.668	59.175	59.682	60.189	60.696	61.203	61.709	62.216	62.722	63.228
63	56.864	57.372	57.879	58.387	58.894	59.402	59.909	60.416	60.923	61.430	61.937	62.443	62.950
64	56.581	57.089	57.597	58.105	58.613	59.120	59.628	60.135	60.642	61.150	61.657	62.164	62.670
65	56.297	56.805	57.314	57.822	58.330	58.838	59.346	59.854	60.361	60.869	61.376	61.883	62.390
66	56.012	56.521	57.030	57.538	58.047	58.555	59.063	59.571	60.079	60.587	61.095	61.602	62.110
67	55.727	56.236	56.745	57.254	57.763	58.272	58.780	59.288	59.797	60.305	60.813	61.320	61.828
68	55.440	55.950	56.459	56.969	57.478	57.987	58.496	59.005	59.513	60.022	60.530	61.038	61.546
69	55.153	55.663	56.173	56.683	57.192	57.702	58.211	58.720	59.229	59.738	60.246	60.755	61.263
70	54.865	55.375	55.886	56.396	56.906	57.416	57.925	58.435	58.944	59.453	59.962	60.471	60.979

Centre Distance Factors

Table 48

$z_g - z_k$	$z - z_k$												
		160	161	162	163	164	165	166	167	168	169	170	171
1	79.750	80.250	80.750	81.250	81.750	82.250	82.750	83.250	83.750	84.250	84.750	85.250	85.750
2	79.499	79.999	80.499	80.999	81.499	81.999	82.499	82.999	83.499	83.999	84.499	84.999	85.499
3	79.249	79.749	80.249	80.749	81.249	81.749	82.249	82.749	83.249	83.749	84.249	84.749	85.249
4	78.997	79.497	79.997	80.497	80.997	81.497	81.997	82.498	82.998	83.498	83.998	84.498	84.998
5	78.746	79.246	79.746	80.246	80.746	81.246	81.746	82.246	82.746	83.246	83.746	84.246	84.746
6	78.494	78.994	79.494	79.994	80.494	80.994	81.494	81.994	82.494	82.994	83.495	83.995	84.495
7	78.242	78.742	79.242	79.742	80.242	80.742	81.242	81.742	82.242	82.742	83.243	83.743	84.243
8	77.990	78.490	78.990	79.490	79.990	80.490	80.990	81.490	81.990	82.490	82.990	83.490	83.990
9	77.737	78.237	78.737	79.237	79.737	80.237	80.737	81.237	81.737	82.237	82.738	83.238	83.738
10	77.484	77.984	78.484	78.984	79.484	79.984	80.484	80.984	81.484	81.985	82.485	82.985	83.485
11	77.230	77.730	78.230	78.730	79.231	79.731	80.231	80.731	81.231	81.731	82.231	82.731	83.232
12	76.976	77.476	77.977	78.477	78.977	79.477	79.977	80.477	80.977	81.478	81.978	82.478	82.978
13	76.722	77.222	77.722	78.223	78.723	79.223	79.723	80.223	80.723	81.224	81.724	82.224	82.724
14	76.467	76.968	77.468	77.968	78.468	78.969	79.469	79.969	80.469	80.969	81.469	81.970	82.470
15	76.213	76.713	77.213	77.713	78.214	78.714	79.214	79.714	80.214	80.715	81.215	81.715	82.215
16	75.957	76.458	76.958	77.458	77.958	78.459	78.959	79.459	79.959	80.460	80.960	81.460	81.960
17	75.702	76.202	76.702	77.203	77.703	78.203	78.703	79.204	79.704	80.204	80.705	81.205	81.705
18	75.446	75.946	76.446	76.947	77.447	77.947	78.448	78.948	79.448	79.949	80.449	80.949	81.450
19	75.189	75.690	76.190	76.690	77.191	77.691	78.191	78.692	79.192	79.693	80.193	80.693	81.194
20	74.932	75.433	75.933	76.434	76.934	77.435	77.935	78.435	78.936	79.436	79.937	80.437	80.937
21	74.675	75.176	75.676	76.177	76.677	77.178	77.678	78.178	78.679	79.179	79.680	80.180	80.681
22	74.418	74.918	75.419	75.919	76.420	76.920	77.421	77.921	78.422	78.922	79.423	79.923	80.424
23	74.160	74.660	75.161	75.661	76.162	76.663	77.163	77.664	78.164	78.665	79.165	79.666	80.166
24	73.901	74.402	74.903	75.403	75.904	76.404	76.905	77.406	77.906	78.407	78.907	79.408	79.909
25	73.642	74.143	74.644	75.145	75.645	76.146	76.647	77.147	77.648	78.149	78.649	79.150	79.651
26	73.383	73.884	74.385	74.886	75.386	75.887	76.388	76.889	77.389	77.890	78.391	78.891	79.392
27	73.124	73.625	74.125	74.626	75.127	75.628	76.129	76.629	77.130	77.631	78.132	78.633	79.133
28	72.864	73.365	73.866	74.366	74.867	75.368	75.869	76.370	76.871	77.372	77.872	78.373	78.874
29	72.603	73.104	73.605	74.106	74.607	75.108	75.609	76.110	76.611	77.112	77.613	78.114	78.614
30	72.342	72.843	73.345	73.846	74.347	74.848	75.349	75.850	76.351	76.852	77.353	77.854	78.354
31	72.081	72.582	73.083	73.584	74.086	74.587	75.088	75.589	76.090	76.591	77.092	77.593	78.094
32	71.819	72.321	72.822	73.323	73.824	74.325	74.827	75.328	75.829	76.330	76.831	77.332	77.833
33	71.557	72.059	72.560	73.061	73.562	74.064	74.565	75.066	75.567	76.069	76.570	77.071	77.572
34	71.295	71.796	72.297	72.799	73.300	73.801	74.303	74.804	75.305	75.807	76.308	76.809	77.311
35	71.031	71.533	72.034	72.536	73.037	73.539	74.040	74.542	75.043	75.544	76.046	76.547	77.049
36	70.768	71.270	71.771	72.273	72.774	73.276	73.777	74.279	74.780	75.282	75.783	76.285	76.786
37	70.504	71.006	71.507	72.009	72.511	73.012	73.514	74.016	74.517	75.019	75.520	76.022	76.523
38	70.239	70.741	71.243	71.745	72.247	72.748	73.250	73.752	74.254	74.755	75.257	75.758	76.260
39	69.975	70.476	70.978	71.480	71.982	72.484	72.986	73.488	73.989	74.491	74.993	75.495	75.996
40	69.709	70.211	70.713	71.215	71.717	72.219	72.721	73.223	73.725	74.227	74.729	75.230	75.732
41	69.443	69.945	70.448	70.950	71.452	71.954	72.456	72.958	73.460	73.962	74.464	74.966	75.468
42	69.177	69.679	70.181	70.684	71.186	71.688	72.190	72.692	73.195	73.697	74.199	74.701	75.203
43	68.910	69.412	69.915	70.417	70.920	71.422	71.924	72.426	72.929	73.431	73.933	74.435	74.937
44	68.642	69.145	69.648	70.150	70.653	71.155	71.658	72.160	72.662	73.165	73.667	74.169	74.671
45	68.375	68.877	69.380	69.883	70.385	70.888	71.390	71.893	72.395	72.898	73.400	73.903	74.405
46	68.106	68.609	69.112	69.615	70.117	70.620	71.123	71.625	72.128	72.631	73.133	73.636	74.138
47	67.837	68.340	68.843	69.346	69.849	70.352	70.855	71.358	71.860	72.363	72.866	73.368	73.871
48	67.568	68.071	68.574	69.077	69.580	70.083	70.586	71.089	71.592	72.095	72.598	73.100	73.603
49	67.298	67.801	68.304	68.808	69.311	69.814	70.317	70.820	71.323	71.826	72.329	72.832	73.335
50	67.027	67.531	68.034	68.537	69.041	69.544	70.047	70.551	71.054	71.557	72.060	72.563	73.066
51	66.756	67.260	67.763	68.267	68.770	69.274	69.777	70.281	70.784	71.287	71.791	72.294	72.797
52	66.484	66.988	67.492	67.996	68.499	69.003	69.507	70.010	70.514	71.017	71.521	72.024	72.527
53	66.212	66.716	67.220	67.724	68.228	68.732	69.235	69.739	70.243	70.746	71.250	71.754	72.257
54	65.939	66.443	66.948	67.452	67.956	68.460	68.964	69.468	69.971	70.475	70.979	71.483	71.986
55	65.666	66.170	66.675	67.179	67.683	68.187	68.691	69.196	69.700	70.204	70.707	71.211	71.715
56	65.392	65.896	66.401	66.905	67.410	67.914	68.419	68.923	69.427	69.931	70.435	70.939	71.443
57	65.117	65.622	66.127	66.631	67.136	67.641	68.145	68.650	69.154	69.658	70.163	70.667	71.171
58	64.842	65.347	65.852	66.357	66.862	67.367	67.871	68.376	68.881	69.385	69.889	70.394	70.898
59	64.566	65.071	65.577	66.082	66.587	67.092	67.597	68.102	68.606	69.111	69.616	70.120	70.625
60	64.289	64.795	65.300	65.806	66.311	66.816	67.322	67.827	68.332	68.837	69.341	69.846	70.351
61	64.012	64.518	65.024	65.529	66.035	66.540	67.046	67.551	68.056	68.561	69.067	69.571	70.076
62	63.735	64.241	64.747	65.252	65.758	66.264	66.770	67.275	67.780	68.286	68.791	69.296	69.801
63	63.456	63.962	64.469	64.975	65.481	65.987	66.493	66.998	67.504	68.009	68.515	69.020	69.526
64	63.177	63.684	64.190	64.696	65.203	65.709	66.215	66.721	67.227	67.733	68.238	68.744	69.249
65	62.897	63.404	63.911	64.417	64.924	65.430	65.937	66.443	66.949	67.455	67.961	68.467	68.973
66	62.617	63.124	63.631	64.138	64.645	65.151	65.658	66.164	66.671	67.177	67.683	68.189	68.695
67	62.336	62.843	63.350	63.858	64.365	64.872	65.378	65.885	66.392	66.898	67.405	67.911	68.417
68	62.054	62.562	63.069	63.577	64.084	64.591	65.098	65.605	66.112	66.619	67.126	67.632	68.139
69	61.771	62.279	62.787	63.295	63.803	64.310	64.817	65.325	65.832	66.339	66.846	67.353	67.859
70	61.488	61.996	62.504	63.013	63.520	64.028	64.536	65.044	65.551	66.058	66.565	67.073	67.580

Centre Distance Factors

Table 48

$z_g - z_k$	$z - z_k$												
	173	174	175	176	177	178	179	180	181	182	183	184	185
1	86.250	86.750	87.250	87.750	88.250	88.750	89.250	89.750	90.250	90.750	91.250	91.750	92.250
2	85.999	86.499	86.999	87.499	87.999	88.499	88.999	89.499	89.999	90.499	90.999	91.499	91.999
3	85.749	86.249	86.749	87.249	87.749	88.249	88.749	89.249	89.749	90.249	90.749	91.249	91.749
4	85.498	85.998	86.498	86.998	87.498	87.998	88.498	88.998	89.498	89.998	90.498	90.998	91.498
5	85.246	85.746	86.246	86.746	87.246	87.746	88.246	88.746	89.246	89.746	90.246	90.746	91.246
6	84.995	85.495	85.995	86.495	86.995	87.495	87.995	88.495	88.995	89.495	89.995	90.495	90.995
7	84.743	85.243	85.743	86.243	86.743	87.243	87.743	88.243	88.743	89.243	89.743	90.243	90.743
8	84.490	84.990	85.490	85.991	86.491	86.991	87.491	87.991	88.491	88.991	89.491	89.991	90.491
9	84.238	84.738	85.238	85.738	86.238	86.738	87.238	87.738	88.238	88.738	89.238	89.738	90.238
10	83.985	84.485	84.985	85.485	85.985	86.485	86.985	87.485	87.986	88.486	88.986	89.486	89.986
11	83.732	84.232	84.732	85.232	85.732	86.232	86.732	87.232	87.733	88.233	88.733	89.233	89.733
12	83.478	83.978	84.478	84.979	85.479	85.979	86.479	86.979	87.479	87.979	88.479	88.979	89.480
13	83.224	83.724	84.225	84.725	85.225	85.725	86.225	86.725	87.225	87.726	88.226	88.726	89.226
14	82.970	83.470	83.970	84.471	84.971	85.471	85.971	86.471	86.971	87.472	87.972	88.472	88.972
15	82.716	83.216	83.716	84.216	84.716	85.217	85.717	86.217	86.717	87.217	87.717	88.218	88.718
16	82.461	82.961	83.461	83.961	84.462	84.962	85.462	85.962	86.462	86.963	87.463	87.963	88.463
17	82.205	82.706	83.206	83.706	84.206	84.707	85.207	85.707	86.208	86.708	87.208	87.708	88.208
18	81.950	82.450	82.950	83.451	83.951	84.451	84.952	85.452	85.952	86.452	86.953	87.453	87.953
19	81.694	82.194	82.695	83.195	83.695	84.196	84.696	85.196	85.697	86.197	86.697	87.198	87.698
20	81.438	81.938	82.439	82.939	83.439	83.940	84.440	84.940	85.441	85.941	86.441	86.942	87.442
21	81.181	81.682	82.182	82.682	83.183	83.683	84.184	84.684	85.184	85.685	86.185	86.686	87.186
22	80.924	81.425	81.925	82.426	82.926	83.426	83.927	84.427	84.928	85.428	85.929	86.429	86.929
23	80.667	81.167	81.668	82.168	82.669	83.169	83.670	84.170	84.671	85.171	85.672	86.172	86.673
24	80.409	80.910	81.410	81.911	82.411	82.912	83.412	83.913	84.414	84.914	85.415	85.915	86.415
25	80.151	80.652	81.152	81.653	82.154	82.654	83.155	83.655	84.156	84.656	85.157	85.658	86.158
26	79.893	80.393	80.894	81.395	81.895	82.396	82.897	83.397	83.898	84.398	84.899	85.400	85.900
27	79.634	80.135	80.635	81.136	81.637	82.138	82.638	83.139	83.640	84.140	84.641	85.142	85.642
28	79.375	79.876	80.376	80.877	81.378	81.879	82.379	82.880	83.381	83.882	84.382	84.883	85.384
29	79.115	79.616	80.117	80.618	81.119	81.619	82.120	82.621	83.122	83.623	84.123	84.624	85.125
30	78.855	79.356	79.857	80.358	80.859	81.360	81.861	82.362	82.862	83.363	83.864	84.365	84.866
31	78.595	79.096	79.597	80.098	80.599	81.100	81.601	82.102	82.603	83.103	83.604	84.105	84.606
32	78.334	78.835	79.336	79.837	80.338	80.839	81.340	81.841	82.342	82.843	83.344	83.845	84.346
33	78.073	78.574	79.076	79.577	80.078	80.579	81.080	81.581	82.082	82.583	83.084	83.585	84.086
34	77.812	78.313	78.814	79.315	79.816	80.318	80.819	81.320	81.821	82.322	82.823	83.324	83.825
35	77.550	78.051	78.552	79.054	79.555	80.056	80.557	81.059	81.560	82.061	82.562	83.063	83.564
36	77.287	77.789	78.290	78.792	79.293	79.794	80.295	80.797	81.298	81.799	82.300	82.802	83.303
37	77.025	77.526	78.028	78.529	79.030	79.532	80.033	80.535	81.036	81.537	82.038	82.540	83.041
38	76.762	77.263	77.765	78.266	78.768	79.269	79.771	80.272	80.773	81.275	81.776	82.278	82.779
39	76.498	77.000	77.501	78.003	78.504	79.006	79.508	80.009	80.511	81.012	81.514	82.015	82.516
40	76.234	76.736	77.237	77.739	78.241	78.743	79.244	79.746	80.247	80.749	81.250	81.752	82.253
41	75.970	76.471	76.973	77.475	77.977	78.479	78.980	79.482	79.984	80.485	80.987	81.489	81.990
42	75.705	76.207	76.709	77.210	77.712	78.214	78.716	79.218	79.720	80.221	80.723	81.225	81.726
43	75.439	75.941	76.443	76.945	77.447	77.949	78.451	78.953	79.455	79.957	80.459	80.961	81.462
44	75.174	75.676	76.178	76.680	77.182	77.684	78.186	78.688	79.190	79.692	80.194	80.696	81.198
45	74.907	75.410	75.912	76.414	76.916	77.418	77.921	78.423	78.925	79.427	79.929	80.431	80.933
46	74.641	75.143	75.645	76.148	76.650	77.152	77.655	78.157	78.659	79.161	79.663	80.165	80.668
47	74.373	74.876	75.379	75.881	76.383	76.886	77.388	77.890	78.393	78.895	79.397	79.900	80.402
48	74.106	74.609	75.111	75.614	76.116	76.619	77.121	77.624	78.126	78.629	79.131	79.633	80.136
49	73.838	74.341	74.843	75.346	75.849	76.351	76.854	77.357	77.859	78.362	78.864	79.367	79.869
50	73.569	74.072	74.575	75.078	75.581	76.083	76.586	77.089	77.592	78.094	78.597	79.099	79.602
51	73.300	73.803	74.306	74.809	75.312	75.815	76.318	76.821	77.324	77.826	78.329	78.832	79.334
52	73.031	73.534	74.037	74.540	75.043	75.546	76.049	76.552	77.055	77.558	78.061	78.564	79.066
53	72.760	73.264	73.767	74.270	74.774	75.277	75.780	76.283	76.786	77.289	77.792	78.295	78.798
54	72.490	72.993	73.497	74.000	74.504	75.007	75.510	76.014	76.517	77.020	77.523	78.026	78.529
55	72.219	72.723	73.226	73.730	74.233	74.737	75.240	75.744	76.247	76.750	77.253	77.757	78.260
56	71.947	72.451	72.955	73.459	73.962	74.466	74.970	75.473	75.977	76.480	76.983	77.487	77.990
57	71.675	72.179	72.683	73.187	73.691	74.195	74.698	75.202	75.706	76.209	76.713	77.216	77.720
58	71.402	71.907	72.411	72.915	73.419	73.923	74.427	74.931	75.434	75.938	76.442	76.946	77.449
59	71.129	71.634	72.138	72.642	73.146	73.651	74.155	74.659	75.163	75.667	76.170	76.674	77.178
60	70.855	71.360	71.865	72.369	72.873	73.378	73.882	74.386	74.890	75.394	75.898	76.402	76.906
61	70.581	71.086	71.591	72.095	72.600	73.104	73.609	74.113	74.618	75.122	75.626	76.130	76.634
62	70.306	70.811	71.316	71.821	72.326	72.830	73.335	73.840	74.344	74.849	75.353	75.857	76.362
63	70.031	70.536	71.041	71.546	72.051	72.556	73.061	73.566	74.070	74.575	75.079	75.584	76.088
64	69.755	70.260	70.766	71.271	71.776	72.281	72.786	73.291	73.796	74.301	74.805	75.310	75.815
65	69.478	69.984	70.489	70.995	71.500	72.006	72.511	73.016	73.521	74.026	74.531	75.036	75.540
66	69.201	69.707	70.213	70.718	71.224	71.729	72.235	72.740	73.245	73.751	74.256	74.761	75.266
67	68.923	69.429	69.935	70.441	70.947	71.453	71.958	72.464	72.969	73.475	73.980	74.485	74.991
68	68.645	69.151	69.658	70.164	70.670	71.176	71.681	72.187	72.693	73.198	73.704	74.209	74.715
69	68.366	68.873	69.379	69.885	70.392	70.898	71.404	71.910	72.416	72.921	73.427	73.933	74.438
70	68.086	68.593	69.100	69.606	70.113	70.619	71.126	71.632	72.138	72.644	73.150	73.656	74.162

Assembly and Storage

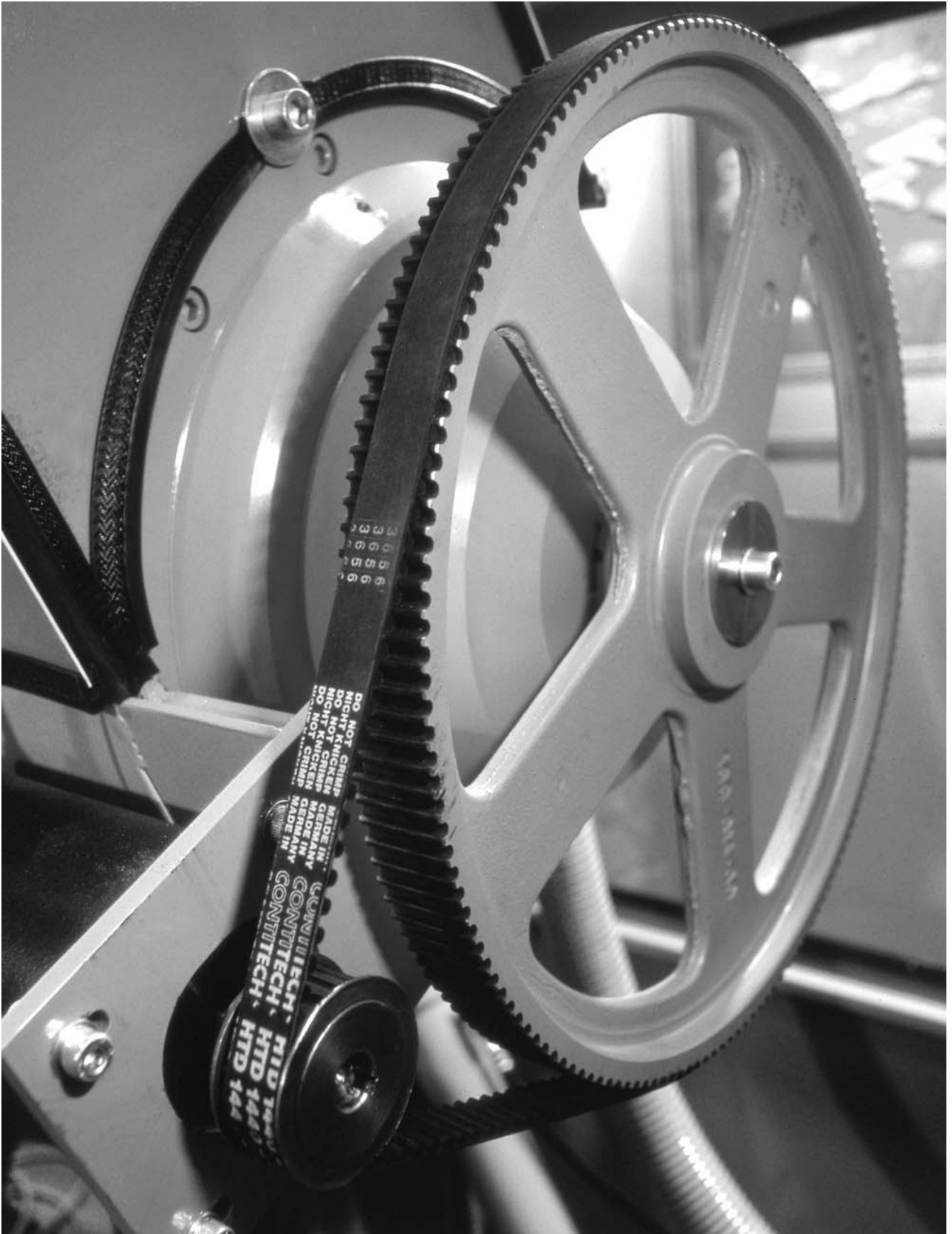

CONTI SYNCHROBELT® HTD synchronous drive belt on a grinding machine.

Assembly and Storage

CONTI SYNCHROBELT® HTD synchronous drive belts are precision products characterized by a long service life and a high degree of safety and operational reliability. Provided the correct design layout of the drive is made and a proper assembly and storage allowed, CONTI SYNCHROBELT® HTD drives are free of maintenance.

The following recommendations will help you to fully utilize all the advantages of CONTI SYNCHROBELT® HTD synchronous drive belts and toothed pulleys.

Assembly

The toothed pulleys must have the same pitch as the synchronous drive belts. They shall be free from burrs, rust and dirt and be precisely aligned prior to mounting of the belt.

Assembly shall be effected manually without any application of force. The centre distance is to be reduced for this purpose. If this is not possible, the synchronous drive belt and one or both toothed pulleys must be mounted at the same time. By no means is it allowed to force synchronous drive belts onto the toothed pulley or over the flanged pulleys or to use an assembling tool, because the tensile member may become damaged.

The tension depends on the power to be transmitted and on the drive characteristics. The positive transmission of power requires a relatively low tension. A means of adjustment, e.g. adjustable centre distance, should be provided to adjust the tension as well as to compensate the tolerances of the synchronous drive belt, toothed pulleys and the centre distance.

- Excessive tension causes louder running noises and premature belt wear.
- Insufficient tension results in an irregular running condition and may result in tooth jump.

The section "Design Data" (page 35) contains recommendations for the determination of the tension.

No maintenance is required under normal operating conditions.

Storage

CONTI SYNCHROBELT® HTD synchronous drive belts shall be stored in accordance with DIN 7716 – General Instructions for Storing, Cleaning and Servicing Products of Natural and Synthetic Rubber. The storage room shall be cool, dry and ventilated in a dust-free manner and shall have a temperature of 15 to 20 °C.

Storage may be by stacking or hanging on so-called "saddles" or on largediameter pipes. Deformations due to excessive stacking heights or to suspending the material to nails or hooks are inadmissible.

CONTI SYNCHROBELT® HTD synchronous drive belts must not be kinked or buckled, otherwise the length-stable glass-cord tensile member may become damaged.

A

Abrasion resistant _____ 8
 Acceleration factor _____ 37, 45
 Ageing resistance _____ 8
 Assembling tool _____ 78
 Assembly _____ 78
 Available range
 synchronous drive belts ___ 9–14
 Axle and bearing load _____ 7
 Axial runout _____ 31

B

Balancing _____ 32
 Belt deflection _____ 44, 47
 length _____ 10–14, 42
 45
 speed _____ 6, 43, 45
 storage _____ 78
 thickness _____ 17
 top _____ 8
 wear _____ 78
 width _____ 17, 43, 46
 Belt side force, static _____ 43
 Belt side inclination angle _____ 35
 Bending load _____ 43

C

Calculation _____ 34–44
 example _____ 45–47
 Centre distance _____ 15, 41, 42
 46
 Centre distance factor _____ 41, 42
 63–75
 Circumferential speed _____ 32
 Construction _____ 8
 Corrosion _____ 7

D

Design of toothed pulleys _____ 20
 data _____ 20–32
 Designation
 of synchronous drive
 belts _____ 9
 of toothed pulleys _____ 21
 Driven machines _____ 36

E

Effective pull, permissible _____ 40
 Efficiency _____ 7
 Elastomer materials _____ 8

F

Facing fabric _____ 6, 8
 Fatigue factor _____ 37, 45
 failure resistance _____ 8
 Finished bore of toothed
 pulleys _____ 23–26
 Flanged pulleys _____ 20
 diameter _____ 20, 23–26
 pressed _____ 20
 screwed on _____ 20
 thickness _____ 20
 Flexing frequency _____ 37
 Frequency measuring
 method _____ 44, 47
 Friction coefficient _____ 8

G

Glass tension cord _____ 8

H

Heavy-duty drives _____ 6
 HTD – High Torque Drive _____ 4

I

Intermittent operation _____ 37
 Interrelation
 synchronous drive belt width
 pulley width _____ 23–26
 Irregular running _____ 78
 ISO 254 _____ 32
 Isochromates _____ 5

L

Length designation _____ 10–14
 factor _____ 37, 46
 measurement _____ 15
 stability _____ 8
 tolerance _____ 17
 Lengths available _____ 10–14
 Load distribution _____ 5
 factor _____ 36, 45
 Low elongation _____ 8
 Low-noise running _____ 7
 Lubrication _____ 7

M

Maintenance _____ 7, 78
 Material for toothed pulleys 20
 selection _____ 20
 Means of adjustment _____ 78
 Measurement of
 synchronous drive belts _____ 15
 Measuring equipment _____ 15
 force _____ 15, 16
 pulleys _____ 15, 16
 Meshing teeth, number of _____ 35
 of teeth _____ 7, 20

N

Number of teeth _____ 9, 21, 40

O

Oil-resistant _____ 7
 Operating conditions _____ 36, 37
 Operation. period of _____ 37
 type of _____ 36
 Outside diameter _____ 22, 23–30
 tolerances for _____ 31
 Overall circumference _____ 9
 Load factor _____ 36
 tension _____ 43, 46
 Ozone-resistant _____ 7

P

Parallelism _____ 31
 Pitch _____ 9, 21
 circumference _____ 15
 diameter _____ 21, 23–30
 40, 45
 length _____ 9, 15, 42
 45
 line _____ 9, 21
 line distance _____ 21
 Polyamide fabric _____ 8
 Polychloroprene _____ 8
 Power _____ 38
 rating _____ 44, 48–62
 Preferred sizes for toothed
 pulleys _____ 23–26
 tension _____ 43, 46
 Pull, effective _____ 40, 47
 Pulley diameters _____ 20, 23–30
 width _____ 21, 23–26

R

Radial runout _____ 31
 Retensioning _____ 7

S

Safety factors _____ 35
Saddles _____ 78
Selection of the synchronous
drive belt pitch _____ 38, 39
Space requirements _____ 6
Specification index for
toothed pulleys _____ 22
Speed _____ 43
ratio _____ 37, 40, 45
Stable in length _____ 7
Stacking heights _____ 78
Standard construction _____ 8
lengths _____ 10–14
widths _____ 10–14
Stock bore of toothed
pulleys _____ 23–26
Storage _____ 78
room _____ 78
Symbols _____ 34
Synchronism _____ 6
Synchronous drive belt
designation _____ 8
drive belt length _____ 10–14, 16
42, 45
drive belt tension _____ 6, 44, 47
drive belt width _____ 9, 10–14
17

T

Taper _____ 31
Teeth in mesh factor _____ 35, 45
Temperature in the
storage room _____ 78
resistance _____ 7
Tensile member _____ 4, 8
Tension _____ 43, 46
Tensioning excessive _____ 78
insufficient _____ 78
Terms _____ 34
Thickness tolerance _____ 17
Tolerances synchronous
drive belts _____ 17
toothed pulleys _____ 31
Tooth deformation _____ 4
design _____ 5, 6
jump _____ 6
pitch _____ 9
profile _____ 4, 9–14
Toothed pulleys _____ 20–32
pulley designation _____ 21
pulley width _____ 21, 23–26
Toothing width _____ 23–26
Transmission ratio _____ 37, 40, 45
Trapezoidal tooth _____ 5
Tropics-resistant _____ 7

U

Units _____ 34

V

VDI recommendation 2060 _ 32

W

Weathering influences _____ 7
Widths available _____ 9
tolerance _____ 17
Wrap angle _____ 40, 46

ContiTech Antriebssysteme GmbH
Postfach 445, D-30004 Hannover
Philipsbornstraße 1, D-30165 Hannover
Phone + 49 (0) 511 / 9 38-71
Fax + 49 (0) 511 / 9 38-52 37
E-Mail: industrie.as@antriebssysteme.contitech.de
www.contitech.de/antriebssysteme

ContiTech Antriebssysteme GmbH
Continentalstraße 1, D-29451 Dannenberg
Phone +49 (0) 58 61 / 8 06-0
Fax + 49 (0) 58 61 / 8 06-302
E-Mail: dannenberg@antriebssysteme.contitech.de

The contents of this publication are the result of many years of research and experience gained in application technology. All information is given in good faith; it does not represent a guarantee with respect to characteristics and does not exempt the user from testing the suitability of products and from ascertaining that the industrial property rights of third parties are not violated. No liability whatsoever will be accepted for damage – regardless of its nature and its legal basis – arising from advice given in this pub-

lication. This does not apply in the event that we or our legal representatives or management are found guilty of having acted with intent or gross negligence. No liability is borne for damage due to ordinary negligence. This exclusion of liability applies also to the personal liability of our legal representatives and employees and other persons employed in performing our obligations.
©2002 by ContiTech Holding GmbH, Hannover.
All rights reserved.