















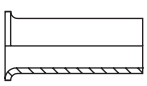
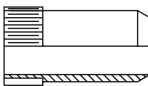
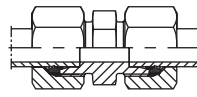
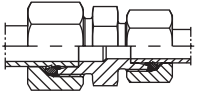
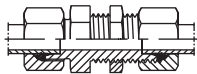
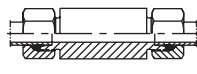
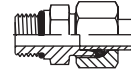
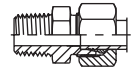
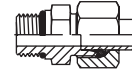
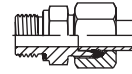

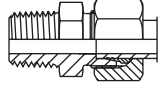
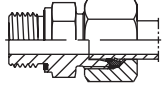

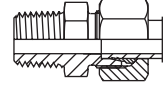
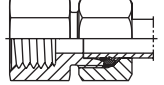

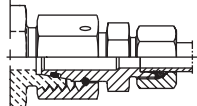
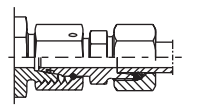
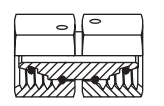
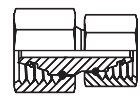
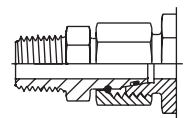
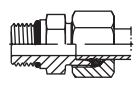
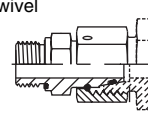
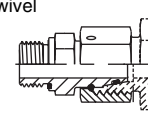
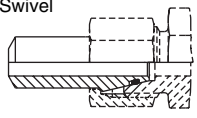
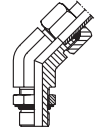
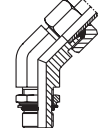
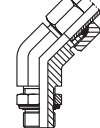
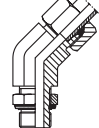
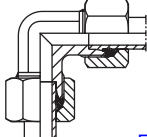
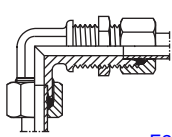
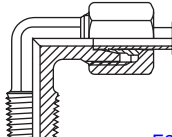
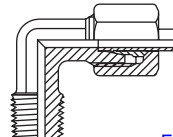
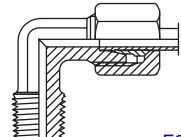

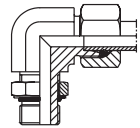
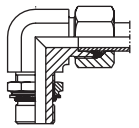
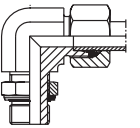
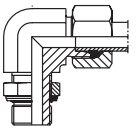
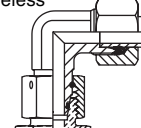
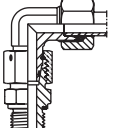
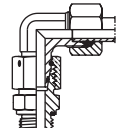
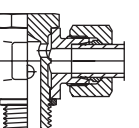
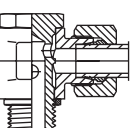
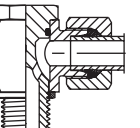
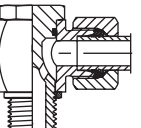
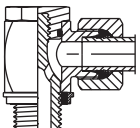
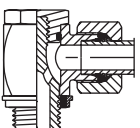
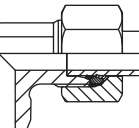

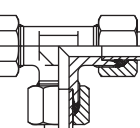
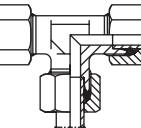
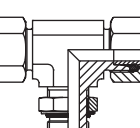
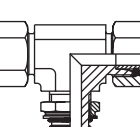
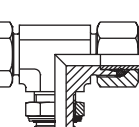
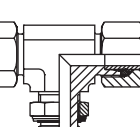
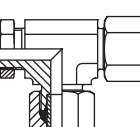
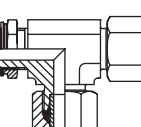
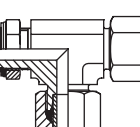
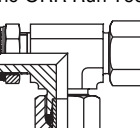
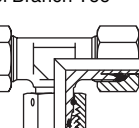
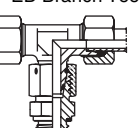
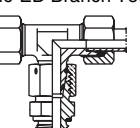
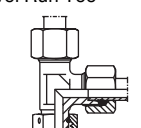
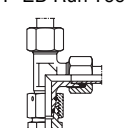
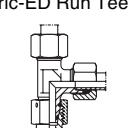
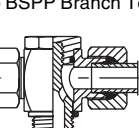
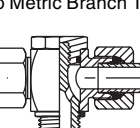
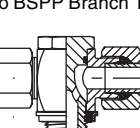
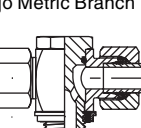

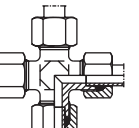

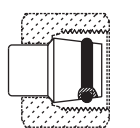
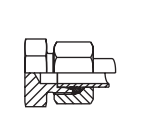

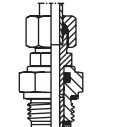
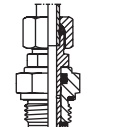
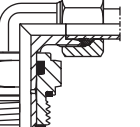
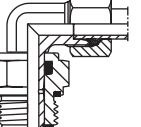



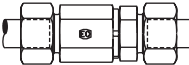
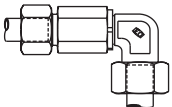
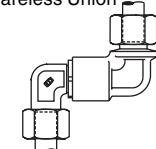
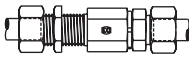
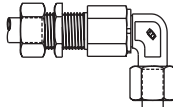
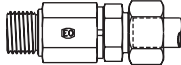
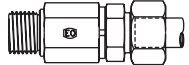
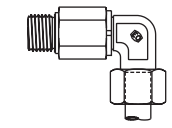
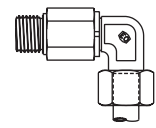
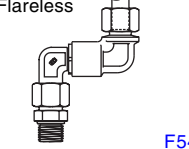
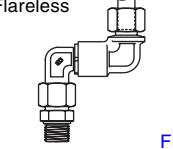

EO and EO-2 Metric Bite Type Fittings

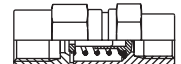
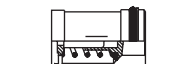

The Fitting Authority

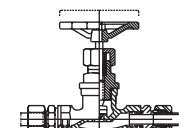
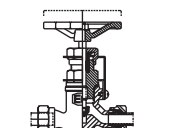
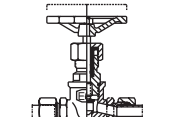
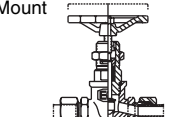
<p>Nuts, Sleeves, Locknut, Inserts</p>	<p>M Nut</p>  <p>F12</p>	<p>FM Functional Nut</p>  <p>F13</p>	<p>DPR Progressive Ring</p>  <p>F12</p>	<p>D Cutting Ring</p>  <p>F12</p>	<p>PSR Progressive Ring</p>  <p>F12</p>
<p>GM Bulkhead Locknut</p>  <p>F14</p>	<p>E Insert for Plastic Tube</p>  <p>F14</p>	<p>VH Insert for Metal Tube</p>  <p>F14</p>	<p>Straights</p>	<p>G Union</p>  <p>F15</p>	<p>GR Reducer Union</p>  <p>F15</p>
<p>SV Bulkhead Union</p>  <p>F16</p>	<p>ESV Weld Bulkhead Union</p>  <p>F16</p>	<p>GE-UNF/UN SAE-ORB / Flareless</p>  <p>F17</p>	<p>GE-NPT NPT / Flareless</p>  <p>F17</p>	<p>GEO ISO 6149 / Flareless</p>  <p>F18</p>	<p>GE-R-ED BSPP-ED / Flareless</p>  <p>F18</p>
<p>GE-R BSPP / Flareless</p>  <p>F19</p>	<p>GE-R keg BSPT / Flareless</p>  <p>F19</p>	<p>GE-M-ED Metric-ED / Flareless</p>  <p>F20</p>	<p>GE-M Metric / Flareless</p>  <p>F21</p>	<p>GE-M keg Metric Taper / Flareless</p>  <p>F21</p>	<p>GAI-R Female BSPP / Flareless</p>  <p>F21</p>
<p>GAI-M Female Metric / Flareless</p>  <p>F22</p>	<p>AS Butt Weld / Flareless</p>  <p>F22</p>	<p>Straight Swivels</p>	<p>RED Tube End Reducer</p>  <p>F23</p>	<p>DA Extender</p>  <p>F24</p>	<p>GZ Swivel Union</p>  <p>F24</p>
<p>GZR Swivel Union Reducer</p>  <p>F24</p>	<p>EGE-NPT NPT / Flareless Swivel</p>  <p>F24</p>	<p>EGEO ISO 6149 / Flareless Swivel</p>  <p>F25</p>	<p>EGE-R-ED BSPP-ED / Flareless Swivel</p>  <p>F25</p>	<p>EGE-M-ED Metric-ED / Flareless Swivel</p>  <p>F25</p>	<p>SKA Butt Weld / Flareless Swivel</p>  <p>F25</p>
<p>45° Elbows</p>	<p>VEE-UNF/UN SAE-ORB / Flareless</p>  <p>F26</p>	<p>VEE-OR ISO 6149 / Flareless</p>  <p>F26</p>	<p>VEE-R BSPP-ORR / Flareless</p>  <p>F27</p>	<p>VEE-M Metric-ORR / Flareless</p>  <p>F27</p>	
<p>90° Elbows</p>	<p>W Union Elbow</p>  <p>F28</p>	<p>WSV Bulkhead Union Elbow</p>  <p>F29</p>	<p>WE-NPT NPT / Flareless</p>  <p>F29</p>	<p>WE-R keg BSPT / Flareless</p>  <p>F30</p>	<p>WE-M keg Metric Taper / Flareless</p>  <p>F30</p>

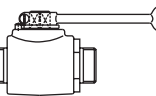
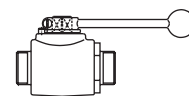
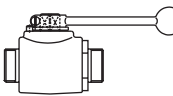

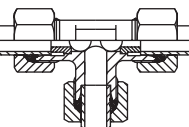
<p>WEE-UNF/UN SAE-ORB / Flareless</p>  <p>F31</p>	<p>WEE-OR ISO 6149 / Flareless</p>  <p>F31</p>	<p>WEE-R BSPP-ORR / Flareless</p>  <p>F32</p>	<p>WEE-M Metric-ORR / Flareless</p>  <p>F32</p>	<p>EW Flareless Swivel / Flareless</p>  <p>F33</p>	<p>EW-R-ED BSPP-ED / Flareless</p>  <p>F34</p>	
<p>EW-M-ED Metric-ED / Flareless</p>  <p>F34</p>	<p>SWVE-R Banjo BSPP / Flareless</p>  <p>F35</p>	<p>SWVE-M Banjo Metric / Flareless</p>  <p>F35</p>	<p>WH-R Banjo BSPP / Flareless</p>  <p>F36</p>	<p>WH-M Banjo Metric / Flareless</p>  <p>F36</p>	<p>WH-R-KDS Banjo BSPP / Flareless</p>  <p>F37</p>	
<p>WH-M-KDS Banjo Metric / Flareless</p>  <p>F37</p>	<p>WAS Butt Weld / Flareless</p>  <p>F38</p>	<p>Tees</p> 		<p>T Union Tee</p>  <p>F38</p>	<p>TR Reducer Tee</p>  <p>F39 - F40</p>	<p>TEE-UNF/UN SAE-ORB Branch Tee</p>  <p>F40</p>
<p>TEE-OR ISO 6149 Branch Tee</p>  <p>F41</p>	<p>TEE-R BSPP-ORR Branch Tee</p>  <p>F41</p>	<p>TEE-M Metric-ORR Branch Tee</p>  <p>F42</p>	<p>LEE-UNF/UN SAE-ORB Run Tee</p>  <p>F42</p>	<p>LEE-OR ISO 6164 Run Tee</p>  <p>F43</p>	<p>LEE-R BSPP-ORR Run Tee</p>  <p>F43</p>	
<p>LEE-M Metric-ORR Run Tee</p>  <p>F43</p>	<p>ET Swivel Branch Tee</p>  <p>F44</p>	<p>ET-R-ED BSPP-ED Branch Tee</p>  <p>F44</p>	<p>ET-M-ED Metric-ED Branch Tee</p>  <p>F45</p>	<p>EL Swivel Run Tee</p>  <p>F45</p>	<p>EL-R-ED BSPP-ED Run Tee</p>  <p>F46</p>	
<p>EL-M-ED Metric-ED Run Tee</p>  <p>F46</p>	<p>TH-R Banjo BSPP Branch Tee</p>  <p>F47</p>	<p>TH-M Banjo Metric Branch Tee</p>  <p>F47</p>	<p>TH-R-KDS Banjo BSPP Branch Tee</p>  <p>F48</p>	<p>TH-M-KDS Banjo Metric Branch Tee</p>  <p>F48</p>		
<p>Cross</p> 		<p>K Union Cross</p>  <p>F49</p>	<p>Caps and Plugs</p> 		<p>VKA Flareless Cap</p>  <p>F49</p>	<p>ROV Flareless Plug</p>  <p>F49</p>
<p>Plain Bearing Rotary Fittings</p> 		<p>DVGE-R BSPP-ED / Flareless</p>  <p>F50</p>	<p>DVGE-M Metric-ED / Flareless</p>  <p>F51</p>	<p>DVWE-R BSPP-ED / Flareless</p>  <p>F50</p>	<p>DVWE-M Metric-ED / Flareless</p>  <p>F51</p>	

<p>Ball Bearing Rotary Fittings</p> 	<p>DG101 Flareless Union</p>  <p>F52</p>	<p>DG103 Flareless Union</p>  <p>F52</p>	<p>DG105 Flareless Union</p>  <p>F52</p>	<p>DG107 Union Bulkhead</p>  <p>F52</p>	<p>DG108 90° Union Bulkhead</p>  <p>F53</p>
<p>DG102-R BSPP-ED / Flareless</p>  <p>F53</p>	<p>DG102-M Metric-ED / Flareless</p>  <p>F53</p>	<p>DG104-R 90° BSPP-ED / Flareless</p>  <p>F53</p>	<p>DG104-M 90° Metric-ED / Flareless</p>  <p>F54</p>	<p>DG106-R Double Elbow BSPP / Flareless</p>  <p>F54</p>	<p>DG106-M Double Elbow Metric / Flareless</p>  <p>F54</p>
<p>Check Valves</p> 	<p>RHD Union</p>  <p>F55</p>	<p>RHV-R-ED BSPP-ED / Flareless</p>  <p>F55</p>	<p>RHV-M-ED Metric-ED / Flareless</p>  <p>F56</p>	<p>RHZ-R-ED BSPP-ED / Flareless</p>  <p>F56</p>	<p>RHZ-M-ED Metric-ED / Flareless</p>  <p>F57</p>
<p>RHDI Female BSPP Union</p>  <p>F57</p>	<p>RVP Cartridge</p>  <p>F58</p>	<p>I-TL Internal Parts</p>  <p>F58</p>	<p>Shut-Off Valves</p> 	<p>DV Low Pressure</p>  <p>F59</p>	<p>LD Medium Pressure</p>  <p>F59</p>
<p>VDHA High Pressure</p>  <p>F60</p>	<p>VDHB High Pressure – Panel Mount</p>  <p>F60</p>	<p>Ball Valves</p> 	<p>KH 2-Way Flareless Union</p>  <p>F61</p>	<p>KH-NPT 2-Way Female NPT</p>  <p>F62</p>	<p>KH-R 2-Way Female BSPP</p>  <p>F62</p>
<p>Alternating Valves</p> 	<p>WV Union Tee</p>  <p>F62</p>				

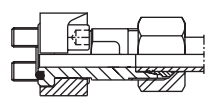
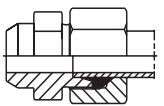
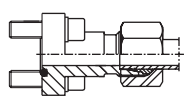
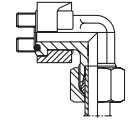
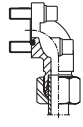



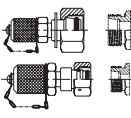
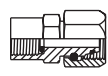
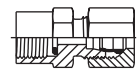

Flange Adapters (Shown in Section M)

 <p>Flange Adapters</p>	<p>GFS Code 61, 62 / Metric Flareless</p>  <p>M11</p>	<p>AS Code 61, 62 / Weld Butt – Tube Metric</p>  <p>M23</p>	<p>BFG DIN Flange / Metric Flareless</p>  <p>M12</p>	<p>WFS Code 61, 62 / Metric Flareless</p>  <p>M30</p>	<p>BFW DIN Flange / Metric Flareless</p>  <p>M31</p>
---	---	---	---	---	--

Diagnostic and Specialty Adapters (Shown in Section N)

 <p>Test Point Connectors</p>	<p>GMA3 EO Tube / EO Tube / EMA-3 Diagnostic Tip</p>  <p>N5</p>	<p>VKA3 EO Swivel / Diagnostic Tip</p>  <p>N10</p>	<p>MAVE BSPP Gauge / EO Swivel</p>  <p>N7</p>	<p>MAV BSPP Gauge / EO Tube</p>  <p>N7</p>
---	---	--	---	--

O-Rings and Seals (Shown in Section O)

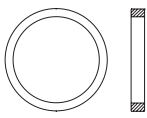
 <p>O-Rings and Seals</p>	<p>Bonded Seal for Banjo Fittings</p>  <p>O7</p>	<p>Metal Seal for Banjo Fittings</p>  <p>O7</p>	<p>Pressure Gauge Sealing Ring</p>  <p>O8</p>	<p>Elastic Seal Ring</p>  <p>O5</p>	<p>EO O-Ring</p>  <p>O8</p>
	<p>EO-2 Sealing Ring</p>  <p>O6</p>	<p>Metric Retaining Ring</p>  <p>O4</p>			

EO Progressive Ring Fittings — Introduction

The flareless bite type fitting was pioneered by Ermeto in Germany in the early 1930's. When Parker Hannifin acquired Ermeto, it introduced the EO fittings to the US. Today, the EO fittings are the most widely used bite type fittings in the world.

The EO progressive ring fitting is a flareless metric fitting (for metric tube) that consists of a body, a progressive ring (ferrule) and a nut. On assembly, two cutting edges of the progressive ring "bite" into the outer surface of the tube ensuring the necessary holding power and seal for high operating pressures.



Fig. H1 — EO fitting components: Body, progressive ring and nut

The fittings and components listed in this catalog are intended solely for the assembly of connections for fluid applications.

Three series of EO tube fittings (LL, L and S) and accessories are manufactured in accordance with DIN 2353 (summary) on the basis of decades of experience.*

To ensure functional safety of EO tube fittings, only EO parts should be used in their assembly. Routing of tubes should be carried out in accordance with Parker/EO recommended practices. Assembly instructions are available.

Design and Construction

The three components of EO fittings are designed and manufactured to produce a strong, reliable, leak-free joint upon proper assembly.

The EO Body. EO fitting bodies are available in over thirty configurations. The shaped products (i.e., elbows, tees, crosses) are hot forged, then machined to the stringent EO fitting specifications. The forging process used by Parker further improves the strength and metallurgical properties of the fitting material.

Straight products are made from cold drawn bar stock. The cold drawing operation ensures consistently tight dimensional tolerances, as well as significantly improved strength.

The EO Progressive Ring (Cutting Ring). EO progressive rings are precision machined with all dimensions and surfaces, particularly the critical bite edges, monitored on an ongoing basis. The rings are then heat treated in a manner that provides the hardness, strength, and toughness necessary to satisfy the

demanding service conditions that exist in industry today. The original progressive ring, known as DPR, is now being replaced with the new generation, called PSR. PSR is stronger and features a "positive stop" to eliminate over-tightening.

The EO Nut. EO fitting nuts are either cold formed, hot formed or machined from cold drawn material. The cold forming and cold drawing operations provide a more tightly packed grain structure, thus improving the material's strength. In addition, cold forming significantly improves the fatigue properties or endurance limits of the nuts.

Standard Material Specifications

Steel fittings:

EO tube fittings – Materials according to DIN 3859-1

Stainless steel fittings:

EO tube fittings – X6CrNiMoTi 17122 in accordance with DIN 17440 / EN 10088, material no. 1.4571.

Brass fittings:

EO tube fittings – CUZN35Ni2 in accordance with DIN 17660, material no. 2.0540.

Elastomer seals: NBR (BUNA-N), FPM (Fluorocarbon)

Surface Finish - Steel fittings:

Standard		
LL Series	Body, Nuts, and Rings	– Zinc yellow chromate
L+S Series	Body and Nuts	– Zinc yellow chromate
	Progressive Rings (DPR)	– Zinc olive chromate
	Progressive Rings (PSR)	– Zinc clear chromate

Short codes for surface protection procedure in accordance with DIN 267 part 9 or DIN 50942.

How EO Fittings Work: Function of Progressive Ring Fittings

The EO progressive ring fitting produces a low to high pressure, leak free connection of tubes and components in fluid systems. The basic function of the EO progressive ring is the controlled progressive bite of the ring into the tube due to a unique internal geometry.

The front cutting edge has already started cutting into the tube before the second cutting edge starts. As soon as both cutting edges have cut the tube to the designed depth further advance is limited by the stop edge.

Owing to the design of both cutting edges and stop edge all forces arising are equally distributed. This distribution along with the specially designed interior collar of the ring guarantees increased safety, particularly with regard to vibration and flexure stresses. The design and function of the progressive cutting ring ensure that service vibration loading is not present in the areas of the tubing where the bite is made.

*The selection of LL, L or S design should be made by the user on the basis of intended system pressure. The pertinent maximum recommended working pressures are shown throughout this catalog in individual data charts of the various fitting configurations.

The stop edge causes a sharp increase in tightening forces which is clearly perceptible. After assembly, a visible collar of cut tube material must completely fill the space in front of the first cutting edge. With stainless steel tube and hose connections made from free cutting steel, the collar is less due to the harder material.

During assembly, it is absolutely essential that the tube is held firmly against the stop in the inner cone of the fitting; if not, the cutting process will not take place satisfactorily. Reassembly can be performed an unlimited number of times.

Weld Nipples

EO weld nipple fittings with an O-ring seal between weld nipple and body give impressive tear out resistance and sealing integrity, and a sensible supplement to the progressive ring. Fittings bodies and nuts are fully interchangeable for weld nipple and progressive ring fittings of the same series and tube outside diameter. Weld nipples SKA conform to DIN 3865 form A.

Ball Bearing Rotary Fittings

DG Ball Bearing Rotary Fittings: These compact, maintenance-free construction, service proven fittings combine ball and plain bearings with constant lubrication and relatively wear resistant annular piston seals. They are rated for working pressures up to 250 bar, have a low starting torque and have a suitable pressure/RPM rate.

Ball bearing rotary fittings are designed for connecting a fixed point to a rotating, swiveling or moving machine part via tubing or hoses. Thus axial torsion of tubing or hoses can be prevented. They are suitable for hydraulic oils and lubricants of mineral oil base, not suitable for water or gases. Nominal temperature range is -35°C to +80°C.

Fitting Instructions:

The life of rotary fitting depends considerably in a stress-free line connection. Therefore, the direct connection with tube is to be avoided. For connection to hoses the use of swivel nut fittings is recommended with short, straight lines (approx. length 5x hose O.D.). Thus shocks and vibrations can be absorbed.

Assemble tube ends in accordance with the Tube End Assembly Information on [pages T9 through T10](#). Assemble BSPP and metric stud ends in accordance with torque values on [page T7](#).

Plain Bearing Rotary Fittings

Plain Bearing Rotary Fittings: These compact, maintenance-free construction, service proven fittings are rated for low pressure tube and hose with slow rotating, swiveling or moving machine parts up to 64 bar (L series) and 160 bar (S series).

Plain bearing rotary fittings are designed for connecting a fixed point to a rotating, swiveling or moving machine part via tubing or hoses. Thus axial torsion of tubing or hoses can be prevented. They are suitable for hydraulic oils and lubricants of mineral oil base, not suitable for water or gases. Nominal temperature range is -35°C to +100°C.

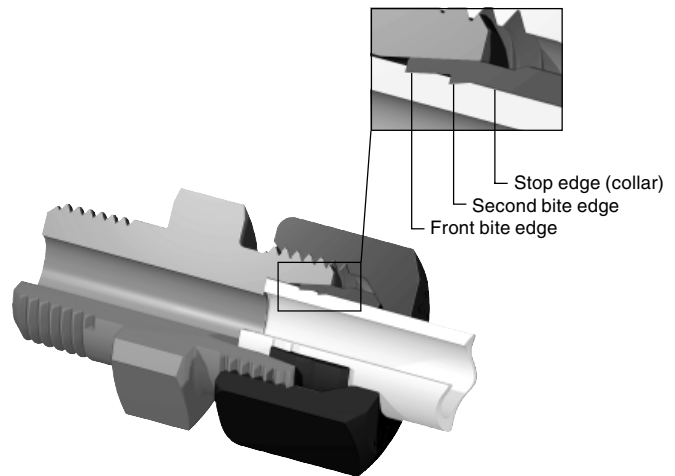

Fig. F2 — How EO fittings work

Tube O.D.	Nominal bore (mm)	Permissible number of revolutions (rpm) under a working pressure** of:					Torque at 250 bar/Nm
		25 bar	64 bar	100 bar	160 bar	250 bar	
6 8	4 6	1500	750	400	200	85	0.08
12 16	10 13	800	400	200	100	45	0.24
20 25	16 20	300	150	75	38	15	0.8
30 38	25 30	200	100	50	25	10	2.0

Table F1 — Ball Bearing Recommended RPM and Starting Torques

**A minimum working pressure of 10 bar is necessary.

Series L Tube O.D.	6	8	10	12	15	18	22	28	35	
Permissible RPM	28	28	21	17	13	10	10	7	7	
Series S Tube O.D.	6	8	10	12	14	16	20	25	30	38
Permissible RPM	11	11	9	7	5	5	4	4	3	3

Table F2 — Plain Bearing Recommended RPM

Fitting Instructions:

The life of a rotary fitting depends considerably in a stress-free line connection. Therefore, the direct connection with tube is to be avoided. For connection to hoses, the use of swivel nut fittings is recommended with short, straight lines (approx. length 5x hose O.D.). Thus, shocks and vibrations can be absorbed.

Non-Return Valves

Characteristics: Sealing is achieved by using a 90° cone with a packing washer of synthetic material. Valve has a lift stop which provides safe free outlet, shock-absorbing, muffled opening and no reduction of cross section. Maximum flow velocity not more than 8 m/sec (for higher flow velocities special tests are required).

Opening Pressure: Approximately 1 bar (on request also 0.5-2 and 3 bar are available. Please specify on order). Tolerance of opening pressure is $\pm 20\%$.

Tube Recommendations**For steel fittings:**

Seamless cold drawn steel tubes made from material St. 35.4 or from conditioned base material St. 37.4 in accordance with DIN 1630, state of delivery NBK (normal annealed) with tube outer and inner diameter tolerances in accordance with DIN 2391/ISO 3304. Max. hardness: HRB 75.

For stainless steel fittings:

Material no. 1.4571 and 1.4541

Seamless drawn tubes made from austenitic, stainless steel materials no. 1.4571 and 1.4541, in accordance with DIN/EN/ISO 1127. Max. hardness: HRB 90.

These tubes are particularly recommended for tube fittings, since the tube outer diameter and wall thickness, tolerances correspond to those of steel tubes in accordance with DIN 2391/ISO 3304.

For brass fittings:

Seamless drawn copper tube made from material with short code SF-Cu F37 in accordance with DIN 1786.

Tube wall thicknesses:

In order to determine the necessary tube wall thicknesses for applications, refer to the calculated pressures provided in the tables for EO metric tubing. The calculated pressures DIN 2413-I are for static and DIN 2413-III for dynamic loads.

The maximum wall thickness is based on the pressure holding capacity of the fitting. In some cases, the wall thickness of the tube might be too thin for reliable service and an insert must be used to prevent excessive tube collapse. See assembly section for recommended tube wall thicknesses.

Plastic tube:

EO fittings are suitable for use with various types of plastic tubes such as nylon, polyethylene, etc. When used with plastic tube, an insert (see [page F14](#)) must be used to prevent tube pull out due to tensile loading.

Features, Advantages & Benefits

- **Visible Bite** — The critical front bite of the progressive ring is clearly visible to tube fitters & inspectors. The presence of the recommended bite virtually eliminates any risk of catastrophic blow-off. This is a very important safety feature.
- **Sealing Capability** — EO fittings have demonstrated a remarkable ability to remain leak free under various service conditions ranging from sealing high vacuum and small molecules gases to high pressure hydraulic fluids.
- **Distributed Stresses** — Stresses due to service flexural loading are distributed at several points in the joint, thus stress concentration in the bite is minimized.
- **Vibration Control** — The rear bevel of the ferrule firmly grips tubing, thus dampening the effects of system vibration in the joint.
- **Progressive Ring Design** — The progressive ring design provides a second bite for improved reliability and higher working pressure capability. This design also decreases the risk of improper assembly because of the sharp, high torque rise which occurs when the fitting is properly tightened.
- **Envelope Size** — EO fittings are relatively small and compact, making it a suitable selection for plumbing in limited or tight space.
- **Temperature Rating** — EO fittings are suitable for sub-zero through elevated temperature applications. Service temperature rating is limited by the material chosen.
- **Compatibility** — Since EO fittings can be manufactured from a wide range of metals, its compatibility factor with various fluids and atmospheric conditions is virtually limitless. One simply has to select and specify EO fittings from an acceptable material that best satisfies the service conditions.
- **Tube Wall** — EO fittings are suitable for use with light wall, medium wall, heavy wall, and extra heavy wall tubing. (Light wall tube may require support sleeve (VH), as shown in Assembly/Installation Section.)
- **Re-Usability / Remakeability** — Joints can be disassembled and reassembled many times to facilitate system maintenance. This reduces the labor and material costs that would otherwise result from tube and fittings replacement.
- **Assembly** — No expensive, complicated tooling is necessary to assemble EO fittings. Assembly is simple when the procedures described in the Assembly / Installation section are followed (see [pages T24 - T27](#)).
- **Materials** — EO fittings can be manufactured from almost any metallic material. The more popular materials currently used for EO fittings are: stainless steel, carbon steel, and brass. On request, the Tube Fitting Division will machine EO fittings from other appropriate material specified by users.
- **Manufacture** — EO fittings are manufactured under tight quality control which ensures that the product routinely satisfies or surpasses the requirements of the pertinent industrial standards.
- **World Wide Popularity** — The bite type fitting design has worldwide acceptance and is especially popular in Europe.

- **Finish** — Steel EO fittings have a zinc gold chromate finish. This finish provides good corrosion protection.
- **Silver Plated Nuts** — Stainless steel tube nuts are pre-lubricated with silver plated threads (size 15L-42L, 12S-38S). Thread galling is eliminated and assembly torque is reduced as much as 40 percent. This increases the speed and efficiency for stainless steel fitting assembly.
- **Availability** — EO fittings are available as standard in over thirty different configurations, and as many as twenty-seven different size combinations in some configurations.
- **Configurations** — Popular configurations for EO fittings are shown in the Visual Index. Other configurations can be manufactured on request.

EO-2 Fitting System — Introduction

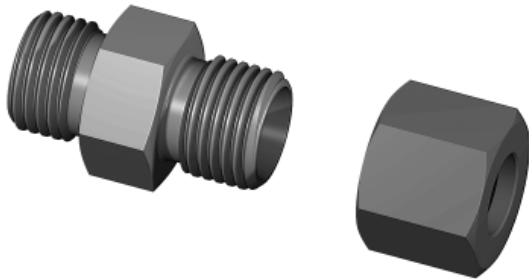

Fig. F3 — EO-2: Fitting body and functional nut

The EO-2 high pressure tube fitting generation is the most recent development of the Tube Fitting Division Europe. It was introduced in an effort to eliminate leakage in all fluid systems.

The common feature of all EO-2 fittings is elastomeric seals on all joints. This assures leakfree operation without retightening — even under severe working conditions. Another breakthrough in bite-type technology is the simple assembly and cost-saving handling of the unique EO-2 Functional Nut.

EO-2 is a true metric design according to 24° bite-type standards such as: ISO 8434-1, DIN 2353 or DIN 3861. It covers all three series (LL, L and S) of the broad EO tube fitting program.

This resulted in a great acceptance with equipment manufacturers that are targeting an absolute leakfree systems without sacrificing the convenience of using metric bite type fittings.

Design and Construction

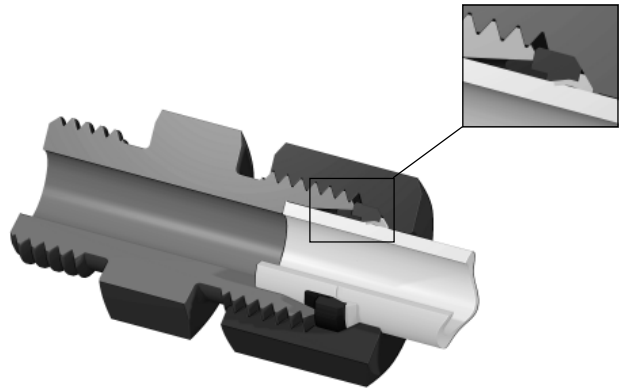

Fig. F4 — EO-2: The metallic support of the sealing ring acts just like an integrated preassembly tool.

Elastomeric Sealing

The elastomeric seal assures a hermetically sealed tube joint. It is located in between the inner cone of the fitting body and the tube surface, thus blocking the only possible leak path. Due to its large cross-section, the seal effectively compensates for all manufacturing tolerances on tube and fitting cone.

The sealing effect is pressure supported which makes the EO-2 fitting suitable for high pressure applications. The static compression also eliminates air-ingress into the fluid system at underpressure conditions.

Elastomerically sealed EO-2 fittings do not require any retightening even in heavy-duty applications. Seal extrusion is prevented by proper housing without gaps or dead volume. The sealing lip is bonded to a metallic support ring.

Standard Material Specifications

Steel fittings:

EO-2 tube fittings — Materials according to DIN 3859-1

Stainless steel fittings:

EO-2 tube fittings — X6CrNiMoTi 17122 in accordance with DIN 17440 / EN 10088, material no. 1.4571.

Brass fittings:

EO-2 tube fittings — CUZN35Ni2 in accordance with DIN 17660, material no. 2.0540.

Elastomer seals: NBR (BUNA-N), FPM (Fluorocarbon)

Surface Finish - Steel fittings:

Standard

LL Series Body, Nuts, and Rings - Zinc yellow chromate

L+S Series Body and Nuts - Zinc yellow chromate
Rings (Progressive) - Zinc olive chromate

Short codes for surface protection procedure in accordance with DIN 267 part 9 or DIN 50942.

How EO-2 Fittings Work

The retaining ring bites into the tube in accordance to the proven bite ring principle. The elastomeric seal reduces the danger of over- or underassembly by a special EO-2 design feature: Before assembly there is a gap in between the flat surfaces of the retaining ring and the metallic support ring of the seal. As soon as the retaining ring has reached the proper incision depth, the gap closes, resulting in a sharp increase of assembly torque. This results in uniform and reliable fitting assemblies. The assembly result can easily be inspected by just checking if the gap is closed.

The separation of sealing and holding functions to two separate elements finally allows a more effective solution of the over- and undertightening problems typically associated with bite type fittings.

Integrated Assembly Tool

The metallic support ring of the seal is made of a specially designed material and heat-treatment to act as an assembly tool. This makes sure that the retaining ring securely cuts into the tube surface without damaging the sensitive inner cone of the fitting body.

This unique feature of EO-2 fittings even allows direct assembly of tube without any additional pre-assembly process. An EOMAT machine (or other hydraulic tool) is strongly recommended to allow easy assembly of large dimension tube and drastically save total assembly time, effort and costs. The integrated assembly tool of EO-2 fittings even helps to save further costs and trouble when using an EOMAT-type presetting machine: As the presetting cone is only in contact with the elastomeric sealing lip, it cannot be worn out or damaged even after thousands of assemblies. This not only saves replacement costs but also avoids leakage problems caused by worn presetting tools.

The Functional Nut

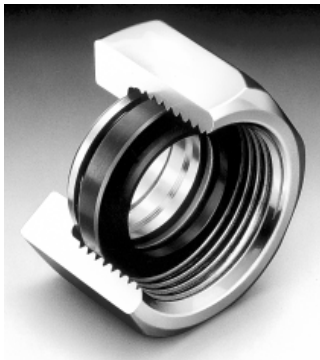

Fig. F5 — The unique Functional Nut allows easy handling and quick assembly.

The unique Functional Nut simplifies handling of fitting components and helps to minimize storage and procurement costs. The sealing and retaining rings are combined as a pair and are inserted into the internal thread of the nut in such a manner that they cannot fall out, so that these three parts form one functional element.

Individual components such as seal or retaining ring cannot be forgotten, confused or assembled in the wrong orientation. Time and cost are saved by eliminating searching and arranging the components to make up individual joints.

Functional Nuts are completely interchangeable with the full range of EO tube fitting ends.

After assembly and disassembly, the sealing ring can be replaced individually without cutting off the tube end.

Tube Recommendations

For steel fittings:

Seamless cold drawn steel tubes made from material St. 35.4 or from conditioned base material St. 37.4 in accordance with DIN 1630, state of delivery NBK (normal annealed) with tube outer and inner diameter tolerances in accordance with DIN 2391/ISO 3304. Max. hardness: HRB 75.

For stainless steel fittings: Material no. 1.4571 and 1.4541

Seamless drawn tubes made from austenitic, stainless steel materials no. 1.4571 and 1.4541, in accordance with DIN/EN/ISO 1127. Max. hardness: HRB 90.

These tubes are particularly recommended for tube fittings, since the tube outer diameter and wall thickness, tolerances correspond to those of steel tubes in accordance with DIN 2391/ISO 3304.

Tube wall thicknesses:

In order to determine the necessary tube wall thicknesses for applications, refer to the calculated pressures provided in the tables for EO metric tubing. The calculated pressures DIN 2413-I are for static and DIN 2413-III for dynamic loads.

The maximum wall thickness is based on the pressure holding capacity of the fitting. In some cases, the wall thickness of the tube might be too thin for reliable service and an insert must be used to prevent excessive tube collapse. See assembly section for recommended tube wall thicknesses.

Plastic tube:

EO-2 fittings are suitable for use with various types of plastic tubes such as nylon, polyethylene, etc. When used with plastic tube, an insert (see [page F14](#)) must be used to prevent tube pull out due to tensile loading.

Features, Advantages and Benefits of the EO-2 Fitting System

In addition to the general advantages of the EO tube fitting system, the unique EO-2 fitting features offer even more specific benefits:

- **Sealing Capability** — An elastomeric seal forms the primary sealing element, thus assuring leak-free sealing. Even low-viscosity media such as water or gas are hermetically sealed. Hydraulic systems, therefore, do not “sweat” at fittings.
- **High Pressure Resistance** — EO-2 fittings are rated up to Pmax 900 bar. Sealing lip and seal arrangements have both been designed so that the sealing effect is supported by system pressure. The interaction of the retaining ring and the integrated preassembly tool results in uniform and reliable fitting assembly.
- **Durability** — The elastomeric seal does not require any retightening even after years of operation under severe working conditions.
- **Bite Control** — The ideal bite depth is controlled by the fitting design rather than by the fitters force. Closing the gap at the end of the manual assembly, the fitter gets clear signal that setting is completed and the joint is ready for inspection.
- **Functional Nut** — Individual components such as the retaining ring or seal cannot be lost, forgotten, confused or assembled in the wrong orientation. This dramatically saves assembly cost and helps to avoid dangerous assembly errors.
- **Assembly Cost** — With less than 10 seconds cycle time on the EOMAT III/A (actual presetting process: 1.4 seconds), the cost of presetting EO-2 is extremely low.
- **Integrated Preassembly Tool** — Each EO-2 Functional Nut comes assembled with an integrated assembly tool that makes sure that the retaining ring securely cuts into the tube surface without damaging the sensitive inner cone of the fitting body. This greatly reduces the danger of tube blow-off, even when using stainless steel tube.
- **Unlimited Presetting Tool Lifetime** — When EOMAT machines are used for cost-efficient presetting, the preassembly tools do not wear out as they are only in contact with the rubber seal. This avoids dangerous blow-off which can result when traditional bite-type fittings are assembled using worn presetting tools.
- **Make-up** — From the wrench-tight position of the preset EO-2 joint, one short pull on the wrench (approx. 1/6 to 1/4 turn) gives the assembly a quick high rise to required torque. EO-2 fittings have a solid “hit-home-feel” and excellent over-torque resistance.
- **Visible Inspection** — There is no doubt if an EO-2 Functional Nut has been preset correctly or not. Inspection is as simple as checking if the gap between retaining ring and sealing ring is completely closed. The tube end does not have to be disassembled out of the fitting for bite inspection.
- **No Phantom Leaks** — Lubrication is not mandatory for the assembly of steel EO-2 fittings. The machine operator will not be irritated about lubricant coming out of the fittings once the hydraulic system gets hot.
- **Re-Usability / Remakeability** — EO-2 fittings can be disassembled and reassembled many times. There is no wear or widening of the vulnerable inner cone. Damaged seals can easily be replaced. All spare DOZ-seals are marked by size-code (e.g.: 12-L).
- **On-Site Maintenance** — For the maintenance and replacement of EO-2 fittings a set of wrenches is sufficient. Additional in line components, such as test points (GMA), ball valves (KH) or T-fittings can be added to an existing assembly within minutes.
- **Interchangeability** — The EO-2 Functional Nut can be used for the whole variety of the broad range of more than 50 configurations in some 25 sizes of standard EO LL, L and S-series fittings. Changeover from Progressive ring or weld nipple is easy by the simple use of EO-2 Functional Nuts.
- **Reliability** — Millions of EO-2 fittings are working trouble-free in applications like: Mobile construction equipment, stationary machine tools, hydraulic presses, plastic injection molding machines, shipbuilding, offshore exploration, submarines, railway trains and military equipment. Leakage does not occur on EO-2 pipework.
- **Trouble-Free** — Regular bite type fittings allow typical assembly-errors such as: confusion of bite type ring material and size. Also, the use of worn-out preassembly tool may result in fitting failure. The clever EO-2 design eliminates most of these mistakes without making the assembly process more complicated.
- **Popularity** — EO-2 fittings are as easy to assemble as traditional bite type fittings, but they eliminate most of their typical assembly problems. EO-2 fittings are therefore appreciated by an increasing number of original equipment manufacturers. EO-2 also has become the fitting of choice of end-users that appreciate the leakfree performance, the easy maintenance and the global availability of the metric soft-seal bite type system.

M
Nut

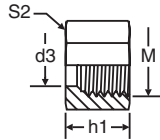

STANDARD FROM STOCK			d3 TUBE O.D. (mm)	M Metric Thread	S2 (mm)	h1 (mm)
TUBE FITTING PART #						
STEEL	STAINLESS	BRASS				
M04LLA3CX	M04LL71X	M04LLMSX	4	M8 x 1	10	11.0
M06LLA3CX	M06LL71X	M06LLMSX	6	M10 x 1	12	11.5
M08LLA3CX	M08LL71X	M08LLMSX	8	M12 x 1	14	13.0
M10LLA3CX	—	M10LLMSX	10	M14 x 1	17	13.0
M12LLA3CX	—	M12LLMSX	12	M16 x 1	19	13.0
M06LA3CX	M06LEODURX	M06LMSX	6	M12 x 1.5	14	15.0
M08LA3CX	M08LEODURX	M08LMSX	8	M14 x 1.5	17	15.0
M10LA3CX	M10LEODURX	M10LMSX	10	M16 x 1.5	19	16.0
M12LA3CX	M12LEODURX	M12LMSX	12	M18 x 1.5	22	16.0
M15LA3CX	M15LEODURX	M15LMSX	15	M22 x 1.5	27	17.5
M18LA3CX	M18LEODURX	M18LMSX	18	M26 x 1.5	32	18.5
M22LA3CX	M22LEODURX	M22LMSX	22	M30 x 2	36	20.5
M28LA3CX	M28LEODURX	M28LMSX	28	M36 x 2	41	21.0
M35LA3CX	M35LEODURX	M35LMSX	35	M45 x 2	50	24.0
M42LA3CX	M42LEODURX	M42LMSX	42	M52 x 2	60	24.0
M06SA3CX	M06SEODURX	M06SMSX	6	M14 x 1.5	17	17.0
M08SA3CX	M08SEODURX	M08SMSX	8	M16 x 1.5	19	17.0
M10SA3CX	M10SEODURX	M10SMSX	10	M18 x 1.5	22	18.0
M12SA3CX	M12SEODURX	M12SMSX	12	M20 x 1.5	24	18.0
M14SA3CX	M14SEODURX	M14SMSX	14	M22 x 1.5	27	21.0
M16SA3CX	M16SEODURX	M16SMSX	16	M24 x 1.5	30	21.0
M20SA3CX	M20SEODURX	M20SMSX	20	M30 x 2	36	24.5
M25SA3CX	M25SEODURX	M25SMSX	25	M36 x 2	46	27.0
M30SA3CX	M30SEODURX	M30SMSX	30	M42 x 2	50	29.0
M38SA3CX	M38SEODURX	M38SMSX	38	M52 x 2	60	32.5

PSR

Progressive Ring
For L and S series only

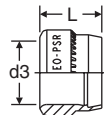

STANDARD FROM STOCK	d3 TUBE O.D. (mm)	L (mm)
TUBE FITTING PART #		
STEEL		
PSR06LX*	6	9.5
PSR08LX*	8	9.5
PSR10LX*	10	10.5
PSR12LX*	12	10.0
PSR15LX	15	10.0
PSR18LX	18	10.0
PSR22LX	22	10.5
PSR28LX	28	10.5
PSR35LX	35	13.5
PSR42LX	42	13.5
PSR14SX	14	10.0
PSR16SX	16	10.5
PSR20SX	20	12.5
PSR25SX	25	12.5
PSR30SX	30	13.0
PSR38SX	38	13.5

* PSR Progressive Rings in sizes 6, 8, 10 and 12mm are the same for both Series L and S.

PSR Progressive Rings: Zinc plated and clear chromated

DPR

Progressive Ring
For L and S series only

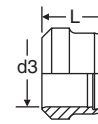

DPR:
Progressive Ring



D:
Cutting Ring

D

Cutting (Locking) Ring
For LL series only

STANDARD FROM STOCK			d3 TUBE O.D. (mm)	L (mm)
TUBE FITTING PART #				
STEEL	STAINLESS	BRASS		
D04LLX	D04LL71X	D04LLMSX	4	6.0
D06LLX	D06LL71X	D06LLMSX	6	7.0
D08LLX	D08LL71X	D08LLMSX	8	7.0
D10LLX	—	D10LLMSX	10	7.0
D12LLX	—	D12LLMSX	12	7.5
DPR06LX*	DPR06L71X*	D06LMSX*	6	9.5
DPR08LX*	DPR08L71X*	D08LMSX*	8	9.5
DPR10LX*	DPR10L71X*	D10LMSX*	10	10.5
DPR12LX*	DPR12L71X*	D12LMSX*	12	10.0
DPR15LX	DPR15L71X	D15LMSX	15	10.0
DPR18LX	DPR18L71X	D18LMSX	18	10.0
DPR22LX	DPR22L71X	D22LMSX	22	10.5
DPR28LX	DPR28L71X	D28LMSX	28	10.5
DPR35LX	DPR35L71X	D35LMSX	35	13.5
DPR42LX	DPR42L71X	D42LMSX	42	13.5
DPR14SX	DPR14S71X	D14SMSX	14	10.0
DPR16SX	DPR16S71X	D16SMSX	16	10.5
DPR20SX	DPR20S71X	D20SMSX	20	12.5
DPR25SX	DPR25S71X	D25SMSX	25	12.5
DPR30SX	DPR30S71X	D30SMSX	30	13.0
DPR38SX	DPR38S71X	D38SMSX	38	13.5

* DPR Progressive Rings in sizes 6, 8, 10 and 12mm are the same for both Series L and S.

Cutting (locking) Rings, Series LL: Zinc plated and yellow chromated (A3C)
Progressive Rings, Series L and S: Zinc plated and olive chromated (A3D)



FM

EO-2 Dual Function Nut

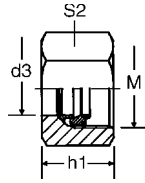

TUBE FITTING PART #	SERIES	d3 TUBE O.D. (mm)	M Metric Thread	h1 (mm)	S2 (mm)	STANDARD From Stock				
						A3C	SSA	VITA3C	VITSSA	71
FM04LL	LL	4	M8 x 1	11	10	•	•			
FM06LL	very light	6	M10 x 1	11.5	12	•	•			
FM06L	L	6	M12 x 1.5	15	14	•	•	•	•	•
FM08L	light	8	M14 x 1.5	15	17	•	•	•	•	•
FM10L		10	M16 x 1.5	16	19	•	•	•	•	•
FM12L		12	M18 x 1.5	16	22	•	•	•	•	•
FM15L		15	M22 x 1.5	17.5	27	•	•	•	•	•
FM18L		18	M26 x 1.5	18.5	32	•	•	•	•	•
FM22L		22	M30 x 2	20.5	36	•	•	•	•	•
FM28L		28	M36 x 2	21	41	•	•	•	•	•
FM35L		35	M45 x 2	24	50	•	•	•	•	•
FM42L		42	M52 x 2	24	60	•	•	•	•	•
FM06S	S	6	M14 x 1.5	17	17	•	•	•	•	•
FM08S	heavy	8	M16 x 1.5	17	19	•	•	•	•	•
FM10S		10	M18 x 1.5	18	22	•	•	•	•	•
FM12S		12	M20 x 1.5	18	24	•	•	•	•	•
FM14S		14	M22 x 1.5	21	27	•	•	•	•	•
FM16S		16	M24 x 1.5	21	30	•	•	•	•	•
FM20S		20	M30 x 2	24.5	36	•	•	•	•	•
FM25S		25	M36 x 2	27	46	•	•	•	•	•
FM30S		30	M42 x 2	29	50	•	•	•	•	•
FM38S		38	M52 x 2	32.5	60	•	•	•	•	•

FM Component Breakdown by Material

	Nut	Bite Ring	Seal Ring	Elastomer	Nut Finish
A3C	Steel	Steel	Steel	NBR	Zinc Gold
SSA	Steel	Stainless Steel	Steel	NBR	Zinc Clear
VITA3C	Steel	Steel	Steel	FPM	Zinc Gold
VITSSA	Steel	Stainless Steel	Steel	FPM	Zinc Clear
71	Stainless Steel	Stainless Steel	Stainless Steel	FPM	Passivated

GM

Bulkhead Locknut

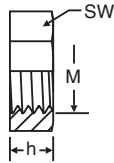

TUBE FITTING PART #	FOR USE WITH		h (mm)	M Metric Thread	SW (mm)	STANDARD From Stock		
						A3CX	71X	MSX
GM06L	6L		6	M12 x 1.5	17	•	•	•
GM08L	8L	6S	6	M14 x 1.5	19	•	•	•
GM10L	10L	8S	6	M16 x 1.5	22	•	•	•
GM12L	12L	10S	6	M18 x 1.5	24	•	•	•
GM12S		12S	6	M20 x 1.5	27	•	•	•
GM15L	15L	14S	7	M22 x 1.5	30	•	•	•
GM16S		16S	7	M24 x 1.5	32	•	•	•
GM18L	18L		8	M26 x 1.5	36	•	•	•
GM22L	22L	20S	8	M30 x 2	41	•	•	•
GM28L	28L	25S	9	M36 x 2	46	•	•	•
GM30S		30S	9	M42 x 2	50	•	•	•
GM35L	35L		9	M45 x 2	55	•	•	•
GM42L	42L	38S	10	M52 x 2	65	•	•	•

E

Tube Insert For Plastic Tube

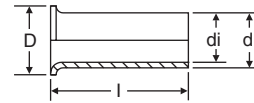

TUBE FITTING PART #	USE WITH TUBE		d (mm)	D (mm)	di (mm)	l (mm)
	O.D. Ø	I.D. Ø				
E04/02X	4	2.0	2.0	3.5	1.3	8
E04/2.5X	4	2.5	2.5	4.0	1.7	8
E0506/03X	5	3.0	3.0	5.0	2.2	14
E0506/03X	6	3.0	3.0	5.0	2.2	14
E0506/04X	5	4.0	4.0	5.0	3.2	14
E0506/04X	6	4.0	4.0	5.0	3.2	14
E08/04X	8	4.0	4.0	6.6	3.2	14
E06/05X	6	5.0	5.0	6.0	4.0	14
E08/05X	8	5.0	5.0	8.0	4.0	14
E10/05X	10	5.0	5.0	8.5	4.0	15
E0810/06X	8	6.0	6.0	8.0	5.0	15
E0810/06X	10	6.0	5.0	8.5	4.0	15
E10/08X	10	8.0	8.0	10.0	6.7	15
E12/08X	12	8.0	8.0	12.0	6.7	15
E12/09X	12	9.0	9.0	12.0	7.7	15
E1215/10X	12	10.0	10.0	12.0	8.7	15
E1215/10X	15	10.0	10.0	12.0	8.7	15
E1215/10X	16	10.0	10.0	12.0	8.7	15
E15/12X	15	12.0	12.0	14.0	10.7	15
E1516/12.5X	15	12.5	12.5	14.8	11.2	15
E1516/12.5X	16	12.5	12.5	14.8	11.2	15
E18/14X	18	14.0	14.0	17.8	12.7	15
E1820/16X	18	16.0	16.0	17.8	14.7	20
E1820/16X	20	16.0	16.0	17.8	14.7	20
E22/18X	22	18.0	18.0	21.8	16.7	15

Note: E inserts are made of brass.

VH

Tube Insert For Thin Walled Metal Tube

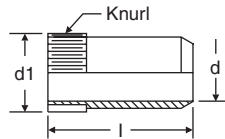

TUBE FITTING PART #	FOR TUBE I.D. Ø (mm)	d (mm)	d1 (mm)	L (mm)	STANDARD From Stock		
					A3CX	71X	MSX
VH04	4	2.6	3.8	14	•	•	•
VH04.5	4.5	3.1	4.3	14	•	•	•
VH05	5	3.6	4.8	14	•	•	•
VH06	6	4.6	5.8	14	•	•	•
VH07	7	5.6	6.8	15.5	•	•	•
VH08	8	6.6	7.8	15.5	•	•	•
VH09	9	7.6	8.8	15.5	•	•	•
VH10	10	8.6	9.8	15.5	•	•	•
VH12	12	10.2	11.8	17	•	•	•
VH13	13	11.2	12.8	17	•	•	•
VH14	14	12.2	13.8	17	•	•	•
VH15	15	13.2	14.8	20	•	•	•
VH16	16	14.2	15.8	20	•	•	•
VH17	17	15.2	16.8	20	•	•	•
VH18	18	16.2	17.8	20	•	•	•
VH19	19	17.2	18.8	16	•	•	•
VH20	20	18.2	19.8	21.5	•	•	•
VH21	21	19.2	20.8	21.5	•	•	•
VH22	22	20.2	21.8	23.5	•	•	•
VH24	24	22.2	23.8	23.5	•	•	•
VH25	25	23.2	24.8	23.5	•	•	•
VH26	26	24.2	25.8	23.5	•	•	•
VH27	27	25.2	26.8	23.5	•	•	•
VH30	30	27.8	29.8	26.5	•	•	•
VH31	31	28.8	30.8	26.5	•	•	•
VH32	32	29.8	31.8	26.5	•	•	•
VH33	33	30.8	32.8	26.5	•	•	•
VH38	38	35.8	37.8	21	•	•	•



G Full Dimensions

Union
24° Flareless / 24° Flareless

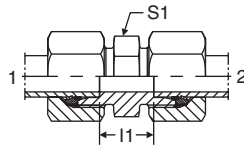

GR Full Dimensions

Union Reducer
24° Flareless / 24° Flareless

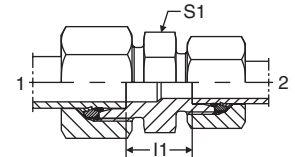

TUBE FITTING PART #	END SIZE		I 1 (mm)	S1 (mm)	STANDARD Pressure Rating (bar)				
	1 (mm)	2 (mm)			EO			EO-2	
					A3C	71	MS	A3C	71
G04LL	4	4	12	9	100	100	65	100	
G06LL	6	6	9	11	100	100	65	100	
G08LL	8	8	12	12	100	100	65		
G10LL	10	10	12	14	100		65		
G12LL	12	12	11	17	100				
G06L	6	6	10	12	315	315	205	315	315
G08L	8	8	11	14	315	315	205	315	315
G10L	10	10	13	17	315	315	205	315	315
G12L	12	12	14	19	315	315	205	315	315
G15L	15	15	16	24	315	315	205	315	315
G18L	18	18	16	27	315	315	205	315	315
G22L	22	22	20	32	160	160	104	160	160
G28L	28	28	21	41	160	160	104	160	160
G35L	35	35	20	46	160	160	104	160	160
G42L	42	42	21	55	160	160	104	160	160
G06S	6	6	16	14	630	630	410	630	630
G08S	8	8	18	17	630	630	410	630	630
G10S	10	10	17	19	630	630	410	630	630
G12S	12	12	19	22	630	630	410	630	630
G14S	14	14	22	24	630	630	410	630	630
G16S	16	16	21	27	400	400	260	400	400
G20S	20	20	23	32	400	400	260	400	400
G25S	25	25	26	41	400	400	260	400	400
G30S	30	30	27	46	400	400	260	400	400
G38S	38	38	29	55	315	315	205	315	315

For EO-2 part number, insert "Z" between size and pressure series. Example: G06ZLA3C

TUBE FITTING PART #	END SIZE		I 1 (mm)	S1 (mm)	STANDARD Pressure Rating (bar)				
	1 (mm)	2 (mm)			EO			EO-2	
					A3C	71	MS	A3C	71
GR06/04LL	6	4	10.5	11	100	100		100	
GR08/04LL	8	4	12.5	12	100				
GR08/06LL	8	6	11.0	12	100	100			
GR08/06L	8	6	11.0	14	315	315	205	315	315
GR10/06L	10	6	12.0	17	315	315	205	315	315
GR10/08L	10	8	12.0	17	315	315	205	315	315
GR12/06L	12	6	13.0	19	315	315	205	315	315
GR12/08L	12	8	13.0	19	315	315	205	315	315
GR12/10L	12	10	14.0	19	315	315	205	315	315
GR15/10L	15	10	15.0	24	315	315		315	315
GR15/12L	15	12	15.0	24	315	315		315	315
GR18/10L	18	10	15.5	27	315	315		315	315
GR18/12L	18	12	15.5	27	315	315		315	315
GR18/15L	18	15	16.5	27	315	315		315	315
GR22/12L	22	12	17.5	32	160	160		160	160
GR22/15L	22	15	18.5	32	160	160		160	160
GR22/18L	22	18	18.0	32	160	160		160	160
GR28/18L	28	18	19.0	41	160	160		160	160
GR28/22L	28	22	21.0	41	160	160		160	160
GR35/22L	35	22	21.0	46	160	160		160	160
GR35/28L	35	28	21.0	46	160	160		160	160
GR08/06S	8	6	18.0	17	630	630		630	630
GR10/06S	10	6	17.5	19	630	630		630	630
GR10/08S	10	8	17.5	19	630	630		630	630
GR12/06S	12	6	19.5	22	630	630		630	630
GR12/08S	12	8	19.5	22	630	630		630	630
GR12/10S	12	10	19.0	22	630	630		630	630
GR14/10S	14	10	20.5	24	630	630		630	630
GR14/12S	14	12	20.5	24	630	630		630	630
GR16/12S	16	12	20.0	27	400	400		400	400
GR16/14S	16	14	21.5	27	400	400		400	400
GR20/10S	20	10	22.0	32	400	400		400	400
GR20/12S	20	12	22.0	32	400	400		400	400
GR20/16S	20	16	23.0	32	400	400		400	400
GR25/16S	25	16	25.5	41	400	400		400	400
GR25/20S	25	20	25.5	41	400	400		400	400
GR30/20S	30	20	26.0	46	400	400		400	400
GR30/25S	30	25	26.5	46	400	400		400	400
GR38/30S	38	30	29.5	55	315	315		315	315

For EO-2 part number, insert "Z" between size and pressure series. Example: GR06/04ZLLA3C

How to Order

Specs

Assembly / Installation

Reference



SV Full Dimensions

Bulkhead Union
24° Flareless / 24° Flareless

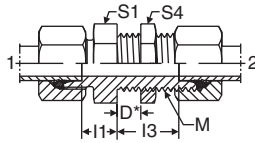

D = 16mm, max. bulkhead thickness

TUBE FITTING PART #	END SIZE		M Metric Thread	I1 (mm)	I3 (mm)	S1 (mm)	S4 (mm)	STANDARD Pressure Rating (bar)				
	1 (mm)	2 (mm)						EO			EO-2	
								A3C	71	MS	A3C	71
SV06L	6	6	M12 x 1.5	7	27.0	17	17	315	315	205	315	315
SV08L	8	8	M14 x 1.5	8	27.0	19	19	315	315	205	315	315
SV10L	10	10	M16 x 1.5	10.0	28.0	22	22	315	315	205	315	315
SV12L	12	12	M18 x 1.5	10.0	29.0	24	24	315	315	205	315	315
SV15L	15	15	M22 x 1.5	12.0	31.0	27	30	315	315	205	315	315
SV18L	18	18	M26 x 1.5	13.5	32.5	32	36	315	315	205	315	315
SV22L	22	22	M30 x 2	16.5	34.5	36	41	160	160	104	160	160
SV28L	28	28	M36 x 2	18.5	35.5	41	46	160	160	104	160	160
SV35L	35	35	M45 x 2	18.5	36.5	50	55	160	160		160	160
SV42L	42	42	M52 x 2	19.0	36.0	60	65	160	160		160	160
SV06S	6	6	M14 x 1.5	12.0	29.0	19	19	630	630	410	630	630
SV08S	8	8	M16 x 1.5	13.0	29.0	22	22	630	630	410	630	630
SV10S	10	10	M18 x 1.5	14.5	29.5	24	24	630	630	410	630	630
SV12S	12	12	M20 x 1.5	14.5	30.5	27	27	630	630	410	630	630
SV14S	14	14	M22 x 1.5	17.0	32.0	30	30	630	630		630	630
SV16S	16	16	M24 x 1.5	16.5	31.5	32	32	400	400	260	400	400
SV20S	20	20	M30 x 2	17.5	33.5	41	41	400	400	260	400	400
SV25S	25	25	M36 x 2	20.0	35.0	46	46	400	400	260	400	400
SV30S	30	30	M42 x 2	21.5	37.5	50	50	400	400	260	400	400
SV38S	38	38	M52 x 2	22.0	37.0	65	65	315	315		315	315

For EO-2 part number, insert "Z" between size and pressure series. Example: SV06ZLA3C

ESV Full Dimensions

Weld Bulkhead Fitting
24° Flareless / 24° Flareless

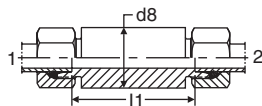

TUBE FITTING PART #	END SIZE		d8 (mm)	I1 (mm)	STANDARD Pressure Rating (bar)				
	1 (mm)	2 (mm)			EO			EO-2	
					A3C	71	MS	A3C	71
ESV06L	6	6	18	56	315	315		315	315
ESV08L	8	8	20	56	315	315		315	315
ESV10L	10	10	22	58	315	315		315	315
ESV12L	12	12	25	58	315	315		315	315
ESV15L	15	15	28	70	315	315		315	315
ESV18L	18	18	32	69	315	315		315	315
ESV22L	22	22	36	73	160	160		160	160
ESV28L	28	28	40	73	160	160		160	160
ESV35L	35	35	50	71	160	160		160	160
ESV42L	42	42	60	70	160	160		160	160
ESV06S	6	6	20	60	630	630		630	630
ESV08S	8	8	22	60	630	630		630	630
ESV10S	10	10	25	59	630	630		630	630
ESV12S	12	12	28	59	630	630		630	630
ESV14S	14	14	30	72	630	630		630	630
ESV16S	16	16	35	71	400	400		400	400
ESV20S	20	20	38	71	400	400		400	400
ESV25S	25	25	45	72	400	400		400	400
ESV30S	30	30	50	73	400	400		400	400
ESV38S	38	38	60	72	315	315		315	315

For EO-2 part number, insert "Z" between size and pressure series.

Example: ESV06ZL71

Note: Weld fitting. Omit "A3C" in the part number for steel material.



GE-UNF/UN

Full Dimensions

Male Connector
24° Flareless / SAE-ORB

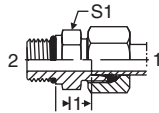

GE-NPT

Full Dimensions

Male Connector
24° Flareless / NPTF

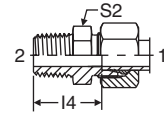

TUBE FITTING PART #	END SIZE		I1 (mm)	S1 (mm)	STANDARD Pressure Rating (bar)				
	1 (mm)	2 UN/UNF			EO			EO-2	
					A3C	71	MS	A3C	71
GE08L7/16UNF	8	7/16-20	10.0	17	315			315	
GE10L7/16UNF	10	7/16-20	11.0	17	315			315	
GE12L9/16UNF	12	9/16-18	11.0	19	315			315	
GE12L3/4UNF	12	3/4-16	13.0	24	315			315	
GE12L7/8UNF	12	7/8-14	14.3	27	315			315	
GE15L3/4UNF	15	3/4-16	14.0	24	315			315	
GE18L3/4UNF	18	3/4-16	14.5	27	315			315	
GE18L7/8UNF	18	7/8-14	14.8	27	315			315	
GE22L7/8UNF	22	7/8-14	16.8	32	160			160	
GE22L11/16UN	22	1 1/16-12	16.5	32	160			160	
GE22L15/16UN	22	1 5/16-12	17.5	41	160			160	
GE28L11/16UN	28	1 1/16-12	17.5	41	160			160	
GE28L15/16UN	28	1 5/16-12	17.5	41	160			160	
GE35L15/16UN	35	1 5/16-12	17.5	46	160			160	
GE35L15/8UN	35	1 5/8-12	17.5	50	160			160	
GE42L15/8UN	42	1 5/8-12	19.0	55	160			160	
GE08S7/16UNF	8	7/16-20	15.0	17	630			630	
GE10S9/16UNF	10	9/16-18	14.5	19	630			630	
GE12S9/16UNF	12	9/16-18	14.5	22	630			630	
GE12S3/4UNF	12	3/4-16	17.5	24	630			630	
GE16S3/4UNF	16	3/4-16	15.5	24	400			400	
GE16S7/8UNF	16	7/8-14	18.8	27	400			400	
GE20S3/4UNF	20	3/4-16	20.5	32	400			400	
GE20S7/8UNF	20	7/8-14	20.8	32	400			400	
GE20S11/16UN	20	1 1/16-12	20.5	32	400			400	
GE25S11/16UN	25	1 1/16-12	23.0	36	400			400	
GE25S15/16UN	25	1 5/16-12	23.0	41	400			400	
GE30S15/16UN	30	1 5/16-12	23.5	46	400			400	
GE30S15/8UN	30	1 5/8-12	23.5	50	400			400	
GE38S15/8UN	38	1 5/8-12	26.0	55	315			315	

For EO-2 part number, insert "Z" between size and pressure series.
Example: GE08ZL7/16UNFA3C

TUBE FITTING PART #	END SIZE		I4 (mm)	S2 (mm)	STANDARD Pressure Rating (bar)		
	1 (mm)	2 NPT			EO		
					A3C	71	MS
GE04LL1/8NPT	4	1/8-27	18.5	11	100	100	
GE06LL1/8NPT	6	1/8-27	16.5	11	100	100	65
GE08LL1/8NPT	8	1/8-27	18.5	12	100	100	65
GE06L1/8NPT	6	1/8-27	17.0	12	315	315	205
GE06L1/4NPT	6	1/4-18	23.0	17	315	315	205
GE08L1/4NPT	8	1/4-18	23.0	17	315	315	205
GE10L1/4NPT	10	1/4-18	24.0	17	315	315	205
GE10L3/8NPT	10	3/8-18	25.0	19	315	315	
GE12L1/4NPT	12	1/4-18	25.0	19	315	315	205
GE12L3/8NPT	12	3/8-18	25.0	19	315	315	205
GE12L1/2NPT	12	1/2-14	30.0	22	315	315	205
GE15L1/2NPT	15	1/2-14	31.0	24	315	315	205
GE18L1/2NPT	18	1/2-14	31.5	27	315	315	205
GE22L3/4NPT	22	3/4-14	33.5	32	160	160	104
GE28L1NPT	28	1-11 1/2	39.5	41	160	160	104
GE35L11/4NPT	35	1 1/4-11 1/2	40.5	46	160	160	
GE42L11/2NPT	42	1 1/2-11 1/2	42.0	55	160	160	
GE06S1/4NPT	6	1/4-18	28.0	17	630	630	410
GE08S1/4NPT	8	1/4-18	28.0	17	630	630	410
GE10S1/4NPT	10	1/4-18	27.5	19	630	630	
GE10S3/8NPT	10	3/8-18	27.5	19	630	630	
GE12S1/4NPT	12	1/4-18	29.5	22	630	630	
GE12S3/8NPT	12	3/8-18	29.5	22	630	630	410
GE12S1/2NPT	12	1/2-14	34.5	22	630	630	410
GE14S1/2NPT	14	1/2-14	36.0	24	630	630	410
GE16S1/2NPT	16	1/2-14	35.5	27	400	400	260
GE20S3/4NPT	20	3/4-14	37.5	32	400	400	260
GE25S1NPT	25	1-11 1/2	45.0	41	400	400	
GE30S11/4NPT	30	1 1/4-11 1/2	46.5	46	400	400	
GE38S11/2NPT	38	1 1/2-11 1/2	49.0	55	315	315	



GEO Full Dimensions

Male Connector
24° Flareless / ISO 6149

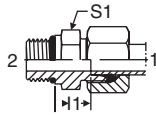

GE-R-ED Full Dimensions

Male Connector
24° Flareless / BSPP

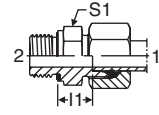

DIN 3852-2 Form E



TUBE FITTING PART #	END SIZE		I 1 (mm)	S1 (mm)	STANDARD Pressure Rating (bar)				
	1 (mm)	2 Metric Thread			EO			EO-2	
					A3C	71	MS	A3C	71
GEO04LLM	4	M8 x 1	9.5	11	100			100	
GEO04LLM10x1	4	M10 x 1	9.5	13	100			100	
GEO06LLM	6	M10 x 1	8.0	13					
GEO06LM	6	M10 x 1	8.5	14	315			315	
GEO08LM	8	M12 x 1.5	10.0	17	315			315	
GEO10LM	10	M14 x 1.5	11.0	19	315			315	
GEO12LM	12	M16 x 1.5	12.5	22	315			315	
GEO15LM	15	M18 x 1.5	13.5	24	315			315	
GEO18LM	18	M22 x 1.5	14.5	27	315			315	
GEO22LM27x2	22	M27 x 2	16.5	32	160			160	
GEO28LM	28	M33 x 2	17.5	41	160			160	
GEO35LM	35	M42 x 2	17.5	50	160			160	
GEO42LM	42	M48 x 2	19.0	55	160			160	
GEO06SM	6	M12 x 1.5	13.0	17	630			630	
GEO08SM	8	M14 x 1.5	15.0	19	630			630	
GEO10SM	10	M16 x 1.5	15.0	22	630			630	
GEO12SM	12	M18 x 1.5	17.0	24	630			630	
GEO16SM	16	M22 x 1.5	18.5	27	400			400	
GEO20SM	20	M27 x 2	20.5	32	400			400	
GEO25SM	25	M33 x 2	23.0	41	400			400	
GEO30SM	30	M42 x 2	23.5	50	400			400	
GEO38SM	38	M48 x 2	26.0	55	315			315	

For EO-2 part number, insert "Z" between size and pressure series.
Example: GEO06ZLMA3C

TUBE FITTING PART #	END SIZE		I 1 (mm)	S1 (mm)	STANDARD Pressure Rating (bar)				
	1 (mm)	2 BSPP			EO			EO-2	
					A3C	71	MS	A3C	71
GE04LLRED	4	G 1/8 A	9.5	14	100			100	
GE06LLRED	6	G 1/8 A	8.0	14	100			100	
GE06LRED	6	G 1/8 A	8.5	14	315	315		315	315
GE06LR1/4ED	6	G 1/4 A	10.0	19	315	315		315	315
GE08LR1/8ED	8	G 1/8 A	9.5	14	315	315		315	315
GE08LRED	8	G 1/4 A	10.0	19	315	315		315	315
GE08LR3/8ED	8	G 3/8 A	11.5	22	315	315		315	315
GE10LRED	10	G 1/4 A	11.0	19	315	315		315	315
GE10LR3/8ED	10	G 3/8 A	12.5	22	315	315		315	315
GE10LR1/2ED	10	G 1/2 A	13.0	27	315	315		315	315
GE12LR1/4ED	12	G 1/4 A	12.0	19	315	315		315	315
GE12LRED	12	G 3/8 A	12.5	22	315	315		315	315
GE12LR1/2ED	12	G 1/2 A	13.0	27	315	315		315	315
GE15LR3/8ED	15	G 3/8 A	13.5	24	315	315		315	315
GE15LRED	15	G 1/2 A	14.0	27	315	315		315	315
GE18LRED	18	G 1/2 A	14.5	27	315	315		315	315
GE18LR3/4ED	18	G 3/4 A	14.5	32	315	315		315	315
GE22LRED	22	G 3/4 A	16.5	32	160	160		160	160
GE28LRED	28	G 1 A	17.5	41	160	160		160	160
GE35LRED	35	G 1 1/4 A	17.5	50	160	160		160	160
GE42LRED	42	G 1 1/2 A	19.0	55	160	160		160	160
GE06SRED	6	G 1/4 A	13.0	19	630	630		630	630
GE08SRED	8	G 1/4 A	15.0	19	630	630		630	630
GE08SR3/8ED	8	G 3/8 A	15.5	22	630	630		630	630
GE10SR1/4ED	10	G 1/4 A	14.5	19	630	630		630	630
GE10SRED	10	G 3/8 A	15.0	22	630	630		630	630
GE10SR1/2ED	10	G 1/2 A	17.5	27	630	630		630	630
GE12SR1/4ED	12	G 1/4 A	16.5	22	630	630		630	630
GE12SRED	12	G 3/8 A	17.0	22	630	630		630	630
GE12SR1/2ED	12	G 1/2 A	17.5	27	630	630		630	630
GE14SRED	14	G 1/2 A	19.0	27	630	630		630	630
GE16SR3/8ED	16	G 3/8 A	18.0	27	400	400		400	400
GE16SRED	16	G 1/2 A	18.5	27	400	400		400	400
GE16SR3/4ED	16	G 3/4 A	20.5	32	400	400		400	400
GE20SRED	20	G 3/4 A	20.5	32	400	400		400	400
GE25SR1/2ED	25	G 1/2 A	23.0	41	400			400	
GE25SRED	25	G 1 A	23.0	41	400	400		400	400
GE30SRED	30	G 1 1/4 A	23.5	50	400	400		400	400
GE38SRED	38	G 1 1/2 A	26.0	55	315	315		315	315

For EO-2 part number, insert "Z" between size and pressure series.
Example: GE06ZLREDA3C

GE-R Full Dimensions

Male Connector
24° Flareless / BSPT or BSPP

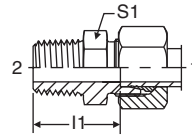

R (BSPT) thread

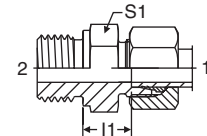

Cutting face DIN 3852, form B,
G (BSPP) thread



TUBE FITTING PART #	END SIZE		I1 (mm)	S1 (mm)	STANDARD Pressure Rating (bar)		
	1 (mm)	2 BSPT / BSPP			EO		
					A3C	71	MS
GE04LLR	4	R 1/8 keg.	16.0	11	100	100	65
GE06LLR	6	R 1/8 keg.	14.5	11	100	100	65
GE08LLR	8	R 1/8 keg.	16.5	12	100	100	65
GE08LLR1/4	8	R 1/4 keg.	20.5	14	100		65
GE10LLR	10	R 1/4 keg.	20.5	14	100		65
GE12LLR	12	R 1/4 keg.	20.0	17	100		65
GE12LLR3/8	12	R 3/8 keg.	20.0	17	100		
GE06LR	6	G 1/8 A	8.5	14	315	315	205
GE06LR1/8KEG	6	R 1/8 keg.	15.0	12	315		
GE06LR1/4	6	G 1/4 A	10.0	19	315	315	205
GE06LR3/8	6	G 3/8 A	11.5	22	315	315	205
GE06LR1/2	6	G 1/2 A	12.0	27	315	315	
GE08LR	8	G 1/4 A	10.0	19	315	315	205
GE08LR1/8	8	G 1/8 A	8.5	14	315	315	
GE08LR1/4KEG	8	R 1/4 keg.	20.0	17	315		
GE08LR3/8	8	G 3/8 A	11.5	22	315	315	205
GE08LR1/2	8	G 1/2 A	12.0	27	315	315	205
GE10LR	10	G 1/4 A	11.0	19	315	315	205
GE10LR1/4KEG	10	R 1/4 keg.	21.0	17	315		
GE10LR3/8	10	G 3/8 A	12.5	22	315	315	205
GE10LR1/2	10	G 1/2 A	13.0	27	315	315	205
GE12LR	12	G 3/8 A	12.5	22	315	315	205
GE12LR1/4	12	G 1/4 A	12.0	19	315	315	205
GE12LR1/4KEG	12	R 1/4 keg.	22.0	19	315		
GE12LR3/8KEG	12	R 3/8 keg.	22.0	19	315		
GE12LR1/2	12	G 1/2 A	13.0	27	315	315	205
GE12LR1/2KEG	12	R 1/2 keg.	24.0	24	315		
GE12LR3/4	12	G 3/4 A	14.0	32	315		
GE15LR	15	G 1/2 A	14.0	27	250	250	163
GE15LR3/8	15	G 3/8 A	13.5	24	250	250	163
GE15LR3/8KEG	15	R 3/8 keg.	23.0	24	250		
GE15LR1/2KEG	15	R 1/2 keg.	25.0	24	250		
GE15LR3/4	15	G 3/4 A	15.0	32	250	250	
GE18LR	18	G 1/2 A	14.5	27	250	250	163
GE18LR3/8	18	G 3/8 A	14.0	27	250	250	
GE18LR1/2KEG	18	R 1/2 keg.	25.5	27	250		
GE18LR3/4	18	G 3/4 A	14.5	32	250	250	
GE22LR	22	G 3/4 A	16.5	32	160	160	104
GE22LR1/2	22	G 1/2 A	16.5	32	160	160	104
GE22LR3/4KEG	22	R 3/4 keg.	29.5	32	160		
GE28LR	28	G 1 A	17.5	41	160	160	104
GE28LR3/4	28	G 3/4 A	17.5	41	160	160	
GE35LR	35	G 1 1/4 A	17.5	50	160	160	104
GE35LR1	35	G 1 A	17.5	46	160	160	
GE42LR	42	G 1 1/2 A	19.0	55	160	160	104

TUBE FITTING PART #	END SIZE		I1 (mm)	S1 (mm)	STANDARD Pressure Rating (bar)		
	1 (mm)	2 BSPT / BSPP			EO		
					A3C	71	MS
GE06SR	6	G 1/4 A	13.0	19	400	400	260
GE06SR1/2	6	G 1/2 A	18.0	27	400	400	
GE08SR	8	G 1/4 A	15.0	19	400	400	260
GE08SR3/8	8	G 3/8 A	15.5	22	400	400	
GE10SR	10	G 3/8 A	15.0	22	400	400	260
GE10SR1/4	10	G 1/4 A	14.5	19	400	400	
GE10SR1/2	10	G 1/2 A	17.5	27	400	400	
GE12SR	12	G 3/8 A	17.0	22	400	400	260
GE12SR1/4	12	G 1/4 A	16.5	22	400	400	
GE12SR1/2	12	G 1/2 A	17.5	27	400	400	
GE14SR	14	G 1/2 A	19.0	27	400	400	260
GE14SR3/8	14	G 3/8 A	18.5	24	400	400	
GE16SR	16	G 1/2 A	18.5	27	250	250	163
GE16SR3/8	16	G 3/8 A	18.0	27	250	250	
GE16SR3/4	16	G 3/4 A	20.5	32	250		
GE20SR	20	G 3/4 A	20.5	32	250	250	163
GE20SR1/2	20	G 1/2 A	20.5	32	250	250	
GE25SR	25	G 1 A	23.0	41	250	250	163
GE25SR3/4	25	G 3/4 A	23.0	41	250	250	
GE30SR	30	G 1 1/4 A	23.5	50	160	160	104
GE30SR1	30	G 1 A	23.5	46	160	160	
GE38SR	38	G 1 1/2 A	26.0	55	160	160	104
GE38SR11/4	38	G 1 1/4 A	26.0	55	160	160	

Note: "keg." refers to tapered threads.



GE-M-ED Full Dimensions

Male Connector
24° Flareless / Metric with
EOlastic Seal

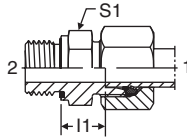

DIN 3852-1, form E

How to Order

Specs

Assembly / Installation

Reference

TUBE FITTING PART #	END SIZE		I 1 (mm)	S1 (mm)	STANDARD Pressure Rating (bar)				
	1 (mm)	2 Metric			EO		EO-2		
					A3C	71	A3C	71	
GE06LMED	6	M10 x 1	8.5	14	315	315		315	315
GE08LMED	8	M12 x 1.5	10.0	17	315	315		315	315
GE10LMED	10	M14 x 1.5	11.0	19	315	315		315	315
GE12LMED	12	M16 x 1.5	12.5	22	315	315		315	315
GE12LM18x1.5ED	12	M18 x 1.5	12.5	24	315			315	
GE12LM22x1.5ED	12	M22 x 1.5	14.0	27	315			315	
GE15LMED	15	M18 x 1.5	13.5	24	315	315		315	
GE15LM22x1.5ED	15	M22 x 1.5	15.0	27	315			315	
GE18LMED	18	M22 x 1.5	14.5	27	315	315		315	315
GE22LMED	22	M26 x 1.5	16.5	32	160	160		160	160
GE28LMED	28	M33 x 2	17.5	41	160	160		160	160
GE35LMED	35	M42 x 2	17.5	50	160	160		160	160
GE42LMED	42	M48 x 2	19.0	55	160	160		160	160
GE06SMED	6	M12 x 1.5	13.0	17	630	630		630	630
GE08SMED	8	M14 x 1.5	15.0	19	630	630		630	630
GE10SMED	10	M16 x 1.5	15.0	22	630	630		630	630
GE12SMED	12	M18 x 1.5	17.0	24	630	630		630	630
GE14SMED	14	M20 x 1.5	19.0	27	630	630		630	630
GE16SMED	16	M22 x 1.5	18.5	27	400	400		400	400
GE20SMED	20	M27 x 2	20.5	32	400	400		400	400
GE25SMED	25	M33 x 2	23.0	41	400	400		400	400
GE30SMED	30	M42 x 2	23.5	50	400	400		400	400
GE38SMED	38	M48 x 2	26.0	55	315	315		315	315

For EO-2 part number, insert "Z" between size and pressure series.
Example: GE06ZLMEDA3C

GE-M Full Dimensions

Male Connector
24° Flareless / Metric

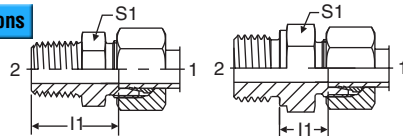

Metric taper thread

Cutting face DIN 3852, form B, Metric thread

GAI-R Full Dimensions

Female Connector
24° Flareless / BSPP

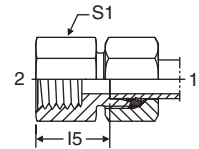

TUBE FITTING PART #	END SIZE		I1 (mm)	S1 (mm)	STANDARD Pressure Rating (bar)		
	1 (mm)	2 Metric			EO		
					A3C	71	MS
GE04LLM6X1KEG	4	M6 x 1 keg.	16.0	9	100		
GE04LLM	4	M8 x 1 keg.	16.0	10	100	100	65
GE06LLM	6	M10 x 1 keg.	14.5	11	100	100	65
GE08LLM	8	M10 x 1 keg.	16.5	12	100	100	65
GE06LM	6	M10 x 1	8.5	14	315	315	205
GE08LM	8	M12 x 1.5	10.0	17	315	315	205
GE10LM	10	M14 x 1.5	11.0	19	315	315	205
GE10LM16X1.5	10	M16 x 1.5	12.0	22	315	315	
GE10LM18X1.5	10	M18 x 1.5	12.5	24	315		
GE10LM22X1.5	10	M22 x 1.5	14.0	27	315		
GE12LM14X1.5	12	M14 x 1.5	11.0	19	315		
GE12LM	12	M16 x 1.5	12.5	22	315	315	205
GE12LM18X1.5	12	M18 x 1.5	12.5	24	315		
GE12LM22X1.5	12	M22 x 1.5	14.0	27	315		
GE15LM16X1.5	15	M16 x 1.5	13.0	24	250		
GE15LM	15	M18 x 1.5	13.5	24	250	250	
GE15LM22X1.5	15	M22 x 1.5	15.0	27	250		
GE18LM18X1.5	18	M18 x 1.5	14.0	27	250		
GE18LM	18	M22 x 1.5	14.5	27	250	250	163
GE22LM22X1.5	22	M22 x 1.5	16.5	32	160		
GE22LM	22	M26 x 1.5	16.5	32	160	160	104
GE28LM	28	M33 x 2	17.5	41	160	160	
GE35LM	35	M42 x 2	17.5	50	160	160	
GE42LM	42	M48 x 2	19.0	55	160		
GE06SM	6	M12 x 1.5	13.0	17	400	400	
GE08SM	8	M14 x 1.5	15.0	19	400	400	
GE10SM	10	M16 x 1.5	15.0	22	400	400	
GE12SM	12	M18 x 1.5	17.0	24	400	400	
GE12SM22X1.5	12	M22 x 1.5	17.5	27	400		
GE14SM	14	M20 x 1.5	19.0	27	400	400	
GE16SM18X1.5	16	M18 x 1.5	18.0	27	400		
GE16SM	16	M22 x 1.5	18.5	27	400	400	
GE20SM	20	M27 x 2	20.5	32	400	400	
GE25SM	25	M33 x 2	23.0	41	250	250	
GE30SM	30	M42 x 2	23.5	50	160	160	
GE38SM	38	M48 x 2	26.0	55	160	160	

Note: "keg." refers to taper threads.

TUBE FITTING PART #	END SIZE		I5 (mm)	S1 (mm)	STANDARD Pressure Rating (bar)				
	1 (mm)	2 BSPP			EO		EO-2		
					A3C	71	MS	A3C	71
GAI06LR	6	G 1/8	19.0	14	315	315	205	315	315
GAI08LR	8	G 1/4	24.0	19	315	315	205	315	315
GAI08LR3/8	8	G 3/8	25.0	24	315			315	
GAI08LR1/2	8	G 1/2	29.0	27	315			315	
GAI10LR	10	G 1/4	25.0	19	315	315	205	315	315
GAI10LR3/8	10	G 3/8	26.0	24	315			315	
GAI10LR1/2	10	G 1/2	30.0	27	315			315	
GAI12LR	12	G 3/8	26.0	24	315	315	205	315	
GAI12LR1/2	12	G 1/2	30.0	27	315	315		315	315
GAI15LR	15	G 1/2	31.0	27	315	315	205	315	315
GAI18LR	18	G 1/2	30.5	27	315	315	205	315	315
GAI22LR	22	G 3/4	35.5	36	160	160	104	160	160
GAI28LR	28	G 1	38.0	41	160	160		160	160
GAI35LR	35	G 1 1/4	41.0	55	160	160		160	160
GAI42LR	42	G 1 1/2	42.5	60	160	160		160	160
GAI06SR	6	G 1/4	26.0	19	400	400		400	400
GAI08SR	8	G 1/4	26.0	19	400	400		400	400
GAI10SR	10	G 3/8	26.5	24	400	400	260	400	400
GAI12SR	12	G 3/8	26.5	24	400	400		400	400
GAI14SR	14	G 1/2	32.0	30	400	400		400	400
GAI16SR	16	G 1/2	31.5	30	400	400		400	400
GAI20SR	20	G 3/4	34.5	36	315	315		315	315
GAI25SR	25	G 1	37.5	41	315	315		315	315
GAI30SR	30	G 1 1/4	42.0	55	315	315		315	315
GAI38SR	38	G 1 1/2	43.5	60	250	250		250	250

For EO-2 part number, insert "Z" between size and pressure series.
Example: GAI06ZLRA3C

GAI-M Full Dimensions

Female Connector
24° Flareless / Metric

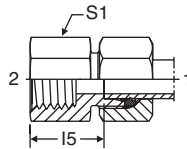

AS Full Dimensions

Weld Connector
24° Flareless / Butt Weld

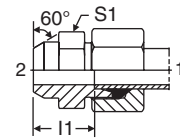

TUBE FITTING PART #	END SIZE		I 5 (mm)	S1 (mm)	STANDARD Pressure Rating (bar)				
	1 (mm)	2 Metric			EO			EO-2	
					A3C	71	MS	A3C	71
GAI06LM	6	M10 x 1	19.5	14	315	315		315	315
GAI08LM	8	M12 x 1.5	24.0	17	315	315		315	315
GAI10LM	10	M14 x 1.5	25.0	19	315	315		315	315
GAI12LM	12	M16 x 1.5	26.0	22	315	315		315	315
GAI15LM	15	M18 x 1.5	28.0	24	315	315		315	315
GAI18LM	18	M22 x 1.5	29.5	30	315	315		315	315
GAI22LM	22	M26 x 1.5	34.5	32	160	160		160	160
GAI28LM	28	M33 x 2	37.5	41		160			160
GAI35LM	35	M42 x 2	40.5	55		160			160
GAI42LM	42	M48 x 2	42.0	60		160			160
GAI06SM	6	M12 x 1.5	26.0	17	400	400		400	400
GAI08SM	8	M14 x 1.5	26.0	17	400	400		400	400
GAI10SM	10	M16 x 1.5	26.5	22	400	400		400	400
GAI12SM	12	M18 x 1.5	27.5	24	400	400		400	400
GAI14SM	14	M20 x 1.5	31.0	27	400	400		400	400
GAI16SM	16	M22 x 1.5	30.5	30	400	400		400	400
GAI20SM	20	M27 x 2	34.5	36	315	315		315	315
GAI25SM	25	M33 x 2	37.0	41		315			315
GAI30SM	30	M42 x 2	41.5	55		315			315
GAI38SM	38	M48 x 2	43.0	60		250			250

For EO-2 part number, insert "Z" between size and pressure series.
Example: GAI06ZLMA3C

TUBE FITTING PART #	END SIZE		I 1 (mm)	S1 (mm)	STANDARD Pressure Rating (bar)				
	1 (mm)	2 (mm)			EO			EO-2	
					A3C	71	MS	A3C	71
AS06L	6	10	14.0	12	315	315		315	315
AS08L	8	12	16.0	14	315	315		315	315
AS10L	10	14	18.0	17	315	315		315	315
AS12L	12	16	18.0	19	315	315		315	315
AS15L	15	19	22.0	22	315	315		315	315
AS18L	18	22	23.5	27	315	315		315	315
AS22L	22	27	28.5	32	160	160		160	160
AS28L	28	32	30.5	41	160	160		160	160
AS35L	35	40	32.5	46	160	160		160	160
AS42L	42	46	35.0	55	160	160		160	160
AS06S	6	11	19.0	14	630	630		630	630
AS08S	8	13	21.0	17	630	630		630	630
AS10S	10	15	22.5	19	630	630		630	630
AS12S	12	17	24.5	22	630	630		630	630
AS14S	14	19	27.0	24	630	630		630	630
AS16S	16	21	26.5	27	400	400		400	400
AS20S	20	26	29.5	32	400	400		400	400
AS25S	25	31	32.0	41	400	400		400	400
AS30S	30	36	35.5	46	400	400		400	400
AS38S	38	44	38.0	55	315	315		315	315

Note: Weld fitting. Omit "A3C" in the part number for steel material.
For EO-2 part number, insert "Z" between size and pressure series.
Example: AS06ZL

RED Full Dimensions

Tube End Reducer
Flareless Swivel / 24° Flareless

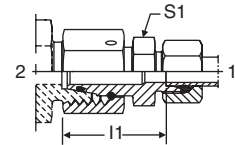

- [How to Order](#)
- [Specs](#)
- [Assembly / Installation](#)
- [Reference](#)

L-Series

TUBE FITTING PART #	END SIZE		I1 (mm)	S1 (mm)	STANDARD Pressure Rating (bar)				
	1 (mm)	2 Metric			EO			EO-2	
					A3C	71	MS	A3C	71
RED06L/04LL	4	M12 x 1.5	24.5	9				250	
RED08/06L	6	M14 x 1.5	23.5	12	315	315		315	315
RED10/06L	6	M16 x 1.5	25	14	315	315		315	315
RED10/08L	8		25		315	315		315	315
RED12/06L	6	M18 x 1.5	25	17	315	315		315	315
RED12/08L	8		25		315	315		315	315
RED12/10L	10		26		315	315		315	315
RED15/06L	6	M22 x 1.5	28.5	19	315	315		315	315
RED15/08L	8		28.5		315	315		315	315
RED15/10L	10		29.5		315	315		315	315
RED15/12L	12		29.5		315	315		315	315
RED18/06L	6	M26 x 1.5	28	24	315	315		315	315
RED18/08L	8		28		315	315		315	315
RED18/10L	10		29		315	315		315	315
RED18/12L	12		29		315	315		315	315
RED18/15L	15		30		315	315		315	315
RED22/06L	6	M30 x 2	32	27	160	160		160	160
RED22/08L	8		32		160	160		160	160
RED22/10L	10		33		160	160		160	160
RED22/12L	12		33		160	160		160	160
RED22/15L	15		34		160	160		160	160
RED22/18L	18		33.5		160	160		160	160
RED28/06L	6	M36 x 2	34	32	160			160	
RED28/08L	8		34		160			160	
RED28/10L	10		35		160	160		160	160
RED28/12L	12		35		160	160		160	160
RED28/15L	15		36		160	160		160	160
RED28/18L	18		35.5		160	160		160	160
RED28/22L	22		37.5		160	160		160	160
RED35/12L	12	M45 x 2	38	41	160			160	
RED35/15L	15		39		160	160		160	160
RED35/18L	18		38.5		160	160		160	160
RED35/22L	22		40.5		160	160		160	160
RED35/28L	28		40.5		160	160		160	160
RED42/18L	18	M52 x 2	42	50	160			160	
RED42/22L	22		44		160	160		160	160
RED42/28L	28		44		160	160		160	160
RED42/35L	35		43		160	160		160	160

For EO-2 part number, insert "Z" between size and pressure series.
Example: RED08/06ZLA3C

S-Series

TUBE FITTING PART #	END SIZE		I1 (mm)	S1 (mm)	STANDARD Pressure Rating (bar)				
	1 (mm)	2 Metric			EO			EO-2	
					A3C	71	MS	A3C	71
RED08/06S	6	M16 x 1.5	27	14	630	630		630	630
RED10/06S	6	M18 x 1.5	27.5	17	630	630		630	630
RED10/08S	8		27.5		630	630		630	630
RED12/06S	6	M20 x 1.5	29	17	630	630		630	630
RED12/08S	8		29	17	630	630		630	630
RED12/10S	10		29.5	19	630	630		630	630
RED14/06S	6	M22 x 1.5	31.5	19	630			630	
RED14/08S	8		31.5	19	630			630	
RED14/10S	10		31	19	630	630		630	630
RED14/12S	12		31	22	630	630		630	630
RED16/06S	6	M24 x 1.5	32	22	400	400		400	400
RED16/08S	8		32	22	400	400		400	400
RED16/10S	10		31.5	22	400	400		400	400
RED16/12S	12		31.5	22	400	400		400	400
RED16/14S	14		33	24	400	400		400	400
RED20/06S	6	M30 x 2	36	27	400	400		400	400
RED20/08S	8		36		400	400		400	400
RED20/10S	10		35.5		400	400		400	400
RED20/12S	12		35.5		400	400		400	400
RED20/14S	14		37		400	400		400	400
RED20/16S	16		36.5		400	400		400	400
RED25/06S	6	M36 x 2	38.5	32	400			400	
RED25/08S	8		38.5		400			400	
RED25/10S	10		38		400	400		400	400
RED25/12S	12		38		400	400		400	400
RED25/14S	14		39.5		400	400		400	400
RED25/16S	16		39		400	400		400	400
RED25/20S	20		39		400	400		400	400
RED30/08S	8	M42 x 2	44	41					
RED30/10S	10		43.5		400	400		400	400
RED30/12S	12		43.5		400	400		400	400
RED30/14S	14		45			400			400
RED30/16S	16		44.5		400	400		400	400
RED30/20S	20		44.5		400	400		400	400
RED30/25S	25		45		400	400		400	400
RED38/12S	12	M52 x 2	47	50	315			315	
RED38/16S	16		48		315	315		315	315
RED38/20S	20		48		315	315		315	315
RED38/25S	25		48.5		315	315		315	315
RED38/30S	30		49		315	315		315	315

For EO-2 part number, insert "Z" between size and pressure series.
Example: RED08/06ZS

DA Full Dimensions

Distance Piece Adapter
Flareless Swivel / 24° Flareless

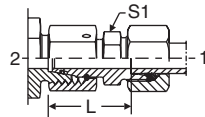

TUBE FITTING PART #	END SIZE		L (mm)	S1 (mm)	STANDARD Pressure Rating (bar)				
	1 (mm)	2 Metric			EO		EO-2		
					A3C	71	MS	A3C	71
DA06L	6	M12 x 1.5	36	12	315			315	
DA08L	8	M14 x 1.5	36	14	315			315	
DA10L	10	M16 x 1.5	36	17	315			315	
DA12L	12	M18 x 1.5	36	19	315			315	
DA15L	15	M22 x 1.5	36	24	315			315	
DA18L	18	M26 x 1.5	36	27	315			315	
DA22L	22	M30 x 2	40	32	160			160	
DA28L	28	M36 x 2	40	41	160			160	
DA35L	35	M45 x 2	50	46	160			160	
DA42L	42	M52 x 2	60	55	160			160	
DA06S	6	M14 x 1.5	36	12	630			630	
DA08S	8	M16 x 1.5	36	14	630			630	
DA10S	10	M18 x 1.5	36	17	630			630	
DA12S	12	M20 x 1.5	36	19	630			630	
DA14S	14	M22 x 1.5	40	24	630			630	
DA16S	16	M24 x 1.5	40	27	400			400	
DA20S	20	M30 x 2	46	32	400			400	
DA25S	25	M36 x 2	50	41	400			400	
DA30S	30	M42 x 2	56	46	400			400	
DA38S	38	M52 x 2	60	55	315			315	

For EO-2 part number, insert "Z" between size and pressure series.
Example: DA06ZLA3C

GZ Full Dimensions

Swivel Union
Flareless Swivel / Flareless Swivel

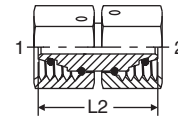

TUBE FITTING PART #	END SIZE		L2 (mm)	STANDARD Pressure Rating (bar)		
	1 & 2 Metric	EO				
		A3C		71	MS	
GZ06L	M12 x 1.5	32	315	315		
GZ08L	M14 x 1.5	32	315	315		
GZ10L	M16 x 1.5	33	315	315		
GZ12L	M18 x 1.5	33	315	315		
GZ15L	M22 x 1.5	38	315	315		
GZ18L	M26 x 1.5	36	315	315		
GZ22L	M30 x 2	42	160	160		
GZ28L	M36 x 2	46	160	160		
GZ35L	M45 x 2	48	160	160		
GZ42L	M52 x 2	52	160	160		
GZ06S	M14 x 1.5	32	630	630		
GZ08S	M16 x 1.5	33	630	630		
GZ10S	M18 x 1.5	33	630	630		
GZ12S	M20 x 1.5	36	630	630		
GZ14S	M22 x 1.5	39	630	630		
GZ16S	M24 x 1.5	39	400	400		
GZ20S	M30 x 2	44	400	400		
GZ25S	M36 x 2	46	400	400		
GZ30S	M42 x 2	52	400	400		
GZ38S	M52 x 2	52	315	315		



GZR Full Dimensions

Swivel Union Reducer
Flareless Swivel / Flareless Swivel

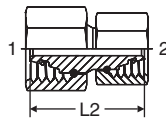

TUBE FITTING PART #	END SIZE		L2 (mm)	S1 (mm)	STANDARD Pressure Rating (bar)		
	1 Metric	2 Metric			EO		
					A3C	71	MS
GZR06L/06S	M14 x 1.5	M12 x 1.5	32	315			
GZR08L/08S	M16 x 1.5	M14 x 1.5	33	315			
GZR10L/10S	M18 x 1.5	M16 x 1.5	33	315			
GZR12L/12S	M20 x 1.5	M18 x 1.5	36	315			
GZR18L/16S	M26 x 1.5	M24 x 1.5	39	315			
GZR22L/20S	M30 x 2	M30 x 2	44	160			
GZR28L/25S	M36 x 2	M36 x 2	46	160			
GZR35L/30S	M45 x 2	M42 x 2	52	160			
GZR42L/38S	M52 x 2	M52 x 2	52	160			
GZR16S/15L	M24 x 1.5	M22 x 1.5	39	315			
GZR20S/18L	M30 x 2	M26 x 1.5	44	315			
GZR25S/22L	M36 x 2	M30 x 2	46	160			
GZR30S/28L	M42 x 2	M36 x 2	52	160			
GZR38S/35L	M52 x 2	M45 x 2	52	160			

EGE-NPT Full Dimensions

Swivel Connector
Flareless Swivel / NPT

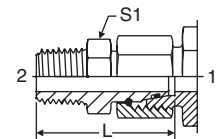

TUBE FITTING PART #	END SIZE		L (mm)	S1 (mm)	STANDARD Pressure Rating (bar)		
	1 Metric	2 NPT			EO		
					A3C	71	MS
EGE06L1/8NPT	M12 x 1.5	1/8-27	31.5	11	315		
EGE08L1/4NPT	M14 x 1.5	1/4-18	37.5	14	315		
EGE10L1/4NPT	M16 x 1.5	1/4-18	38.0	14	315		
EGE12L3/8NPT	M18 x 1.5	3/8-18	40.0	19	315		
EGE15L1/2NPT	M22 x 1.5	1/2-14	49.5	22	315		
EGE18L1/2NPT	M26 x 1.5	1/2-14	49.0	24	315		
EGE22L3/4NPT	M30 x 2	3/4-14	52.0	27	160		
EGE28L1NPT	M36 x 2	1-11 1/2	61.0	36	160		
EGE35L11/4NPT	M45 x 2	1 1/4-11 1/2	65.5	46	160		
EGE42L11/2NPT	M52 x 2	1 1/2-11 1/2	68.5	50	160		
EGE06S1/4NPT	M14 x 1.5	1/4-18	37.5	14	630		
EGE08S1/4NPT	M16 x 1.5	1/4-18	38.0	14	630		
EGE10S3/8NPT	M18 x 1.5	3/8-18	40.5	19	630		
EGE12S3/8NPT	M20 x 1.5	3/8-18	42.0	19	630		
EGE14S1/2NPT	M22 x 1.5	1/2-14	50.5	22	630		
EGE16S1/2NPT	M24 x 1.5	1/2-14	51.0	22	400		
EGE20S3/4NPT	M30 x 2	3/4-14	54.0	27	400		
EGE25S1NPT	M36 x 2	1-11 1/2	63.5	36	400		
EGE30S11/4NPT	M42 x 2	1 1/4-11 1/2	70.5	46	400		
EGE38S11/2NPT	M52 x 2	1 1/2-11 1/2	73.5	50	315		



EGEO

Swivel Connector
Metric ISO 6149 / Flareless Swivel

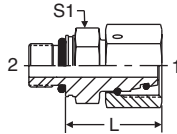

TUBE FITTING PART #	END SIZE		L (mm)	S1 (mm)	STANDARD Pressure Rating (bar)		
	1 Metric	2 Metric			EO		
	A3C	71			MS		
EGEO06LM	M12 x 1.5	M10 x 1	24.5	14	315		
EGEO08LM	M14 x 1.5	M12 x 1.5	26.5	17	315		
EGEO10LM	M16 x 1.5	M14 x 1.5	27.5	19	315		
EGEO12LM	M18 x 1.5	M16 x 1.5	30.5	22	315		
EGEO15LM	M22 x 1.5	M18 x 1.5	31.5	24	315		
EGEO18LM	M26 x 1.5	M22 x 1.5	31.5	27	315		
EGEO22LM27X2	M30 x 2	M27 x 2	32.5	32	160		
EGEO28LM	M36 x 2	M33 x 2	35.0	41	160		
EGEO35LM	M45 x 2	M42 x 2	42.5	50	160		
EGEO08SM	M16 x 1.5	M14 x 1.5	29.5	19	630		
EGEO10SM	M18 x 1.5	M16 x 1.5	32.0	22	630		
EGEO12SM	M20 x 1.5	M18 x 1.5	34.0	24	630		
EGEO16SM	M24 x 1.5	M22 x 1.5	37.0	27	400		
EGEO20SM	M30 x 2	M27 x 2	43.0	32	400		
EGEO25SM	M36 x 2	M33 x 2	48.0	41	400		
EGEO30SM	M42 x 2	M42 x 2	51.0	50	400		

EGE-R-ED

Full Dimensions

Swivel Connector
Flareless Swivel / BSPP with EOlastic Seal

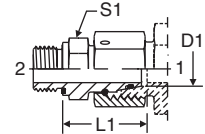

TUBE FITTING PART #	END SIZE		L1 (mm)	S1 (mm)	STANDARD Pressure Rating (bar)		
	1 Metric	2 BSPP			EO		
	A3C	71			MS		
EGE06LRED	M12 x 1.5	G 1/8A	24.5	14	315	315	
EGE08LRED	M14 x 1.5	G 1/4A	29.5	19	315	315	
EGE10LRED	M16 x 1.5	G 1/4A	27.5	19	315	315	
EGE12LRED	M18 x 1.5	G 3/8A	34.0	22	315	315	
EGE15LRED	M22 x 1.5	G 1/2A	32.0	27	315	315	
EGE18LRED	M26 x 1.5	G 1/2A	31.5	27	315	315	
EGE22LRED	M30 x 2	G 3/4A	32.5	32	160	160	
EGE28LRED	M36 x 2	G 1A	35.0	41	160	160	
EGE35LRED	M45 x 2	G 1 1/4A	42.5	50	160	160	
EGE42LRED	M52 x 2	G 1 1/2A	46.5	55	160	160	
EGE06SRED	M14 x 1.5	G 1/4A	27.0	19	630	630	
EGE08SRED	M16 x 1.5	G 1/4A	29.5	19	630	630	
EGE10SRED	M18 x 1.5	G 3/8A	32.0	22	630	630	
EGE12SRED	M20 x 1.5	G 3/8A	34.0	22	630	630	
EGE14SRED	M22 x 1.5	G 1/2A	36.5	27	630	630	
EGE16SRED	M24 x 1.5	G 1/2A	37.0	27	400	400	
EGE20SRED	M30 x 2	G 3/4A	43.0	32	400	400	
EGE25SRED	M36 x 2	G 1A	48.0	41	400	400	
EGE30SRED	M42 x 2	G 1 1/4A	51.0	50	400	400	
EGE38SRED	M52 x 2	G 1 1/2A	60.0	55	315	315	



EGE-M-ED

Full Dimensions

Swivel Connector
Flareless Swivel / Metric with EOlastic Seal

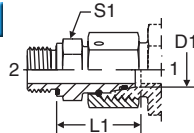

TUBE FITTING PART #	END SIZE		L1 (mm)	S1 (mm)	STANDARD Pressure Rating (bar)		
	1 Metric	2 Metric			EO		
	A3C	71			MS		
EGE06LMED	M12 x 1.5	M10 x 1	24.5	14	315	315	
EGE08LMED	M14 x 1.5	M12 x 1.5	26.5	17	315	315	
EGE10LMED	M16 x 1.5	M14 x 1.5	27.5	19	315	315	
EGE12LMED	M18 x 1.5	M16 x 1.5	30.5	22	315	315	
EGE15LMED	M22 x 1.5	M18 x 1.5	31.5	24	315	315	
EGE18LMED	M26 x 1.5	M22 x 1.5	31.5	27	315	315	
EGE22LMED	M30 x 2	M26 x 1.5	32.5	32	160	160	
EGE28LMED	M36 x 2	M33 x 2	35.0	41	160	160	
EGE35LMED	M45 x 2	M42 x 2	42.5	50	160	160	
EGE42LMED	M52 x 2	M48 x 2	46.5	55	160	160	
EGE06SMED	M14 x 1.5	M12 x 1.5	27.0	17	630	630	
EGE08SMED	M16 x 1.5	M14 x 1.5	29.5	19	630	630	
EGE10SMED	M18 x 1.5	M16 x 1.5	32.0	22	630	630	
EGE12SMED	M20 x 1.5	M18 x 1.5	34.0	24	630	630	
EGE14SMED	M22 x 1.5	M20 x 1.5	36.5	27	630	630	
EGE16SMED	M24 x 1.5	M22 x 1.5	37.0	27	400	400	
EGE20SMED	M30 x 2	M27 x 2	43.0	32	400	400	
EGE25SMED	M36 x 2	M33 x 2	48.0	41	400	400	
EGE30SMED	M42 x 2	M42 x 2	51.0	50	400	400	
EGE38SMED	M52 x 2	M48 x 2	60.0	55	315	315	

SKA

Full Dimensions

Weld Nipple
24° Flareless / ISO 8434-4 Butt Weld

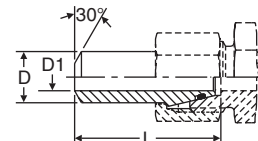

TUBE FITTING PART #	D (mm)	D1 (mm)	L (mm)	STANDARD Pressure Rating (bar)		
				EO		
				A3C	71	MS
SKA10x1	10	8	33.5	249		
SKA10x1.5		7		358	358	
SKA10x2		6		460	460	
SKA12x1.5	12	9	33.5	305	305	
SKA12x2		8		393	393	
SKA12x2.5		7		476	476	
SKA16x1.5	16	13	40.5	234		
SKA16x2		12		305	305	
SKA16x2.5		11		372	372	
SKA16x3		10		435	435	
SKA20x2	20	16	47.0	249	249	
SKA20x2.5		15		305		
SKA20x3		14		358	358	
SKA20x4		12		460		
SKA25x3	25	19	53.0	294	294	
SKA25x4		17		379	379	
SKA25x5		15		460	460	
SKA30x3	30	24	57.0	249	249	
SKA30x4		22		323	323	
SKA30x5		20		393	393	
SKA30x6		18		460	460	
SKA38x4	38	30	64.0	261	261	
SKA38x5		28		319	319	
SKA38x6		26		375	375	
SKA38x7		24		429	429	

Note: Weld fitting. Omit "A3C" in the part number for steel material.



VEE-UNF Full Dimensions

Adjustable Locknut 45° Elbow
24° Flareless / SAE-ORB

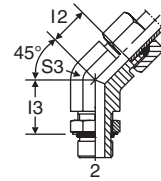

TUBE FITTING PART #	END SIZE		I2 (mm)	I3 (mm)	S3 (mm)	STANDARD Pressure Rating (bar)				
	1 (mm)	2 UN/UNF-2A				EO			EO-2	
						A3C	71	MS	A3C	71
VEE06L7/16UNF	6	7/16-20	9	19	14	315			315	
VEE08L7/16UNF	8	7/16-20	12	19	14	315			315	
VEE10L9/16UNF	10	9/16-18	12	24	19	315			315	
VEE12L9/16UNF	12	9/16-18	14	24	19	315			315	
VEE12L3/4UNF	12	3/4-16	14	24	19	315			315	
VEE15L3/4UNF	15	3/4-16	17	24	22	315			315	
VEE15L7/8UNF	15	7/8-14	17	24	22	315			315	
VEE18L7/8UNF	18	7/8-14	17	30	27	315			315	
VEE18L11/16UN	18	1 1/16-12	17	30	30	315			315	
VEE22L11/16UN	22	1 1/16-12	19	33	30	160			160	
VEE28L15/16UN	28	1 5/16-12	23	35	36	160			160	
VEE35L15/8UN	35	1 5/8-12	27	37	50	160			160	
VEE42L17/8UN	42	1 7/8-12	26	37	50	160			160	
VEE06S7/16UNF	6	7/16-20	9	18	14	400			400	
VEE08S9/16UNF	8	9/16-18	12	21	19	400			400	
VEE10S9/16UNF	10	9/16-18	13	21	19	400			400	
VEE12S3/4UNF	12	3/4-16	17	22	22	400			400	
VEE16S7/8UNF	16	7/8-14	16	29	27	400			400	
VEE20S11/16UN	20	1 1/16-12	16	31	30	400			400	
VEE25S11/16UN	25	1 1/16-12	30	33	36	400			400	
VEE30S15/8UN	30	1 5/8-12	24	35	50	250			250	
VEE38S17/8UN	38	1 7/8-12	21	35	50	250			250	

For EO-2 part number, insert "Z" between size and pressure series.
Example: VEE06ZL7/16UNFA3C

VEE-OR Full Dimensions

Adjustable Locknut 45° Elbow
24° Flareless / Metric ISO 6149

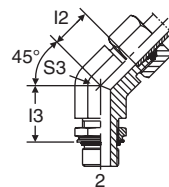

TUBE FITTING PART #	END SIZE		I2 (mm)	I3 (mm)	S3 (mm)	STANDARD Pressure Rating (bar)				
	1 (mm)	2 Metric				EO			EO-2	
						A3C	71	MS	A3C	71
VEE06LMOR	6	M10 x 1	14	20	14	315			315	
VEE08LMOR	8	M12 x 1.5	16	22	14	315			315	
VEE10LMOR	10	M14 x 1.5	17	25	19	315			315	
VEE12LMOR	12	M16 x 1.5	19	26	19	315			315	
VEE15LMOR	15	M18 x 1.5	21	30	22	315			315	
VEE18LMOR	18	M22 x 1.5	24	33	27	315			315	
VEE22LM27x2OR	22	M27 x 2	28	35	30	160			160	
VEE28LMOR	28	M33 x 2	31	38	36	160			160	
VEE35LMOR	35	M42 x 2	38	48	50	160			160	
VEE42LMOR	42	M48 x 2	38	49	50	160			160	
VEE06SMOR	6	M12 x 1.5	15	22	14	400			400	
VEE08SMOR	8	M14 x 1.5	17	26	19	400			400	
VEE10SMOR	10	M16 x 1.5	18	27	19	400			400	
VEE12SMOR	12	M18 x 1.5	22	31	22	400			400	
VEE16SMOR	16	M22 x 1.5	25	35	27	400			400	
VEE20SMOR	20	M27 x 2	28	39	30	400			400	
VEE25SMOR	25	M33 x 2	30	44	36	315			315	
VEE30SMOR	30	M42 x 2	36	51	50	250			250	
VEE38SMOR	38	M48 x 2	34	54	50	200			200	

For EO-2 part number, insert "Z" between size and pressure series.
Example: VEE06ZLMORA3C



VEE-R Full Dimensions

Adjustable Locknut 45° Elbow
24° Flareless / BSPP ORR

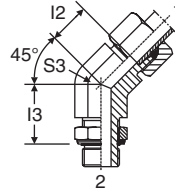

TUBE FITTING PART #	END SIZE		i (mm)	I2 (mm)	S3 (mm)	STANDARD Pressure Rating (bar)				
	1 (mm)	2 BSPP				EO			EO-2	
						A3C	71	MS	A3C	71
VEE06LR	6	G 1/8A	7	9	14	315			315	
VEE08LR	8	G 1/4A	9	12	14	315			315	
VEE10LR	10	G 1/4A	9	12	19	315			315	
VEE12LR	12	G 3/8A	9	14	19	250			250	
VEE15LR	15	G 1/2A	13	17	22	250			250	
VEE18LR	18	G 1/2A	13	17	27	250			250	
VEE22LR	22	G 3/4A	13	19	30	160			160	
VEE28LR	28	G 1A	15	23	36	160			160	
VEE35LR	35	G 1 1/4A	15	27	50	160			160	
VEE42LR	42	G 1 1/2A	15	26	50	160			160	
VEE06SR	6	G 1/4A	9	9	14	315			315	
VEE08SR	8	G 1/4A	9	12	19	315			315	
VEE10SR	10	G 3/8A	9	13	19	250			250	
VEE12SR	12	G 3/8A	9	17	19	250			250	
VEE16SR	16	G 1/2A	13	16	19	250			250	
VEE20SR	20	G 3/4A	12	16	27	250			250	
VEE25SR	25	G 1A	14	19	36	250			250	
VEE30SR	30	G 1 1/4A	15	24	50	160			160	
VEE38SR	38	G 1 1/2A	15	21	50	160			160	

For EO-2 part number, insert "Z" between size and pressure series.
Example: VEE06ZLRA3C

VEE-M Full Dimensions

Adjustable Locknut 45° Elbow
24° Flareless / Metric ORR

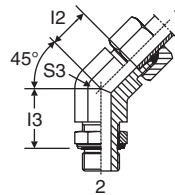

TUBE FITTING PART #	END SIZE		I2 (mm)	I3 (mm)	S3 (mm)	STANDARD Pressure Rating (bar)				
	1 (mm)	2 Metric				EO			EO-2	
						A3C	71	MS	A3C	71
VEE06LM	6	M10 x 1	9	21	14	315			315	
VEE08LM	8	M12 x 1.5	12	19	14	315			315	
VEE10LM	10	M14 x 1.5	12	24	19	315			315	
VEE12LM	12	M16 x 1.5	14	25	19	315			315	
VEE15LM	15	M18 x 1.5	17	24	22	315			315	
VEE18LM	18	M22 x 1.5	17	31	27	250			250	
VEE22LM27X2	22	M27 x 2	19	31	30	160			160	
VEE28LM	28	M33 x 2	23	35	36	160			160	
VEE35LM	35	M42 x 2	27	37	50	160			160	
VEE42LM	42	M48 x 2	26	37	50	160			160	
VEE06SM	6	M12 x 1.5	9	19	14	315			315	
VEE08SM	8	M14 x 1.5	12	19	19	315			315	
VEE10SM	10	M16 x 1.5	13	23	19	315			315	
VEE12SM	12	M18 x 1.5	17	25	19	315			315	
VEE16SM	16	M22 x 1.5	16	30	19	250			250	
VEE20SM	20	M27 x 2	16	35	27	250			250	
VEE25SM	25	M33 x 2	19	37	36	160			160	
VEE30SM	30	M42 x 2	24	37	50	160			160	
VEE38SM	38	M48 x 2	21	38	50	160			160	

For EO-2 part number, insert "Z" between size and pressure series.
Example: VEE06ZLMA3C



W Full Dimensions

Elbow Union
24° Flareless / 24° Flareless

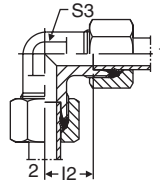

TUBE FITTING PART #	END SIZE			S3 (only Stainless Steel)	STANDARD Pressure Rating (bar)				
	1 & 2 (mm)	I 2 (mm)	S3 (mm)		EO			EO-2	
					A3C	71	MS	A3C	71
* W04LL	4	11	9	9	100	100	65	100	
* W06LL	6	10	11	9	100	100	65	100	
* W08LL	8	12	12	12	100	100	65		
* W10LL	10	13	14	12	100		65		
* W12LL	12	13	17	14	100				
* W06L	6	12	12	12	315	315	205	315	315
* W08L	8	14	14	12	315	315	205	315	315
* W10L	10	15	17	14	315	315	205	315	315
* W12L	12	17	19	17	315	315	205	315	315
W15L	15	21	19	19	315	315	205	315	315
W18L	18	24	24	24	315	315	205	315	315
W22L	22	28	27	27	160	160	104	160	160
W28L	28	31	36	36	160	160	104	160	160
W35L	35	35	41	41	160	160	104	160	160
W42L	42	40	50	50	160	160	104	160	160
* W06S	6	16	14	12	630	630	410	630	630
* W08S	8	17	17	14	630	630	410	630	630
* W10S	10	18	19	17	630	630	410	630	630
* W12S	12	22	22	17	630	630	410	630	630
W14S	14	22	19	19	630	630	410	630	630
W16S	16	25	24	24	400	400	260	400	400
W20S	20	27	27	27	400	400	260	400	400
W25S	25	30	36	36	400	400	260	400	400
W30S	30	36	41	41	400	400	260	400	400
W38S	38	41	50	50	315	315	205	315	315

* Extruded body.

For EO-2 part number, insert "Z" between size and pressure series.

Example: W04ZLLA3C



WSV Full Dimensions

Bulkhead Union Elbow
24° Flareless / 24° Flareless

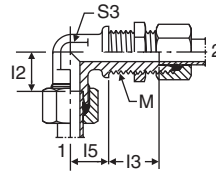

TUBE FITTING PART #	END SIZE 1 & 2 (mm)	M Metric	I2 (mm)	I3 (mm)	I5 (mm)	S3 (mm)	STANDARD Pressure Rating (bar)				
							EO			EO-2	
							A3C	71	MS	A3C	71
WSV06L	6	M12 x 1.5	12.0	27.0	14	12	315	315	205	315	315
WSV08L	8	M14 x 1.5	14.0	27.0	17	12	315	315	205	315	315
WSV10L	10	M16 x 1.5	15.0	28.0	18	14	315	315	205	315	315
WSV12L	12	M18 x 1.5	17.0	29.0	20	17	315	315	205	315	315
WSV15L	15	M22 x 1.5	21.0	31.0	23	19	315	315	205	315	315
WSV18L	18	M26 x 1.5	23.5	32.5	24	24	315	315	205	315	315
WSV22L	22	M30 x 2	27.5	34.5	30	27	160	160		160	160
WSV28L	28	M36 x 2	30.5	35.5	34	36	160	160		160	160
WSV35L	35	M45 x 2	34.5	36.5	39	41	160	160		160	160
WSV42L	42	M52 x 2	40.0	36.0	43	50	160	160		160	160
WSV06S	6	M14 x 1.5	16.0	29.0	17	12	630	630		630	630
WSV08S	8	M16 x 1.5	17.0	29.0	18	14	630	630		630	630
WSV10S	10	M18 x 1.5	17.5	29.5	20	17	630	630		630	630
WSV12S	12	M20 x 1.5	21.5	30.5	21	17	630	630		630	630
WSV14S	14	M22 x 1.5	22.0	32.0	23	19	630	630		630	630
WSV16S	16	M24 x 1.5	24.5	31.5	24	24	400	400		400	400
WSV20S	20	M30 x 2	26.5	33.5	30	27	400	400		400	400
WSV25S	25	M36 x 2	30.0	35.0	34	36	400	400		400	400
WSV30S	30	M42 x 2	35.5	37.5	39	41	400	400		400	400
WSV38S	38	M52 x 2	41.0	37.0	43	50	315	315		315	315

For EO-2 part number, insert "Z" between size and pressure series.
Example: WSV06ZLA3C

WE-NPT Full Dimensions

Male Elbow
24° Flareless / NPT

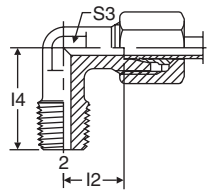

TUBE FITTING PART #	END SIZE		I2 (mm)	I4 (mm)	S3 (mm)	STANDARD Pressure Rating (bar)		
	1 (mm)	2 NPT				EO		
						A3C	71	MS
* WE04LL1/8NPT	4	1/8-27	11.0	17	11	100		
* WE06LL1/8NPT	6	1/8-27	9.5	17	11	100		65
* WE08LL1/8NPT	8	1/8-27	11.5	20	12	100		65
* WE06L1/8NPT	6	1/8-27	12.0	20	12	315	315	205
* WE08L1/4NPT	8	1/4-18	14.0	26	14	315	315	205
* WE10L1/4NPT	10	1/4-18	15.0	27	17	315	315	205
* WE12L3/8NPT	12	3/8-18	17.0	28	19	315	315	205
WE15L1/2NPT	15	1/2-14	21.0	34	19	315	315	
WE18L1/2NPT	18	1/2-14	23.5	36	24	315	315	
WE22L3/4NPT	22	3/4-14	27.5	42	27	160		
WE28L1NPT	28	1-11 1/2	30.5	48	36	160		
WE35L11/4NPT	35	1 1/4-11 1/2	34.5	54	41	160		
WE42L11/2NPT	42	1 1/2-11 1/2	40.0	61	50	160		
* WE06S1/4NPT	6	1/4-18	16.0	26	14	630	630	410
* WE08S1/4NPT	8	1/4-18	17.0	27	17	630	630	
* WE10S3/8NPT	10	3/8-18	17.5	28	19	630	630	
* WE12S3/8NPT	12	3/8-18	17.0	28	22	630	630	
WE14S1/2NPT	14	1/2-14	22.0	34	19	630	630	
WE16S1/2NPT	16	1/2-14	24.5	36	24	400	400	
WE20S3/4NPT	20	3/4-14	26.5	42	27	400		
WE25S1NPT	25	1-11 1/2	30.0	48	36	400		
WE30S11/4NPT	30	1 1/4-11 1/2	35.5	54	41	400		
WE38S11/2NPT	38	1 1/2-11 1/2	41.0	61	50	315		

* Extruded body.



WE-R keg

Full Dimensions

Male Elbow
24° Flareless / BSPT

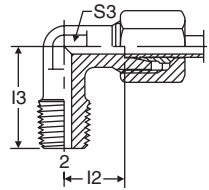

TUBE FITTING PART #	END SIZE		I2 (mm)	I3 (mm)	S3 (mm)	STANDARD Pressure Rating (bar)		
	1 (mm)	2 BSPT				EO		
						A3C	71	MS
* WE04LLR	4	R1/8 keg.	11	17	11	100	100	65
* WE06LLR	6	R1/8 keg.	10	17	11	100	100	65
* WE08LLR	8	R1/8 keg.	12	20	12	100	100	65
* WE10LLR	10	R1/4 keg.	13	23	14	100		65
* WE12LLR	12	R1/4 keg.	13	23	17	100		65
* WE06LR	6	R1/8 keg.	12	20	12	315	315	205
* WE08LR	8	R1/4 keg.	14	26	14	315	315	205
* WE10LR	10	R1/4 keg.	15	27	17	315	315	205
* WE12LR	12	R3/8 keg.	17	28	19	315	315	205
WE15LR	15	R1/2 keg.	21	34	19	315	315	205
WE18LR	18	R1/2 keg.	24	36	24	315	315	205
* WE06SR	6	R1/4 keg.	16	26	14	400	400	260
* WE08SR	8	R1/4 keg.	17	27	17	400	400	260
* WE10SR	10	R3/8 keg.	18	28	19	400	400	260
* WE12SR	12	R3/8 keg.	22	28	22	400	400	
WE14SR	14	R1/2 keg.	22	32	19	400	400	
WE16SR	16	R1/2 keg.	25	32	24	400	400	260

* Extruded body.
Note: keg. refers to taper threads.

- How to Order
- Specs
- Assembly / Installation
- Reference

WE-M keg

Full Dimensions

Male Elbow
24° Flareless / Metric Taper Thread

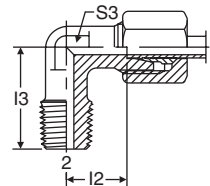

TUBE FITTING PART #	END SIZE		I2 (mm)	I3 (mm)	S3 (mm)	STANDARD Pressure Rating		
	1 (mm)	2 Metric				EO		
						A3C	71	MS
* WE04LLM	4	M8 x 1 keg.	11	17	11	100	100	
WE04LLM6KEG	4	M6 x 1 keg.	11	17	9	100		
* WE06LLM	6	M10 x 1 keg.	10	17	11	100	100	
* WE08LLM	8	M10 x 1 keg.	12	20	12	100	100	
* WE06LM	6	M10 x 1 keg.	12	20	12	315	315	
* WE08LM	8	M12 x 1.5 keg.	14	26	14	315	315	
* WE10LM	10	M14 x 1.5 keg.	15	27	17	315	315	
WE12LM	12	M16 x 1.5 keg.	17	28	19	315	315	
WE15LM	15	M18 x 1.5 keg.	21	32	19	315	315	
WE18LM	18	M22 x 1.5 keg.	24	36	24	315	315	
* WE06SM	6	M12 x 1.5 keg.	16	26	14	400	400	
* WE08SM	8	M14 x 1.5 keg.	17	27	17	400	400	
* WE10SM	10	M16 x 1.5 keg.	18	28	19	400	400	
* WE12SM	12	M18 x 1.5 keg.	22	28	22	400	400	
WE14SM	14	M20 x 1.5 keg.	22	32	19	400		
WE16SM	16	M22 x 1.5 keg.	25	32	24	400		

* Extruded body.
Note: keg. refers to taper threads.

WEE-UNF Full Dimensions

Adjustable Locknut Elbow
24° Flareless / SAE-ORB

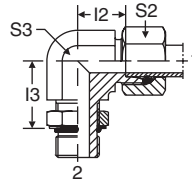

TUBE FITTING PART #	END SIZE		I 2 (mm)	I 3 (mm)	S 3 (mm)	STANDARD Pressure Rating (bar)				
	1 (mm)	2 UN / UNF				EO			EO-2	
						A3C	71	MS	A3C	71
WEE06L7/16UNF	6	7/16-20	14	19	14	315			315	
WEE08L7/16UNF	8	7/16-20	16	19	14	315			315	
WEE10L9/16UNF	10	9/16-18	17	24	19	315			315	
WEE12L9/16UNF	12	9/16-18	19	25	19	315			315	
WEE12L3/4UNF	12	3/4-16	19	25	19	315			315	
WEE15L3/4UNF	15	3/4-16	21	28	22	315			315	
WEE15L7/8UNF	15	7/8-14	21	28	22	315			315	
WEE18L7/8UNF	18	7/8-14	24	32	27	315			315	
WEE18L11/16UN	18	1 1/16-12	24	32	30	315			315	
WEE22L11/16UN	22	1 1/16-12	28	35	30	160			160	
WEE28L15/16UN	28	1 5/16-12	31	42	36	160			160	
WEE35L15/8UN	35	1 5/8-12	38	46	50	160			160	
WEE42L17/8UN	42	1 7/8-12	38	47	50	160			160	
WEE06S7/16UNF	6	7/16-20	15	20	14	400			400	
WEE08S9/16UNF	8	9/16-18	17	25	19	400			400	
WEE10S9/16UNF	10	9/16-18	18	26	19	400			400	
WEE12S3/4UNF	12	3/4-16	22	30	22	400			400	
WEE16S7/8UNF	16	7/8-14	25	34	27	400			400	
WEE20S11/16UN	20	1 1/16-12	28	37	30	400			400	
WEE25S11/16UN	25	1 1/16-12	30	50	36	400			400	
WEE30S15/8UN	30	1 5/8-12	36	50	50	250			250	
WEE38S17/8UN	38	1 7/8-12	34	51	50	250			250	

For EO-2 part number, insert "Z" between size and pressure series.
Example: WEE06ZL7/16UNFA3C

WEE-OR Full Dimensions

Adjustable Locknut Elbow
24° Flareless / Metric ISO 6149

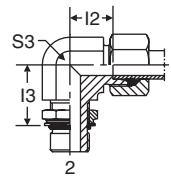

TUBE FITTING PART #	END SIZE		I 2 (mm)	I 3 (mm)	S 3 (mm)	STANDARD Pressure Rating (bar)				
	1 (mm)	2 Metric				EO			EO-2	
						A3C	71	MS	A3C	71
WEE04LLMOR	4	M8 x 1	20	7	12				250	
WEE04LLM10x1MOR	4	M10 x 1	20	7	11				250	
WEE06LLMOR	6	M10 x 1	20	7	14				250	
WEE06LLM12x1.5MOR	6	M12 x 1.5	23	10	14				250	
WEE06LMOR	6	M10 x 1	20	7	14	315			315	
WEE08LMOR	8	M12 x 1.5	22	10	14	315			315	
WEE10LMOR	10	M14 x 1.5	25	10	19	315			315	
WEE12LMOR	12	M16 x 1.5	26	10	19	315			315	
WEE15LMOR	15	M18 x 1.5	30	11	22	315			315	
WEE18LMOR	18	M22 x 1.5	33	12	27	315			315	
WEE22LM27X2OR	22	M27 x 2	35	14	30	160			160	
WEE28LMOR	28	M33 x 2	38	14	36	160			160	
WEE35LMOR	35	M42 x 2	48	14	50	160			160	
WEE42LMOR	42	M48 x 2	49	16	50	160			160	
WEE06SMOR	6	M12 x 1.5	22	10	14	400			400	
WEE08SMOR	8	M14 x 1.5	26	10	19	400			400	
WEE10SMOR	10	M16 x 1.5	27	11	19	400			400	
WEE12SMOR	12	M18 x 1.5	31	12	22	400			400	
WEE16SMOR	16	M22 x 1.5	35	14	27	400			400	
WEE20SMOR	20	M27 x 2	39	16	30	400			400	
WEE25SMOR	25	M33 x 2	44	16	36	315			315	
WEE30SMOR	30	M42 x 2	51	17	50	250			250	
WEE38SMOR	38	M48 x 2	54	19	50	200			200	

For EO-2 part number, insert "Z" between size and pressure series.
Example: WEE04ZLLMORA3C



WEE-R Full Dimensions

Adjustable Locknut Elbow
24° Flareless / BSPP ORR

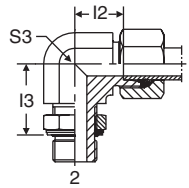

TUBE FITTING PART #	END SIZE		I2 (mm)	I3 (mm)	S3 (mm)	STANDARD Pressure Rating (bar)				
	1 (mm)	2 BSPP				EO			EO-2	
						A3C	71	MS	A3C	71
WEE04LLR	4	G 1/8A	11	20	11				250	
WEE06LLR	6	G 1/8A	11	20	11				250	
WEE06LR	6	G 1/8A	14	19	14	315			315	
WEE08LR	8	G 1/4A	16	23	14	315			315	
WEE10LR	10	G 1/4A	17	25	19	315			315	
WEE12LR	12	G 3/8A	19	28	19	250			250	
WEE15LR	15	G 1/2A	21	30	22	250			250	
WEE18LR	18	G 1/2A	24	36	27	250			250	
WEE22LR	22	G 3/4A	28	36	30	160			160	
WEE28LR	28	G 1A	31	44	36	160			160	
WEE35LR	35	G 1 1/4A	38	50	50	160			160	
WEE42LR	42	G 1 1/2A	38	52	50	160			160	
WEE06SR	6	G 1/4A	15	23	14	315			315	
WEE08SR	8	G 1/4A	17	27	19	315			315	
WEE10SR	10	G 3/8A	18	29	19	250			250	
WEE12SR	12	G 3/8A	22	29	22	250			250	
WEE16SR	16	G 1/2A	25	36	27	250			250	
WEE20SR	20	G 3/4A	28	39	30	250			250	
WEE25SR	25	G 1A	30	44	36	250			250	
WEE30SR	30	G 1 1/4A	36	49	50	160			160	
WEE38SR	38	G 1 1/2A	34	55	50	160			160	

For EO-2 part number, insert "Z" between size and pressure series.
Example: WEE04ZLLRA3C

WEE-M Full Dimensions

Adjustable Locknut Elbow
24° Flareless / Metric ORR

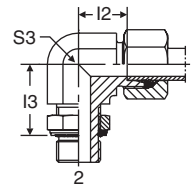

TUBE FITTING PART #	END SIZE		I2 (mm)	I3 (mm)	S3 (mm)	STANDARD Pressure Rating (bar)				
	1 (mm)	2 Metric				EO			EO-2	
						A3C	71	MS	A3C	71
WEE06LM	6	M10 x 1	14	20	14	315			315	
WEE08LM	8	M12 x 1.5	16	22	14	315			315	
WEE10LM	10	M14 x 1.5	17	24	19	315			315	
WEE12LM	12	M16 x 1.5	19	25	19	315			315	
WEE15LM	15	M18 x 1.5	21	31	22	315			315	
WEE18LM	18	M22 x 1.5	24	33	27	250			250	
WEE22LM27X2	22	M27 x 2	28	36	30	160			160	
WEE28LM	28	M33 x 2	31	39	36	160			160	
WEE35LM	35	M42 x 2	38	49	50	160			160	
WEE42LM	42	M48 x 2	38	50	50	160			160	
WEE06SM	6	M12 x 1.5	15	22	14	315			315	
WEE08SM	8	M14 x 1.5	17	26	19	315			315	
WEE10SM	10	M16 x 1.5	18	27	19	315			315	
WEE12SM	12	M18 x 1.5	22	31	22	315			315	
WEE16SM	16	M22 x 1.5	25	36	27	250			250	
WEE20SM	20	M27 x 2	28	39	30	250			250	
WEE25SM	25	M33 x 2	30	44	36	160			160	
WEE30SM	30	M42 x 2	36	51	50	160			160	
WEE38SM	38	M48 x 2	34	54	50	160			160	

For EO-2 part number, insert "Z" between size and pressure series.
Example: WEE06ZLMA3C



EW Full Dimensions

Swivel Nut Elbow
24° Flareless / Flareless Swivel

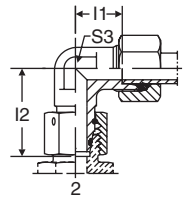

TUBE FITTING PART #	END SIZE		I1 (mm)	I2 (mm)	S3 (mm)	STANDARD Pressure Rating (bar)				
	1 (mm)	2 Metric				EO			EO-2	
						A3C	71	MS	A3C	71
EW06L	6	M12 x 1.5	12.0	26.0	12	315	315		315	315
EW08L	8	M14 x 1.5	14.0	27.5	12	315	315		315	315
EW10L	10	M16 x 1.5	15.0	29.0	14	315	315		315	315
EW12L	12	M18 x 1.5	17.0	29.5	17	315	315		315	315
EW15L	15	M22 x 1.5	21.0	32.5	19	315	315		315	315
EW18L	18	M26 x 1.5	23.5	35.5	24	315	315		315	315
EW22L	22	M30 x 2	27.5	38.5	27	160	160		160	160
EW28L	28	M36 x 2	30.5	41.5	36	160	160		160	160
EW35L	35	M45 x 2	34.5	51.0	41	160	160		160	160
EW42L	42	M52 x 2	40.0	56.0	50	160	160		160	160
EW06S	6	M14 x 1.5	16.0	27.0	12	630	630		630	630
EW08S	8	M16 x 1.5	17.0	27.5	14	630	630		630	630
EW10S	10	M18 x 1.5	17.5	30.0	17	630	630		630	630
EW12S	12	M20 x 1.5	21.5	31.0	17	630	630		630	630
EW14S	14	M22 x 1.5	22.0	35.0	19	630	630		630	630
EW16S	16	M24 x 1.5	24.5	36.5	24	400	400		400	400
EW20S	20	M30 x 2	26.5	44.5	27	400	400		400	400
EW25S	25	M36 x 2	30.0	50.0	36	400	400		400	400
EW30S	30	M42 x 2	35.5	55.0	41	400	400		400	400
EW38S	38	M52 x 2	41.0	63.0	50	315	315		315	315

For EO-2 part number, insert "Z" between size and pressure series.
Example: EW06ZLA3C



EW-R-ED Full Dimensions

Assembled Adjustable Swivel Elbow
24° Flareless / BSPP with EOlastic Seal

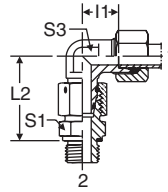

TUBE FITTING PART #	END SIZE		I 1 (mm)	L2 (mm)	S1 (mm)	S3 (mm)	STANDARD Pressure Rating (bar)					
	1 (mm)	2 BSPP					EO			EO-2		
							A3C	71	MS	A3C	71	
EW06LRED	6	G 1/8 A	12.0	34.5	14	12	315				315	
EW08LRED	8	G 1/4 A	14.0	37.5	19	12	315				315	
EW10LRED	10	G 1/4 A	15.0	40.0	19	14	315				315	
EW12LRED	12	G 3/8 A	17.0	42.0	22	17	315				315	
EW15LRED	15	G 1/2 A	21.0	46.5	27	19	315				315	
EW18LRED	18	G 1/2 A	23.5	50.0	27	24	315				315	
EW22LRED	22	G 3/4 A	27.5	55.0	32	27	160				160	
EW28LRED	28	G 1A	30.5	59.0	41	36	160				160	
EW35LRED	35	G 1 1/4 A	34.5	68.5	50	41	160				160	
EW42LRED	42	G 1 1/2 A	40.0	75.0	55	50	160				160	
EW06SRED	6	G 1/4 A	16.0	40.0	19	12	630				630	
EW08SRED	8	G 1/4 A	17.0	42.5	19	14	630				630	
EW10SRED	10	G 3/8 A	17.5	45.0	22	17	630				630	
EW12SRED	12	G 3/8 A	21.5	48.0	22	17	630				630	
EW14SRED	14	G 1/2 A	22.0	54.0	27	19	630				630	
EW16SRED	16	G 1/2 A	24.5	55.0	27	24	400				400	
EW20SRED	20	G 3/4 A	26.5	65.0	32	27	400				400	
EW25SRED	25	G 1A	30.0	73.0	41	36	400				400	
EW30SRED	30	G 1 1/4 A	35.5	78.5	50	41	400				400	
EW38SRED	38	G 1 1/2 A	41.0	89.0	55	50	315				315	

For EO-2 part number, insert "Z" between size and pressure series.
Example: EW06ZLREDA3C

EW-M-ED Full Dimensions

Assembled Adjustable Swivel Elbow
24° Flareless / Metric Parallel with EOlastic Seal

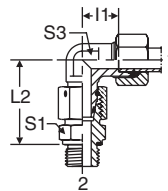

TUBE FITTING PART #	END SIZE		I 1 (mm)	L2 (mm)	S1 (mm)	S3 (mm)	STANDARD Pressure Rating (bar)					
	1 (mm)	2 Metric					EO			EO-2		
							A3C	71	MS	A3C	71	
EW06LMED	6	M10 x 1	12.0	34.5	14	12	315				315	
EW08LMED	8	M12 x 1.5	14.0	37.5	17	12	315				315	
EW10LMED	10	M14 x 1.5	15.0	40.0	19	14	315				315	
EW12LMED	12	M16 x 1.5	17.0	42.0	22	17	315				315	
EW15LMED	15	M18 x 1.5	21.0	46.0	24	19	315				315	
EW18LMED	18	M22 x 1.5	23.5	50.0	27	24	315				315	
EW22LMED	22	M26 x 1.5	27.5	55.0	32	27	160				160	
EW28LMED	28	M33 x 2	30.5	59.0	41	36	160				160	
EW35LMED	35	M42 x 2	34.5	68.5	50	41	160				160	
EW42LMED	42	M48 x 2	40.0	75.0	55	50	160				160	
EW06SMED	6	M12 x 1.5	16.0	40.0	17	12	630				630	
EW08SMED	8	M14 x 1.5	17.0	42.5	19	14	630				630	
EW10SMED	10	M16 x 1.5	17.5	45.0	22	17	630				630	
EW12SMED	12	M18 x 1.5	21.5	48.0	24	17	630				630	
EW14SMED	14	M20 x 1.5	22.0	54.0	27	19	630				630	
EW16SMED	16	M22 x 1.5	24.5	55.0	27	24	400				400	
EW20SMED	20	M27 x 2	26.5	65.0	32	27	400				400	
EW25SMED	25	M33 x 2	30.0	73.0	41	36	400				400	
EW30SMED	30	M42 x 2	35.5	78.5	50	41	400				400	
EW38SMED	38	M48 x 2	41.0	89.0	55	50	315				315	

For EO-2 part number, insert "Z" between size and pressure series.
Example: EW06ZLMEDA3C



SWVE-R Full Dimensions

Banjo Elbow
24° Flareless / BSPP

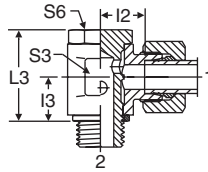

TUBE FITTING PART #	END SIZE		I2 (mm)	I3 (mm)	L3 (mm)	S3 (mm)	S6 (mm)	STANDARD Pressure		
	1 (mm)	2 BSPP						EO		
								A3C	71	MS
SWVE04LLR	4	G 1/8 A	11.5	10	21.0	14	14	63		
SWVE06LLR	6	G 1/8 A	10.0	10	21.5	14	14	63		
SWVE08LLR	8	G 1/8 A	11.0	10	21.0	14	14	63		
SWVE06LR	6	G 1/8 A	10.5	10	21.0	14	14	160		
SWVE08LR	8	G 1/4 A	13.0	13	27.0	19	19	160		
SWVE10LR	10	G 1/4 A	14.0	13	27.0	19	19	160		
SWVE12LR	12	G 3/8 A	15.5	15	32.0	22	21	100		
SWVE15LR	15	G 1/2 A	19.0	18	37.5	27	27	100		
SWVE18LR	18	G 1/2 A	20.5	21.5	44.0	30	27	100		
SWVE22LR	22	G 3/4 A	25.5	24	49.0	36	32	100		
SWVE06SR	6	G 1/4 A	15.0	13	27.0	19	19	160		
SWVE08SR	8	G 1/4 A	15.0	13	27.0	19	19	160		
SWVE10SR	10	G 3/8 A	16.0	15	32.0	22	22	100		
SWVE12SR	12	G 3/8 A	17.0	18	37.0	24	24	100		
SWVE14SR	14	G 1/2 A	20.0	18	37.0	27	27	100		
SWVE16SR	16	G 1/2 A	21.5	21.5	44.0	30	27	100		
SWVE20SR	20	G 3/4 A	24.5	24	49.0	36	32	100		

SWVE-M Full Dimensions

Banjo Elbow
24° Flareless / Metric Parallel

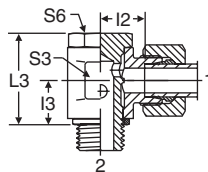

TUBE FITTING PART #	END SIZE		I2 (mm)	I3 (mm)	L3 (mm)	S3 (mm)	S6 (mm)	STANDARD Pressure		
	1 (mm)	2 Metric						EO		
								A3C	71	MS
SWVE04LLM	4	M8 x 1	10.5	8	17	12	12	63		
SWVE06LLM	6	M10 x 1	10.0	10	21	14	14	63		
SWVE08LLM	8	M10 x 1	11.0	10	21	14	14	63		
SWVE06LM	6	M10 x 1	10.5	10	21.5	14	14	160		
SWVE08LM	8	M12 x 1.5	12.0	12	25	17	17	160		
SWVE10LM	10	M14 x 1.5	14.0	13	27	19	19	160		
SWVE12LM	12	M16 x 1.5	15.5	15	32	22	21	100		
SWVE15LM	15	M18 x 1.5	17.5	18	37.5	24	24	100		
SWVE18LM	18	M22 x 1.5	20.5	21.5	44	30	27	100		
SWVE22LM	22	M26 x 1.5	25.5	24	49	36	32	100		
SWVE06SM	6	M12 x 1.5	14.0	12	25	17	17	160		
SWVE08SM	8	M14 x 1.5	15.0	13	27	19	19	160		
SWVE10SM	10	M16 x 1.5	16.0	15	32	22	22	100		
SWVE12SM	12	M18 x 1.5	17.0	18	37	24	24	100		
SWVE14SM	14	M20 x 1.5	20.0	18	37	27	27	100		
SWVE16SM	16	M22 x 1.5	21.5	21.5	44	30	27	100		
SWVE20SM	20	M27 x 2	24.5	24	49	36	32	100		



WH-R Full Dimensions

High Pressure Banjo Elbow
24° Flareless / BSPP

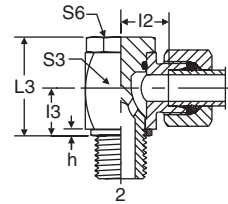

TUBE FITTING PART #	END SIZE		h (mm)	I2 (mm)	I3 (mm)	L3 (mm)	S3 (mm)	S6 (mm)	STANDARD Pressure Rating (bar)				
	1 (mm)	2 BSPP							EO			EO-2	
									A3C	71	MS	A3C	71
WH06LR	6	G 1/8 A	2.5	12.0	10.5	24	17	17	250	250	163		250
WH08LR	8	G 1/4 A	3.0	14.5	14.0	30	22	19	250	250	163		250
WH10LR	10	G 1/4 A	3.0	15.5	14.0	30	22	19	250	250	163		250
WH12LR	12	G 3/8 A	3.0	18.0	16.5	36	27	24	250	250	163		250
WH15LR	15	G 1/2 A	4.5	21.5	21.5	45	32	30	250	250	163		250
WH18LR	18	G 1/2 A	4.5	21.0	21.5	45	32	30	250	250	163		250
WH22LR	22	G 3/4 A	3.5	27.5	24.0	53	41	36	160	160			160
WH28LR	28	G 1 A	3.5	32.0	30.5	66	50	46	160	160			160
WH35LR	35	G 1 1/4 A	3.5	36.0	35.5	76	60	55	160	160			160
WH42LR	42	G 1 1/2 A	3.5	40.5	40.5	87	70	60	160	160			160
WH06SR	6	G 1/4 A	3.0	16.5	14.0	30	22	19	315	315	205		315
WH08SR	8	G 1/4 A	3.0	16.5	14.0	30	22	19	315	315	205		315
WH10SR	10	G 3/8 A	3.0	18.5	16.5	36	27	24	315	315	205		315
WH12SR	12	G 3/8 A	3.0	18.5	16.5	36	27	24	315	315	205		315
WH14SR	14	G 1/2 A	4.5	22.5	21.5	45	32	30	315	315			315
WH16SR	16	G 1/2 A	4.5	22.0	21.5	45	32	30	315	315			315
WH20SR	20	G 3/4 A	3.5	26.5	24.0	53	41	36	160	160			160
WH25SR	25	G 1 A	3.5	31.5	30.5	66	50	46	160	160			160
WH30SR	30	G 1 1/4 A	3.5	37.0	34.5	76	60	55	160	160			160
WH38SR	38	G 1 1/2 A	3.5	41.5	40.5	87	70	60	160	160			160

For EO-2 part number, insert "Z" between size and pressure series.
Example: WH06ZLRA3C

WH-M Full Dimensions

High Pressure Banjo Elbow
24° Flareless / Metric Parallel

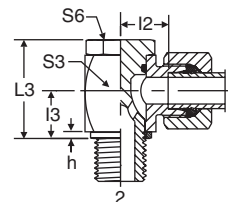

TUBE FITTING PART #	END SIZE		h (mm)	I2 (mm)	I3 (mm)	L3 (mm)	S3 (mm)	S6 (mm)	STANDARD Pressure Rating (bar)				
	1 (mm)	2 Metric							EO			EO-2	
									A3C	71	MS	A3C	71
WH06LM	6	M10 x 1	2.5	12.0	10.5	24.0	17	17	250	250			250
WH08LM	8	M12 x 1.5	3.0	14.5	14.0	30.0	22	19	250	250			250
WH10LM	10	M14 x 1.5	3.0	15.5	14.0	30.0	22	19	250	250			250
WH12LM	12	M16 x 1.5	3.0	18.0	16.5	36.0	27	24	250	250			250
WH15LM	15	M18 x 1.5	3.0	21.5	18.5	39.5	30	30	250	250			250
WH18LM	18	M22 x 1.5	4.5	21.0	21.5	45.0	32	30	250	250			250
WH22LM	22	M26 x 1.5	3.5	27.5	24.0	53.0	41	36	160	160			160
WH28LM	28	M33 x 2	3.5	32.0	30.5	66.0	50	46	160	160			160
WH35LM	35	M42 x 2	3.5	36.0	35.5	76.0	60	55	160	160			160
WH42LM	42	M48 x 2	3.5	40.5	40.5	87.0	70	60	160	160			160
WH06SM	6	M12 x 1.5	3.0	16.5	14.0	30.0	22	19	315	315			315
WH08SM	8	M14 x 1.5	3.0	16.5	14.0	30.0	22	19	315	315			315
WH10SM	10	M16 x 1.5	3.0	18.5	16.5	36.0	27	24	315	315			315
WH12SM	12	M18 x 1.5	3.0	20.0	18.5	39.5	27	27	315	315			315
WH14SM	14	M20 x 1.5	3.0	22.5	20.0	43.5	32	30	315	315			315
WH16SM	16	M22 x 1.5	4.5	22.0	21.5	45.0	32	30	315	315			315
WH20SM	20	M27 x 2	3.5	26.5	24.0	53.0	41	36	160	160			160
WH25SM	25	M33 x 2	3.5	31.5	30.5	66.0	50	46	160	160			160
WH30SM	30	M42 x 2	3.5	37.0	35.5	76.0	60	55	160	160			160
WH38SM	38	M48 x 2	3.5	41.5	40.5	87.0	70	60	160	160			160

For EO-2 part number, insert "Z" between size and pressure series.
Example: WH06ZLMA3C



WH-R-KDS Full Dimensions

High Pressure Banjo Elbow
24° Flareless / BSPP

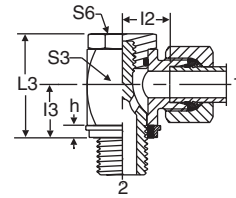

TUBE FITTING PART #	END SIZE		h (mm)	I2 (mm)	I3 (mm)	L3 (mm)	S3 (mm)	S6 (mm)	STANDARD Pressure Rating (bar)				
	1 (mm)	2 BSPP							EO			EO-2	
									A3C	71	MS	A3C	71
WH06LRKDS	6	G 1/8 A	2.5	12.0	10.5	24	17	17	315	315		315	315
WH08LRKDS	8	G 1/4 A	3.0	14.5	14.0	30	22	19	315	315		315	315
WH10LRKDS	10	G 1/4 A	3.0	15.5	14.0	30	22	19	315	315		315	315
WH12LRKDS	12	G 3/8 A	3.0	18.0	16.5	36	27	24	315	315		315	315
WH15LRKDS	15	G 1/2 A	4.5	21.5	21.5	45	32	30	315	315		315	315
WH18LRKDS	18	G 1/2 A	4.5	21.0	21.5	45	32	30	315	315		315	315
WH22LRKDS	22	G 3/4 A	3.5	27.5	24.0	53	41	36	160	160		160	160
WH28LRKDS	28	G 1 A	3.5	32.0	30.5	66	50	46	160	160		160	160
WH35LRKDS	35	G 1 1/4 A	3.5	36.0	35.5	76	60	55	160			160	
WH42LRKDS	42	G 1 1/2 A	3.5	40.5	40.5	87	70	60	160			160	
WH06SRKDS	6	G 1/4 A	3.0	16.5	14.0	30	22	19	400	400		400	400
WH08SRKDS	8	G 1/4 A	3.0	16.5	14.0	30	22	19	400	400		400	400
WH10SRKDS	10	G 3/8 A	3.0	18.5	16.5	36	27	24	400	400		400	400
WH12SRKDS	12	G 3/8 A	3.0	18.5	16.5	36	27	24	400	400		400	400
WH14SRKDS	14	G 1/2 A	4.5	22.5	21.5	45	32	30	400	400		400	400
WH16SRKDS	16	G 1/2 A	4.5	22.0	21.5	45	32	30	315	315		315	315
WH20SRKDS	20	G 3/4 A	3.5	26.5	24.0	53	41	36	315	315		315	315
WH25SRKDS	25	G 1 A	3.5	31.5	30.5	66	50	46	250			250	
WH30SRKDS	30	G 1 1/4 A	3.5	37.0	34.5	76	60	55	160			160	
WH38SRKDS	38	G 1 1/2 A	3.5	41.5	40.5	87	70	60	160			160	

For EO-2 part number, insert "Z" between size and pressure series.
Example: WH06ZLRKDSA3C

WH-M-KDS Full Dimensions

High Pressure Banjo Elbow
Banjo Metric / Flareless

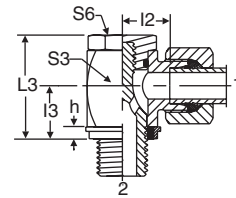

TUBE FITTING PART #	END SIZE		h (mm)	I2 (mm)	I3 (mm)	L3 (mm)	S3 (mm)	S6 (mm)	STANDARD Pressure Rating (bar)				
	1 (mm)	2 BSPP							EO			EO-2	
									A3C	71	MS	A3C	71
WH06LMKDS	6	M10 x 1	2.5	12.0	10.5	24	17	17	315			315	
WH08LMKDS	8	M12 x 1.5	3.0	14.5	14.0	30	22	19	315			315	
WH10LMKDS	10	M14 x 1.5	3.0	15.5	14.0	30	22	19	315			315	
WH12LMKDS	12	M16 x 1.5	3.0	18.0	16.5	36	27	24	315			315	
WH15LMKDS	15	M18 x 1.5	3.0	20.5	18.5	39.5	30	30	315			315	
WH18LMKDS	18	M22 x 1.5	4.5	21.0	21.5	45	32	30	315			315	
WH22LMKDS	22	M26 x 1.5	3.5	27.5	24.0	53	41	36	160			160	
WH28LMKDS	28	M33 x 2	3.5	32.0	30.5	66	50	46	160			160	
WH35LMKDS	35	M42 x 2	3.5	36.0	35.5	76	60	55	160			160	
WH42LMKDS	42	M48 x 2	3.5	40.5	40.5	87	70	60	160			160	
WH06SMKDS	6	M12 x 1.5	3.0	16.5	14.0	30	22	19	400			400	
WH08SMKDS	8	M14 x 1.5	3.0	16.5	14.0	30	22	19	400			400	
WH10SMKDS	10	M16 x 1.5	3.0	18.5	16.5	36	27	24	400			400	
WH12SMKDS	12	M18 x 1.5	3.0	20.0	18.5	39.5	27	27	400			400	
WH14SMKDS	14	M20 x 1.5	3.0	22.5	20.0	43.5	32	30	400			400	
WH16SMKDS	16	M22 x 1.5	4.5	22.0	21.5	45	32	30	315			315	
WH20SMKDS	20	M27 x 2	3.5	26.5	24.0	53	41	36	315			315	
WH25SMKDS	25	M33 x 2	3.5	31.5	30.5	66	50	46	250			250	
WH30SMKDS	30	M42 x 2	3.5	37.0	35.5	76	60	55	160			160	
WH38SMKDS	38	M48 x 2	3.5	41.5	40.5	87	70	60	160			160	

For EO-2 part number, insert "Z" between size and pressure series.
Example: WH06ZLMKDSA3C



WAS Full Dimensions

Weld Elbow
24° Flareless / Butt Weld

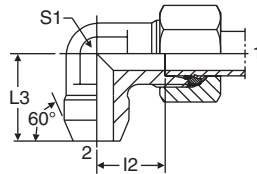

T Full Dimensions

Union Tee
24° Flareless

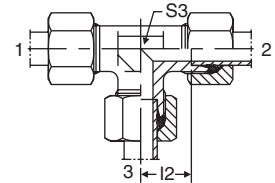

TUBE FITTING PART #	END SIZE		I2 (mm)	L3 (mm)	S3 (mm)	STANDARD Pressure Rating (bar)				
	1 (mm)	2 (mm)				EO		EO-2		
						A3C	71	MS	A3C	71
WAS06L	6	10	12.0	19	12	315			315	
WAS08L	8	12	14.0	23	12	315			315	
WAS10L	10	14	15.0	24	14	315			315	
WAS12L	12	16	17.0	25	17	315			315	
WAS15L	15	19	21.0	30	19	315			315	
WAS18L	18	22	23.5	33	24	315			315	
WAS22L	22	27	27.5	37	27	160			160	
WAS28L	28	32	30.5	42	36	160			160	
WAS35L	35	40	34.5	49	41	160			160	
WAS42L	42	46	40.0	57	50	160			160	
WAS06S	6	11	16.0	23	12	630			630	
WAS08S	8	13	17.0	24	14	630			630	
WAS10S	10	15	17.5	25	17	630			630	
WAS12S	12	17	21.5	29	17	630			630	
WAS14S	14	19	22.0	30	19	630			630	
WAS16S	16	21	24.5	33	24	400			400	
WAS20S	20	26	26.5	37	27	400			400	
WAS25S	25	31	30.0	42	36	400			400	
WAS30S	30	36	35.5	49	41	400			400	
WAS38S	38	44	41.0	57	50	315			315	

Note: Weld fitting. Omit "A3C" in the part number for steel material.
For EO-2 part number, insert "Z" between size and pressure series.
Example: WAS06ZL

TUBE FITTING PART #	END SIZE		I2 (mm)	S3 (mm)	S3 (Only Stainless Steel) (mm)	STANDARD Pressure Rating (bar)				
	1 - 3 (mm)					EO		EO-2		
						A3C	71	MS	A3C	71
* T04LL	4	11.0	9	9	9	100	100	65	100	
* T06LL	6	9.5	11	9	9	100	100	65	100	
* T08LL	8	11.5	12	12	100	100	65			
* T10LL	10	12.5	14	12	100		65			
* T12LL	12	15.0	14	14	100					
* T06L	6	12.0	12	12	315	315	205	315	315	
* T08L	8	14.0	14	12	315	315	205	315	315	
T10L	10	15.0	14	14	315	315	205	315	315	
T12L	12	17.0	17	17	315	315	205	315	315	
T15L	15	21.0	19	19	315	315	205	315	315	
T18L	18	23.5	24	24	315	315	205	315	315	
T22L	22	27.5	27	27	160	160	104	160	160	
T28L	28	30.5	36	36	160	160	104	160	160	
T35L	35	34.5	41	41	160	160	104	160	160	
T42L	42	40.0	50	50	160	160	104	160	160	
* T06S	6	16.0	14	12	630	630	410	630	630	
T08S	8	17.0	14	14	630	630	410	630	630	
T10S	10	17.5	17	17	630	630	410	630	630	
T12S	12	21.5	17	17	630	630	410	630	630	
T14S	14	22.0	19	19	630	630	410	630	630	
T16S	16	24.5	24	24	400	400	260	400	400	
T20S	20	26.5	27	27	400	400	260	400	400	
T25S	25	30.0	36	36	400	400	260	400	400	
T30S	30	35.5	41	41	400	400	260	400	400	
T38S	38	41.0	50	50	315	315	205	315	315	

* Extruded body.
For EO-2 part number, insert "Z" between size and pressure series.
Example: T04ZLLA3C



TR Full Dimensions

Tee-Reducer
24° Flareless

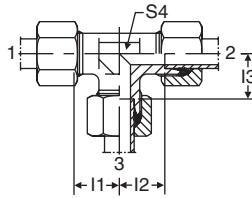

TUBE FITTING PART #	END SIZE			I1 (mm)	I2 (mm)	I3 (mm)	S4 (mm)	STANDARD Pressure Rating (bar)					
	1 (mm)	2 (mm)	3 (mm)					EO			EO-2		
								A3C	71	MS	A3C	71	
TR04/08/04LL	4	8	4	13.0	13.0	11.5	12	100					
TR06/04/06LL	6	4	6	9.5	9.5	11.0	11	100				100	
TR06/08/06L	6	8	6	14.0	14.0	14.0	14	315				315	
TR08/06/08L	8	6	8	14.0	14.0	14.0	14	315				315	
TR06/10/06L	6	10	6	15.0	15.0	15.0	14	315				315	
TR08/10/08L	8	10	8	15.0	15.0	15.0	14	315				315	
TR10/06/10L	10	6	10	15.0	15.0	15.0	14	315				315	
TR10/08/10L	10	8	10	15.0	15.0	15.0	14	315				315	
TR10/10/06L	10	10	6	15.0	15.0	15.0	14	315				315	
TR08/12/08L	8	12	8	17.0	17.0	17.0	17	315				315	
TR12/06/12L	12	6	12	17.0	17.0	17.0	17	315				315	
TR12/08/08L	12	8	8	17.0	17.0	17.0	17	315				315	
TR12/08/12L	12	8	12	17.0	17.0	17.0	17	315				315	
TR12/10/10L	12	10	10	17.0	17.0	17.0	17	315				315	
TR12/10/12L	12	10	12	17.0	17.0	17.0	17	315				315	
TR12/12/10L	12	12	10	17.0	17.0	17.0	17	315				315	
TR10/15/10L	10	15	10	21.0	21.0	21.0	19	315				315	
TR12/15/12L	12	15	12	21.0	21.0	21.0	19	315				315	
TR15/06/15L	15	6	15	21.0	21.0	21.0	19	315				315	
TR15/10/15L	15	10	15	21.0	21.0	21.0	19	315				315	
TR15/12/12L	15	12	12	21.0	21.0	21.0	19	315				315	
TR15/12/15L	15	12	15	21.0	21.0	21.0	19	315				315	
TR15/15/12L	15	15	12	21.0	21.0	21.0	19	315				315	
TR12/18/12L	12	18	12	24.0	24.0	23.5	24	315				315	
TR18/10/10L	18	10	10	23.5	24.0	24.0	24	315				315	
TR18/10/18L	18	10	18	23.5	23.5	24.0	24	315				315	
TR18/12/18L	18	12	18	23.5	23.5	24.0	24	315				315	
TR18/15/18L	18	15	18	23.5	23.5	24.0	24	315				315	
TR18/18/10L	18	18	10	23.5	24.0	23.5	24	315				315	
TR22/10/22L	22	10	22	27.5	27.5	28.0	27	160				160	
TR22/12/22L	22	12	22	27.5	27.5	28.0	27	160				160	
TR22/15/15L	22	15	15	27.5	28.0	28.0	27	160				160	
TR22/15/22L	22	15	22	27.5	27.5	28.0	27	160				160	
TR22/18/18L	22	18	18	27.5	27.5	27.5	27	160				160	
TR22/18/22L	22	18	22	27.5	27.5	27.5	27	160				160	
TR22/22/18L	22	22	18	27.5	27.5	27.5	27	160				160	
TR28/10/28L	28	10	28	30.5	30.5	31.0	36	160				160	
TR28/12/28L	28	12	28	30.5	30.5	31.0	36	160				160	
TR28/15/28L	28	15	28	30.5	30.5	31.0	36	160				160	
TR28/18/28L	28	18	28	30.5	30.5	30.5	36	160				160	
TR28/22/22L	28	22	22	30.5	30.5	30.5	36	160				160	
TR28/22/28L	28	22	28	30.5	30.5	30.5	36	160				160	

Series S is continued on the next page.

For EO-2 part number, insert "Z" between size and pressure series.

Example: TR06/08/06ZLLA3C



TR Full Dimensions

Tee-Reducer
24° Flareless

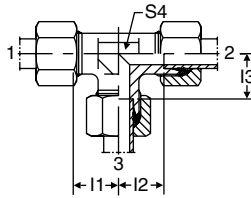

TUBE FITTING PART #	END SIZE			I1 (mm)	I2 (mm)	I3 (mm)	S4 (mm)	STANDARD Pressure Rating (bar)				
	1 (mm)	2 (mm)	3 (mm)					EO			EO-2	
								A3C	71	MS	A3C	71
TR10/06/10S	10	6	10	17.5	17.5	18.0	17	630			630	
TR12/08/08S	12	8	8	21.5	22.0	22.0	17	630			630	
TR12/08/12S	12	8	12	21.5	21.5	22.0	17	630			630	
TR12/10/12S	12	10	12	21.5	21.5	21.5	17	630			630	
TR12/16/12S	12	16	12	25.5	25.5	24.5	24	400			400	
TR16/06/16S	16	6	16	24.5	24.5	26.0	24	400			400	
TR16/08/16S	16	8	16	24.5	24.5	26.0	24	400			400	
TR16/10/16S	16	10	16	24.5	24.5	25.5	24	400			400	
TR16/12/16S	16	12	16	24.5	24.5	25.5	24	400			400	
TR16/20/16S	16	20	16	28.5	28.5	26.5	27	400			400	
TR20/10/20S	20	10	20	26.5	26.5	29.5	27	400			400	
TR20/12/20S	20	12	20	26.5	26.5	29.5	27	400			400	
TR20/16/20S	20	16	20	26.5	26.5	28.5	27	400			400	
TR20/25/20S	20	25	20	31.5	31.5	30.0	36	400			400	
TR25/16/25S	25	16	25	30.0	30.0	33.5	36	400			400	
TR25/20/25S	25	20	25	30.0	30.0	31.5	36	400			400	
TR25/30/25S	25	30	25	37.0	37.0	35.5	41	400			400	

Series L is on the previous page.

For EO-2 part number, insert "Z" between size and pressure series.

Example: TR10/06/10ZSA3C

TEE-UNF Full Dimensions

Adjustable Locknut Branch Tee
24° Flareless / SAE-ORB

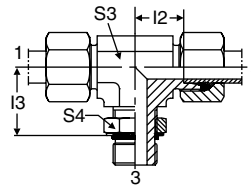

TUBE FITTING PART #	END SIZE		I2 (mm)	I3 (mm)	S3 (mm)	STANDARD Pressure Rating (bar)				
	1 & 2 (mm)	3 UN/UNF-2A				EO			EO-2	
						A3C	71	MS	A3C	71
TEE06L7/16UNF	6	7/16-20	14	19	14	315			315	
TEE08L7/16UNF	8	7/16-20	16	19	14	315			315	
TEE10L9/16UNF	10	9/16-18	17	24	19	315			315	
TEE12L9/16UNF	12	9/16-18	19	25	19	315			315	
TEE12L3/4UNF	12	3/4-16	19	25	19	315			315	
TEE15L3/4UNF	15	3/4-16	21	28	22	315			315	
TEE15L7/8UNF	15	7/8-14	21	28	22	315			315	
TEE18L7/8UNF	18	7/8-14	24	32	27	315			315	
TEE18L11/16UN	18	1 1/16-12	24	32	30	315			315	
TEE22L11/16UN	22	1 1/16-12	28	35	30	160			160	
TEE28L15/16UN	28	1 5/16-12	31	42	36	160			160	
TEE35L15/8UN	35	1 5/8-12	38	46	50	160			160	
TEE42L17/8UN	42	1 7/8-12	38	47	50	160			160	
TEE06S7/16UNF	6	7/16-20	15	20	14	400			400	
TEE08S9/16UNF	8	9/16-18	17	25	19	400			400	
TEE10S9/16UNF	10	9/16-18	18	26	19	400			400	
TEE12S3/4UNF	12	3/4-16	22	30	22	400			400	
TEE16S7/8UNF	16	7/8-14	25	34	27	400			400	
TEE20S11/16UN	20	1 1/16-12	28	37	30	400			400	
TEE25S11/16UN	25	1 1/16-12	30	50	36	400			400	
TEE30S15/8UN	30	1 5/8-12	36	50	50	250			250	
TEE38S17/8UN	38	1 7/8-12	34	51	50	250			250	

For EO-2 part number, insert "Z" between size and pressure series.

Example: TEE06ZL7/16UNFA3C



TEE-OR Full Dimensions

Adjustable Locknut Branch Tee
24° Flareless / Metric ISO 6149

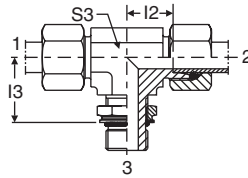

TUBE FITTING PART #	END SIZE		I2 (mm)	I3 (mm)	S3 (mm)	STANDARD Pressure Rating (bar)				
	1 (mm)	2 Metric				EO			EO-2	
						A3C	71	MS	A3C	71
TEE06LMOR	6	M10 x 1	14	20	14	315			315	
TEE08LMOR	8	M12 x 1.5	16	22	14	315			315	
TEE10LMOR	10	M14 x 1.5	17	25	19	315			315	
TEE12LMOR	12	M16 x 1.5	19	26	19	315			315	
TEE15LMOR	15	M18 x 1.5	21	30	22	315			315	
TEE18LMOR	18	M22 x 1.5	24	33	27	315			315	
TEE22LM27X2OR	22	M27 x 2	28	35	30	160			160	
TEE28LMOR	28	M33 x 2	31	38	36	160			160	
TEE35LMOR	35	M42 x 2	38	48	50	160			160	
TEE42LMOR	42	M48 x 2	38	49	50	160			160	
TEE06SMOR	6	M12 x 1.5	15	22	14	400			400	
TEE08SMOR	8	M14 x 1.5	17	26	19	400			400	
TEE10SMOR	10	M16 x 1.5	18	27	19	400			400	
TEE12SMOR	12	M18 x 1.5	22	31	22	400			400	
TEE16SMOR	16	M22 x 1.5	25	35	27	400			400	
TEE20SMOR	20	M27 x 2	28	39	30	400			400	
TEE25SMOR	25	M33 x 2	30	44	36	315			315	
TEE30SMOR	30	M42 x 2	36	51	50	250			250	
TEE38SMOR	38	M48 x 2	34	54	50	200			200	

For EO-2 part number, insert "Z" between size and pressure series.
Example: TR06ZLMORA3C

TEE-R Full Dimensions

Adjustable Locknut Branch Tee
24° Flareless / BSPP ORR

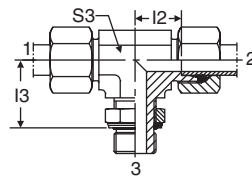

TUBE FITTING PART #	END SIZE		I2 (mm)	I3 (mm)	S3 (mm)	STANDARD Pressure Rating (bar)				
	1 & 2 (mm)	3 BSPP				EO			EO-2	
						A3C	71	MS	A3C	71
TEE06LR	6	G 1/8A	14	19	14	315			315	
TEE08LR	8	G 1/4A	16	23	14	315			315	
TEE10LR	10	G 1/4A	17	25	19	315			315	
TEE12LR	12	G 3/8A	19	28	19	250			250	
TEE15LR	15	G 1/2A	21	30	22	250			250	
TEE18LR	18	G 1/2A	24	36	27	250			250	
TEE22LR	22	G 3/4A	28	36	30	160			160	
TEE28LR	28	G 1A	31	44	36	160			160	
TEE35LR	35	G 1 1/4A	38	50	50	160			160	
TEE42LR	42	G 1 1/2A	38	52	50	160			160	
TEE06SR	6	G 1/4A	15	23	14	315			315	
TEE08SR	8	G 1/4A	17	27	19	315			315	
TEE10SR	10	G 3/8A	18	29	19	250			250	
TEE12SR	12	G 3/8A	22	29	22	250			250	
TEE16SR	16	G 1/2A	25	36	27	250			250	
TEE20SR	20	G 3/4A	28	39	30	250			250	
TEE25SR	25	G 1A	30	44	36	250			250	
TEE30SR	30	G 1 1/4A	36	49	50	160			160	
TEE38SR	38	G 1 1/2A	34	55	50	160			160	

For EO-2 part number, insert "Z" between size and pressure series.
Example: TEE06ZLRA3C



TEE-M Full Dimensions

Adjustable Locknut Branch Tee
24° Flareless / Metric ORR

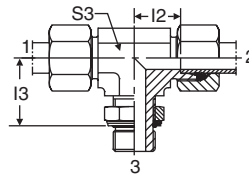

TUBE FITTING PART #	END SIZE		I2 (mm)	I3 (mm)	S3 (mm)	STANDARD Pressure Rating (bar)				
	1 & 2 (mm)	3 Metric				EO			EO-2	
						A3C	71	MS	A3C	71
TEE06LM	6	M10 x 1	14	20	14	315			315	
TEE08LM	8	M12 x 1.5	16	22	14	315			315	
TEE10LM	10	M14 x 1.5	17	25	19	315			315	
TEE12LM	12	M16 x 1.5	19	26	19	315			315	
TEE15LM	15	M18 x 1.5	21	30	22	315			315	
TEE18LM	18	M22 x 1.5	24	33	27	250			250	
TEE22LM27X2	22	M27 x 2	28	35	30	160			160	
TEE28LM	28	M33 x 2	31	38	36	160			160	
TEE35LM	35	M42 x 2	38	48	50	160			160	
TEE42LM	42	M48 x 2	38	49	50	160			160	
TEE06SM	6	M12 x 1.5	15	22	14	315			315	
TEE08SM	8	M14 x 1.5	17	26	19	315			315	
TEE10SM	10	M16 x 1.5	18	27	19	315			315	
TEE12SM	12	M18 x 1.5	22	31	22	315			315	
TEE16SM	16	M22 x 1.5	25	35	27	250			250	
TEE20SM	20	M27 x 2	28	39	30	250			250	
TEE25SM	25	M33 x 2	30	44	36	160			160	
TEE30SM	30	M42 x 2	36	51	50	160			160	
TEE38SM	38	M48 x 2	34	54	50	160			160	

For EO-2 part number, insert "Z" between size and pressure series.
Example: TEE06ZLMA3C

LEE-UNF Full Dimensions

Adjustable Locknut Run Tee
24° Flareless / SAE-ORB

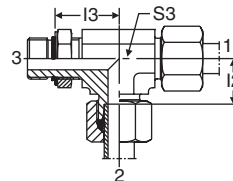

TUBE FITTING PART #	END SIZE		I2 (mm)	I3 (mm)	S3 (mm)	STANDARD Pressure Rating (bar)				
	1 & 2 (mm)	3 UN/UNF-2A				EO			EO-2	
						A3C	71	MS	A3C	71
LEE06L7/16UNF	6	7/16-20	14	19	14	315			315	
LEE08L7/16UNF	8	7/16-20	16	19	14	315			315	
LEE10L9/16UNF	10	9/16-18	17	24	19	315			315	
LEE12L9/16UNF	12	9/16-18	19	25	19	315			315	
LEE12L3/4UNF	12	3/4-16	19	25	19	315			315	
LEE15L3/4UNF	15	3/4-16	21	28	22	315			315	
LEE15L7/8UNF	15	7/8-14	21	28	22	315			315	
LEE18L7/8UNF	18	7/8-14	24	32	27	315			315	
LEE18L11/16UN	18	1 1/16-12	24	32	30	315			315	
LEE22L11/16UN	22	1 1/16-12	28	35	30	160			160	
LEE28L15/16UN	28	1 5/16-12	31	42	36	160			160	
LEE35L15/8UN	35	1 5/8-12	38	46	50	160			160	
LEE42L17/8UN	42	1 7/8-12	38	47	50	160			160	
LEE06S7/16UNF	6	7/16-20	15	20	14	400			400	
LEE08S9/16UNF	8	9/16-18	17	25	19	400			400	
LEE10S9/16UNF	10	9/16-18	18	26	19	400			400	
LEE12S3/4UNF	12	3/4-16	22	30	22	400			400	
LEE16S7/8UNF	16	7/8-14	25	34	27	400			400	
LEE20S11/16UN	20	1 1/16-12	28	37	30	400			400	
LEE25S11/16UN	25	1 1/16-12	30	50	36	400			400	
LEE30S15/8UN	30	1 5/8-12	36	50	50	250			250	
LEE38S17/8UN	38	1 7/8-12	34	51	50	250			250	

For EO-2 part number, insert "Z" between size and pressure series.
Example: LEE06ZL7/16UNFA3C



LEE-OR Full Dimensions

Adjustable Locknut Run Tee
24° Flareless / Metric ISO 6149

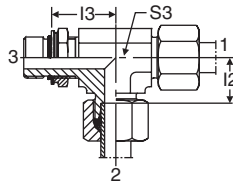

TUBE FITTING PART #	END SIZE		I 2 (mm)	I 3 (mm)	S3 (mm)	STANDARD Pressure Rating (bar)				
	1 & 2 (mm)	3 Metric				EO			EO-2	
						A3C	71	MS	A3C	71
LEE06LMOR	6	M10 x 1	14	20	14	315			315	
LEE08LMOR	8	M12 x 1.5	16	22	14	315			315	
LEE10LMOR	10	M14 x 1.5	17	25	19	315			315	
LEE12LMOR	12	M16 x 1.5	19	26	19	315			315	
LEE15LMOR	15	M18 x 1.5	21	30	22	315			315	
LEE18LMOR	18	M22 x 1.5	24	33	27	315			315	
LEE22LM27x2OR	22	M27 x 2	28	25	30	160			160	
LEE28LMOR	28	M33 x 2	31	38	36	160			160	
LEE35LMOR	35	M42 x 2	38	48	50	160			160	
LEE42LMOR	42	M48 x 2	38	49	50	160			160	
LEE06SMOR	6	M12 x 1.5	15	22	14	400			400	
LEE08SMOR	8	M14 x 1.5	17	26	19	400			400	
LEE10SMOR	10	M16 x 1.5	18	27	19	400			400	
LEE12SMOR	12	M18 x 1.5	22	31	22	400			400	
LEE16SMOR	16	M22 x 1.5	25	35	27	400			400	
LEE20SMOR	20	M27 x 2	28	35	30	400			400	
LEE25SMOR	25	M33 x 2	30	44	36	315			315	
LEE30SMOR	30	M42 x 2	36	51	50	250			250	
LEE38SMOR	38	M48 x 2	34	54	50	200			200	

For EO-2 part number, insert "Z" between size and pressure series.
Example: LEE06ZLMORA3C

LEE-R Full Dimensions

Adjustable Locknut Run Tee
24° Flareless / BSPP ORR

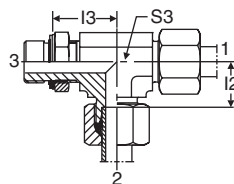

TUBE FITTING PART #	END SIZE		I 2 (mm)	I 3 (mm)	S3 (mm)	STANDARD Pressure Rating (bar)				
	1 & 2 (mm)	3 BSPP				EO			EO-2	
						A3C	71	MS	A3C	71
LEE06LR	6	G 1/8A	14	19	14	315			315	
LEE08LR	8	G 1/4A	16	23	14	315			315	
LEE10LR	10	G 1/4A	17	25	19	315			315	
LEE12LR	12	G 3/8A	19	28	19	250			250	
LEE15LR	15	G 1/2A	21	30	22	250			250	
LEE18LR	18	G 1/2A	24	36	27	250			250	
LEE22LR	22	G 3/4A	28	36	30	160			160	
LEE28LR	28	G 1A	31	44	36	160			160	
LEE35LR	35	G 1 1/4A	38	50	50	160			160	
LEE42LR	42	G 1 1/2A	38	52	50	160			160	
LEE06SR	6	G 1/4A	15	23	14	315			315	
LEE08SR	8	G 1/4A	17	27	19	315			315	
LEE10SR	10	G 3/8A	18	29	19	250			250	
LEE12SR	12	G 3/8A	22	29	22	250			250	
LEE16SR	16	G 1/2A	25	36	27	250			250	
LEE20SR	20	G 3/4A	28	39	30	250			250	
LEE25SR	25	G 1A	30	44	36	250			250	
LEE30SR	30	G 1 1/4A	36	49	50	160			160	
LEE38SR	38	G 1 1/2A	34	55	50	160			160	

For EO-2 part number, insert "Z" between size and pressure series.
Example: LEE06ZLRA3C

LEE-M Full Dimensions

Adjustable Locknut Run Tee
24° Flareless / Metric ORR

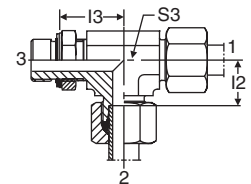

TUBE FITTING PART #	END SIZE		I 2 (mm)	I 3 (mm)	S3 (mm)	STANDARD Pressure Rating (bar)				
	1 & 2 (mm)	3 Metric				EO			EO-2	
						A3C	71	MS	A3C	71
LEE06LM	6	M10 x 1	14	8	14	315			315	
LEE08LM	8	M12 x 1.5	16	8	14	315			315	
LEE10LM	10	M14 x 1.5	17	11	19	315			315	
LEE12LM	12	M16 x 1.5	19	14	19	315			315	
LEE15LM	15	M18 x 1.5	21	14	22	315			315	
LEE18LM	18	M22 x 1.5	24	17	27	250			250	
LEE22LM27X2	22	M27 x 2	28	19	30	160			160	
LEE28LM	28	M33 x 2	31	27	36	160			160	
LEE35LM	35	M42 x 2	38	37	50	160			160	
LEE42LM	42	M48 x 2	38	40	50	160			160	
LEE06SM	6	M12 x 1.5	15	8	14	315			315	
LEE08SM	8	M14 x 1.5	17	10	19	315			315	
LEE10SM	10	M16 x 1.5	18	12	19	315			315	
LEE12SM	12	M18 x 1.5	22	13	22	315			315	
LEE16SM	16	M22 x 1.5	25	14	27	250			250	
LEE20SM	20	M27 x 2	28	17	30	250			250	
LEE25SM	25	M33 x 2	30	25	36	160			160	
LEE30SM	30	M42 x 2	36	34	50	160			160	
LEE38SM	38	M48 x 2	34	37	50	160			160	

For EO-2 part number, insert "Z" between size and pressure series.
Example: LEE06ZLMA3C



ET Full Dimensions

Swivel Nut Branch Tee
 24° Flareless / 24° Flareless /
 Flareless Swivel

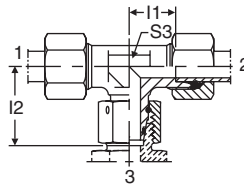

TUBE FITTING PART #	END SIZE		I1 (mm)	I2 (mm)	S3 (mm)	STANDARD Pressure Rating (bar)				
	1 & 2 (mm)	3 Metric				EO			EO-2	
						A3C	71	MS	A3C	71
ET06L	6	M12 x 1.5	12.0	26.0	12	315	315		315	315
ET08L	8	M14 x 1.5	14.0	27.5	12	315	315		315	315
ET10L	10	M16 x 1.5	15.0	29.0	14	315	315		315	315
ET12L	12	M18 x 1.5	17.0	29.5	17	315	315		315	315
ET15L	15	M22 x 1.5	21.0	32.5	19	315	315		315	315
ET18L	18	M26 x 1.5	23.5	35.5	24	315	315		315	315
ET22L	22	M30 x 2	27.5	38.5	27	160	160		160	160
ET28L	28	M36 x 2	30.5	41.5	36	160	160		160	160
ET35L	35	M45 x 2	34.5	51.0	41	160	160		160	160
ET42L	42	M52 x 2	40.0	56.0	50	160	160		160	160
ET06S	6	M14 x 1.5	16.0	27.0	12	630	630		630	630
ET08S	8	M16 x 1.5	17.0	27.5	14	630	630		630	630
ET10S	10	M18 x 1.5	17.5	30.0	17	630	630		630	630
ET12S	12	M20 x 1.5	21.5	31.0	17	630	630		630	630
ET14S	14	M22 x 1.5	22.0	35.0	19	630	630		630	630
ET16S	16	M24 x 1.5	24.5	36.5	24	400	400		400	400
ET20S	20	M30 x 2	26.5	44.5	27	400	400		400	400
ET25S	25	M36 x 2	30.0	50.0	36	400	400		400	400
ET30S	30	M42 x 2	35.5	55.0	41	400	400		400	400
ET38S	38	M52 x 2	41.0	63.0	50	315	315		315	315

For EO-2 part number, insert "Z" between size and pressure series.
 Example: ET06ZLA3C

ET-R-ED Full Dimensions

Assembled Adjustable Swivel Branch Tee
 24° Flareless / 24° Flareless /
 BSPP with EOlastic Seal

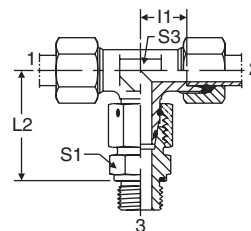

TUBE FITTING PART #	END SIZE		I1 (mm)	L2 (mm)	S1 (mm)	S3 (mm)	STANDARD Pressure Rating (bar)					
	1 & 2 (mm)	3 BSPP					EO			EO-2		
							A3C	71	MS	A3C	71	
ET06LRED	6	G 1/8 A	12.0	34.5	14	12	315				315	
ET08LRED	8	G 1/4 A	14.0	37.5	19	12	315				315	
ET10LRED	10	G 1/4 A	15.0	40.0	19	14	315				315	
ET12LRED	12	G 3/8 A	17.0	42.0	22	17	315				315	
ET15LRED	15	G 1/2 A	21.0	46.5	27	19	315				315	
ET18LRED	18	G 1/2 A	23.5	50.0	27	24	315				315	
ET22LRED	22	G 3/4 A	27.5	55.0	32	27	160				160	
ET28LRED	28	G 1 A	30.5	59.0	41	36	160				160	
ET35LRED	35	G 1 1/4 A	34.5	68.5	50	41	160				160	
ET42LRED	42	G 1 1/2 A	40.0	75.0	55	50	160				160	
ET06SRED	6	G 1/4 A	16.0	40.0	19	12	630				630	
ET08SRED	8	G 1/4 A	17.0	42.5	19	14	630				630	
ET10SRED	10	G 3/8 A	17.5	45.0	22	17	630				630	
ET12SRED	12	G 3/8 A	21.5	48.0	22	17	630				630	
ET14SRED	14	G 1/2 A	22.0	54.0	27	19	630				630	
ET16SRED	16	G 1/2 A	24.5	55.0	27	24	400				400	
ET20SRED	20	G 3/4 A	26.5	65.0	32	27	400				400	
ET25SRED	25	G 1 A	30.0	73.0	41	36	400				400	
ET30SRED	30	G 1 1/4 A	35.5	78.5	50	41	400				400	
ET38SRED	38	G 1 1/2 A	41.0	89.0	55	50	315				315	

For EO-2 part number, insert "Z" between size and pressure series.
 Example: ET06ZLREDA3C



ET-M-ED Full Dimensions

Assembled Adjustable Swivel Branch Tee
 24° Flareless / 24° Flareless /
 Metric Parallel with EOlastic Seal

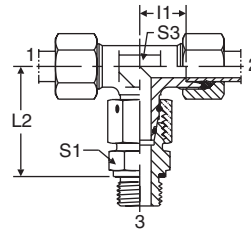

TUBE FITTING PART #	END SIZE		I1 (mm)	L2 (mm)	S1 (mm)	S3 (mm)	STANDARD Pressure Rating (bar)					
	1 & 2 (mm)	3 Metric					EO			EO-2		
							A3C	71	MS	A3C	71	
ET06LMED	6	M10 x 1	12.0	34.5	14	12	315				315	
ET08LMED	8	M12 x 1.5	14.0	37.5	17	12	315				315	
ET10LMED	10	M14 x 1.5	15.0	40.0	19	14	315				315	
ET12LMED	12	M16 x 1.5	17.0	42.0	22	17	315				315	
ET15LMED	15	M18 x 1.5	21.0	46.0	24	19	315				315	
ET18LMED	18	M22 x 1.5	23.5	50.0	27	24	315				315	
ET22LMED	22	M26 x 1.5	27.5	55.0	32	27	160				160	
ET28LMED	28	M33 x 2	30.5	59.0	41	36	160				160	
ET35LMED	35	M42 x 2	34.5	68.5	50	41	160				160	
ET42LMED	42	M48 x 2	40.0	75.0	55	50	160				160	
ET06SMED	6	M12 x 1.5	16.0	40.0	17	12	630				630	
ET08SMED	8	M14 x 1.5	17.0	42.5	19	14	630				630	
ET10SMED	10	M16 x 1.5	17.5	45.0	22	17	630				630	
ET12SMED	12	M18 x 1.5	21.5	48.0	24	17	630				630	
ET14SMED	14	M20 x 1.5	22.0	54.0	27	19	630				630	
ET16SMED	16	M22 x 1.5	24.5	55.0	27	24	400				400	
ET20SMED	20	M27 x 2	26.5	65.0	32	27	400				400	
ET25SMED	25	M33 x 2	30.0	73.0	41	36	400				400	
ET30SMED	30	M42 x 2	35.5	78.5	50	41	400				400	
ET38SMED	38	M48 x 2	41.0	89.0	55	50	315				315	

For EO-2 part number, insert "Z" between size and pressure series.
 Example: ET06ZLMEDA3C

EL Full Dimensions

Swivel Nut Run Tee
 24° Flareless / Flareless Swivel

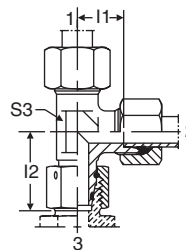

TUBE FITTING PART #	END SIZE		I1 (mm)	I2 (mm)	S3 (mm)	STANDARD Pressure Rating (bar)				
	1 & 2 (mm)	3 Metric				EO			EO-2	
						A3C	71	MS	A3C	71
EL06L	6	M12 x 1.5	12.0	26.0	12	315	315		315	315
EL08L	8	M14 x 1.5	14.0	27.5	12	315	315		315	315
EL10L	10	M16 x 1.5	15.0	29.0	14	315	315		315	315
EL12L	12	M18 x 1.5	17.0	29.5	17	315	315		315	315
EL15L	15	M22 x 1.5	21.0	32.5	19	315	315		315	315
EL18L	18	M26 x 1.5	23.5	35.5	24	315	315		315	315
EL22L	22	M30 x 2	27.5	38.5	27	160	160		160	160
EL28L	28	M36 x 2	30.5	41.5	36	160	160		160	160
EL35L	35	M45 x 2	34.5	51.0	41	160	160		160	160
EL42L	42	M52 x 2	40.0	56.0	50	160	160		160	160
EL06S	6	M14 x 1.5	16.0	27.0	12	630	630		630	630
EL08S	8	M16 x 1.5	17.0	27.5	14	630	630		630	630
EL10S	10	M18 x 1.5	17.5	30.0	17	630	630		630	630
EL12S	12	M20 x 1.5	21.5	31.0	17	630	630		630	630
EL14S	14	M22 x 1.5	22.0	35.0	19	630	630		630	630
EL16S	16	M24 x 1.5	24.5	36.5	24	400	400		400	400
EL20S	20	M30 x 2	26.5	44.5	27	400	400		400	400
EL25S	25	M36 x 2	30.0	50.0	36	400	400		400	400
EL30S	30	M42 x 2	35.5	55.0	41	400	400		400	400
EL38S	38	M52 x 2	41.0	63.0	50	315	315		315	315

For EO-2 part number, insert "Z" between size and pressure series.
 Example: EL06ZLA3C



EL-R-ED Full Dimensions

Adjustable Assembled Swivel Run Tee
24° Flareless / BSPP with EOlastic Seal

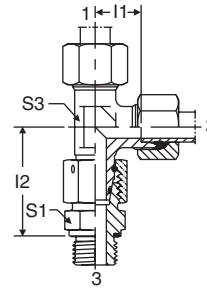

TUBE FITTING PART #	END SIZE		I1 (mm)	I2 (mm)	L3 (mm)	S1 (mm)	S3 (mm)	STANDARD Pressure Rating (bar)				
	1 & 2 (mm)	3 BSPP						EO			EO-2	
								A3C	71	MS	A3C	71
EL06LR	6	G 1/8 A	12.0	34.5	61	14	12	315			315	
EL08LR	8	G 1/4 A	14.0	37.5	66	17	12	315			315	
EL10LR	10	G 1/4 A	15.0	40.0	70	19	14	315			315	
EL12LR	12	G 3/8 A	17.0	42.0	75	22	17	315			315	
EL15LR	15	G 1/2 A	21.0	46.5	84	24	19	315			315	
EL18LR	18	G 1/2 A	23.5	50.0	90	27	24	315			315	
EL22LR	22	G 3/4 A	27.5	55.0	99	32	27	160			160	
EL28LR	28	G 1 A	30.5	59.0	108	41	36	160			160	
EL35LR	35	G 1 1/4 A	34.5	68.5	128	50	41	160			160	
EL42LR	42	G 1 1/2 A	40.0	75.0	142	55	50	160			160	
EL06SR	6	G 1/4 A	16.0	40.0	71	17	12	630			630	
EL08SR	8	G 1/4 A	17.0	42.5	76	19	14	630			630	
EL10SR	10	G 3/8 A	17.5	45.0	81	22	17	630			630	
EL12SR	12	G 3/8 A	21.5	48.0	88	24	17	630			630	
EL14SR	14	G 1/2 A	22.0	54.0	95	27	19	630			630	
EL16SR	16	G 1/2 A	24.5	55.0	99	27	24	400			400	
EL20SR	20	G 3/4 A	26.5	65.0	113	32	27	400			400	
EL25SR	25	G 1 A	30.0	73.0	128	41	36	400			400	
EL30SR	30	G 1 1/4 A	35.5	78.5	142	50	41	400			400	
EL38SR	38	G 1 1/2 A	41.0	89.0	165	55	50	315			315	

For EO-2 part number, insert "Z" between size and pressure series.
Example: EL06ZLRDA3C

EL-M-ED Full Dimensions

Adjustable Assembled Swivel Run Tee
24° Flareless / Metric Parallel with EOlastic Seal

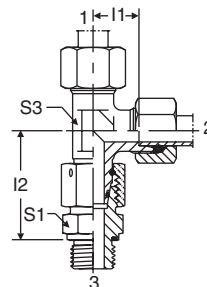

TUBE FITTING PART #	END SIZE		I1 (mm)	I2 (mm)	S1 (mm)	S3 (mm)	STANDARD Pressure Rating (bar)				
	1 & 2 (mm)	3 Metric					EO			EO-2	
							A3C	71	MS	A3C	71
EL06LM	6	M10 x 1	12.0	34.5	14	12	315			315	
EL08LM	8	M12 x 1.5	14.0	37.5	17	12	315			315	
EL10LM	10	M14 x 1.5	15.0	40.0	19	14	315			315	
EL12LM	12	M16 x 1.5	17.0	42.0	22	17	315			315	
EL15LM	15	M18 x 1.5	21.0	46.5	24	19	315			315	
EL18LM	18	M22 x 1.5	23.5	50.0	27	24	315			315	
EL22LM	22	M26 x 1.5	27.5	55.0	32	27	160			160	
EL28LM	28	M33 x 2	30.5	59.0	41	36	160			160	
EL35LM	35	M42 x 2	34.5	68.5	50	41	160			160	
EL42LM	42	M48 x 2	40.0	75.0	55	50	160			160	
EL06SM	6	M12 x 1.5	16.0	40.0	17	12	630			630	
EL08SM	8	M14 x 1.5	17.0	42.5	19	14	630			630	
EL10SM	10	M16 x 1.5	17.5	45.0	22	17	630			630	
EL12SM	12	M18 x 1.5	21.5	48.0	24	17	630			630	
EL14SM	14	M20 x 1.5	22.0	54.0	27	19	630			630	
EL16SM	16	M22 x 1.5	24.5	55.0	27	24	400			400	
EL20SM	20	M27 x 2	26.5	65.0	32	27	400			400	
EL25SM	25	M33 x 2	30.0	73.0	41	36	400			400	
EL30SM	30	M42 x 2	35.5	78.5	50	41	400			400	
EL38SM	38	M48 x 2	41.0	89.0	55	50	315			315	

For EO-2 part number, insert "Z" between size and pressure series.
Example: EL06ZLMEDA3C



TH-R Full Dimensions

High Pressure Banjo Tee
24° Flareless / 24° Flareless / BSPP

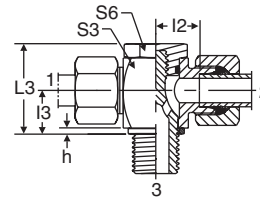

TUBE FITTING PART #	END SIZE		h (mm)	I2 (mm)	I3 (mm)	L3 (mm)	S3 (mm)	S6 (mm)	STANDARD Pressure Rating (bar)				
	1 & 2 (mm)	3 BSPP							EO			EO-2	
									A3C	71	MS	A3C	71
TH06LR	6	G 1/8 A	2.5	12.0	10.5	24	17	17	250	250			250
TH08LR	8	G 1/4 A	3.0	14.5	14.0	30	22	19	250	250			250
TH10LR	10	G 1/4 A	3.0	15.5	14.0	30	22	19	250	250			250
TH12LR	12	G 3/8 A	3.0	18.0	16.5	36	27	24	250	250			250
TH15LR	15	G 1/2 A	4.5	21.5	21.5	45	32	30	250	250			250
TH18LR	18	G 1/2 A	4.5	21.0	21.5	45	32	30	250	250			250
TH22LR	22	G 3/4 A	3.5	27.5	24.0	53	41	36	160	160			160
TH28LR	28	G 1 A	3.5	32.0	30.5	66	50	46	160	160			160
TH35LR	35	G 1 1/4 A	3.5	36.0	35.5	76	60	55	200				
TH42LR	42	G 1 1/2 A	3.5	40.5	40.5	87	70	60	200				
TH06SR	6	G 1/4 A	3.0	16.5	14.0	30	22	19	400	400			400
TH08SR	8	G 1/4 A	3.0	16.5	14.0	30	22	19	400	400			400
TH10SR	10	G 3/8 A	3.0	18.5	16.5	36	27	24	400	400			400
TH12SR	12	G 3/8 A	3.0	18.5	16.5	36	27	24	400	400			400
TH14SR	14	G 1/2 A	4.5	22.5	21.5	45	32	30	400				400
TH16SR	16	G 1/2 A	4.5	22.0	21.5	45	32	30	400	400			400
TH20SR	20	G 3/4 A	3.5	26.5	24.0	53	41	36	160	160			160
TH25SR	25	G 1 A	3.5	31.5	30.5	66	50	46	160	160			160
TH30SR	30	G 1 1/4 A	3.5	37.0	35.5	76	60	55	160				
TH38SR	38	G 1 1/2 A	3.5	41.5	40.5	87	70	60	160				

For EO-2 part number, insert "Z" between size and pressure series.
Example: TH06ZLRA3C

TH-M Full Dimensions

High Pressure Banjo Tee
24° Flareless / 24° Flareless / Metric Parallel

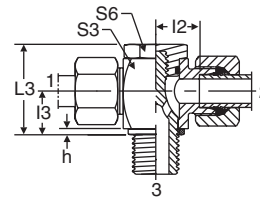

TUBE FITTING PART #	END SIZE		h (mm)	I2 (mm)	I3 (mm)	L3 (mm)	S3 (mm)	S6 (mm)	STANDARD Pressure Rating (bar)				
	1 & 2 (mm)	3 Metric							EO			EO-2	
									A3C	71	MS	A3C	71
TH06LM	6	M10 x 1	2.5	12.0	10.5	24.0	17	17	250	250			250
TH08LM	8	M12 x 1.5	3.0	14.5	14.0	30.0	22	19	250	250			250
TH10LM	10	M14 x 1.5	3.0	15.5	14.0	30.0	22	19	250	250			250
TH12LM	12	M16 x 1.5	3.0	18.0	16.5	36.0	27	24	250	250			250
TH15LM	15	M18 x 1.5	3.0	21.5	18.5	39.5	30	30	250	250			250
TH18LM	18	M22 x 1.5	4.5	21.0	21.5	45.0	32	30	250	250			250
TH22LM	22	M26 x 1.5	3.5	27.5	24.0	53.0	41	36	160	160			160
TH28LM	28	M33 x 2	3.5	32.0	30.5	66.0	50	46	160	160			160
TH35LM	35	M42 x 2	3.5	36.0	35.5	76.0	60	55	160				
TH42LM	42	M48 x 2	3.5	40.5	40.5	87.0	70	60	160				
TH06SM	6	M12 x 1.5	3.0	16.5	14.0	30.0	22	19	400	400			400
TH08SM	8	M14 x 1.5	3.0	16.5	14.0	30.0	22	19	400	400			400
TH10SM	10	M16 x 1.5	3.0	18.5	16.5	36.0	27	24	400	400			400
TH12SM	12	M18 x 1.5	3.0	20.0	18.5	39.5	27	27	400	400			400
TH14SM	14	M20 x 1.5	3.0	22.5	20.0	43.5	32	30	400	400			400
TH16SM	16	M22 x 1.5	4.5	22.0	21.5	45.0	32	30	400	400			400
TH20SM	20	M27 x 2	3.5	26.5	24.0	53.0	41	36	160	160			160
TH25SM	25	M33 x 2	3.5	31.5	30.5	66.0	50	46	160	160			160
TH30SM	30	M42 x 2	3.5	37.0	35.5	76.0	60	55	160				
TH38SM	38	M48 x 2	3.5	41.5	40.5	87.0	70	60	160				

For EO-2 part number, insert "Z" between size and pressure series.
Example: TH06ZLMA3C



TH-R-KDS Full Dimensions

High Pressure Banjo Tee
24° Flareless / 24° Flareless / BSPP

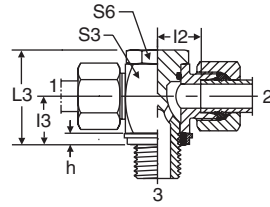

TUBE FITTING PART #	END SIZE		h (mm)	I2 (mm)	I3 (mm)	L3 (mm)	S3 (mm)	S6 (mm)	STANDARD Pressure Rating (bar)				
	1 & 2 (mm)	3 BSPP							EO			EO-2	
									A3C	71	MS	A3C	71
TH06LRKDS	6	G 1/8 A	2.5	12.0	10.5	24	17	17	315	315		315	315
TH08LRKDS	8	G 1/4 A	3.0	14.5	14.0	30	22	19	315	315		315	315
TH10LRKDS	10	G 1/4 A	3.0	15.5	14.0	30	22	19	315	315		315	315
TH12LRKDS	12	G 3/8 A	3.0	18.0	16.5	36	27	24	315	315		315	315
TH15LRKDS	15	G 1/2 A	4.5	21.5	21.5	45	32	30	315	315		315	315
TH18LRKDS	18	G 1/2 A	4.5	21.0	21.5	45	32	30	315	315		315	315
TH22LRKDS	22	G 3/4 A	3.5	27.5	24.0	53	41	36	160	160		160	160
TH28LRKDS	28	G 1 A	3.5	32.0	30.5	66	50	46	160	160		160	160
TH35LRKDS	35	G 1 1/4 A	3.5	36.0	35.5	76	60	55	160			160	
TH42LRKDS	42	G 1 1/2 A	3.5	40.5	40.5	87	70	60	160			160	
TH06SRKDS	6	G 1/4 A	3.0	16.5	14.0	30	22	19	400	400		400	400
TH08SRKDS	8	G 1/4 A	3.0	16.5	14.0	30	22	19	400	400		400	400
TH10SRKDS	10	G 3/8 A	3.0	18.5	16.5	36	27	24	400	400		400	400
TH12SRKDS	12	G 3/8 A	3.0	18.5	16.5	36	27	24	400	400		400	400
TH14SRKDS	14	G 1/2 A	4.5	22.5	21.5	45	32	30					
TH16SRKDS	16	G 1/2 A	4.5	22.0	21.5	45	32	30	315	315		315	315
TH20SRKDS	20	G 3/4 A	3.5	26.5	24.0	53	41	36	315	315		315	315
TH25SRKDS	25	G 1 A	3.5	31.5	30.5	66	50	46	250	250		250	250
TH30SRKDS	30	G 1 1/4 A	3.5	37.0	34.5	76	60	55	160			160	
TH38SRKDS	38	G 1 1/2 A	3.5	41.5	40.5	87	70	60	160			160	

For EO-2 part number, insert "Z" between size and pressure series.
Example: TH06ZLRKDSA3C

TH-M-KDS Full Dimensions

High Pressure Banjo Tee
24° Flareless / 24° Flareless / Metric Parallel

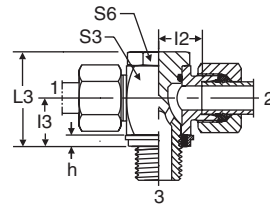

TUBE FITTING PART #	END SIZE		h (mm)	I2 (mm)	I3 (mm)	L3 (mm)	S3 (mm)	S6 (mm)	STANDARD Pressure Rating (bar)				
	1 & 2 (mm)	3 Metric							EO			EO-2	
									A3C	71	MS	A3C	71
TH06LMKDS	6	M10 x 1	2.5	12.0	10.5	24	17	17	315			315	
TH08LMKDS	8	M12 x 1.5	3.0	14.5	14.0	30	22	19	315			315	
TH10LMKDS	10	M14 x 1.5	3.0	15.5	14.0	30	22	19	315			315	
TH12LMKDS	12	M16 x 1.5	3.0	18.0	16.5	36	27	24	315			315	
TH15LMKDS	15	M18 x 1.5	3.0	21.5	18.5	39.5	30	30	315			315	
TH18LMKDS	18	M22 x 1.5	4.5	21.0	21.5	45	32	30	315			315	
TH22LMKDS	22	M26 x 1.5	3.5	27.5	24.0	53	41	36	160			160	
TH28LMKDS	28	M33 x 2	3.5	32.0	30.5	66	50	46	160			160	
TH35LMKDS	35	M42 x 2	3.5	36.0	35.5	76	60	55	160			160	
TH42LMKDS	42	M48 x 2	3.5	40.5	40.5	87	70	60	160			160	
TH06SMKDS	6	M12 x 1.5	3.0	16.5	14.0	30	22	19	400			400	
TH08SMKDS	8	M14 x 1.5	3.0	16.5	14.0	30	22	19	400			400	
TH10SMKDS	10	M16 x 1.5	3.0	18.5	16.5	36	27	24	400			400	
TH12SMKDS	12	M18 x 1.5	3.0	20.0	18.5	39.5	27	27	400			400	
TH14SMKDS	14	M20 x 1.5	3.0	22.5	20.0	43.5	32	30					
TH16SMKDS	16	M22 x 1.5	4.5	22.0	21.5	45	32	30	315			315	
TH20SMKDS	20	M27 x 2	3.5	26.5	24.0	53	41	36	315			315	
TH25SMKDS	25	M33 x 2	3.5	31.5	30.5	66	50	46	250			250	
TH30SMKDS	30	M42 x 2	3.5	37.0	35.5	76	60	55	160			160	
TH38SMKDS	38	M48 x 2	3.5	41.5	40.5	87	70	60	160			160	

For EO-2 part number, insert "Z" between size and pressure series.
Example: TH06ZLMKDSA3C



K Full Dimensions

Union Cross
24° Flareless

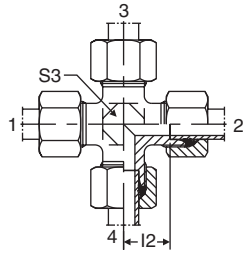

TUBE FITTING PART #	END SIZE			STANDARD Pressure Rating (bar)					
	1 - 4 (mm)	12 (mm)	S3 (mm)	EO			EO-2		
				A3C	71	MS	A3C	71	
K04LL	4	11.0	9	100					
K06LL	6	9.5	9	100					
K08LL	8	11.5	12	100					
K06L	6	12.0	12	315	315		315	315	
K08L	8	14.0	12	315	315		315	315	
K10L	10	15.0	14	315	315		315	315	
K12L	12	17.0	17	315	315		315	315	
K15L	15	21.0	19	315	315		315	315	
K18L	18	23.5	24	315	315		315	315	
K22L	22	27.5	27	160	160		160	160	
K28L	28	30.5	36	160			160		
K35L	35	34.5	41	160			160		
K42L	42	40.0	50	160			160		
K06S	6	16.0	12	630	630		630	630	
K08S	8	17.0	14	630	630		630	630	
K10S	10	17.5	17	630	630		630	630	
K12S	12	21.5	17	630	630		630	630	
K14S	14	22.0	19	630			630		
K16S	16	24.5	24	400	400		400	400	
K20S	20	26.5	27	400	400		400	400	
K25S	25	30.0	36	400			400		
K30S	30	35.5	41	400			400		
K38S	38	41.0	50	315			315		

For EO-2 part number, insert "Z" between size and pressure series.
Example: K06ZLA3C

VKA Full Dimensions

Cap

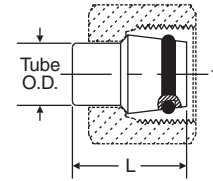

TUBE FITTING PART #	END SIZE		STANDARD Pressure Rating (bar)		
	1 (mm)	L (mm)	EO		
			A3C	71	MS
VKA06	6	18.5	315	315	205
VKA08	8	18.5	315	315	205
VKA10	10	20.0	315	315	205
VKA12	12	20.5	315	315	205
VKA15	15	20.5	315	315	205
VKA18	18	22.5	315	315	205
VKA22	22	25.0	160	160	104
VKA28	28	25.5	160	160	104
VKA35	35	30.0	160	160	
VKA42	42	30.0	160	160	
VKA06	6	18.5	630	630	410
VKA08	8	18.5	630	630	410
VKA10	10	20.0	630	630	410
VKA12	12	20.5	630	630	410
VKA14	14	22.5	630	630	410
VKA16	16	23.5	400	400	260
VKA20	20	28.5	400	400	260
VKA25	25	29.0	400	400	260
VKA30	30	30.5	400	400	
VKA38	38	33.0	315	315	

ROV Full Dimensions

Plug
24° Flareless

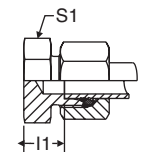

TUBE FITTING PART #	END SIZE			STANDARD Pressure Rating (bar)					
	1 (mm)	I1 (mm)	S1 (mm)	EO			EO-2		
				A3C	71	MS	A3C	71	
ROV06L	6	7	12	315	315		315	315	
ROV08L	8	8	14	315	315		315	315	
ROV10L	10	9	17	315	315		315	315	
ROV12L	12	10.0	19	315	315		315	315	
ROV15L	15	11.0	24	315	315		315	315	
ROV18L	18	11.5	27	315	315		315	315	
ROV22L	22	13.5	32	160	160		160	160	
ROV28L	28	14.5	41	160	160		160	160	
ROV35L	35	14.5	46	160			160		
ROV42L	42	16.0	55	160			160		
ROV06S	6	11.0	14	630	630		630	630	
ROV08S	8	13.0	17	630	630		630	630	
ROV10S	10	12.5	19	630	630		630	630	
ROV12S	12	14.5	22	630	630		630	630	
ROV14S	14	16.0	24	630	630		630	630	
ROV16S	16	15.5	27	400	400		400	400	
ROV20S	20	17.5	32	400	400		400	400	
ROV25S	25	20.0	41	400	400		400	400	
ROV30S	30	20.5	46	400			400		
ROV38S	38	23.0	55	315			315		

For EO-2 part number, insert "Z" between size and pressure series.
Example: ROV06ZLA3C



DVGE-R Full Dimensions

Plain Bearing Rotary Straight
24° Flareless / BSPP with EOlastic Seal*

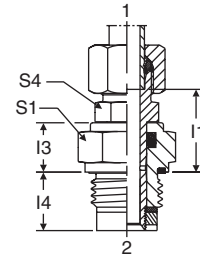

- How to Order
- Specs
- Assembly / Installation
- Reference

TUBE FITTING PART #	END SIZE		I1 (mm)	I2 (mm)	I3 (mm)	I4 (mm)	L3 (mm)	S1 (mm)	S3 (mm)	S4 (mm)	STANDARD Pressure Rating (bar)		
	1 (mm)	2 BSPP*									EO		
											A3C	71	MS
DVGE06LR	6	G 1/4 A	21.0	12.0	12.0	18.0	20.0	19	12	12	40		
DVGE08LR	8	G 1/4 A	21.0	14.0	12.0	18.0	21.0	19	12	14	40		
DVGE10LR	10	G 3/8 A	25.0	15.0	14.5	18.0	26.0	24	14	17	40		
DVGE12LR	12	G 1/2 A	27.0	17.0	15.0	21.0	27.0	27	17	19	40		
DVGE15LR	15	G 3/4 A	32.0	21.0	18.0	24.0	33.0	32	19	24	40		
DVGE18LR	18	G 1 A	35.0	23.5	20.0	27.5	37.5	41	27	27	40		
DVGE22LR	22	G 1 A	39.0	27.5	20.0	27.5	39.5	41	27	32	40		
DVGE28LR	28	G 1 1/4 A	40.5	30.5	20.0	31.0	44.0	50	36	41	40		
DVGE35LR	35	G 1/2 A	44.5	34.5	24.0	35.0	54.0	55	41	46	40		
DVGE06SR	6	G 1/4 A	23.0	16.0	12.0	18.0	21.0	19	12	14	100		
DVGE08SR	8	G 1/4 A	24.0	17.0	12.0	18.0	22.0	19	14	17	100		
DVGE10SR	10	G 3/8 A	26.5	17.5	14.5	18.0	27.0	24	17	19	100		
DVGE12SR	12	G 1/2 A	28.5	21.5	15.0	21.0	28.0	27	17	22	100		
DVGE16SR	16	G 3/4 A	33.5	24.5	18.0	24.0	34.0	32	24	27	100		
DVGE20SR	20	G 1 A	38.0	26.5	20.0	27.5	39.5	41	27	32	100		
DVGE25SR	25	G 1 A	40.5	30.0	20.0	27.5	42.5	41	36	41	100		
DVGE30SR	30	G 1 1/4 A	41.5	35.5	20.0	31.0	48.0	50	41	46	100		
DVGE38SR	38	G 1 1/2 A	47.0	41.0	24.0	35.0	55.0	55	50	55	100		

*Note: Part depth must be deeper than standard DIN 3852-2.

DVWE-R Full Dimensions

Plain Bearing Rotary Elbow
24° Flareless / BSPP with EOlastic Seal*

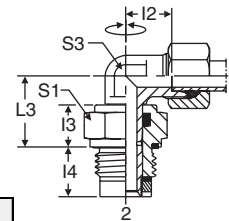

TUBE FITTING PART #	END SIZE		I1 (mm)	I2 (mm)	I3 (mm)	I4 (mm)	L3 (mm)	S1 (mm)	S3 (mm)	S4 (mm)	STANDARD Pressure Rating (bar)		
	1 (mm)	2 BSPP*									EO		
											A3C	71	MS
DVWE06LR	6	G 1/4 A	21.0	12.0	12.0	18.0	20.0	19	12	12	40		
DVWE08LR	8	G 1/4 A	21.0	14.0	12.0	18.0	21.0	19	12	14	40		
DVWE10LR	10	G 3/8 A	25.0	15.0	14.5	18.0	26.0	24	14	17	40		
DVWE12LR	12	G 1/2 A	27.0	17.0	15.0	21.0	27.0	27	17	19	40		
DVWE15LR	15	G 3/4 A	32.0	21.0	18.0	24.0	33.0	32	19	24	40		
DVWE18LR	18	G 1 A	35.0	23.5	20.0	27.5	37.5	41	27	27	40		
DVWE22LR	22	G 1 A	39.0	27.5	20.0	27.5	39.5	41	27	32	40		
DVWE28LR	28	G 1 1/4 A	40.5	30.5	20.0	31.0	44.0	50	36	41	40		
DVWE35LR	35	G 1/2 A	44.5	34.5	24.0	35.0	54.0	55	41	46	40		
DVWE06SR	6	G 1/4 A	23.0	16.0	12.0	18.0	21.0	19	12	14	100		
DVWE08SR	8	G 1/4 A	24.0	17.0	12.0	18.0	22.0	19	14	17	100		
DVWE10SR	10	G 3/8 A	26.5	17.5	14.5	18.0	27.0	24	17	19	100		
DVWE12SR	12	G 1/2 A	28.5	21.5	15.0	21.0	28.0	27	17	22	100		
DVWE16SR	16	G 3/4 A	33.5	24.5	18.0	24.0	34.0	32	24	27	100		
DVWE20SR	20	G 1 A	38.0	26.5	20.0	27.5	39.5	41	27	32	100		
DVWE25SR	25	G 1 A	40.5	30.0	20.0	27.5	42.5	41	36	41	100		
DVWE30SR	30	G 1 1/4 A	41.5	35.5	20.0	31.0	48.0	50	41	46	100		
DVWE38SR	38	G 1 1/2 A	47.0	41.0	24.0	35.0	55.0	55	50	55	100		

*Note: Part depth must be deeper than standard DIN 3852-2.

DVGE-M Full Dimensions

Plain Bearing Rotary Straight
24° Flareless / Metric Parallel with EOlastic Seal*

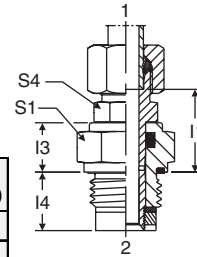

TUBE FITTING PART #	END SIZE		I1 (mm)	I2 (mm)	I3 (mm)	I4 (mm)	L3 (mm)	S1 (mm)	S3 (mm)	S4 (mm)	STANDARD Pressure Rating (bar)		
	1 (mm)	2 Metric*									EO		
											A3C	71	MS
DVGE06LM	6	M 14 x 1.5	20.0	12.0	12.0	18.0	20.0	19	12	12	40		
DVGE08LM	8	M 14 x 1.5	21.0	14.0	12.0	18.0	21.0	19	12	14	40		
DVGE10LM	10	M 18 x 1.5	26.0	15.0	14.5	18.0	26.0	24	14	17	40		
DVGE12LM	12	M 22 x 1.5	27.0	17.0	15.0	21.0	27.0	27	17	19	40		
DVGE15LM	15	M 27 x 2	33.0	21.0	18.0	24.0	33.0	32	19	24	40		
DVGE18LM	18	M 33 x 2	37.5	23.5	20.0	27.5	37.5	41	27	27	40		
DVGE22LM	22	M 33 x 2	39.5	27.5	20.0	27.5	39.5	41	27	32	40		
DVGE28LM	28	M 42 x 2	44.0	30.5	20.0	31.0	44.0	50	36	41	40		
DVGE35LM	35	M 48 x 2	54.0	34.5	24.0	35.0	54.0	55	41	46	40		
DVGE06SM	6	M 14 x 1.5	21.0	16.0	12.0	18.0	21.0	19	12	14	100		
DVGE08SM	8	M 14 x 1.5	22.0	17.0	12.0	18.0	22.0	19	14	17	100		
DVGE10SM	10	M 18 x 1.5	27.0	17.5	14.5	18.0	27.0	24	17	19	100		
DVGE12SM	12	M 22 x 1.5	28.0	21.5	15.0	21.0	28.0	27	17	22	100		
DVGE16SM	16	M 27 x 2	34.0	24.5	18.0	24.0	34.0	32	24	27	100		
DVGE20SM	20	M 33 x 2	39.5	26.5	20.0	27.5	39.5	41	27	32	100		
DVGE25SM	25	M 33 x 2	42.5	30.0	20.0	27.5	42.5	41	36	41	100		
DVGE30SM	30	M 42 x 2	48.0	35.5	20.0	31.0	48.0	50	41	46	100		
DVGE38SM	38	M 48 x 2	55.0	41.0	24.0	35.0	55.0	55	50	55	100		

*Note: Part depth must be deeper than standard DIN 3852-1.

DVWE-M Full Dimensions

Plain Bearing Rotary Elbow
24° Flareless / Metric Parallel with EOlastic Seal*

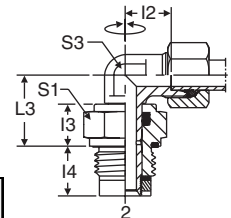

TUBE FITTING PART #	END SIZE		I1 (mm)	I2 (mm)	I3 (mm)	I4 (mm)	L3 (mm)	S1 (mm)	S3 (mm)	S4 (mm)	STANDARD Pressure Rating (bar)		
	1 (mm)	2 Metric*									EO		
											A3C	71	MS
DVWE06LM	6	M 14 x 1.5	20.0	12.0	12.0	18.0	20.0	19	12	12	40		
DVWE08LM	8	M 14 x 1.5	21.0	14.0	12.0	18.0	21.0	19	12	14	40		
DVWE10LM	10	M 18 x 1.5	26.0	15.0	14.5	18.0	26.0	24	14	17	40		
DVWE12LM	12	M 22 x 1.5	27.0	17.0	15.0	21.0	27.0	27	17	19	40		
DVWE15LM	15	M 27 x 2	33.0	21.0	18.0	24.0	33.0	32	19	24	40		
DVWE18LM	18	M 33 x 2	37.5	23.5	20.0	27.5	37.5	41	27	27	40		
DVWE22LM	22	M 33 x 2	39.5	27.5	20.0	27.5	39.5	41	27	32	40		
DVWE28LM	28	M 42 x 2	44.0	30.5	20.0	31.0	44.0	50	36	41	40		
DVWE35LM	35	M 48 x 2	54.0	34.5	24.0	35.0	54.0	55	41	46	40		
DVWE06SM	6	M 14 x 1.5	21.0	16.0	12.0	18.0	21.0	19	12	14	100		
DVWE08SM	8	M 14 x 1.5	22.0	17.0	12.0	18.0	22.0	19	14	17	100		
DVWE10SM	10	M 18 x 1.5	27.0	17.5	14.5	18.0	27.0	24	17	19	100		
DVWE12SM	12	M 22 x 1.5	28.0	21.5	15.0	21.0	28.0	27	17	22	100		
DVWE16SM	16	M 27 x 2	34.0	24.5	18.0	24.0	34.0	32	24	27	100		
DVWE20SM	20	M 33 x 2	39.5	26.5	20.0	27.5	39.5	41	27	32	100		
DVWE25SM	25	M 33 x 2	42.5	30.0	20.0	27.5	42.5	41	36	41	100		
DVWE30SM	30	M 42 x 2	48.0	35.5	20.0	31.0	48.0	50	41	46	100		
DVWE38SM	38	M 48 x 2	55.0	41.0	24.0	35.0	55.0	55	50	55	100		

*Note: Part depth must be deeper than standard DIN 3852-1.



DG101 Full Dimensions

Ball Bearing Rotary Union
24° Flareless / 24° Flareless

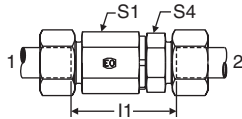

TUBE FITTING PART #	END SIZE		I1 (mm)	S1 (mm)	S4 (mm)	STANDARD Pressure Rating (bar)*		
	1 & 2 (mm)	EO						
		A3C				71	MS	
DG101/06S	6	47	22	17	•			
DG101/08S	8	47	22	17	•			
DG101/12S	12	57	30	24	•			
DG101/16S	16	57	30	27	•			
DG101/20S	20	71	41	36	•			
DG101/25S	25	72	41	41	•			
DG101/30S	30	82	60	46	•			
DG101/38S	38	82	60	55	•			

Note: See Table F1 on page F7 for RPM/working pressure data.

DG103 Full Dimensions

Ball Bearing Rotary Elbow
24° Flareless / 24° Flareless

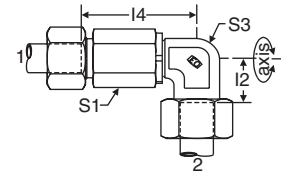

TUBE FITTING PART #	END SIZE		I2 (mm)	I4 (mm)	S1 (mm)	S3 (mm)	STANDARD Pressure Rating (bar)*		
	1 & 2 (mm)	EO							
		A3C					71	MS	
DG103/06S	6	16.0	44.5	22	17	•			
DG103/08S	8	17.0	44.5	22	17	•			
DG103/12S	12	21.5	55.5	30	22	•			
DG103/16S	16	24.5	54.5	30	22	•			
DG103/20S	20	26.5	72.5	41	36	•			
DG103/25S	25	30.0	71.0	41	36	•			
DG103/30S	30	35.5	89.0	60	50	•			
DG103/38S	38	41.0	86.5	60	50	•			

Note: See Table F1 on page F7 for RPM/working pressure data.

DG105 Full Dimensions

Ball Bearing Rotary Union
24° Flareless / 24° Flareless

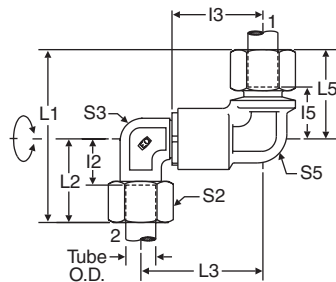

TUBE FITTING PART #	END SIZE		I2 (mm)	I3 (mm)	I5 (mm)	L3 (mm)	S3 (mm)	S5 (mm)	STANDARD Pressure Rating (bar)*		
	1 & 2 (mm)	EO									
		A3C							71	MS	
DG105/12S	12	21.5	39.5	26.5	53.0	22	24	•			
DG105/16S	16	24.5	39.5	25.5	53.0	22	24	•			
DG105/20S	20	26.5	56.5	39.5	76.0	36	32	•			
DG105/25S	25	30.0	56.5	38.0	76.0	36	32	•			
DG105/30S	30	35.5	65.0	44.5	92.5	50	50	•			
DG105/38S	38	41.0	65.0	42.0	92.5	50	50	•			

Note: See Table F1 on page F7 for RPM/working pressure data.

DG107 Full Dimensions

Ball Bearing Rotary Bulkhead Union
24° Flareless / 24° Flareless

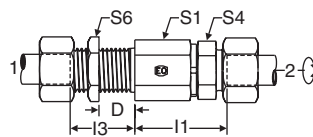

TUBE FITTING PART #	END SIZE		D (mm)	I1 (mm)	I3 (mm)	S1 (mm)	S4 (mm)	S6 (mm)	STANDARD Pressure Rating (bar)*		
	1 & 2 (mm)	EO									
		A3C							71	MS	
DG107/06S	6	5	42.0	16.0	22	17	19	•			
DG107/08S	8	5	42.0	16.0	22	17	22	•			
DG107/12S	12	5	52.5	15.5	30	24	27	•			
DG107/16S	16	5	51.2	17.5	30	27	32	•			
DG107/20S	20	15	65.5	28.5	41	36	41	•			
DG107/25S	25	15	66.0	30.0	41	41	46	•			
DG107/30S	30	15	75.5	30.5	60	46	50	•			
DG107/38S	38	15	76.0	31.0	60	55	65	•			

Note: See Table F1 on page F7 for RPM/working pressure data.



DG108 Full Dimensions

Ball Bearing Rotary Bulkhead Elbow
24° Flareless / 24° Flareless

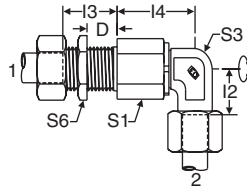

TUBE FITTING PART #	END SIZE		D (mm)	I2 (mm)	I3 (mm)	I4 (mm)	S1 (mm)	S3 (mm)	S6 (mm)	STANDARD Pressure Rating (bar)*		
	1 & 2 (mm)	EO										
		A3C								71	MS	
DG108/06S	6	5	16.0	16.0	39.5	17	17	19	•			
DG108/08S	8	5	17.0	16.0	39.5	17	17	22	•			
DG108/12S	12	5	21.5	15.5	51.0	24	22	27	•			
DG108/16S	16	5	24.5	17.5	49.0	27	22	32	•			
DG108/20S	20	15	26.5	28.5	67.0	36	36	41	•			
DG108/25S	25	15	30.0	30.0	65.0	41	36	46	•			
DG108/30S	30	15	35.5	30.5	82.5	46	50	50	•			
DG108/38S	38	15	41.0	31.0	80.5	55	50	65	•			

Note: See Table F1 on page F7 for RPM/working pressure data.

DG102-R Full Dimensions

Ball Bearing Rotary Straight
24° Flareless / BSPP

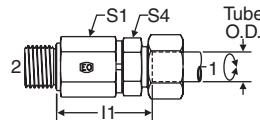

TUBE FITTING PART #	END SIZE		I1 (mm)	S1 (mm)	S4 (mm)	STANDARD Pressure Rating (bar)*		
	1 (mm)	2 BSPP				EO		
						A3C	71	MS
DG102/06SR	6	G 1/4 A	42.0	22	17	•		
DG102/08SR	8	G 1/4 A	42.0	22	17	•		
DG102/12SR	12	G 3/8 A	52.5	30	24	•		
DG102/16SR	16	G 1/2 A	51.5	30	27	•		
DG102/20SR	20	G 3/4 A	65.5	41	36	•		
DG102/25SR	25	G 1 A	66.0	41	41	•		
DG102/30SR	30	G 1 1/4 A	75.5	60	46	•		
DG102/38SR	38	G 1 1/2 A	76.0	60	55	•		

Note: See Table F1 on page F7 for RPM/working pressure data.

DG102-M Full Dimensions

Ball Bearing Rotary Straight
24° Flareless / Metric Parallel

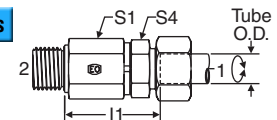

TUBE FITTING PART #	END SIZE		I1 (mm)	S1 (mm)	S4 (mm)	STANDARD Pressure Rating (bar)*		
	1 (mm)	2 Metric				EO		
						A3C	71	MS
DG102/06SM	6	M14 x 1.5	42.0	22	17	•		
DG102/08SM	8	M14 x 1.5	42.0	22	17	•		
DG102/12SM	12	M18 x 1.5	52.5	30	24	•		
DG102/16SM	16	M22 x 1.5	51.5	30	27	•		
DG102/20SM	20	M27 x 2	65.5	41	36	•		
DG102/25SM	25	M33 x 2	66.0	41	41	•		
DG102/30SM	30	M42 x 2	75.5	60	46	•		
DG102/38SM	38	M48 x 2	76.0	60	55	•		

Note: See Table F1 on page F7 for RPM/working pressure data.

DG104-R Full Dimensions

Ball Bearing Rotary Elbow
24° Flareless / BSPP with EOlastic Seal

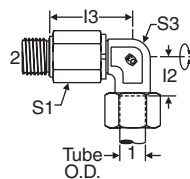

TUBE FITTING PART #	END SIZE		I2 (mm)	I3 (mm)	S1 (mm)	S3 (mm)	STANDARD Pressure Rating (bar)*		
	1 (mm)	2 BSPP					EO		
							A3C	71	MS
DG104/06SR	6	G 1/4 A	16.0	39.5	22	17	•		
DG104/08SR	8	G 1/4 A	17.0	39.5	22	17	•		
DG104/12SR	12	G 3/8 A	21.5	51.0	30	22	•		
DG104/16SR	16	G 1/2 A	24.5	49.0	30	22	•		
DG104/20SR	20	G 3/4 A	26.5	67.0	41	36	•		
DG104/25SR	25	G 1 A	30.0	65.0	41	36	•		
DG104/30SR	30	G 1 1/4 A	35.5	82.5	60	50	•		
DG104/38SR	38	G 1 1/2 A	41.0	80.5	60	50	•		

Note: See Table F1 on page F7 for RPM/working pressure data.



DG104-M Full Dimensions

Ball Bearing Rotary Elbow
24° Flareless / Metric Parallel

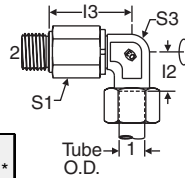

TUBE FITTING PART #	END SIZE		I2 (mm)	I3 (mm)	S1 (mm)	S3 (mm)	STANDARD Pressure Rating (bar)*		
	1 (mm)	2 Metric					EO		
							A3C	71	MS
DG104/06SM	6	M14 x 1.5	16.0	39.5	22	17	•		
DG104/08SM	8	M14 x 1.5	17.0	39.5	22	17	•		
DG104/12SM	12	M18 x 1.5	21.5	51.0	30	22	•		
DG104/16SM	16	M22 x 1.5	24.5	49.0	30	22	•		
DG104/20SM	20	M27 x 2	26.5	67.0	41	36	•		
DG104/25SM	25	M33 x 2	30.0	65.0	41	36	•		
DG104/30SM	30	M42 x 2	35.5	82.5	60	50	•		
DG104/38SM	38	M48 x 2	41.0	80.5	60	50	•		

Note: See Table F1 on page F7 for RPM/working pressure data.



DG106-R Full Dimensions

Ball Bearing Rotary Double Elbow
24° Flareless / BSPP with EOlastic Seal

TUBE FITTING PART #	END SIZE		I1 (mm)	I3 (mm)	I5 (mm)	L3 (mm)	S1 (mm)	S3 (mm)	S5 (mm)	STANDARD Pressure Rating (bar)*		
	1 (mm)	2 BSPP								EO		
										A3C	71	MS
DG106/12SR	12	G 3/8 A	55.5	39.5	26.5	53.0	22	24	22	•		
DG106/16SR	16	G 1/2 A	61.5	39.5	25.5	53.0	27	24	24	•		
DG106/20SR	20	G 3/4 A	69.5	56.5	39.5	76.0	32	36	32	•		
DG106/25SR	25	G 1 A	78.0	56.5	38.0	76.0	41	36	32	•		
DG106/30SR	30	G 1 1/4 A	86.5	65.0	44.5	92.5	50	50	50	•		
DG106/38SR	38	G 1 1/2 A	101.0	65.0	42.0	92.5	55	50	50	•		

Note: See Table F1 on page F7 for RPM/working pressure data.

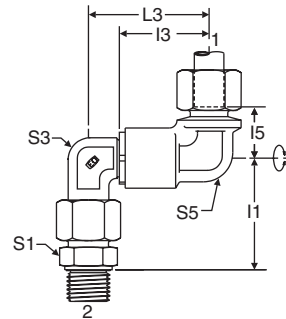

DG106-M Full Dimensions

Ball Bearing Rotary Double Elbow
24° Flareless / Metric Parallel

TUBE FITTING PART #	END SIZE		I1 (mm)	I3 (mm)	I5 (mm)	L3 (mm)	S1 (mm)	S3 (mm)	S5 (mm)	STANDARD Pressure Rating (bar)*		
	1 (mm)	2 Metric								EO		
										A3C	71	MS
DG106/12SM	12	M18 x 1.5	55.5	39.5	26.5	53.0	24	24	24	•		
DG106/16SM	16	M22 x 1.5	61.5	39.5	25.5	53.0	27	24	24	•		
DG106/20SM	20	M27 x 2	69.5	56.5	39.5	76.0	32	36	32	•		
DG106/25SM	25	M33 x 2	78.0	56.5	38.0	76.0	41	36	32	•		
DG106/30SM	30	M42 x 2	86.5	65.0	44.5	92.5	50	50	50	•		
DG106/38SM	38	M48 x 2	101.0	65.0	42.0	92.5	55	50	50	•		

Note: See Table F1 on page F7 for RPM/working pressure data.

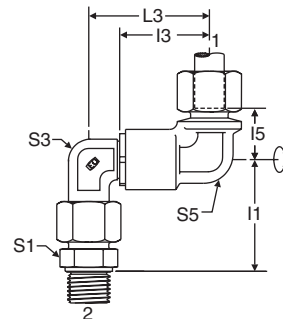

RHD

Non-Return Valve
24° Flareless / 24° Flareless

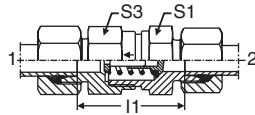

TUBE FITTING PART #	END SIZE 1 & 2 (mm)	DN SIZE (mm)	I 1 (mm)	S1 (mm)	S3 (mm)	STANDARD Pressure Rating (bar)				
						EO			EO-2	
						A3C	71	MS	A3C	71
RHD06L	6	4	29.0	17	17	250	250		250	250
RHD08L	8	6	30.0	19	19	250	250		250	250
RHD10L	10	8	40.5	22	24	250	250		250	250
RHD12L	12	10	43.5	27	30	250	250		250	250
RHD15L	15	12	47.5	27	32	250	250		250	250
RHD18L	18	16	51.5	36	36	160	160		160	160
RHD22L	22	20	61.5	41	46	160	160		160	160
RHD28L	28	25	69.5	50	55	100	100		100	100
RHD35L	35	32	74.5	60	60	100	100		100	100
RHD42L	42	32	74.0	65	70	100	100		100	100
RHD06S	6	3	34.5	19	19	400	400		400	400
RHD08S	8	4	34.5	19	19	400	400		400	400
RHD10S	10	6	40.5	22	24	400	400		400	400
RHD12S	12	8	42.5	24	27	400	400		400	400
RHD14S	14	10	47.5	27	32	315	315		315	315
RHD16S	16	12	50.5	32	36	315	315		315	315
RHD20S	20	16	54.5	41	46	250	250		250	250
RHD25S	25	20	58.5	46	50	250	250		250	250
RHD30S	30	25	69.5	60	60	250	250		250	250
RHD38S	38	32	75.5	65	70	250	250		250	250

For EO-2 part number, insert "Z" between size and pressure series.
Example: RHD06ZLA3C

Note: These valves are not compatible with steam, oxygen and explosive gases. For non-return valves compatible with dry air in a pneumatic application, add "Lufdicht / gas tight" to the part number.

RHV-R-ED

Full Dimensions

Non-Return Valve
24° Flareless / BSPP
with EOlastic Seal

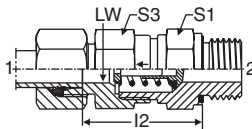

TUBE FITTING PART #	END SIZE		DN SIZE (mm)	I 2 (mm)	S1 (mm)	S3 (mm)	STANDARD Pressure Rating (bar)				
	1 (mm)	2 BSPP					EO			EO-2	
							A3C	71	MS	A3C	71
RHV06LRED	6	G 1/8 A	4	28.0	17	17	250	250		250	250
RHV08LRED	8	G 1/4 A	6	30.0	19	19	250	250		250	250
RHV10LRED	10	G 1/4 A	8	38.5	22	24	250	250		250	250
RHV12LRED	12	G 3/8 A	10	42.5	27	30	250	250		250	250
RHV15LRED	15	G 1/2 A	12	45.5	27	32	250	250		250	250
RHV18LRED	18	G 1/2 A	16	50.0	36	36	160	160		160	160
RHV22LRED	22	G 3/4 A	20	55.0	41	46	160	160		160	160
RHV28LRED	28	G 1 A	25	63.0	50	55	100	100		100	100
RHV35LRED	35	G 1 1/4 A	32	69.0	60	60	100	100		100	100
RHV42LRED	42	G 1 1/2 A	32	68.5	65	70	100	100		100	100
RHV06SRED	6	G 1/4 A	3	31.5	19	19	400	400		400	400
RHV08SRED	8	G 1/4 A	4	31.5	19	19	400	400		400	400
RHV10SRED	10	G 3/8 A	6	38.0	22	24	400	400		400	400
RHV12SRED	12	G 3/8 A	8	41.0	24	27	400	400		400	400
RHV14SRED	14	G 1/2 A	10	44.5	27	32	315	315		315	315
RHV16SRED	16	G 1/2 A	12	48.0	32	36	315	315		315	315
RHV20SRED	20	G 3/4 A	16	52.0	41	46	250	250		250	250
RHV25SRED	25	G 1 A	20	54.5	46	50	250	250		250	250
RHV30SRED	30	G 1 1/4 A	25	64.0	60	60	250	250		250	250
RHV38SRED	38	G 1 1/2 A	32	69.5	65	70	250	250		250	250

For EO-2 part number, insert "Z" between size and pressure series.
Example: RHV06ZLREDA3C

Note: These valves are not compatible with steam, oxygen and explosive gases. For non-return valves compatible with dry air in a pneumatic application, add "Lufdicht / gas tight" to the part number.



RHV-M-ED

Full Dimensions

Non-Return Valve
24° Flareless / Metric Parallel
with EOlastic Seal

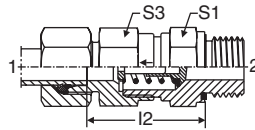

TUBE FITTING PART #	END SIZE		DN SIZE (mm)	I 2 (mm)	S1 (mm)	S3 (mm)	STANDARD Pressure Rating (bar)				
	1 (mm)	2 Metric					EO			EO-2	
							A3C	71	MS	A3C	71
RHV06LMED	6	M10 x 1	4	28.0	17	17	250	250		250	250
RHV08LMED	8	M12 x 1.5	6	29.0	19	19	250	250		250	250
RHV10LMED	10	M14 x 1.5	8	38.5	22	24	250	250		250	250
RHV12LMED	12	M16 x 1.5	10	42.5	27	30	250	250		250	250
RHV15LMED	15	M18 x 1.5	12	45.5	27	32	250	250		250	250
RHV18LMED	18	M22 x 1.5	16	50.0	36	36	160	160		160	160
RHV22LMED	22	M26 x 1.5	20	55.0	41	46	160	160		160	160
RHV28LMED	28	M33 x 2	25	63.0	50	55	100	100		100	100
RHV35LMED	35	M42 x 2	32	69.0	60	60	100	100		100	100
RHV42LMED	42	M48 x 2	32	68.5	65	70	100	100		100	100
RHV06SMED	6	M12 x 1.5	3	31.5	19	19	400	400		400	400
RHV08SMED	8	M14 x 1.5	4	31.5	19	19	400	400		400	400
RHV10SMED	10	M16 x 1.5	6	38.0	22	24	400	400		400	400
RHV12SMED	12	M18 x 1.5	8	41.0	24	27	400	400		400	400
RHV14SMED	14	M20 x 1.5	10	44.5	27	32	315	315		315	315
RHV16SMED	16	M22 x 1.5	12	48.0	32	36	315	315		315	315
RHV20SMED	20	M27 x 2	16	52.0	41	46	250	250		250	250
RHV25SMED	25	M33 x 2	20	54.5	46	50	250	250		250	250
RHV30SMED	30	M42 x 2	25	64.0	60	60	250	250		250	250
RHV38SMED	38	M48 x 2	32	69.5	65	70	250	250		250	250

For EO-2 part number, insert "Z" between size and pressure series.
Example: RHV06ZLMEDA3C

Note: These valves are not compatible with steam, oxygen and explosive gases. For non-return valves compatible with dry air in a pneumatic application, add "Lufdicht / gas tight" to the part number.

RHZ-R-ED

Full Dimensions

Non-Return Valve
24° Flareless / BSPP

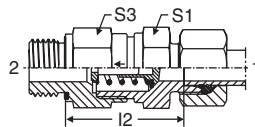

TUBE FITTING PART #	END SIZE		DN SIZE (mm)	I 2 (mm)	S1 (mm)	S3 (mm)	STANDARD Pressure Rating (bar)				
	1 (mm)	2 BSPP					EO			EO-2	
							A3C	71	MS	A3C	71
RHZ06LRED	6	G 1/8 A	4	26.5	17	17	250	250		250	250
RHZ08LRED	8	G 1/4 A	6	28.5	19	19	250	250		250	250
RHZ10LRED	10	G 1/4 A	8	38.5	22	24	250	250		250	250
RHZ12LRED	12	G 3/8 A	10	40.5	27	30	250	250		250	250
RHZ15LRED	15	G 1/2 A	12	42.5	27	32	250	250		250	250
RHZ18LRED	18	G 1/2 A	16	48.0	36	36	160	160		160	160
RHZ22LRED	22	G 3/4 A	20	56.0	41	46	160	160		160	160
RHZ28LRED	28	G 1 A	25	64.0	50	55	100	100		100	100
RHZ35LRED	35	G 1 1/4 A	32	70.0	60	60	100	100		100	100
RHZ42LRED	42	G 1 1/2 A	32	70.5	65	70	100	100		100	100
RHZ06SRED	6	G 1/4 A	3	31.5	19	19	400	400		400	400
RHZ08SRED	8	G 1/4 A	4	31.5	19	19	400	400		400	400
RHZ10SRED	10	G 3/8 A	6	38.0	22	24	400	400		400	400
RHZ12SRED	12	G 3/8 A	8	41.0	24	27	400	400		400	400
RHZ14SRED	14	G 1/2 A	10	43.5	27	32	315	315		315	315
RHZ16SRED	16	G 1/2 A	12	46.0	32	36	315	315		315	315
RHZ20SRED	20	G 3/4 A	16	50.0	41	46	250	250		250	250
RHZ25SRED	25	G 1 A	20	54.5	46	50	250	250		250	250
RHZ30SRED	30	G 1 1/4 A	25	64.0	60	60	250	250		250	250
RHZ38SRED	38	G 1 1/2 A	32	71.5	65	70	250	250		250	250

For EO-2 part number, insert "Z" between size and pressure series.
Example: RHZ06ZLREDA3C

Note: These valves are not compatible with steam, oxygen and explosive gases. For non-return valves compatible with dry air in a pneumatic application, add "Lufdicht / gas tight" to the part number.

- How to Order
- Specs
- Assembly / Installation
- Reference

RHZ-M-ED Full Dimensions

Non-Return Valve
24° Flareless / Metric Parallel with
EOlastic Seal

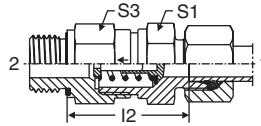

TUBE FITTING PART #	END SIZE		DN SIZE (mm)	I 2 (mm)	S1 (mm)	S3 (mm)	STANDARD Pressure Rating (bar)				
	1 (mm)	2 Metric					EO			EO-2	
							A3C	71	MS	A3C	71
RHZ06LMED	6	M10 x 1	4	26.5	17	17	250	250		250	250
RHZ08LMED	8	M12 x 1.5	6	28.5	19	19	250	250		250	250
RHZ10LMED	10	M14 x 1.5	8	38.5	22	24	250	250		250	250
RHZ12LMED	12	M16 x 1.5	10	40.5	27	30	250	250		250	250
RHZ15LMED	15	M18 x 1.5	12	42.5	27	32	250	250		250	250
RHZ18LMED	18	M22 x 1.5	16	48.0	36	36	160	160		160	160
RHZ22LMED	22	M26 x 1.5	20	56.0	41	46	160	160		160	160
RHZ28LMED	28	M33 x 2	25	64.0	50	55	100	100		100	100
RHZ35LMED	35	M42 x 2	32	70.0	60	60	100	100		100	100
RHZ42LMED	42	M48 x 2	32	70.5	65	70	100	100		100	100
RHZ06SMED	6	M12 x 1.5	3	31.5	19	19	400	400		400	400
RHZ08SMED	8	M14 x 1.5	4	31.5	19	19	400	400		400	400
RHZ10SMED	10	M16 x 1.5	6	38.0	22	24	400	400		400	400
RHZ12SMED	12	M18 x 1.5	8	41.0	24	27	400	400		400	400
RHZ14SMED	14	M20 x 1.5	10	43.5	27	32	315	315		315	315
RHZ16SMED	16	M22 x 1.5	12	46.0	32	36	315	315		315	315
RHZ20SMED	20	M27 x 2	16	50.0	41	46	250	250		250	250
RHZ25SMED	25	M33 x 2	20	54.5	46	50	250	250		250	250
RHZ30SMED	30	M42 x 2	25	64.0	60	60	250	250		250	250
RHZ38SMED	38	M48 x 2	32	71.5	65	70	250	250		250	250

For EO-2 part number, insert "Z" between size and pressure series.
Example: RHZ06ZLMEDA3C

Note: These valves are not compatible with steam, oxygen and explosive gases. For non-return valves compatible with dry air in a pneumatic application, add "Lufdicht / gas tight" to the part number.

RHDI Full Dimensions

Non-Return Valve
BSPP Female / BSPP Female

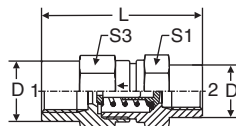

TUBE FITTING PART #	END SIZE 1 & 2 BSPP	DN SIZE (mm)	D (mm)	L (mm)	S1 (mm)	S3 (mm)	STANDARD Pressure Rating (bar)		
							EO		
							A3C	71	MS
RHD11/8	G 1/8	3	19	42.5	19	19	400		
RHD11/4	G 1/4	4	19	51	19	19	400	400	
RHD13/8	G 3/8	8	24	60	24	27	400	400	
RHD11/2	G 1/2	12	32	72	32	36	315	315	
RHD13/4	G 3/4	16	41	84	41	46	250	250	
RHD11	G 1	20	46	95	46	50	250	250	
RHD111/4	G 1 1/4	25	60	110	60	60	250		
RHD111/2	G 1 1/2	32	65	114	65	70	250		

Note: These valves are not compatible with steam, oxygen and explosive gases. For non-return valves compatible with dry air in a pneumatic application, add "Lufdicht / gas tight" to the part number.

- How to Order
- Specs
- Assembly / Installation
- Reference

RVP Full Dimensions

Non-Return Valve Cartridge

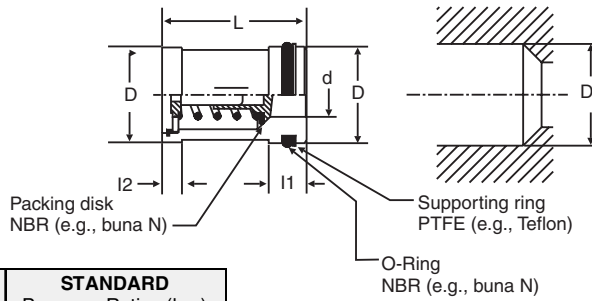

TUBE FITTING PART #	d (mm)	D (mm)	D1 (mm)	I1 (mm)	I2 (mm)	L (mm)	STANDARD Pressure Rating (bar)		
							EO		
							A3C	71	MS
RVP13	3.5	13	13	9.5	6.0	23.0	400		
RVP16	5.5	16	16	9.5	6.5	26.5	400		
RVP20	7.5	20	20	9.5	6.5	30.0	400		
RVP24	9.5	24	24	12.0	7.5	35.0	315		
RVP27	11.5	27	27	12.0	7.5	38.0	315		
RVP35	15.3	35	35	12.0	9.5	44.5	250		
RVP40	19.3	40	40	12.0	11.0	50.5	250		
RVP47	24.3	47	47	13.0	13.0	60.0	250		
RVP55	29.4	55	55	16.0	13.0	70.0	250		

- How to Order
- Specs
- Assembly / Installation
- Reference

I-TL

Non-Return Valve Internal Parts

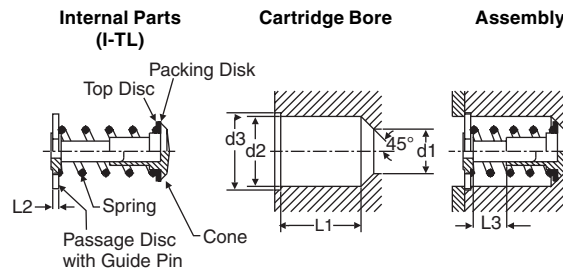

TUBE FITTING PART #	For Use With	d1 (mm)	d2 (mm)	d3 (mm)	L1 (mm)	L2 (mm)	L3 (mm)	STANDARD FROM STOCK		
								A3C	71	MS
ITL06L	6L, 6S, 8S	3.5	7.5	8.55	8.2	2.0	1.0	•		
ITL08L	8L, 10S	5.5	10.2	11.55	11.0	2.0	1.7	•		
ITL10L	10L, 12S	7.5	13.0	14.05	14.0	2.0	2.3	•		
ITL12L	12L, 14S	9.5	16.7	18.05	16.5	2.5	2.9	•		
ITL15L	15L, 16S	11.5	19.5	20.55	19.0	2.5	3.5	•		
ITL18L	18L, 20S	15.3	25.2	27.10	22.5	3.0	4.4	•		
ITL22L	22L, 25S	19.3	30.8	32.60	27.0	3.0	5.5	•		
ITL28L	28L, 30S	24.3	38.6	40.60	32.5	3.5	7.3	•		
ITL35L	35L, 42L, 38S	29.4	45.7	48.10	37.5	3.5	8.9	•		

Note: Omit "A3C" in the part number for steel material.

Standard: Material steel zinc plated (A3K), springs phosphated and oiled. Packing disc of NBR (e.g., buna N), opening pressure 1 bar.

On request:

- Packing disc of FPM (e.g., fluorocarbon)
- Stainless steel 1.4571, packing disc of NBR (e.g., buna N) or FPM (e.g., fluorocarbon) (on request).

Temperature rating, without pressure reductions of steel non-return valves with NBR seals (e.g., buna N-standard) is -35°C to +100°C and with FPM seals (e.g., fluorocarbon) (on request) is -25°C to +120°C.

DV Full Dimensions

Shut-Off Valve, PN 10
24° Flareless / 24° Flareless

TUBE FITTING PART #	END SIZE 1 & 2 (mm)	M Metric	DN SIZE (mm)	d (mm)	D (mm)	h (mm)	H (mm)	I (mm)	S1 (mm)	S3 (mm)	STANDARD Pressure Rating (bar)		
											EO		
											A3C	71	MS
DV06L	6	12 x 1.5	5	10.0	50	7	65	88	22	21			6
DV08L	8	14 x 1.5	6	10.0	50	7	65	88	22	21			6
DV10L	10	16 x 1.5	8	10.0	50	7	65	90	22	21			6
DV12L	12	18 x 1.5	10	10.0	50	7	65	90	22	21			6
DV15L	15	22 x 1.5	12	12.5	50	8	65	93	27	25			6
DV18L	18	26 x 1.5	16	12.5	50	8	67	94	27	25			6
DV22L	22	30 x 2	20	18.0	60	8	67	108	32	32			6
DV28L	28	36 x 2	25	23.5	60	10	95	125	41	38			6
DV35L	35	45 x 2	32	31.0	70	10	102	145	50	47			6

Note: The pressure specification PN for hand operated shut-off valves applies to the design factor 1.5 (according to DIN 3230 T5 and ISO 5208).

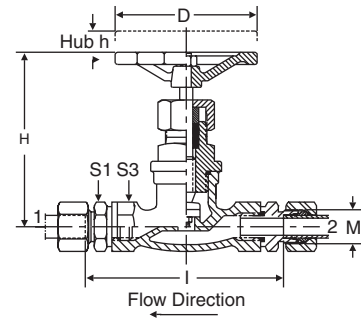

- How to Order
- Specs
- Assembly / Installation
- Reference

LD Full Dimensions

Shut-Off Valve, PN 40
24° Flareless / 24° Flareless

TUBE FITTING PART #	END SIZE 1 & 2 (mm)	DN SIZE (mm)	D (mm)	h LIFT (mm)	H (mm)	I (mm)	STANDARD Pressure Rating (bar)		
							EO		
							A3C	71	MS
LD10S	10	6	63	7	98	45			10
LD12S	12	8	63	7	98	49			10
LD14S	14	10	63	7	98	54			10
LD16S	16	12	80	9	116	67			10
LD20S	20	16	80	9	116	69			10
LD25S	25	20	100	12	129	86			10
LD30S	30	25	100	12	129	93			10
LD38S	38	32	100	12	158	108			10

Note: The pressure specification PN for hand operated shut-off valves applies to the design factor 1.5 (according to DIN 3230 T5 and ISO 5208).

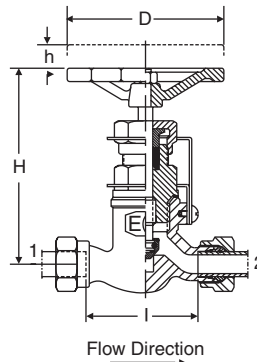

VDHA Full Dimensions

High Pressure Valve
24° Flareless / 24° Flareless

TUBE FITTING PART #	TUBE O.D. (mm)	DN SIZE (mm)	d1 (mm)	d2 (mm)	D (mm)	h (mm)	H (mm)	I (mm)	STANDARD Pressure Rating (bar)					
									EO			EO-2		
									A3C	71	MS	A3C	71	
VDHA06S	6	3	4	9.5	100	6	120	66	250			250		
VDHA08S	8	4	5	9.5	100	6	120	66	250			250		
VDHA10S	10	6	7	9.5	100	6	120	65	250			250		
VDHA12S	12	8	8	9.5	100	6	120	65	250			250		
VDHA14S	14	10	10	9.5	100	6	120	84	250			250		
VDHA16S	16	12	11	9.5	100	6	120	83	160			160		
VDHA20S	20	16	13	11.0	100	6	120	79	160			160		
VDHA25S	25	20	17	12.0	125	9	143	106	160			160		
VDHA30S	30	25	19	22.5	125	12	164	103	100			100		
VDHA38S	38	32	25	26.5	180	12	198	118	100			100		

Note: Weld fitting. Omit "A3C" in the part number for steel material.
For EO-2 part number, insert "Z" between size and pressure series.
Example: VDHA06ZS

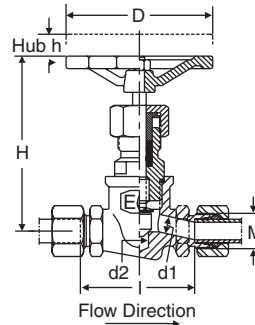

Internal threaded spindle and body of low grade forged stainless steel

- How to Order
- Specs
- Assembly / Installation
- Reference

VDHB Full Dimensions

High Pressure Valve – Panel Mount
24° Flareless / 24° Flareless

TUBE FITTING PART #	TUBE O.D. (mm)	DN SIZE (mm)	M Metric	d1 (mm)	d2 (mm)	D (mm)	h (mm)	H (mm)	I (mm)	STANDARD Pressure Rating (bar)					
										EO			EO-2		
										A3C	71	MS	A3C	71	
VDHB06S	6	4	14 x 1.5	4	9.5	100	6	124	66			160		160	
VDHB08S	8	4	16 x 1.5	5	9.5	100	6	124	66			160		160	
VDHB10S	10	6	18 x 1.5	7	9.5	100	6	124	65			160		160	
VDHB12S	12	8	20 x 1.5	8	9.5	100	6	124	65			160		160	
VDHB14S	14	10	22 x 1.5	10	9.5	100	6	124	84			160		160	
VDHB16S	16	12	24 x 1.5	11	9.5	100	6	124	83			160		160	
VDHB20S	20	16	30 x 2	13	11.0	100	6	124	79			160		160	
VDHB25S	25	20	36 x 2	17	12.0	125	9	153	106			160		160	

Note: Weld fitting. Omit "A3C" in the part number for stainless steel material.
For EO-2 part number, insert "Z" between size and pressure series.
Example: VDHB06ZS

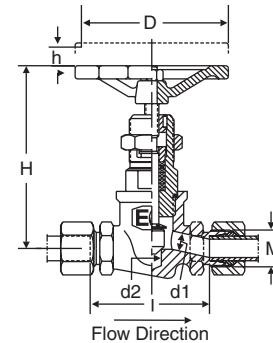

External threaded spindle and body of forged stainless steel

KH Full Dimensions

Two-Way Ball Valve
24° Flareless / 24° Flareless

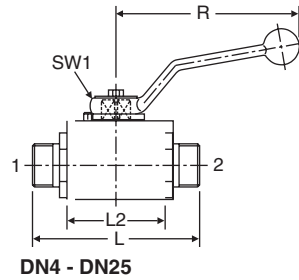

DN4 - DN25

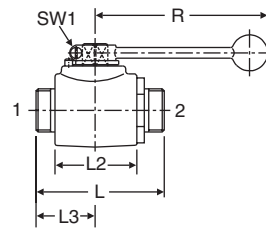

DN32 - DN40



TUBE FITTING PART #	END SIZE 1 & 2 (mm)	DN SIZE (mm)	B (mm)	h1 (mm)	h2 (mm)	H (mm)	L (mm)	L2 (mm)	L3 (mm)	R (mm)	SW1 (mm)	STANDARD Pressure Rating (bar)				
												EO			EO-2	
												A3C	71	MS	A3C	71
KH06L	6	4	20	10.0	55.0	25	67	36	—	76	7	125	125		125	125
KH08L	8	6	20	10.0	55.0	25	67	36	—	76	7	125	125		125	125
KH10L	10	8	30	14.5	68.0	35	75	45	—	100	8	125	125		125	125
KH12L	12	10	30	14.5	68.0	35	75	45	—	100	8	125	125		125	125
KH15L	15	12	35	17.0	92.0	40	83	51	—	112	10	125	125		125	125
KH18L	18	16	45	20.0	105.0	45	82	50	—	166	11	125	125		125	125
KH22L	22	20	45	24.0	113.0	55	99	60	—	187	14	63	63		63	63
KH28L	28	25	55	26.0	118.0	60	108	70	—	187	14	63	63		63	63
KH35L	35	32	73	36.5	104.5	80	121	79	58.5	240	17	63	63		63	63
KH42L	42	40	85	42.5	114.5	90	118	76	52.5	240	17	63	63		63	63
KH08S	8	4	20	10.0	55.0	25	73	36	—	76	7	200	200		200	200
KH10S	10	6	20	10.0	55.0	25	73	36	—	76	7	200	200		200	200
KH12S	12	8	30	14.5	68.0	35	77	45	—	100	8	200	200		200	200
KH14S	14	10	30	14.5	68.0	35	81	45	—	100	8	200	200		200	200
KH16S	16	12	35	17.0	92.0	40	87	51	—	112	10	160	160		160	160
KH20S	20	16	40	20.0	105.0	45	90	50	—	166	11	160	160		160	160
KH25S	25	20	45	24.0	113.0	55	107	60	—	187	14	125	125		125	125
KH30S	30	25	55	36.0	118.0	60	120	70	—	187	14	125	125		125	125
KH38S	38	32	73	36.5	104.5	80	127	73	58.5	240	17	125	125		125	125

For EO-2 part number, insert "Z" between size and pressure series.
Example: KH08ZSA3C

KH-R/NPT Full Dimensions

Two-Way Ball Valve
 Female BSPP / Female BSPP
 Female NPT / Female NPT

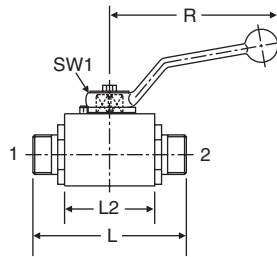

DN4 - DN25

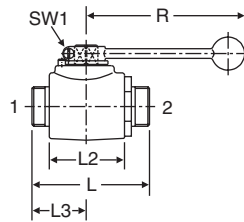

DN32 - DN40



TUBE FITTING PART #	END SIZE 1 & 2 NPT / BSPT	DN SIZE (mm)	B (mm)	h1 (mm)	h2 (mm)	H (mm)	L (mm)	L2 (mm)	L3 (mm)	R (mm)	SW1 (mm)	STANDARD Pressure Rating (bar)		
												EO		
												A3C	71	MS
KH1/8X	1/8-28	4	20	10.0	55.0	25	69	36	—	76	7	200	200	
KH1/4X	1/4-19	6	20	10.0	55.0	25	69	36	—	76	7	200	200	
KH3/8X	3/8-19	10	30	14.5	68.0	35	73	45	—	100	8	200	200	
KH1/2X	1/2-14	12	35	17.0	92.0	40	82	51	—	112	10	200	200	
KH5/8X	5/8-14	16	40	20.0	105.0	45	88	50	—	166	11			
KH3/4X	3/4-14	20	45	24.0	113.0	55	93	60	—	187	14	125	125	
KH1X	1-11	25	55	26.0	118.0	60	113	70	—	187	14	125	125	
KH11/4X	1 1/4-11	32	73	36.5	104.5	80	110	70	58.5	240	17	195	195	
KH11/2X	1 1/2-11	40	85	42.5	114.5	90	114	75	57.0	240	17	195	195	
KH1/8NPTX	1/8-27	4	20	10.0	55.0	25	69	36	—	76	7	200		
KH1/4NPTX	1/4-18	6	20	10.0	55.0	25	69	36	—	76	7	200		
KH3/8NPTX	3/8-18	10	30	14.5	68.0	35	73	45	—	100	8	200		
KH1/2NPTX	1/2-14	12	35	17.0	92.0	40	82	51	—	112	10	200		
KH3/4NPTX	3/4-14	20	45	24.0	113.0	55	93	60	—	187	14	125		
KH1NPTX	1-11 1/2	25	55	26.0	118.0	60	113	70	—	187	14	125		
KH11/4NPTX	1 1/4-11 1/2	32	73	36.5	104.5	80	110	70	58.5	240	17	125		
KH11/2NPTX	1 1/2-11 1/2	40	85	42.5	114.5	90	114	75	57.0	240	17	125		

WV Full Dimensions

Alternating Valve
 24° Flareless

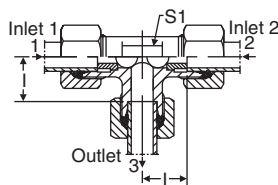

TUBE FITTING PART #	END SIZE 1 - 3 (mm)	I (mm)	S1 (mm)	STANDARD Pressure Rating (bar)		
				EO		
				A3C	71	MS
WV08L	8	14	14	160		
WV10L	10	15	17	160		
WV12L	12	17	19	160		
WV15L	15	21	19	160		

