

Linear DC-Servomotors

with Analog Hall Sensors
QUICKSHAFT® Technology

3,6 N

For combination with
Drive Electronics:
Motion Controller

Series LM 1247 ... 11

	LM 1247-	020-11	040-11	060-11	080-11	100-11	120-11	
1 Continuous force ¹⁾	$F_e \text{ max.}$	3,6						N
2 Peak force ^{1) 2)}	$F_p \text{ max.}$	10,7						N
3 Continuous current ¹⁾	$I_e \text{ max.}$	0,55						A
4 Peak current ^{1) 2)}	$I_p \text{ max.}$	1,66						A
5 Back-EMF constant	k_E	5,25						V/m/s
6 Force constant ³⁾	k_F	6,43						N/A
7 Terminal resistance, phase-phase	R	13,17						Ω
8 Terminal inductance, phase-phase	L	820						μH
9 Stroke length	s_{max}	20	40	60	80	100	120	mm
10 Repeatability ⁴⁾		40	40	40	40	40	40	μm
11 Precision ⁴⁾		120	140	160	180	200	220	μm
12 Acceleration ⁵⁾	$a_e \text{ max.}$	198,0	148,5	127,3	101,8	91,4	82,9	m/s^2
13 Speed ^{5) 6)}	$v_e \text{ max.}$	2,0	2,4	2,8	2,9	3,0	3,2	m/s
14 Thermal resistance	R_{th1} / R_{th2}	3,2 / 20,0						K/W
15 Thermal time constant	τ_{w1} / τ_{w2}	11 / 624						s
16 Operating temperature range		- 20 ... +125						$^{\circ}\text{C}$
17 Rod weight ⁷⁾	m_m	18	24	28	35	39	43	g
18 Total weight ⁷⁾	m_t	57	63	67	74	78	82	g
19 Magnetic pitch	τ_m	18						mm
20 Rod bearings		polymer sleeves						
21 Housing material		metal, non-magnetic						
22 Direction of movement		electronically reversible						

¹⁾ thermal resistance R_{th2} by 55% reduced

²⁾ for max. 1 second with a duty cycle of 10%

³⁾ with sine wave commutation

⁴⁾ typical values with integrated linear Hall sensors and Motion Controller.

The values depend on conditions of use

⁵⁾ theoretical value, referring only to the motor

⁶⁾ with a triangular speed profile and the max. stroke

⁷⁾ rounded value, for reference only

Notes: These motors are for operation with DC-voltage < 75 V DC.

The given values are for free standing motors.

The mounting with magnetic conductive metal can influence the characteristics of the motor.

Caution: Presence of strong magnetic fields. Static sensitive device.

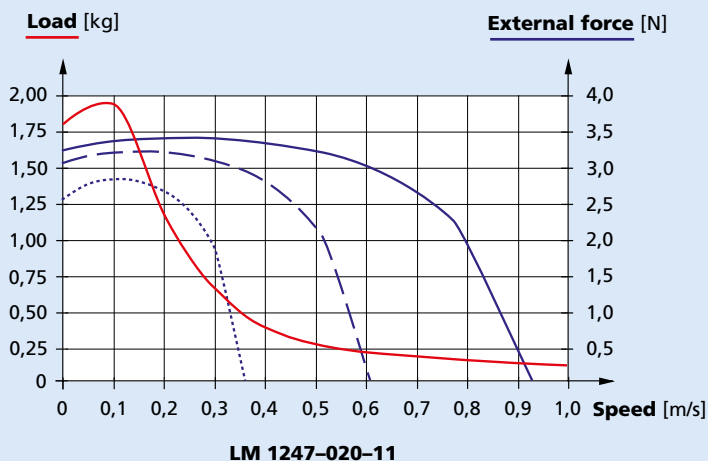

Trapezoidal motion profile ($t_1 = t_2 = t_3$)

Displacement distance:	20 mm
Friction coefficient:	0,2
Slope angle:	0°
Rest time:	0,1 s

Load: The max. permissible load at a given speed with an external force of 0 N

External force: The max. permissible external force at a given speed with a load of:

- 0,1 Kg —————
- 0,2 Kg - - - - -
- 0,5 Kg ·········

Linear DC-Servomotor LM 1247 ... 11 with axial connection

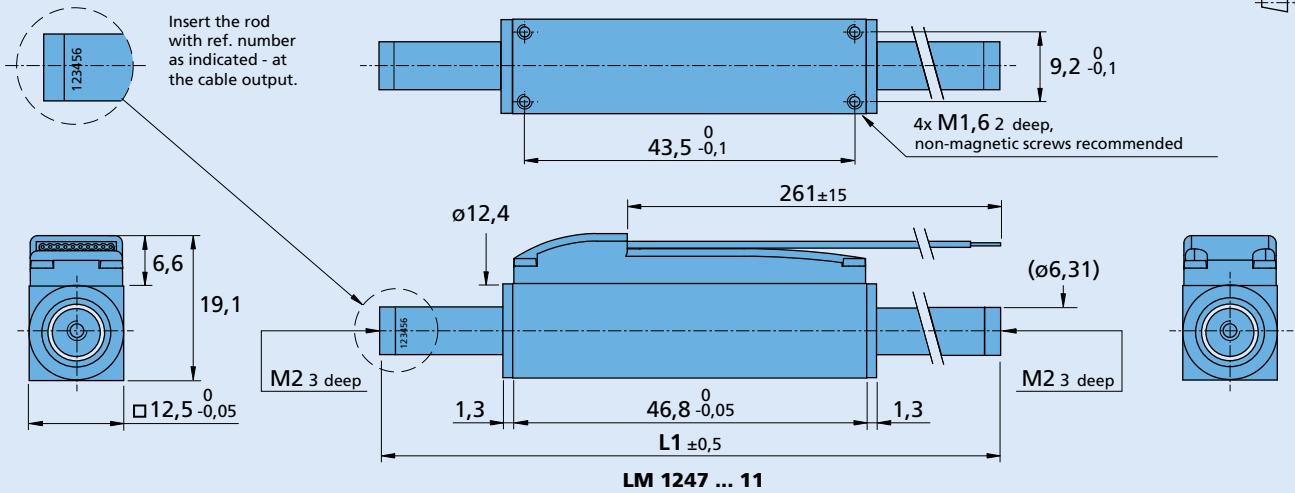

Ordering information

Linear DC-Servomotors Series

Series	Stroke mm	Rod length L1 ± 0,5 mm
LM 1247-020-11	-10 to +10	82
LM 1247-040-11	-20 to +20	109
LM 1247-060-11	-30 to +30	127
LM 1247-080-11	-40 to +40	154
LM 1247-100-11	-50 to +50	172
LM 1247-120-11	-60 to +60	190

Note: Single rod available on request.

Cable and connection information

Cable for LM 1247-...-11C

Material PVC, 10 conductors, AWG 28 with connector A05a - TCO, pitch 2 mm

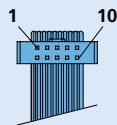
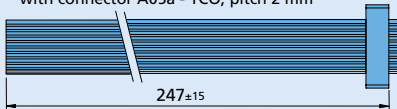

Cable for LM 1247-...-11

Material PVC, 10 conductors, AWG 28, grid 1mm, wires tinned

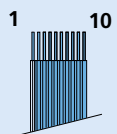
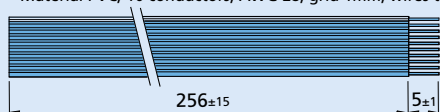

Cable for LM 1247-...-01

Single wires, material PVC, 10 conductors, AWG 28. Recommended connector: Molex - Nr. 51110-1060

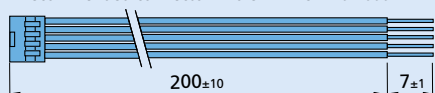

* The color reference refers only to the LM 1247-...-01 version.

Adapter for LM 1247-...-11C

for connection with Motion Controllers MCLM 3006 S RS/CF (part no. 6501.00182). MCLM 3002 S RS/CF (part no. 6501.00171).

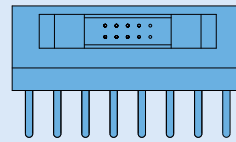

Connection LM 1247-...-01

PIN	Function	Color*
1	Phase C	yellow
7	Phase B	orange
8	Phase A	brown
4	GND	black
3	+5V	red
6	Hall sensor C	grey
5	Hall sensor B	blue
2	Hall sensor A	green
9	N.C.	white
10	N.C.	purple

LM 1247-...-11 / 11C

PIN	Function
1	Phase C
2	Phase B
3	Phase A
4	GND
5	+5V
6	Hall sensor C
7	Hall sensor B
8	Hall sensor A
9	N.C.
10	N.C.