



2-Color Display Type  
High-Precision Digital Pressure Switch

# Series **ZSE30/ISE30**



Improved, easy-to-read 2-color display

# 2-Color Display Type High-Precision Digital Pressure Switch

## Series ZSE30/ISE30



*2-color digital display allows you to choose the setting according to your application requirements. 4 different display settings are available.*

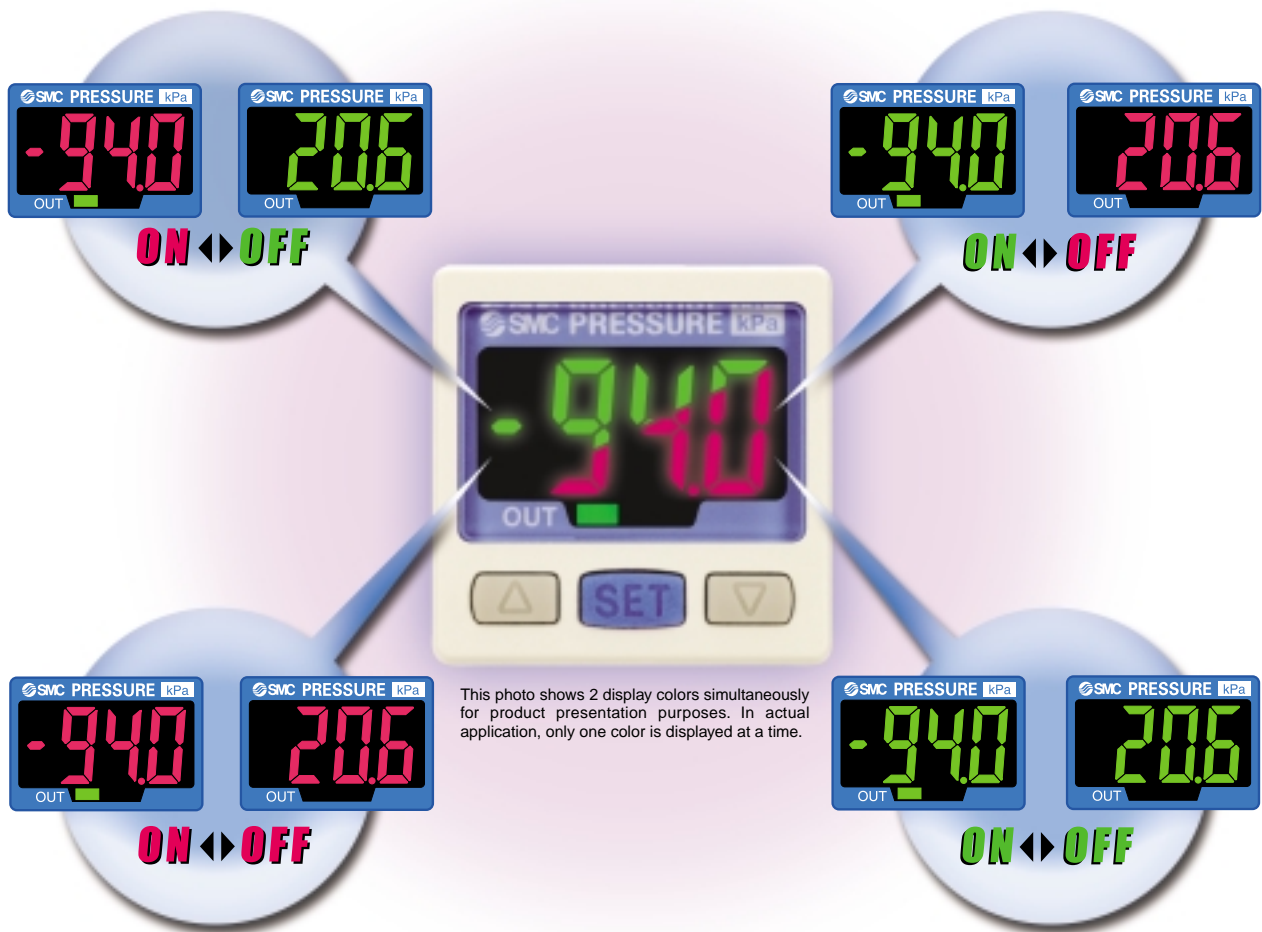

**Abnormal conditions can be detected at a glance!**

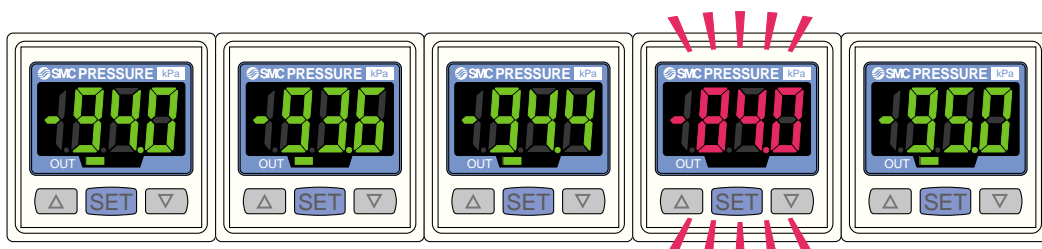

# Space-saving improvement

Economical use of space

## Old Model

ZSE4E  
ISE4E

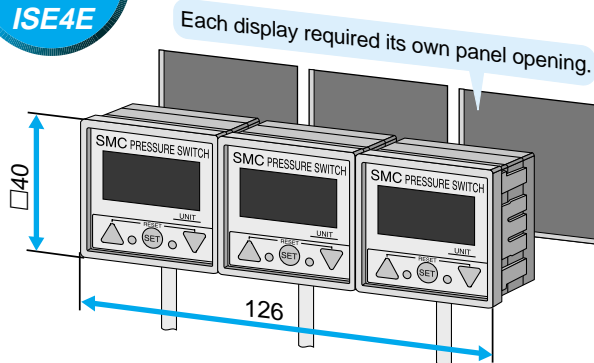

## New Model

ZSE30  
ISE30

Just one panel opening is required for stackable displays, which can be mounted either horizontally or vertically.

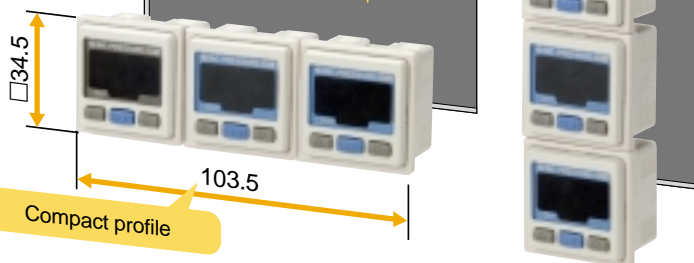

## Applicable panel thickness is up to 6mm.

(Panel mounting)

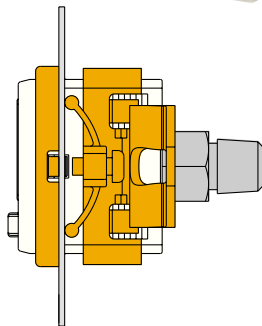

## With analog output

In addition to the conventional voltage output type (1 to 5V)

### Current output type (4 to 20mA)

is now available.

- Convenient when longer wiring is required
- Excellent noise resistance

## Switches for vacuum and positive pressure can be easily distinguished.

The different display panel frame colors easily tell them apart.

Vacuum/Low pressure (ZSE30)

Blue



Positive pressure (ISE30)

Gray



## Display calibration

### Old Model

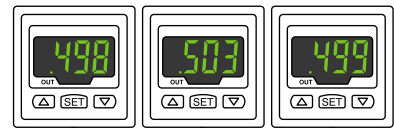

### New Model

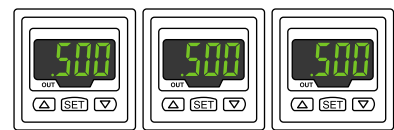

This function allows uniformity in the numbers displayed.

## More user-friendly controls

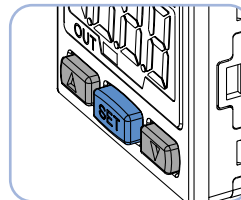

Raised rubber button controls are clearly set apart, simple to operate, soft to the touch.

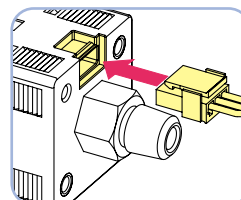

Plug-type connectors take the burden out of wiring work and maintenance.

## High-precision resolution: 1/1000

## Variations

	Vacuum/Low pressure ZSE30	Positive pressure ISE30	
Rated pressure range	100kPa 0 -100kPa	1MPa 0	
	Setting/Display resolution		
Setting/Display resolution	0.2kPa	0.001MPa	
Output	Switch output	NPN/PNP open collector (1 output)	
	Analog output	Voltage output: 1 to 5V; Current output: 4 to 20mA	
Current consumption	45mA or less (70mA or less for current output)		
Option	Panel mount/Bracket		

# 2-Color Display Type High-Precision Digital Pressure Switch Series **ZSE30/ISE30**

## How to Order

### Option 1

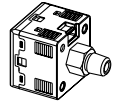
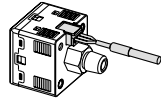
Nil	Without lead wire 
L	Lead wire with connector (Lead wire length: 2m) 

For positive pressure

**ISE30** — **01** — **25** — **M** — [ ] — [ ]

For vacuum/Low pressure

**ZSE30** — **01** — **25** — **M** — [ ] — [ ]

### Piping specification

<b>01</b>	R 1/8 (with M5 female thread)
<b>T1</b>	NPT 1/8 (with M5 female thread)

### Output specification

<b>25</b>	NPN output
<b>65</b>	PNP output
<b>26</b>	1 to 5V output
<b>28</b>	4 to 20mA output

### Option 2

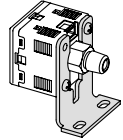
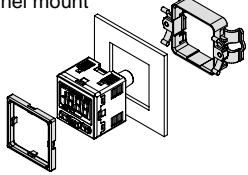
Nil	None
A	Bracket 
B	Panel mount 

### Unit specification

Nil	With unit switching function
M	Fixed SI unit (International System of Units) Note)

Note) Fixed units:  
For vacuum/Low pressure: kPa  
For positive pressure: MPa

## Optional Part Nos.

When optional parts are required separately, use the following part numbers to place an order.

Option	Part no.	Note
Lead wire with connector	ZS-27-A	Lead wire length: 2m
Bracket	ZS-27-B	With mounting screws (M3 x 5L: 2 pcs.)
Panel mount adapter	ZS-27-C	

## Specifications



	ZSE30	ISE30															
Rated pressure range	-100 to 100kPa	0 to 1MPa															
Regulating pressure range	-101 to 101kPa	-0.1 to 1MPa															
Proof pressure	500kPa	1.5MPa															
Setting/Display resolution	0.2kPa	0.001MPa															
Fluid	Air, Inert gas, Non-flammable gas																
Power supply voltage	12 to 24VDC $\pm 10\%$ , Ripple (p-p) 10% or less (with power supply polarity protection)																
Current consumption	45mA or less (70mA or less for current output)																
Switch output <sup>Note 1)</sup>	NPN or PNP open collector output: 1 output																
<table border="1" style="width: 100%; border-collapse: collapse;"> <tr> <td style="width: 30%;"><b>Max. load current</b></td> <td colspan="2">80mA</td> </tr> <tr> <td><b>Max. applied voltage</b></td> <td colspan="2">30V (with NPN output)</td> </tr> <tr> <td><b>Residual voltage</b></td> <td colspan="2">1V or less (with load current of 80mA)</td> </tr> <tr> <td><b>Response time</b></td> <td colspan="2">2.5ms or less (Response time selections with anti-chattering function: 20ms, 160ms, 640ms, 1280ms)</td> </tr> <tr> <td><b>Short circuit protection</b></td> <td colspan="2">With short circuit protection</td> </tr> </table>	<b>Max. load current</b>	80mA		<b>Max. applied voltage</b>	30V (with NPN output)		<b>Residual voltage</b>	1V or less (with load current of 80mA)		<b>Response time</b>	2.5ms or less (Response time selections with anti-chattering function: 20ms, 160ms, 640ms, 1280ms)		<b>Short circuit protection</b>	With short circuit protection			
	<b>Max. load current</b>	80mA															
	<b>Max. applied voltage</b>	30V (with NPN output)															
	<b>Residual voltage</b>	1V or less (with load current of 80mA)															
	<b>Response time</b>	2.5ms or less (Response time selections with anti-chattering function: 20ms, 160ms, 640ms, 1280ms)															
<b>Short circuit protection</b>	With short circuit protection																
Repeatability	$\pm 0.2\%$ F.S. $\pm 2$ digits or less	$\pm 0.2\%$ F.S. $\pm 1$ digit or less															
Analog output	<sup>Note 2)</sup> <b>Voltage output</b> Output voltage: 1 to 5V $\pm 2.5\%$ F.S. or less (with rated pressure range) Linearity: $\pm 1\%$ F.S. or less; Output impedance: Approx. 1k $\Omega$																
	<sup>Note 3)</sup> <b>Current output</b> Output current: 4 to 20mA; $\pm 2.5\%$ F.S. or less (with rated pressure range) Linearity: $\pm 1\%$ F.S. or less Maximum load impedance: 300 $\Omega$ with power supply voltage of 12V; 600 $\Omega$ with power supply voltage of 24V Minimum load impedance: 50 $\Omega$																
Hysteresis	<b>Hysteresis mode</b>																
	<b>Window comparator mode</b>																
Display	3 1/2-digit, 7-segment indicator, 2-color display (red and green) Sampling cycle: 5 times/s																
Display accuracy	$\pm 2\%$ F.S. $\pm 2$ digits (25°C)	$\pm 2\%$ F.S. $\pm 1$ digit (25°C)															
Indication light	Lights up when output is ON (Green)																
Temperature characteristics	$\pm 2\%$ F.S. or less (based on 25°C)																
Enclosure	IP40																
Ambient temperature range	Operating: 0° to 50°C; Stored: -10° to 60°C (with no freezing or condensation)																
Ambient humidity range	Operating and stored: 35 to 85% RH (with no condensation)																
Withstand voltage	1000VAC for 1 min. between live parts and enclosure																
Insulation resistance	50M $\Omega$ or more between live parts and enclosure (at 500VDC)																
Vibration resistance	10 to 150Hz, 1.5mm amplitude in X, Y, Z directions for 2 hours each																
Impact resistance	100m/s <sup>2</sup> in X, Y, Z directions 3 times each																
Port size	O1 type: R 1/8, M5 x 0.8; T1 type: NPT 1/8, M5 x 0.8																
Material	Front case: PBT; Rear case: PBT; Piping port: C3602 (electroless nickel plated) Sensor pressure: Silicon; O-ring: NBR																
Weight	43g (without lead wire)																

Note 1) When switch output is selected, analog output is not available.

Note 2) When voltage output is selected, a simultaneous selection of switch output and current output is not available.

Note 3) When current output is selected, a simultaneous selection of switch output and voltage output is not available.

## Setting

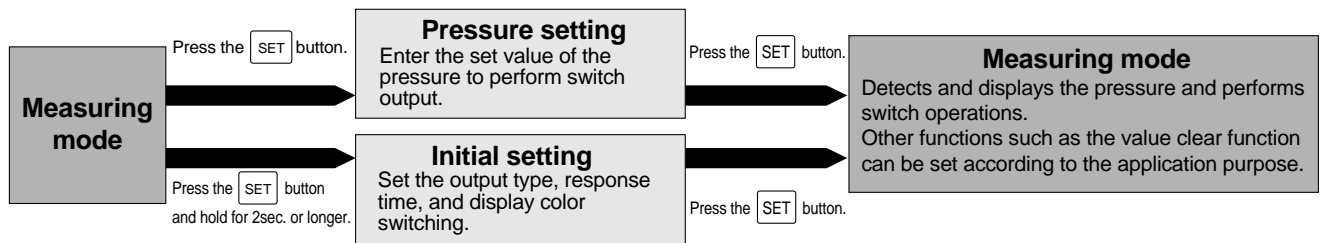

### Initial Setting

#### Initial setting mode

Press and hold the SET button for 2 seconds or longer. Display monitor will be per Figure A below, and the switch will now be in the display color setting mode.

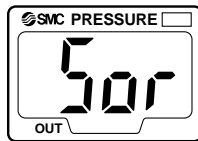
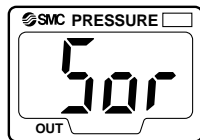

Figure A

If the unit specification indicated at the time of ordering is "M", the fixed SI unit will be used. If it is Nil, refer to "Unit Switching Function" on page 5.

#### 1. Display color setting

Select the color for LCD display. Press the  $\Delta$ UP or  $\nabla$ DOWN button to choose a display color.



ON: Red

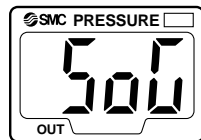

ON: Green

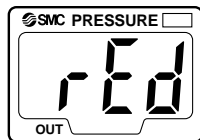

ON/OFF: Red

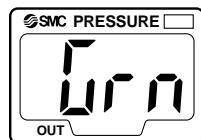

ON/OFF: Green

Press the SET button to set the color and proceed to the operating mode setting.

If the analog output is set, press the  $\Delta$ UP or  $\nabla$ DOWN button and select the desired display color from Grn (Green) or rEd (Red). Press the SET button to exit this mode and return to the measuring mode.

#### 2. Operating mode setting

This mode will let you select the switch operating mode. While the current operating mode is displayed, press the  $\Delta$ UP or  $\nabla$ DOWN button to select a newly desired operating mode.

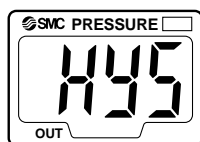

Hysteresis mode

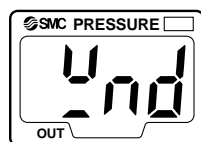

Window comparator mode

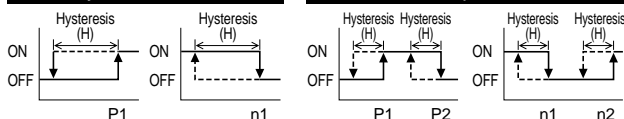

(Standard: Factory setting) (Reversed)

(Standard: Factory setting) (Reversed)

Press the SET button to set the mode and proceed to the output type setting.

#### 3. Output type setting

The type of switch output can be set arbitrarily. While the current output type is displayed, press the  $\nabla$ DOWN button to switch between normally open  $nO$  and normally closed  $nL$ .

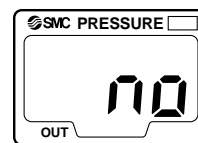

Normally open

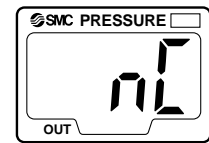

Normally closed

Press the SET button to set the output type and proceed to the response time setting.

#### 4. Response time setting

The switch output response time can be set arbitrarily. Chattering can be prevented with a response time setting. While the current response time is displayed, press the  $\Delta$ UP or  $\nabla$ DOWN button to select a new response time.

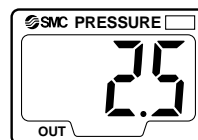

2.5ms

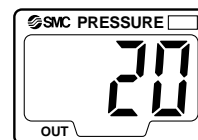

20ms



160ms

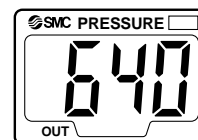

640ms



1280ms

Press the SET button to set the response time and proceed to the auto preset setting.

If the operating mode is the window comparator mode, press the SET button to return to the measuring mode.

#### 5. Auto preset setting

This function stores the measuring pressure that is set during the auto preset mode as a basic value.

While the current setting is displayed, press the  $\Delta$ UP or  $\nabla$ DOWN button to select it as an auto preset setting.



Manual

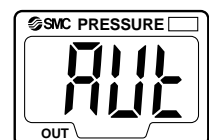

Auto

Press the SET button to set the auto preset and return to the measuring mode.

## Pressure setting

### Manual setting

Press the SET button in the measuring mode to display the set value.  $P_{-} I$  and the current set value blink alternately.

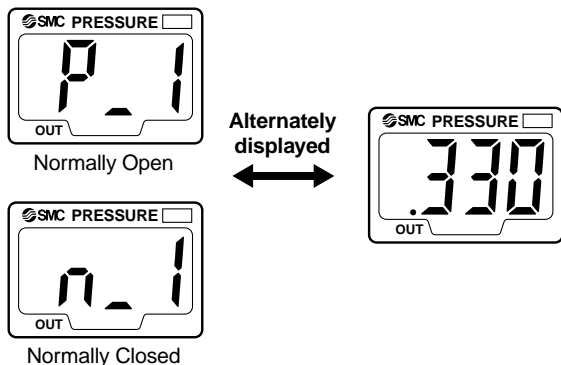

Press the SET button to display the next set value. Press the  $\Delta$ UP or  $\nabla$ DOWN button to change the value. (Refer to "How to Set Value" on the lower right hand corner of this page.)

### Hysteresis mode

In this mode, hysteresis (H) and the set value for hysteresis are displayed alternately after setting P1. Press the SET button to return to the normal measuring mode. Press the  $\Delta$ UP or  $\nabla$ DOWN button to change the value. (Refer to "How to Set Value" below right.)

### Window comparator mode

In this mode, P2 and the current set value are displayed alternately after setting P1. Press the SET button to display the next set value (H: hysteresis). Press the  $\Delta$ UP or  $\nabla$ DOWN button to change the value. (Refer to "How to Set Value" at right.)

Next, H and the set value for hysteresis will be displayed alternately. Press the SET button to return to the normal measuring mode. Press the  $\Delta$ UP or  $\nabla$ DOWN button to change the value. (Refer to "How to Set Value" at right.)

Pressure set value can be verified without holding or stopping the switch output operation.

## Auto preset setting

### 1. Auto preset preparation mode

While in the measuring mode, press the SET button to activate the auto preset preparation mode, and  $AP I$  will be displayed. Proceed to prepare the devices to perform the pressure setting. While  $AP I$  is still displayed, press both the  $\Delta$ UP and  $\nabla$ DOWN buttons simultaneously to return to the measuring mode.

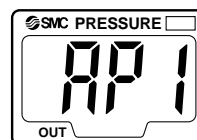

### 2. Auto preset setting

Press the SET button to activate the mode to execute auto preset functions. When  $AI$  is displayed, start the system operation and change the pressure. The set value will be automatically detected and stored.

While  $AI$  is still displayed, press the SET button to complete the setting and return to the normal measuring mode.

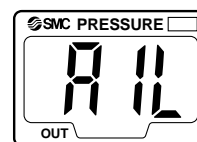

### How to Set Value

To enter a value such as the one for pressure setting:

1. Press the  $\Delta$ UP or  $\nabla$ DOWN button to change the set value. The first digit blinks.



1st digit

2. Press the  $\Delta$ UP or  $\nabla$ DOWN button to set the value arbitrarily. (If there is no button operation for more than 10 seconds, the current value will be automatically set and the function will return to the set value display mode.)

3. With every push of the SET button, the next (higher) digit blinks.



2nd digit



3rd digit

When the left-most digit is zero, "i" or "j" will blink. If the SET button is pressed while the left-most digit is blinking, the right-most digit will now blink.



4. Press and hold the SET button for 1 second or longer to return to the set value display mode.

## Setting

### Function setting

#### Display calibration

During measuring mode, press the SET and  $\nabla$ DOWN buttons simultaneously and hold for 2 seconds or longer.  $F5\%L$  and current measured value will be displayed.

Press the  $\Delta$ UP or  $\nabla$ DOWN button to change the set value. If there is no button operation for more than 2 seconds after changing the set value, the display mode returns to displaying  $F5\%L$  and the current measured value.

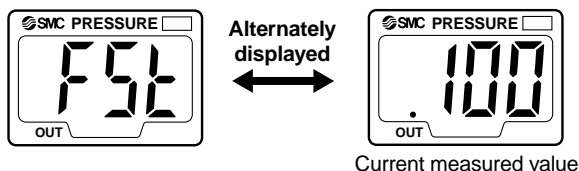

Press the SET button to display the adjusted value (percent). The adjusted value and  $F5\%L$  will be alternately displayed.

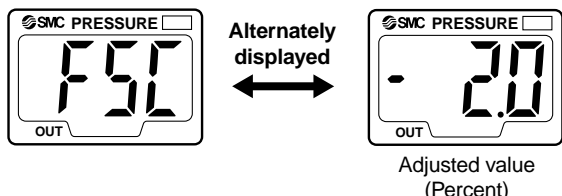

Press the SET button to return to the normal measuring mode.

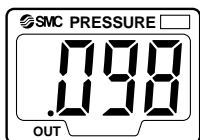

This function eliminates slight differences in the output values and allows uniformity in the numbers displayed. Displayed values of the pressure sensor can be calibrated to within  $\pm 5\%$  for Series ISE and  $\pm 2.5\%$  for Series ZSE.

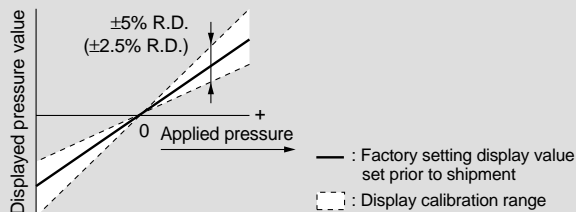

Note) When the display calibration function is used, the regulating pressure value may change  $\pm 1$  digit.

#### Peak/Bottom hold function

This function constantly detects and updates the maximum and minimum pressure values and allows to hold the display value. To use a peak hold function, press and hold the  $\Delta$ UP button for 1 second or longer. The maximum pressure value is held and blinks repeatedly. Press and hold the  $\Delta$ UP button again for 1 second or longer to release this function and return to the measuring mode.

To use a bottom hold function, press the  $\nabla$ DOWN button for 1 second or longer. The minimum pressure value is held and blinks repeatedly. Press and hold  $\nabla$ DOWN button again for 1 second or longer to release this function and return to the measuring mode.

#### Key lock function

This function prevents incorrect operations such as changing the set value accidentally. Press the SET button and hold for 4 seconds or longer to display the current  $Loc$  or  $Unl$  setting. Press the  $\Delta$ UP or  $\nabla$ DOWN button to select the setting and set this function with the SET button. Use the  $Loc$  mode to avoid accidental button operation. To release a key lock function, press the SET button and hold for 4 seconds or longer to display the current setting, and select the  $Unl$  mode.

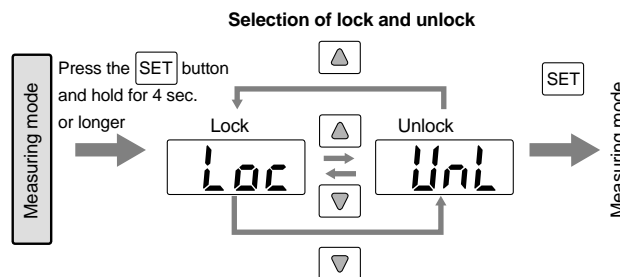

#### Zero out (Zero ADJ) function

This function clears and resets the displayed value as long as the measuring pressure is within  $\pm 70$  digits of the atmospheric pressure.

(Due to individual product differences, the setting range varies  $\pm 10\%$  F.S.)

This function is effective in detecting pressure fluctuations that exceed a certain amount without being affected by the supply pressure. Press and hold the  $\Delta$ UP and  $\nabla$ DOWN buttons simultaneously to reset the display. Release the buttons to return to the measuring mode.

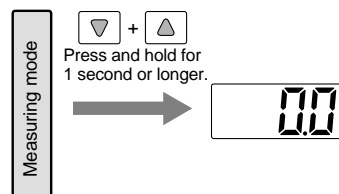

#### Unit Conversion Function

##### When not selecting "M" for unit specification

Desired display unit can be selected.

Press the  $\Delta$ UP or  $\nabla$ DOWN button to switch the unit, and the set value is automatically converted.

The conversion order is: Pa $\leftrightarrow$ kgf/cm $^2$  $\leftrightarrow$ bar $\leftrightarrow$ psi $\leftrightarrow$ inchHg $\leftrightarrow$ mmHg

Press the SET button to set the unit and proceed to the display color setting.

**For vacuum/low pressure** Pa $\leftrightarrow$ kgf/cm $^2$  $\leftrightarrow$ bar $\leftrightarrow$ psi $\leftrightarrow$ inchHg $\leftrightarrow$ mmHg

**For positive pressure** MPa $\leftrightarrow$ kgf/cm $^2$  $\leftrightarrow$ bar $\leftrightarrow$ psi

##### Indication of units

Displayed units	ISE30	ZSE30
Pa	0.001MPa	0.2kPa
kgf/cm $^2$	0.01	0.002
bar	0.01	0.002
psi	0.2	0.05
mmHg	—	2
inchHg	—	0.2



## Description

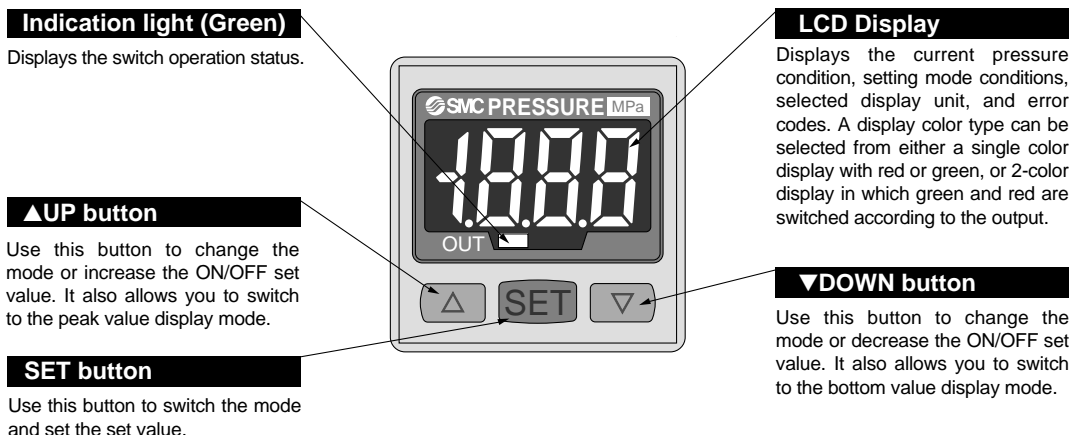

## Error Correction

Take the following corrective solutions when errors occur.

Error description	LCD display	Condition	Solution
over-current error	Er1	Load current of switch output is more than 80mA.	Shut off the power supply. After eliminating the output factor that caused the excess current, turn the power supply back on.
Residual pressure error	Er3	Pressure is applied during the zero out operation as follows: When the switch for positive pressure is used: $\pm 0.071\text{MPa}$ or more. When the switch positive pressure is used: $\pm 7.1\text{kPa}$ or more. After displaying for 3 seconds, it will return to the measuring mode. Due to the individual product difference, the setting range varies $\pm 10\%$ F.S.	Bring the pressure back to atmospheric pressure and try using the zero out function.
Applied pressure error	HHH	Supply pressure exceeds the maximum regulating pressure.	Reduce/increase supply pressure to within the regulating pressure range.
	LLL	Supply pressure is below the minimum regulating pressure.	
System error	Er4	Internal data error	Shut off the power supply. Turn the power supply back on. If the power should not come back on, please contact SMC for an inspection.
	Er6	Internal data error	
	Er7	Internal data error	
	Er8	Internal data error	

## Internal Circuit and Wiring Examples

**-25**  
**NPN open collector output**  
Maximum 30V, 80mA  
Residual voltage:  
1V or less

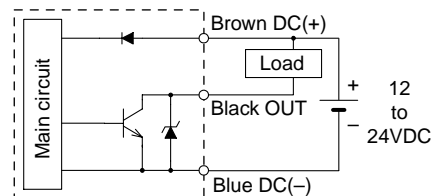

**-26**  
**Analog output type**  
1 to 5V ( $\pm 2.5\%$  F.S.)  
Output impedance:  
1k $\Omega$

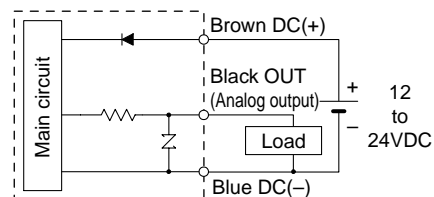

**-28**  
**Analog output type**  
4 to 20mA ( $\pm 2.5\%$  F.S.)  
Maximum load impedance:  
Power supply voltage 12V: 300 $\Omega$   
Power supply voltage 24V: 600 $\Omega$   
Minimum load impedance: 50 $\Omega$

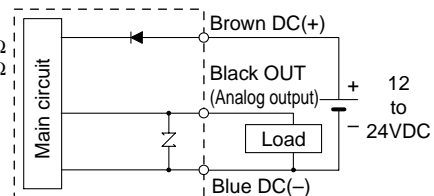

**-65**  
**PNP open collector**  
Maximum 80mA

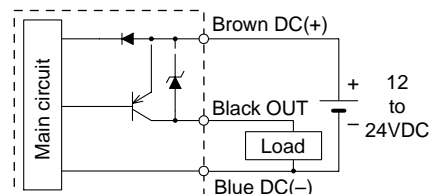

# Series ZSE30/ISE30

## Dimensions

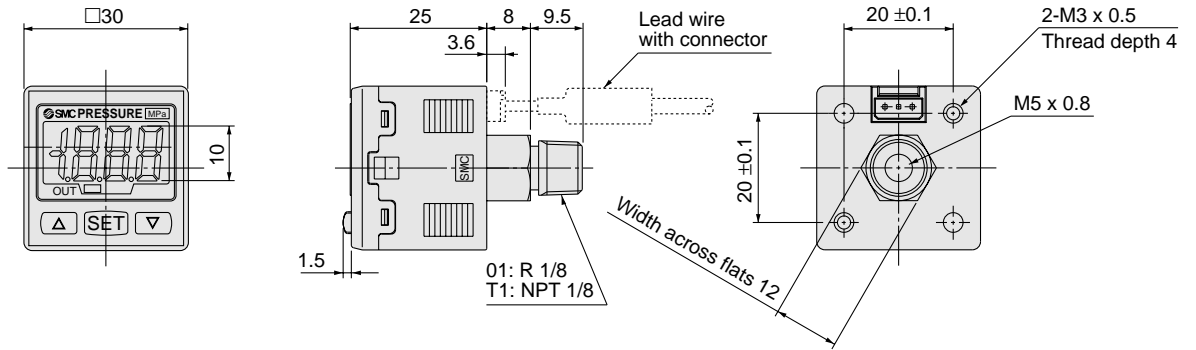

### With bracket

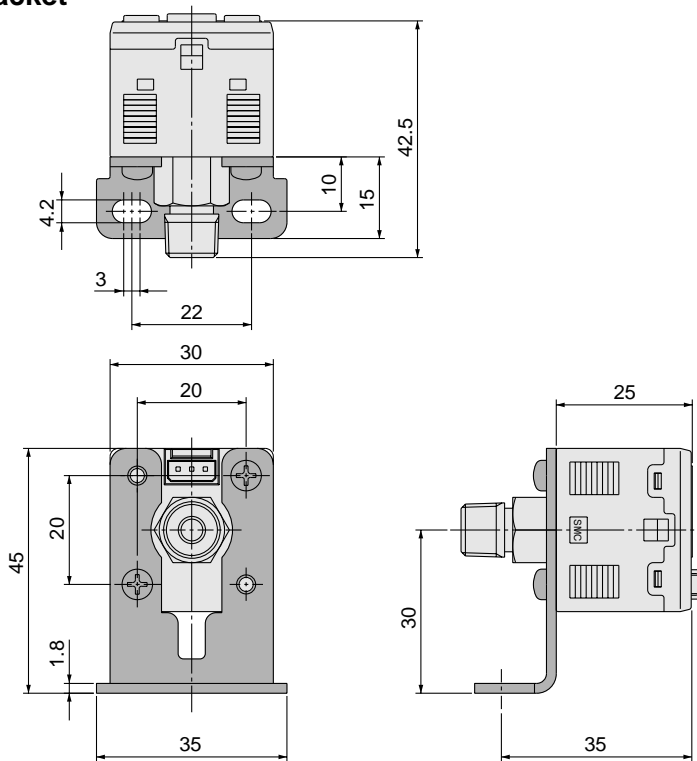

### Panel mount

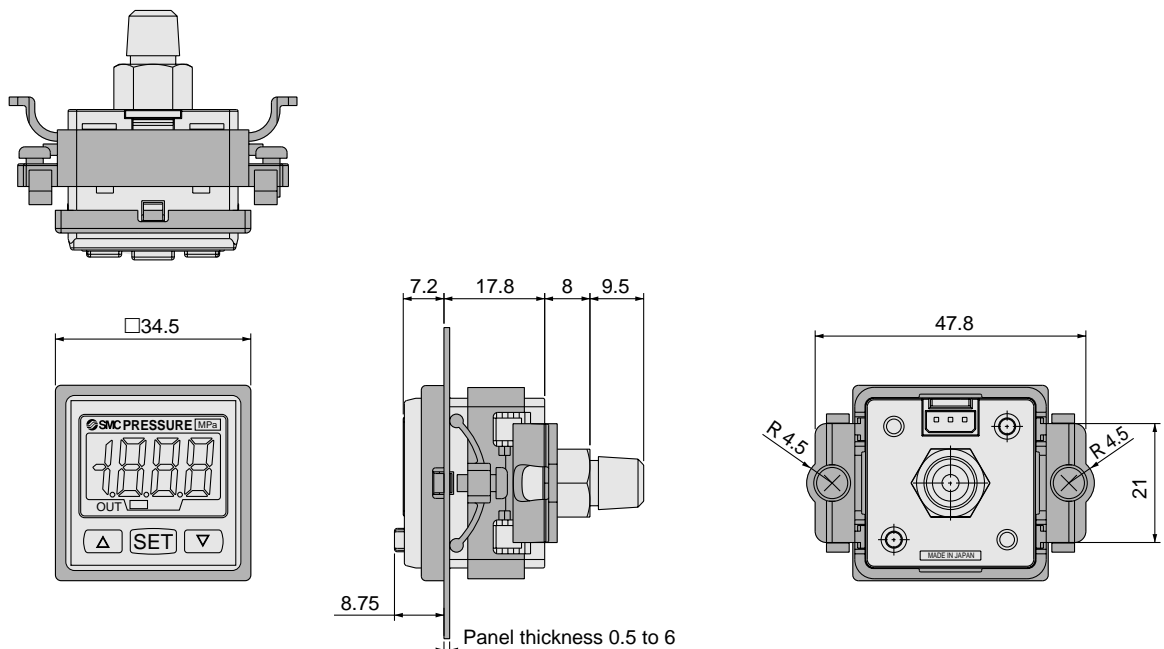

**Dimensions**

**Panel fitting dimension**

1-pc. mounting

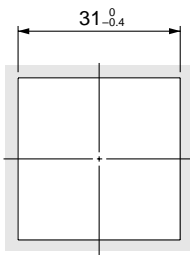

Multiple (2 pcs. or more) horizontal mounting

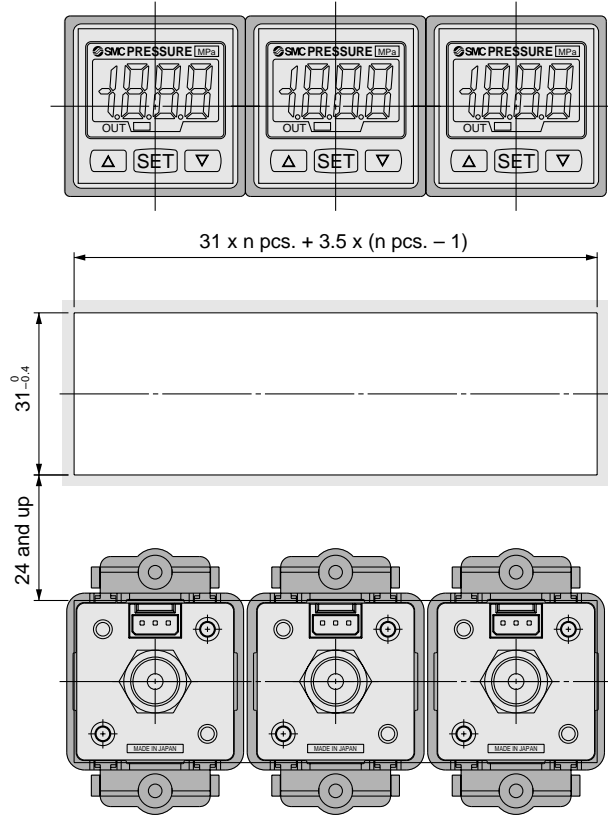

Multiple (2 pcs. or more) vertical mounting

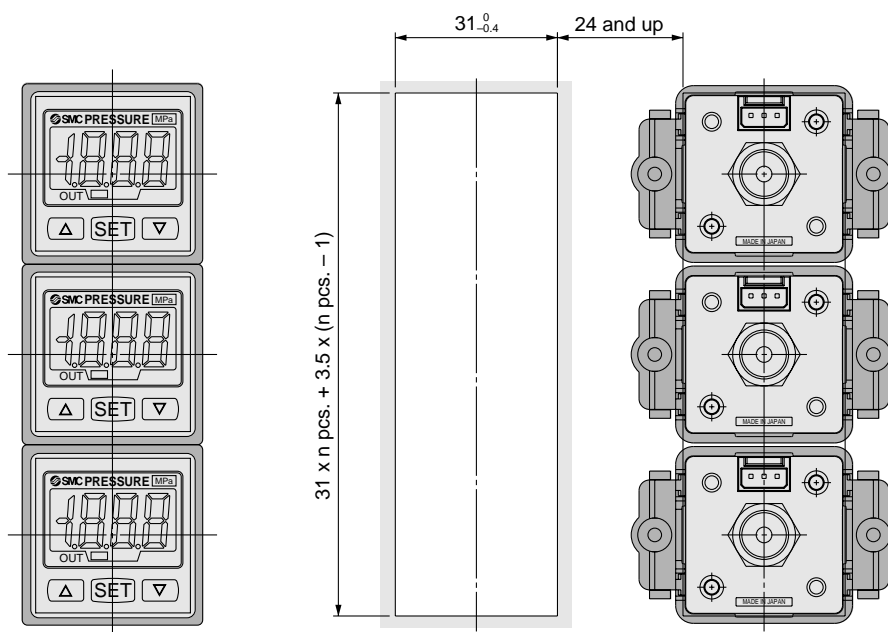



## Series ZSE30/ISE30

# Safety Instructions

These safety instructions are intended to prevent a hazardous situation and/or equipment damage. These instructions indicate the level of potential hazard by a label of "**Caution**", "**Warning**", or "**Danger**". To ensure safety, be sure to observe ISO 4414 Note 1), JIS B 8370 Note 2) and other safety practices.

**⚠ Caution** : Operator error could result in injury or equipment damage.

**⚠ Warning** : Operator error could result in serious injury or loss of life.

**⚠ Danger** : In extreme conditions, there is a possible result of serious injury or loss of life.

Note 1) ISO 4414: Pneumatic fluid power – Recommendations for the application of equipment to transmission and control systems

Note 2) JIS B 8370: General Rules for Pneumatic Equipment

### **⚠ Warning**

**1. The compatibility of pneumatic equipment is the responsibility of the person who designs the pneumatic system or decides its specifications.**

Since the products specified here are used in various operating conditions, their compatibility with the specific pneumatic system must be based on specifications or after analysis and/or tests to meet your specific requirements.

**2. Only trained personnel should operate pneumatically operated machinery and equipment.**

Compressed air can be dangerous if handled incorrectly. Assembly, handling or maintenance of pneumatic systems should be performed by trained and experienced operators.

**3. Do not service machinery/equipment or attempt to remove components until safety is confirmed.**

1. Inspection and maintenance of machinery/equipment should only be performed after confirmation of safe locked-out control positions.
2. When equipment is to be removed, confirm the safety process as mentioned above. Cut the supply pressure for this equipment and exhaust all residual compressed air in the system.
3. Before machinery/equipment is restarted, take measures to prevent shooting-out of cylinder piston rod, etc. (Bleed air into the system gradually to create back pressure.)

**4. Contact SMC if the product is to be used in any of the following conditions:**

1. Conditions and environments beyond the given specifications, or if product is used outdoors.
2. Installation on equipment in conjunction with atomic energy, railway, air navigation, vehicles, medical equipment, food and beverages, recreation equipment, emergency stop circuits, press applications, or safety equipment.
3. An application which has the possibility of having negative effects on people, property, or animals, and therefore requires special safety analysis.



# Series ZSE30/ISE30 Pressure Switch Precautions

Be sure to read before handling. Refer to pages 9 through 11 for safety instructions and pressure switch precautions, and to page 12 for specific product precautions.

## Design and Selection

### ⚠ Warning

#### 1. Operate the switch only within the specified voltage.

Use of the switch outside the range of the specified voltage can cause not only malfunction and damage of the switch but also electrocution and fire.

#### 2. Do not exceed the maximum allowable load specification.

A load exceeding the maximum load specification can cause damage to the switch or shorten its operating life span.

#### 3. Do not use a load that generates surge voltage.

Although surge protection is installed in the circuit at the output side of the switch, damage may still occur if a surge is applied repeatedly. When a surge generating load such as a relay or solenoid is directly driven, use a type of switch with a built-in surge absorbing element.

#### 4. Since the type of applicable fluid varies depending on the product, be sure to verify the specifications.

The switches do not have an explosion proof rating. To prevent a possible fire hazard, do not use with flammable gases or fluids.

#### 5. Operate the switch within the regulating pressure range and maximum operating pressure.

Malfunction can occur if the pressure sensor is used outside the regulating pressure range, and the sensor may be permanently damaged if used at a pressure that is above the maximum operating pressure.

## Mounting

### ⚠ Warning

#### 1. If the equipment is not operating properly, do not continue to use it.

Connect air and power after installation, repairs, or modifications, and verify proper installation. The switch should be checked for proper operation and possible leaks.

#### 2. Mount switches using the proper tightening torque.

When a switch is tightened beyond the specified tightening torque, the mounting screws, mounting bracket, or switch may be damaged. On the other hand, tightening below the specified tightening torque may cause the installation screws to come loose during operation.

Nominal thread sizes	Tightening torque
M5	1/6 rotation after tightening by hand
R 1/8, NPT 1/8	7 to 9 N·m

#### 3. Apply wrench only to the metal part of the main housing when installing the pressure switch onto the system piping.

Do not apply a wrench to the resin part as this may damage the switch.

## Wiring

### ⚠ Warning

#### 1. Verify the color and terminal number when wiring.

Incorrect wiring can cause the switch to be damaged and malfunction. Verify the color and the terminal number in the instruction manual when wiring.

#### 2. Avoid repeatedly bending or stretching the lead wire.

Repeatedly applying bending stress or stretching force to the lead wire will cause it to break. If you believe the lead wire is damaged and likely to cause malfunctions, replace it.

#### 3. Confirm proper insulation of wiring.

Make sure that there is no faulty wiring insulation (contact with other circuits, ground fault, improper insulation between terminals, etc.). Damage may occur due to excess current flow into a switch.

## Operating Environment

### ⚠ Warning

#### 1. Never use in the presence of explosive gases.

The switches do not have an explosion proof rating. Never use in the presence of an explosive gas as this may cause a serious explosion.

## Maintenance

### ⚠ Warning

#### 1. Perform periodic inspections to ensure proper operation of the switch.

Unexpected malfunctions may cause possible danger.

#### 2. Take precautions when using the switch for an interlock circuit.

When a pressure switch is used for an interlock circuit, devise a multiple interlock system to prevent trouble or malfunctioning. Verify the operation of the switch and interlock function on a regular basis.



# Series ZSE30/ISE30 Digital Pressure Switch Precautions

Be sure to read before handling. Refer to pages 9 through 11 for safety instructions and pressure switch precautions, and to page 12 for specific product precautions.

## Selection

### ⚠ Warning

#### 1. Monitor the internal voltage drop of the switch.

When operating below a specified voltage, it is possible that the load may be ineffective even though the pressure switch function is normal. Therefore, the formula below should be satisfied after confirming the minimum operating voltage of the load.

$$\text{Supply voltage} - \text{Internal voltage drop of switch} > \text{Minimum operating voltage of load}$$

### ⚠ Caution

#### 1. Data of the digital pressure switch will be stored even after the power is turned off.

Input data (set pressure, etc.) will be stored in EEPROM so that the data will not be lost after the pressure switch is turned off. (Data will be stored for up to 100,000 hours after the power is turned off.)

## Mounting

### ⚠ Warning

#### 1. Operation

Refer to the instruction manual for the operation of the digital pressure switch.

#### 2. Do not touch the LCD indicator.

Do not touch the LCD indicator face of the pressure switch during operation. Static electricity can change the readout.

#### 3. Pressure port

Do not introduce any wire or similar object to a pressure port as this may damage the pressure sensor and cause a malfunction.

## Wiring

### ⚠ Warning

#### 1. Do not wire in conjunction with power lines or high voltage lines.

Wire separately from power lines and high voltage lines, avoiding wiring in the same conduit with these lines. Control circuits including switches may malfunction due to noise from these other lines.

#### 2. Do not allow loads to short circuit.

Although digital pressure switches indicate excess current error if loads are short circuited, all incorrect wiring connections cannot be protected. Take precautions to avoid incorrect wiring.

As for other pressure switches, the switches will be instantly damaged if loads are short circuited. Take special care to avoid reverse wiring between the brown power supply line and the black output line.

#### 3. Connect a DC(–) wire (blue) as close as possible to the DC power supply GND terminal.

Connecting the power supply away from the GND terminal can cause malfunctions due to noise from devices that are connected to the GND terminal.

#### 4. Do not attempt to insert or pull the pressure sensor or its connector when the power is on. A switch output malfunction may occur.

## Air Supply

### ⚠ Warning

#### 1. Use the switch within the specified fluid and ambient temperature range.

Ambient and fluid temperature operation is as follows:

Digital pressure switches: 0° to 50°C

Other pressure switches: 0° to 60°C

Take measures to prevent moisture from freezing in circuits when below 5°C, since this may cause damage to the O-ring and lead to a malfunction. The installation of an air dryer is recommended for eliminating condensate and moisture. Never use the switch in an environment where there are drastic temperature changes even when these temperatures are operated within the specified temperature range.

#### 2. Vacuum switch

An instant pressure pulse of up to 500kPa (0.5MPa) (at the time of vacuum release) will not affect the performance of the switch. However, a constant pressure of 200kPa (0.2MPa) or more should be avoided.

## Operating Environment

### ⚠ Warning

#### 1. Do not use in an area where surges are generated.

When there are units that generate a large amount of surge in the area around pressure switches (e.g., solenoid type lifters, high frequency induction furnaces, motors), this may cause deterioration or damage to the switches' internal circuitry. Avoid and protect against sources of surge generation and crossed lines.

#### 2. Operating environment

In general, the digital pressure switches featured here are not dust or splashproof. Avoid using in an environment where the likelihood of splashing or spraying of liquids (water, oil, etc.) exists. If used in such an environment, use a dustproof and splashproof type switch.

## Maintenance

### ⚠ Caution

#### 1. Cleaning of the switch body

Wipe off dirt with a soft cloth. If dirt does not come off easily, use a neutral detergent diluted with water to dampen a soft cloth. Wipe the switch only after squeezing the excess water out of the dampened cloth. Then finish off by wiping with a dry cloth afterwards.



# Series ZSE30/ISE30 Specific Product Precautions

Be sure to read before handling. Refer to pages 9 through 11 for safety instructions and pressure switch precautions.

## Handling

### ⚠ Warning

1. Do not drop, bump, or apply excessive impacts (980m/s<sup>2</sup>) while handling. Although the body of the sensor may not be damaged, the internal parts of the sensor could be damaged and lead to a malfunction.
2. The tensile strength of the cord is 35N. Applying a greater pulling force on it can cause a malfunction. When handling, hold the body of the sensor—do not dangle it from the cord.
3. Do not exceed the screw-in torque of 7 to 9 N·m when installing piping. Exceeding this value may cause malfunctioning of the sensor.
4. Do not use pressure sensors with corrosive and/or flammable gases or liquids.

## Connection

### ⚠ Warning

1. Incorrect wiring can damage the switch and cause a malfunction or erroneous switch output. Connections should be done while the power is turned off.
2. Do not attempt to insert or pull the pressure sensor or its connector when the power is on. A switch output malfunction may occur.
3. Wire separately from power lines and high voltage lines, avoiding wiring in the same conduit with these lines. Malfunctions may occur due to noise from these other lines.
4. If a commercial switching regulator is used, make sure that the F.G. terminal is grounded.

## Operating Environment

### ⚠ Warning

1. Our pressure switches are CE marked; however, they are not equipped with surge protection against lightning. Lightning surge countermeasures should be applied directly to system components as necessary.
2. Our pressure switches do not have an explosion proof rating. Never use in the presence of an explosive gas as this may cause a serious explosion.

## Mounting

### ⚠ Caution

#### 1. Mounting with panel mount adapter

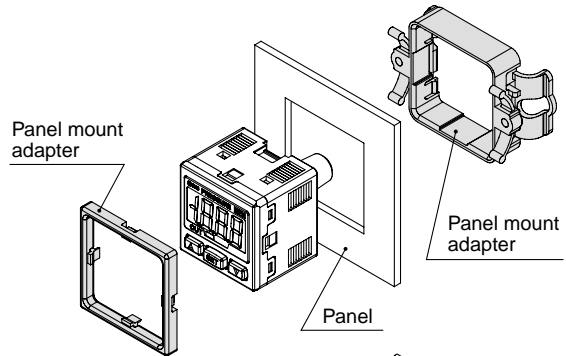

To release push the clips outward as shown on the picture, and pull back towards you.

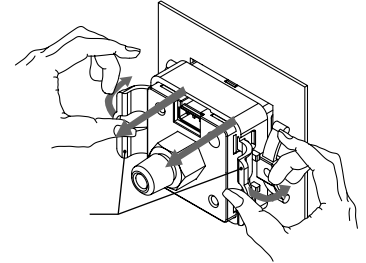

#### 2. Mounting with bracket

Mount a bracket to the body using two M3 x 5L mounting screws and install on piping with hexagon socket head cap screws. The switch can be installed horizontally depending on the installation location.

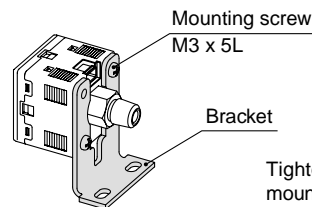

Tightening torque for bracket mounting screw should be 0.5 to 0.7N·m.

## Connection/Removal of Connector

- To connect the connector, insert it straight while pinching the lever, and then push the lever into the jack of the housing and lock it.
- To remove the connector, pull it straight out while applying pressure with your thumb to the lever and unhooking it from the jack.

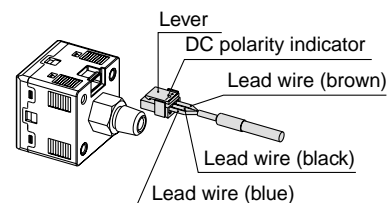

- Do not attempt to insert or pull the pressure sensor or its connector when the power is on. A switch output malfunction may occur.



## SMC'S GLOBAL MANUFACTURING, DISTRIBUTION AND SERVICE NETWORK

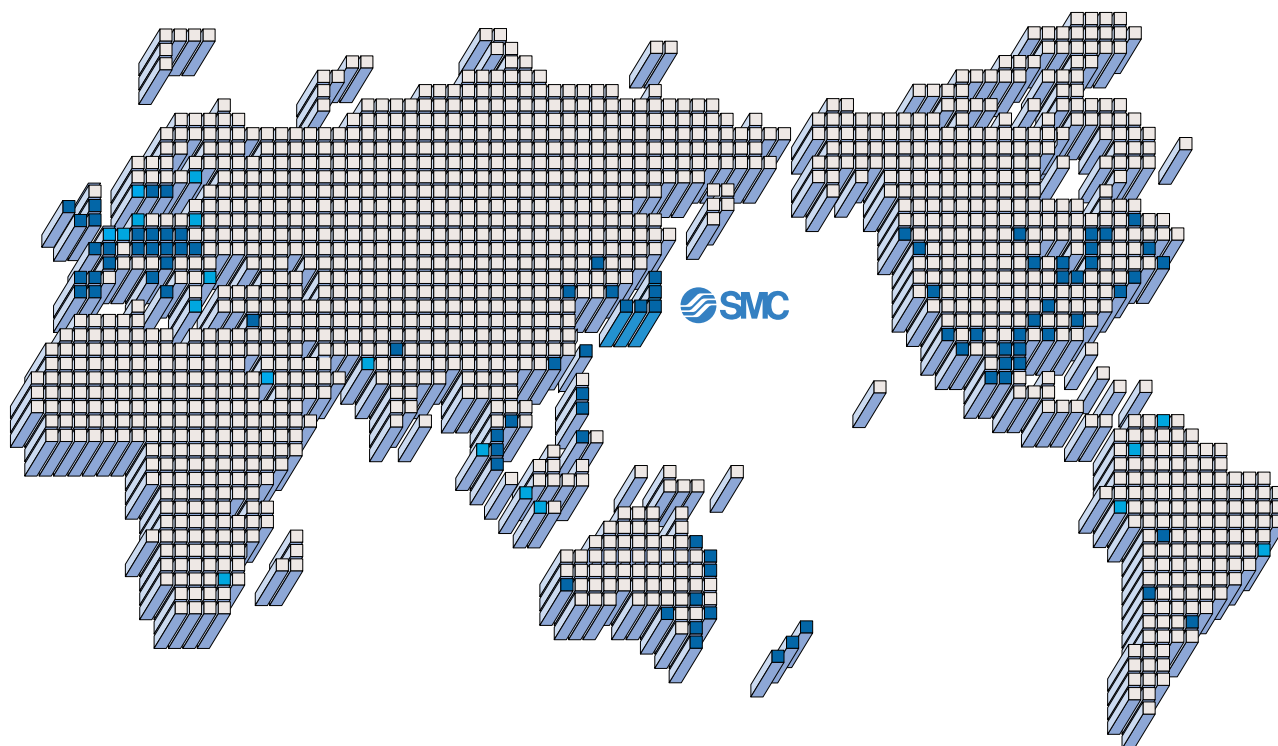

### EUROPE

#### AUSTRIA

SMC Pneumatik GmbH

#### CZECH

SMC Industrial Automation CZ s.r.o.

#### DENMARK

SMC Pneumatik A/S

#### FINLAND

SMC Pneumatics Finland Oy

#### FRANCE

SMC Pneumatique SA

#### GERMANY

SMC Pneumatik GmbH

#### HUNGARY

SMC Hungary Ipari Automatizálási Kft.

#### IRELAND

SMC Pneumatics (Ireland) Ltd.

#### ITALY

SMC Italia S.p.A.

#### NETHERLANDS

SMC Pneumatics BV.

#### NORWAY

SMC Pneumatics Norway A/S

#### POLAND

SMC Industrial Automation Polska Sp.z.o.o.

#### ROMANIA

SMC Romania s.r.l.

#### RUSSIA

SMC Pneumatik LLC.

#### SLOVAKIA

SMC Priemyselná automatizácia, s.r.o.

### EUROPE

#### SLOVENIA

SMC Industrijska Avtomatika d.o.o.

#### SPAIN/PORTUGAL

SMC España, S.A.

#### SWEDEN

SMC Pneumatics Sweden AB

#### SWITZERLAND

SMC Pneumatik AG.

#### UK

SMC Pneumatics (U.K.) Ltd.

### ASIA

#### CHINA

SMC (China) Co., Ltd.

#### HONG KONG

SMC Pneumatics (Hong Kong) Ltd.

#### INDIA

SMC Pneumatics (India) Pvt. Ltd.

#### MALAYSIA

SMC Malaysia (S.E.A.) Sdn. Bhd.

#### PHILIPPINES

SMC Pneumatics (Philippines), Inc.

#### SINGAPORE

SMC Pneumatics (S.E.A.) Pte. Ltd.

#### SOUTH KOREA

SMC Pneumatics Korea Co., Ltd.

#### TAIWAN

SMC Pneumatics (Taiwan) Co., Ltd.

#### THAILAND

SMC Thailand Ltd.

### NORTH AMERICA

#### CANADA

SMC Pneumatics (Canada) Ltd.

#### MEXICO

SMC Corporation (Mexico) S.A. de C.V.

#### USA

SMC Corporation of America

### SOUTH AMERICA

#### ARGENTINA

SMC Argentina S.A.

#### BOLIVIA

SMC Pneumatics Bolivia S.R.L.

#### BRAZIL

SMC Pneumaticos Do Brazil Ltda.

#### CHILE

SMC Pneumatics (Chile) S.A.

#### VENEZUELA

SMC Neumatica Venezuela S.A.

### OCEANIA

#### AUSTRALIA

SMC Pneumatics (Australia) Pty. Ltd.

#### NEW ZEALAND

SMC Pneumatics (N.Z.) Ltd.

## SMC CORPORATION

1-16-4 Shimbashi, Minato-ku, Tokyo 105-0004, JAPAN

Tel: 03-3502-2740 Fax: 03-3508-2480

URL <http://www.smcworld.com>

© 2001 SMC CORPORATION All Rights Reserved

1st printing September, 2001 D-SMC.L.A. P-80 (YG)

This catalog is printed on recycled paper with concern for the global environment.

All specifications in this catalog are subject to change without notice.

Printed in Japan.