

# Electromechanical Relays Selection Guide

Latching

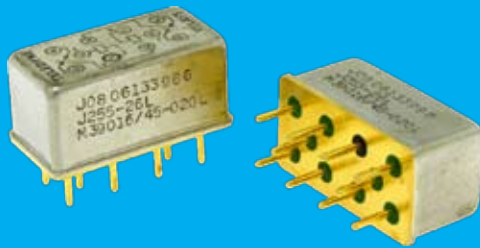

JAN



Non-Latching



RF



Commercial



Established Reliability

Surface-Mount



Environmental

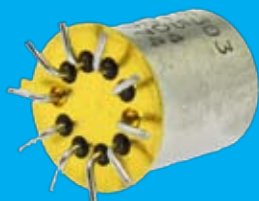

Attenuated

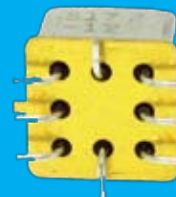

**TELEDYNE  
RELAYS**

A Teledyne Technologies Company



RoHS or Non-RoHS:  
Your Choice!



# Switching Solutions

Teledyne Relays has been the world's innovative leader in the manufacture of ultraminiature, hermetically sealed, electromechanical and solid-state switching products for more than 40 years. The company's comprehensive product line meets a wide range of requirements for defense and aerospace, industrial, commercial, medical and RF & wireless applications.

## Business Focus

- MIL QPL & COTS Solid-State Relays
- MIL QPL & COTS Electromechanical Relays
- HiRel (Space) Electromechanical Relays
- RF & Microwave Relays & Coaxial Switches
- Industrial Solid-State Relays
- Switching Matrices

## Markets

- Commercial & Military Aviation
- Defense & Aerospace
- Telecom/Communications (Wireless)
- Instrumentation & Test
- Industrial Power & Motion Control
- Medical Applications

## Product Assurance

Under an aggressive Total Quality Management (TQM) program, Teledyne Relays has embraced a "continuous improvement" culture. With recognized certifications such as AS/EN/JISQ 9100 - Revision B and ISO 9001:9002, DSCC MIL-STD-790 and Boeing D6-82479 Appendix A, Teledyne Relays has become a primary supplier of switching solutions with the highest quality and reliability to industry leaders around the world.

## Technical Service & Customer Support

Teledyne Relays provides easy access to technical service and customer support. Our websites make it easy to find technical information, buy products and even get e-mail responses within 24 hours. Switching solutions are only a mouse click away at [www.teledynereleys.com](http://www.teledynereleys.com) or at [teledyne-europe.com](http://teledyne-europe.com). Information about coax switches is available at [www.teledynecoax.com](http://www.teledynecoax.com).

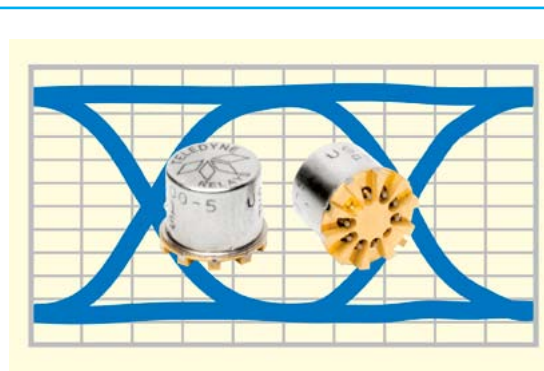

Teledyne Relays offer superior signal integrity up to 12 Gbps. See the RF relays section in our website.

# Table of Contents

RF RELAYS		
Series	Description	Page
<b>RF100/RF103</b>	High Repeatability, Broadband Centigrad® Relays, Non-Latching DPDT	4
<b>GRF172</b>	Surface-Mount Centigrad® RF Relays, Non-Latching DPDT	4
<b>RF300/RF303</b>	High Repeatability, Broadband TO-5 Relays, Non-Latching DPDT	5
<b>RF312</b>	High Repeatability, Broadband TO-5 Relays, Non-Latching DPDT	6
<b>RF311/RF331</b>	High Repeatability, Broadband TO-5 Relays, Non-Latching SPDT	7
<b>GRF342</b>	Surface-Mount TO-5 RF Relays, Magnetic-Latching DPDT	7
<b>RF180</b>	Broadband RF Relays, Magnetic-Latching DPDT	8
<b>RF341</b>	Broadband TO-5 RF Relays, Magnetic-Latching SPDT	8
<b>RF310/RF313</b>	High Repeatability TO-5 Relays, Normally Closed, Bypass	9
<b>RF320/RF323</b>	High Repeatability TO-5 Relays, Normally Open, Bypass	9
<b>A150</b>	Broadband Attenuator RF Relay	10
<b>A152</b>	Broadband Attenuator RF Relay	10
COMMERCIAL RELAYS		
<b>122C</b>	Centigrad® Relays (CMOS Compatible), Magnetic-Latching DPDT	11
<b>172</b>	Centigrad® Relays, Non-Latching DPDT	11
<b>712</b>	TO-5 Relays, Non-Latching DPDT	12
<b>722</b>	TO-5 Relays, Magnetic-Latching DPDT	12
<b>732</b>	TO-5 Relays, Non-Latching Sensitive DPDT	13
COMMERCIAL SURFACE-MOUNT RELAYS		
<b>S114</b>	Surface-Mount Centigrad® Relays, Non-Latching DPDT	14
<b>S134</b>	Surface-Mount Centigrad® Relays, Non-Latching Sensitive DPDT	14
<b>S172</b>	Surface-Mount Centigrad® Relays, Non-Latching DPDT	15
<b>S422</b>	Surface-Mount TO-5 Relays, Magnetic-Latching DPDT	15
ESTABLISHED RELIABILITY RELAYS		
<b>ER114</b>	Centigrad® Relays, Non-Latching DPDT	16
<b>ER116C</b>	Centigrad® Relays (CMOS Compatible), Non-Latching DPDT	16
<b>ER134</b>	Centigrad® Relays, Non-Latching Sensitive DPDT	17
<b>ER136C</b>	Centigrad® Relays (CMOS Compatible), Non-Latching Sensitive DPDT	17

See specific series for additional features and options

Continued on next page

# Table of Contents

ESTABLISHED RELIABILITY RELAYS (continued)		
Series	Description	Page
<b>ER411</b>	TO-5 Relays, Non-Latching SPDT	18
<b>ER431</b>	TO-5 Relays, Non-Latching Sensitive SPDT	18
<b>ER412</b>	TO-5 Relays, Non-Latching DPDT	19
<b>ER432</b>	TO-5 Relays, Non-Latching Sensitive DPDT	19
<b>255</b>	Half-Size Crystal Can, Magnetic-Latching DPDT	20
<b>ER421</b>	TO-5 Relays, Magnetic-Latching SPDT	20
<b>ER420</b>	TO-5 Relays, Magnetic-Latching DPDT	21
<b>ER422</b>	TO-5 Relays, Magnetic-Latching DPDT	21
MILITARY QUALIFIED (JAN) RELAYS		
<b>J114</b>	Centigrid® Relays, Non-Latching DPDT	22
<b>J116C</b>	Centigrid® Relays (CMOS Compatible), Non-Latching DPDT	22
<b>J134</b>	Centigrid® Relays, Non-Latching Sensitive DPDT	23
<b>J136C</b>	Centigrid® Relays (CMOS Compatible), Non-Latching Sensitive DPDT	23
<b>J411</b>	TO-5 Relays, Non-Latching SPDT	24
<b>J431</b>	TO-5 Relays, Non-Latching Sensitive SPDT	24
<b>J412</b>	TO-5 Relays, Non-Latching DPDT	25
<b>J432</b>	TO-5 Relays, Non-Latching Sensitive DPDT	25
<b>J255</b>	Half-Size Crystal Can, Magnetic-Latching DPDT	26
<b>J421</b>	TO-5 Relays, Magnetic-Latching SPDT	26
<b>J420</b>	TO-5 Relays, Magnetic-Latching DPDT	27
<b>J422</b>	TO-5 Relays, Magnetic-Latching DPDT	27
HIGH-PERFORMANCE RELAYS		
<b>412H/432H</b>	High-Temperature (200°C) TO-5 Relays, Non-Latching DPDT	28
<b>422H</b>	High-Temperature (200°C) TO-5 Relays, Magnetic-Latching DPDT	28
<b>412K</b>	High-Shock TO-5 Relays, Non-Latching DPDT	29
<b>422K</b>	High-Shock TO-5 Relays, Magnetic-Latching DPDT	29
<b>412V/432V</b>	High-Vibration TO-5 Relays, Non-Latching DPDT	30

See specific series for additional features and options









Continued on next page



# Table of Contents

APPENDIX		
	Description	Page
	Signal Integrity Eye Diagrams	31-38
	RoHS and Reach Certificate of Compliance	39
	Part Numbering System	40-41
	Spacer Pad Options	42
	Spreader Pad Options	43
	Ground Pin Options	44
	Established Reliability Program	45-46
	Teledyne Relays HI-REL Program	47
	Authorized Distributors	48
	Authorized North American Representatives	49

**Teledyne Relays offers a variety of options to customize and meet your specific design needs.**

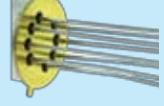
 <p><b>GRF Option</b> TO-5 Relays with straight butt pins for surface-mount applications * RF Relays Only</p>	 <p><b>SGRF Option</b> TO-5 Relays with Gull-Wing (J-Lead) pins for surface-mount applications * RF Relays Only</p>	 <p><b>GRF Option</b> Centigrad® Relays with straight butt pins for surface-mount applications * RF Relays Only</p>
 <p><b>SGRF Option</b> TO-5 Relays with Gull-Wing (J-Lead) pins for surface-mount applications * RF Relays Only</p>	 <p><b>SRF Option</b> Relays with Gull-Wing (J-Lead) pins for surface-mount applications * RF Relays Only</p>	 <p><b>/S Option</b> Relays with 0.187" trimmed leads See Appendix: Part Numbering System</p>
 <p><b>Spacer Pad Option</b> Relays with polyester film pad to space between PCB and Relay Header See Appendix: Spacer Pad Options</p>	 <p><b>Spreader Pad Option</b> Relays with Diallyl Phthalate pad to spread pins See Appendix: Spreader Pad Options</p>	 <p><b>/Q, /R Option</b> Relays with solder dipped leads. Pb/Sn (60/40) or RoHS solder available See Appendix: Part Numbering System</p>

See specific series for additional features and options

# RF RELAYS

## Series RF100/RF103 Electromechanical Relays





The RF100 and RF103 Centigrad® relays are designed to provide improved RF signal repeatability over the frequency range.

The GRF100 and GRF103 Centigrad® relays feature a unique ground shield that isolates and shields each lead to ensure excellent contact-to-contact and pole-to-pole isolation. This ground shield provides a ground interface that results in improved high-frequency performance as well as parametric repeatability.

The SGRF100 and SGRF103 Centigrad® relays extend performance advantages over similar RF devices that simply offer formed leads for surface mounting.

- Excellent Signal integrity up to 10Gbps
- Hermetically Sealed
- High Resistance to ESD
- Metal Enclosure for EMI shielding
- High Repeatability
- Broader bandwidth
- Through-hole or surface-mount configurations

Relay Type
DPDT Non-Latching
Coil Type
100 = Standard Coil 103 = Sensitive Coil
Mounting
RF = Thru-hole GRF = Surface-Mount (Stub) SGRF = Surface-Mount (J-Lead)
Temperature
Storage: -65°C to +125°C Operating: -55°C to +85°C

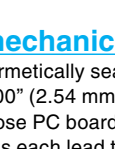
Part No.	Nominal Coil		Typical RF Performance				
	Voltage (Vdc)	Resistance (Ω)	Frequency (GHz)	VSWR (max)	Isolation (dB)		Insertion Loss (dB) (max)
					Pole to Pole (min)	Across Contacts (min)	
 <b>RF100</b>	5	50	DC-1	1.1 : 1	35	25	0.2
	12	390	1-2	1.5 : 1	30	20	0.5
 <b>RF103</b>	5	100	2-3	1.6 : 1	30	20	0.6
	12	800					
 <b>GRF100</b>	5	50	DC-1	1.1 : 1	45	30	0.2
	12	390	1-3	1.2 : 1	40	25	0.3
 <b>GRF103</b>	5	100	3-4	1.3 : 1	35	25	0.6
	12	800	4-6	2.2 : 1	30	25	1.2
 <b>SGRF100</b>	5	50	DC-1	1.2 : 1	35	30	0.2
	12	390	1-3	1.3 : 1	30	30	0.7
 <b>SGRF103</b>	5	100	3-4	1.4 : 1	25	25	0.8
	12	800	4-6	1.8 : 1	25	25	1.0

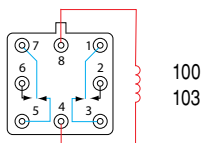

## Series GRF172 Electromechanical Relays

The GRF172 Centigrad® relay is a hermetically sealed, armature relay for 2.5GHz RF applications. Its low profile height .330" (8.38 mm) and .100" (2.54 mm) grid spaced terminals make it an ideal choice where extreme packaging density and/or close PC board spacing are required. The GRF172 features a unique ground shield that isolates and shields each lead to ensure excellent contact-to-contact and pole-to-pole isolation. This ground shield provides a ground interface that results in improved high-frequency performance as well as parametric repeatability. The GRF172 extends performance advantages over similar RF devices that simply offer formed leads for surface mounting.

The Series GRF172D has an internal discrete silicon diode for coil suppression.

- Excellent Signal integrity up to 10Gbps
- Hermetically Sealed
- High Resistance to ESD
- Metal Enclosure for EMI shielding
- High Repeatability
- Broader bandwidth
- Through-hole or surface-mount configurations

Relay Type
DPDT Non-Latching
Coil Type
172 = Standard Coil
Diode Option
D = Internal diode for coil transient suppression
Mounting
GRF = Surface-Mount (Stub)
Temperature
Storage: -65°C to +125°C Operating: -55°C to +85°C

Part No.	Nominal Coil		Typical RF Performance				
	Voltage (Vdc)	Resistance (Ω)	Frequency (GHz)	VSWR (max)	Isolation (dB)		Insertion Loss (dB) (max)
					Pole to Pole (min)	Across Contacts (min)	
 <b>GRF172</b>	5	50	DC-1	1.1 : 1	45	30	0.2
	12	390	1-2	1.2 : 1	40	25	0.3
	26	100	2-2.5	1.2 : 1	40	25	0.3

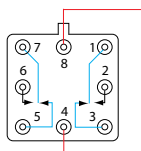

GRF172

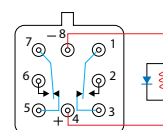

GRF172D

Schematics as viewed from terminals

# RF RELAYS

## Series RF300/RF303 Electromechanical Relays





The RF300 and RF303 TO-5 relays are designed to provide improved RF signal repeatability over the frequency range.

The GRF300 and GRF303 TO-5 relays feature a unique ground shield that isolates and shields each lead to ensure excellent contact-to-contact and pole-to-pole isolation. This ground shield provides a ground interface that results in improved high-frequency performance as well as parametric repeatability.

The SGRF300 and SGRF303 TO-5 relays extend performance advantages over similar RF devices that simply offer formed leads for surface mounting.

- Excellent Signal integrity up to 10Gbps+
- Hermetically Sealed
- High Resistance to ESD
- Metal Enclosure for EMI shielding
- High Repeatability
- Broader bandwidth
- Through-hole or surface-mount configurations

Relay Type
DPDT Non-Latching
Coil Type
300 = Standard Coil 303 = Sensitive Coil
Diode Option
D = Internal diode for coil transient suppression DD = Internal diode for coil transient suppression and polarity reversal protection
Mounting
RF = Thru-hole GRF = Surface-Mount (Stub) SGRF = Surface-Mount (J-Lead) SRF = Surface Mount (J-Lead)
Temperature
Storage: -65°C to +125°C Operating: -55°C to +85°C

Part No.	Nominal Coil		Typical RF Performance				
	Voltage (Vdc)	Resistance (Ω)	Frequency (GHz)	VSWR (max)	Isolation (dB)		Insertion Loss (dB) (max)
					Pole to Pole (min)	Across Contacts (min)	
 <b>RF300</b>	5	50	DC-1	1.1 : 1	30	25	0.2
<b>RF300D</b>	12	390	1-2	1.1 : 1	25	20	0.3
<b>RF303</b>	5	100	2-3	1.2 : 1	25	20	0.4
<b>RF303D</b>	12	850					
 <b>GRF300</b>	5	50	DC-1	1.1 : 1	40	30	0.2
<b>GRF300D</b>	12	390	1-3	1.1 : 1	40	30	0.2
<b>GRF303</b>	5	100	3-4	1.3 : 1	30	30	0.6
<b>GRF303D</b>	12	850	4-6	1.6 : 1	25	25	1.0
 <b>SGRF300</b>	5	50	DC-1	1.2 : 1	40	30	0.2
<b>SGRF300D</b>	12	390	1-3	1.2 : 1	40	30	0.4
<b>SGRF303</b>	5	100	3-4	1.2 : 1	20	25	0.8
<b>SGRF303D</b>	12	850	4-6	1.8 : 1	10	20	1.0
 <b>SRF300</b>	5	50	DC-1	1.1 : 1	25	25	0.5
<b>SRF300D</b>	12	390	1-3	1.5 : 1	25	25	0.5
<b>SRF303</b>	5	100	3-4	2.0 : 1	15	15	3.0
<b>SRF303D</b>	12	850	4-6	2.5 : 1	10	10	4.0

For RF300DD & RF303DD values please see Datasheet

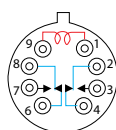

300  
303

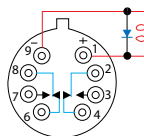

300D  
303D

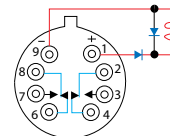

300DD  
303DD

Schematics as viewed from terminals

# RF RELAYS



## Series RF312 Electromechanical Relays

The RF312 is designed to improve upon the RF300/RF303 relay's high frequency performance. The RF312 offers monotonic insertion loss over to 8GHz. This improvement in RF insertion loss over the frequency range, makes these relays highly suitable for use in attenuator and other RF circuits.

The GRF312 is designed to improve upon the GRF300/GRF303 relay's high frequency performance. The GRF312 TO-5 relay features a unique ground shield that isolates and shields each lead to ensure excellent contact-to-contact and pole-to-pole isolation. This ground shield provides a ground interface that results in improved high-frequency performance as well as parametric repeatability.

- Excellent Signal integrity up to 12Gbps+
- Hermetically Sealed
- High Resistance to ESD
- Metal Enclosure for EMI shielding
- High Repeatability
- Broader bandwidth
- Through-hole or surface-mount configurations

Relay Type
DPDT Non-Latching
Coil Type
312 = Standard Coil
Mounting
RF = Thru-hole
GRF = Surface-Mount (Stub)
SGRF = Surface-Mount (J-Lead)
Temperature
Storage: -65°C to +125°C
Operating: -55°C to +85°C

Part No.	Nominal Coil		Typical RF Performance				
	Voltage (Vdc)	Resistance (Ω)	Frequency (GHz)	VSWR (max)	Isolation (dB)		Insertion Loss (dB) (max)
					Pole to Pole (min)	Across Contacts (min)	
 <b>RF312</b>	5	50	DC-2	1.2 : 1	30	20	0.2
			2-4	1.2 : 1	25	20	0.4
	12	390	4-6	1.3 : 1	25	20	0.6
			6-8	1.4 : 1	20	20	0.8
 <b>GRF312</b>	5	50	DC-2	1.4 : 1	40	30	0.3
			2-4	1.4 : 1	40	30	0.5
	12	390	4-6	1.5 : 1	35	30	1.0
			6-8	1.5 : 1	35	30	1.5
 <b>SGRF312</b>	5	50	DC-2	1.2 : 1	40	30	0.2
			2-4	1.2 : 1	35	30	0.5
	12	390	4-6	1.3 : 1	30	25	1.0
			6-8	1.5 : 1	30	25	1.5

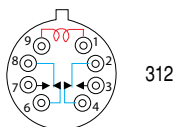

Schematics as viewed from terminals

# RF RELAYS

## Series RF311/RF331 Electromechanical Relays



The RF311/RF331 relays are designed to provide improved RF signal repeatability over the frequency range. These relays are highly suitable for use in attenuator and other RF circuits.

The GRF311 offers monotonic insertion loss to 8GHz. This improvement in RF insertion loss over the frequency range makes these relays highly suitable for use in attenuator and other RF circuits. The GRF311 features a unique ground shield that isolates and shields each lead to ensure excellent contact-to-contact isolation. This ground shield provides a ground interface that results in improved high-frequency performance as well as parametric repeatability.

- Excellent Signal integrity up to 10Gbps
- Hermetically Sealed
- High Resistance to ESD
- Metal Enclosure for EMI shielding
- High Repeatability
- Broader bandwidth
- Through-hole or surface-mount configurations

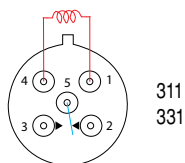
Relay Type
SPDT Non-Latching
Coil Type
311 = Standard Coil 331 = Sensitive Coil
Mounting
RF = Thru-hole GRF = Surface-Mount (Stub)
Temperature
Storage: -65°C to +125°C Operating: -55°C to +85°C



Part No.	Nominal Coil		Typical RF Performance			
	Voltage (Vdc)	Resistance (Ω)	Frequency (GHz)	VSWR (max)	Isolation Across Contacts (dB) (min)	Insertion Loss (dB) (max)
 <b>RF311</b>	5	63	DC-2	1.3 : 1	25	0.2
	12	500	2-4	1.6 : 1	20	0.4
	26	2000	4-6	1.6 : 1	20	0.6
	6-8	1.6 : 1	15	0.8		
 <b>GRF311</b>	5	63	DC-2	1.2 : 1	30	0.3
	12	500	2-4	1.5 : 1	25	0.5
	26	2000	4-6	1.5 : 1	25	0.7
	6-8	1.6 : 1	20	1.0		
 <b>RF331</b>	5	125	DC-2	1.3 : 1	25	0.2
	12	1025	2-4	1.6 : 1	20	0.4
	26	4000	4-6	1.6 : 1	20	0.6
	6-8	1.6 : 1	15	0.8		

## Series GRF342 Electromechanical Relays

The Series GRF342 relay is a hermetically sealed, RF relay designed from inception for surface mount applications. This magnetic-latching relay features extremely low internal circuit losses for exceptional time and frequency domain response characteristics through and beyond the UHF spectrum and into the S band. The GRF342 features a unique ground shield that isolates and shields each lead to ensure excellent contact-to-contact and pole-to-pole isolation. This ground shield provides an RF ground interface that results in improved high-frequency performance as well as parametric repeatability. The GRF342 extends performance advantages over similar RF devices that simply offer formed leads for surface mounting.

- Excellent Signal integrity up to 10Gbps
- Hermetically Sealed
- High Resistance to ESD
- Metal Enclosure for EMI shielding
- High Repeatability
- Broader bandwidth
- Through-hole or surface-mount configurations

Relay Type
DPDT Magnetic-Latching
Coil Type
342 = Standard Coil
Mounting
GRF = Surface-Mount (Stub)
Temperature
Storage: -65°C to +125°C Operating: -55°C to +85°C

Part No.	Nominal Coil		Typical RF Performance				
	Voltage (Vdc)	Resistance (Ω)	Frequency (GHz)	VSWR (max)	Isolation (dB)		Insertion Loss (dB) (max)
					Pole to Pole (min)	Across Contacts (min)	
 <b>GRF342</b>	5	50	DC-2	1.1 : 1	40	35	0.3
	12	390	2-4	1.2 : 1	30	30	0.4
	4-6	1.4 : 1	25	25	0.8		

Schematics as viewed from terminals

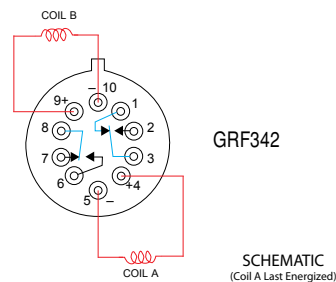

# RF RELAYS

## Series RF180 Electromechanical Relays

The Series RF180 relay is a hermetically sealed, magnetic-latching relay featuring extremely low intercontact capacitance for exceptional RF performance over the full UHF spectrum. Its low profile height and .100" (2.54 mm) grid spaced terminals make it ideal for applications where extreme packaging density and/or close PC board spacing are required.

The GRF180 features a unique ground shield that isolates and shields each lead to ensure excellent contact-to-contact and pole-to-pole isolation. This ground shield provides a ground interface that results in improved high-frequency performance as well as parametric repeatability.

- Excellent Signal integrity up to 10Gbps
- Hermetically Sealed
- High Resistance to ESD
- Metal Enclosure for EMI shielding
- High Repeatability
- Broader bandwidth
- Through-hole or surface-mount configurations

Relay Type
DPDT Magnetic-Latching
Coil Type
180 = Standard Coil
Mounting
RF = Thru-hole GRF = Surface-Mount (Stub)
Temperature
Storage: -65°C to +125°C Operating: -55°C to +85°C

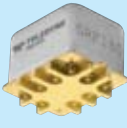
Part No.	Nominal Coil		Typical RF Performance				
	Voltage (Vdc)	Resistance (Ω)	Frequency (GHz)	VSWR (max)	Isolation (dB)		Insertion Loss (dB) (max)
					Pole to Pole (min)	Across Contacts (min)	
 <b>RF180</b>	5	61	DC-2	1.3 : 1	50	30	0.2
	12	500	2-4	1.3 : 1	45	30	0.3
	26	2000	4-6	2.0 : 1	30	25	1.5
 <b>GRF180</b>	5	61	DC-2	1.2 : 1	50	35	0.2
	12	500	2-4	1.3 : 1	35	30	0.4
	26	2000	4-6	2.0 : 1	25	30	1.5

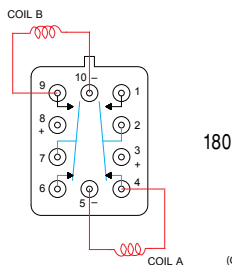



## Series RF341 Electromechanical Relays

The RF341 series relay is an ultraminiature, hermetically sealed, magnetic-latching relay featuring extremely low intercontact capacitance for exceptional RF performance well into the C band. Its low profile and small size make it ideal for applications where extreme packaging density and/or close PC board spacing are required. Due to its minimal mass, many relays may be used to configure replacements for bulkier switching solutions at substantial savings in weight. The RF341 design has been optimized by increasing the distance between the set/reset contacts. This design improvement makes these unique relays the perfect choice for use in RF attenuators, RF switching matrices and other RF applications requiring high isolation, low insertion loss and low VSWR.

The GRF341 features a unique ground shield that isolates and shields each lead to ensure excellent contact-to-contact isolation. This ground shield provides a ground interface that results in improved high-frequency performance as well as parametric repeatability.

- Excellent Signal integrity up to 10Gbps
- Hermetically Sealed
- High Resistance to ESD
- Metal Enclosure for EMI shielding
- High Repeatability
- Broader bandwidth
- Through-hole or surface-mount configurations

Relay Type
SPDT Magnetic-Latching
Coil Type
341 = Standard Coil
Mounting
RF = Thru-hole GRF = Surface-Mount (Stub)
Temperature
Storage: -65°C to +125°C Operating: -55°C to +85°C

Part No.	Nominal Coil		Typical RF Performance			
	Voltage (Vdc)	Resistance (Ω)	Frequency (GHz)	VSWR (max)	Isolation Across Contacts (min) (dB)	Insertion Loss (dB) (max)
 <b>RF341</b>	5	61	DC-2	1.2 : 1	30	0.5
	12	500	2-4	1.2 : 1	25	0.8
	26	2000	4-6	1.4 : 1	20	2.0
 <b>GRF341</b>	5	61	DC-2	1.2 : 1	35	0.3
	12	500	2-4	1.3 : 1	30	0.7
	26	2000	4-6	1.4 : 1	25	1.5

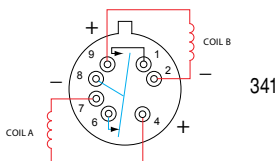

Schematics as viewed from terminals



# RF RELAYS

## Series RF310/RF313 Electromechanical Relays



The ultraminiature RF310 and RF313 relays are designed with an internal bypass (through path), when the coil is de-energized, to provide low insertion loss and VSWR through the bypass and simplicity of design for the user. Relays have improved RF insertion loss repeatability over the frequency range from DC to 3 GHz. Highly suitable for use in attenuator, linear amplifier and other RF circuits.

- N.C. bypass configuration
- Repeatability insertion loss
- Broad Bandwidth
- Metal Enclosure for EMI shielding
- Ground pin option to improve ground case RF grounding
- High isolation between control and signal path

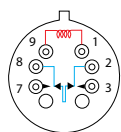
Relay Type
Normally Closed Bypass
Coil Type
310 = Standard Coil
313 = Sensitive Coil
Mounting
RF = Thru-hole
Temperature
Storage: -65°C to +125°C
Operating: -55°C to +85°C



RF310  
RF313

Part No.	Nominal Coil		Typical RF Performance						
	Voltage (Vdc)	Resistance (Ω)	Frequency (GHz)	VSWR		Isolation (dB)		Insertion Loss (dB)	
				N.O. (max)	Bypass (max)	N.O. (min)	Bypass (min)	N.O. (max)	Bypass (max)
 <b>RF310</b>	5	50	DC-1	1.2 : 1	1.3 : 1	35	25	0.2	0.3
	12	390	1-2	1.2 : 1	1.3 : 1	25	25	0.3	0.4
			2-3	1.4 : 1	1.3 : 1	25	20	0.4	0.5
 <b>RF313</b>	5	100	DC-1	1.2 : 1	1.3 : 1	35	25	0.2	0.3
	12	850	1-2	1.2 : 1	1.3 : 1	25	25	0.3	0.4
			2-3	1.5 : 1	1.3 : 1	25	20	0.5	0.4

## Series RF320/RF323 Electromechanical Relays



The ultraminiature RF320 and RF323 relays are designed with an internal bypass (through path), when the coil is energized, to provide low insertion loss and VSWR through the bypass and simplicity of design for the user. The RF320 and RF323 relays have improved RF insertion loss repeatability over the frequency range from DC to 3 GHz. Highly suitable for use in attenuator, linear amplifier and other RF circuits.

- N.O. bypass configuration
- Repeatability insertion loss
- Broad Bandwidth
- Metal Enclosure for EMI shielding
- Ground pin option to improve ground case RF grounding
- High isolation between control and signal path

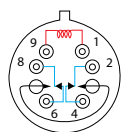
Relay Type
Normally Open Bypass
Coil Type
320 = Standard Coil
323 = Sensitive Coil
Mounting
RF = Thru-hole
Temperature
Storage: -65°C to +125°C
Operating: -55°C to +85°C



RF320  
RF323

Part No.	Nominal Coil		Typical RF Performance						
	Voltage (Vdc)	Resistance (Ω)	Frequency (GHz)	VSWR		Isolation (dB)		Insertion Loss (dB)	
				N.C. (max)	Bypass (max)	N.C. (min)	Bypass (min)	N.C. (max)	Bypass (max)
 <b>RF320</b>	5	50	DC-1	1.2 : 1	1.4 : 1	30	25	0.2	0.4
	12	390	1-2	1.2 : 1	1.4 : 1	30	20	0.3	0.4
			2-3	1.4 : 1	1.4 : 1	25	20	0.4	0.6
 <b>RF323</b>	5	100	DC-1	1.2 : 1	1.4 : 1	30	25	0.2	0.4
	12	850	1-2	1.2 : 1	1.4 : 1	30	20	0.3	0.4
			2-3	1.4 : 1	1.4 : 1	25	20	0.4	0.5

Schematics as viewed from terminals

# RF RELAYS

## Series A150 Electromechanical Relays



The Series A150 ultraminiature Attenuator Relays are designed for attenuating RF signals in 50-ohm systems over a frequency range from DC to 3 GHz. Their low profile and small grid spacing makes them ideal for use when packaging density is a prime consideration. The A150 relays eliminate the need for additional external resistors.

These single section, switchable attenuator relays have internal matched thin film attenuator pads in "L," "T" or "Pi" configurations, as applicable. Relays are available in fixed increments of 1, 2, 3, 4, 5, 6, 8, 10, 16 and 20 dB, which can be used singly or in combination to achieve the attenuation levels desired.

The GA150 features a unique ground shield that isolates and shields each lead to ensure excellent contact-to-contact isolation. This ground shield provides a ground interface that results in improved high-frequency performance as well as parametric repeatability.

- Excellent phase linearity
- Hermetically Sealed
- High Resistance to ESD
- Metal Enclosure for EMI shielding
- High Repeatability
- Broader bandwidth
- Through-hole or surface-mount configurations

Relay Type
RF Attenuator
Coil Type
A150 = Standard Coil
Mounting
A = Thru-hole GA = Surface-Mount (Stub)
Temperature
Storage: -65°C to +125°C Operating: -55°C to +85°C

Part No.	Nominal Coil		Frequency (GHz)	Typical RF Performance			
	Voltage (Vdc)	Resistance (Ω)		VSWR		Insertion Loss (dB)	
				Attenuated Path (Typ.)	Thru Path (Max.)	Typ.	Max.
 <b>A150</b>	5	50	DC-1	1.20 : 1	1.10 : 1	0.1	0.25
	12	390	1-2	1.30 : 1	1.20 : 1	0.2	0.35
	15	610	2-3	1.40 : 1	1.25 : 1	0.3	0.55
	26	1560					
 <b>GA150</b>	5	50	DC-1	1.20 : 1	1.20 : 1	0.1	0.25
	12	390	1-2	1.20 : 1	1.20 : 1	0.2	0.35
	15	610	2-3	1.20 : 1	1.30 : 1	0.3	0.45
	26	1560					

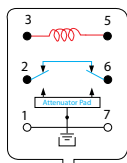

150

SCHEMATIC (Bottom View)

## Series A152 Electromechanical Relays



The Series A152 highly repeatable ultraminiature attenuator relays are designed for attenuating RF signals in 50-ohm systems over a frequency range from DC to 5 GHz. Their low profile and small grid spacing makes them ideal for use when packaging density is a prime consideration. The A152 relays eliminate the need for additional external resistors/attenuators.

These single section, switchable attenuator relays have an internal matched thin film attenuator pad in a "Pi" configuration. Relays are available in a fixed increment of 20 dB. (Other values available)

The GA152 features a unique ground shield that isolates and shields each lead to ensure excellent contact-to-contact isolation. This ground shield provides a ground interface that results in improved high-frequency performance as well as parametric repeatability.

- Hermetically Sealed
- High Resistance to ESD
- Metal Enclosure for EMI shielding
- High Repeatability
- Broader bandwidth
- Through-hole or surface-mount configurations

Relay Type
RF Attenuator
Coil Type
A152 = Standard Coil
Mounting
A = Thru-hole GA = Surface-Mount (Stub)
Temperature
Storage: -65°C to +125°C Operating: -55°C to +85°C

Part No.	Nominal Coil		Frequency (GHz)	Typical RF Performance			
	Voltage (Vdc)	Resistance (Ω)		VSWR		Insertion Loss (dB)	
				Attenuated Path (Typ.)	Thru Path (Max.)	Typ.	Max.
 <b>A152</b>	5	50	DC-1	1.20 : 1	1.10 : 1	0.1	0.25
	12	390	1-2	1.30 : 1	1.20 : 1	0.2	0.35
	15	610	2-3	1.40 : 1	1.25 : 1	0.3	0.55
	26	1560	3-5			See Datasheet	
 <b>GA152</b>	5	50	DC-1	1.20 : 1	1.20 : 1	0.1	0.25
	12	390	1-2	1.20 : 1	1.20 : 1	0.2	0.35
	15	610	2-3	1.20 : 1	1.30 : 1	0.3	0.45
	26	1560	3-5	1.40 : 1	1.70 : 1	0.4	0.55

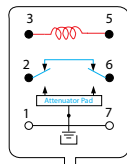

152

SCHEMATIC (Bottom View)

# COMMERCIAL RELAYS

## Series 122C Electromechanical Relays

The 122C Centigrad® magnetic-latching relay is an ultraminiature, hermetically sealed, armature relay capable of being directly driven by most IC logic families. Its low profile height and .100" (2.54 mm) grid spaced terminals, which precludes the need for spreader pads, make it ideal for applications where extreme packaging density and/or close PC board spacing are required.

The basic operating function and internal structure are similar to Teledyne's TO-5, 422 relay series. The 122C is capable of meeting Teledyne Relays' T2R® requirements.

The Series 122C relay has internal silicon diodes for coil suppression, Zener diodes to protect the MOSFET gate inputs, and N-channel enhancement-mode MOSFET chips, which enable direct relay interfacing with most microprocessor and IC logic families (CMOS, TTL and MOS).

The 122C magnetic-latching relay is ideally suited for applications where coil operating power must be minimized. The relays can be operated with a short-duration pulse. After the contacts have transferred, no external coil power is required.

The magnetic-latching feature of the Series 122C relay provides a "memory" capability, since the relays will not reset upon removal of coil power.

- All welded construction
- Unique uni-frame design providing high magnetic efficiency and mechanical rigidity
- High force/mass ratio for resistance to shock and vibration
- Precious metal alloy contact material with gold plating assures excellent high current and dry circuit switching capabilities

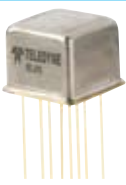
Relay Type		Part No.	Nominal Coil				Contact Load Rating	
DPDT Magnetic-Latching			Voltage (Vdc)	Coil Current (mA)		Operating Power (mW)		Latch and Reset Voltage (Vdc) (Max)
CMOS Feature		Min.		Max.				
Internal power MOSFET driver and diode coil suppression		 <b>122C</b>	5	82.2	114.9	505	3.5	Resistive: 1A/28Vdc
Vibration			6	41.6	57.0	296	4.5	Inductive: 200mA/28Vdc (320mH)
Shock			9	27.4	37.2	288	6.8	Lamp: 100mA/28Vdc
30 g's to 3000 Hz	100 g's 6 msec, half-sine		12	20.5	27.8	287	9.0	Low Level: 10 to 50 uA/10 to 50 mV
Acceleration			18	13.7	18.2	286	13.5	
Temperature			26	11.4	15.2	351	18.0	

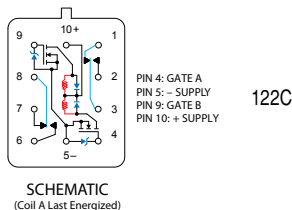

## Series 172 Electromechanical Relays

The 172 Centigrad® relay is an ultraminiature, hermetically sealed, armature relay for commercial applications. Its low profile height .280" (7.11 mm) and .100" (2.54 mm) grid spaced terminals, which preclude the need for spreader pads, make it an ideal choice where extreme packaging density and/or close PC board spacing are required.

The Series 172 relay has an internal discrete silicon diode for coil transient suppression.

By virtue of its inherently low intercontact capacitance and contact circuit losses, the 172 relay is an excellent subminiature RF switch for frequencies well into the UHF spectrum. Applications include telecommunications, test instruments, mobile communications, attenuators, and automatic test equipment.

- All welded construction
- Unique uni-frame design providing high magnetic efficiency and mechanical rigidity
- High force/mass ratio for resistance to shock and vibration
- Precious metal alloy contact material with gold plating assures excellent high current and dry circuit switching capabilities

Relay Type		Part No.	Nominal Coil				Contact Load Rating
DPDT Non-Latching			Voltage (Vdc)	Resistance (Ω)	P.U.V (Vdc) (max.)	Operating Power (mW)	
Diode Options		 <b>172</b> <b>172D</b>					3
D = Internal diode for coil transient suppression			5	64	3.8	405	Inductive: 200mA/28Vdc (320mH)
Vibration			12	400	9.0	360	Lamp: 100mA/28Vdc
Shock			26	1600	18.0	440	Low Level: 10 to 50 uA/10 to 50 mV

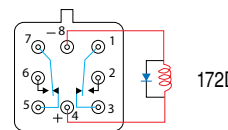
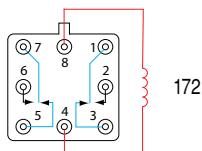

Schematics as viewed from terminals

P.U.V = Pick-Up Voltage

# COMMERCIAL RELAYS

## Series 712 Electromechanical Relays

The TO-5 relay, originally conceived and developed by Teledyne, has become one of the industry standards for low-level switching from dry circuit to 1 ampere. Designed for high-density PC board mounting, the Series 712 relays are some of the most versatile ultraminiature relays available because of their small size and low coil power dissipation.

The Series 712D relay has an internal discrete silicon diode for coil transient suppression. The hybrid Series 712TN relay has an internal silicon diode and transistor driver. The integrated packaging of the relay with its associated semiconductor devices greatly reduces PC board floor space requirements as well as component installation costs.

By virtue of its inherently low intercontact capacitance and contact circuit losses, the 712 has proven to be excellent ultraminiature RF switch for frequency ranges well into the UHF spectrum. A typical RF application for the TO-5 relay is in handheld radio transceivers, wherein the combined features of good RF performance, small size, low coil power dissipation and high reliability make it a preferred method of Transmit-Receive switching.

- All welded construction
- Unique uni-frame design providing high magnetic efficiency and mechanical rigidity
- High force/mass ratio for resistance to shock and vibration
- Precious metal alloy contact material with gold plating assures excellent high current and dry circuit switching capabilities

Relay Type		Part No.	Nominal Coil				Contact Load Rating
DPDT Non-Latching			Voltage (Vdc)	Resistance (Ω)	P.U.V (Vdc) (max.)	Base Current to Turn On (712 TN only)	
Diode Options		 <b>712</b> <b>712D</b> <b>712TN</b>	5	50	3.6	3.00	Resistive: 1A/28Vdc Inductive: 200mA/28Vdc (320mH) Lamp: 100mA/28Vdc Low Level: 10 to 50 uA/10 to 50 mV
D = Internal diode for coil transient suppression			6	98	4.2	2.04	
TN = Internal transistor driver and coil transient suppression diode			9	220	6.5	1.36	
Vibration			12	390	8.4	1.03	
Shock			18	880	13.0	0.68	
10 g's to 500 Hz		26	1560	17.0	0.50		
30 g's 6 msec, half-sine							
Temperature							
Storage: -65°C to +125°C							
Operating: -55°C to +85°C							

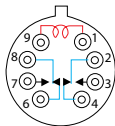

712

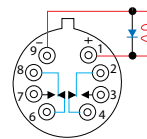

712D

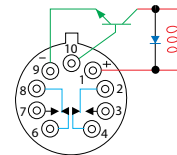

712TN

Schematics as viewed from terminals

## Series 722 Electromechanical Relays

The magnetic-latching TO-5 relay, originally conceived and developed by Teledyne, has become one of the industry standards for low-level switching from dry circuit to 1 ampere. Designed for high-density PC board mounting, the 722 relay has become one of the most versatile ultraminiature relays available because of its small size and low coil power dissipation.

The Series 722D relay has discrete silicon diodes for coil transient suppression.

The Series 722 magnetic-latching relays are ideally suited for applications where coil power dissipation must be minimized. The relays can be operated with a short duration pulse and after the contacts have transferred, no external coil power is required. The magnetic-latching feature of the Series 722 provides a "memory" capability, since the relays will not reset upon removal of coil power.

- All welded construction
- Unique uni-frame design providing high magnetic efficiency and mechanical rigidity
- High force/mass ratio for resistance to shock and vibration
- Precious metal alloy contact material with gold plating assures excellent high current and dry circuit switching capabilities

Relay Type		Part No.	Nominal Coil			Contact Load Rating
DPDT Magnetic-Latching			Voltage (Vdc)	Resistance (Ω)	Set & Reset Voltage (Vdc)	
Diode Options		 <b>722</b> <b>722D</b>	5	61	3.5	Resistive: 1A/28Vdc Inductive: 200mA/28Vdc (320mH) Lamp: 100mA/28Vdc Low Level: 10 to 50 uA/10 to 50 mV
D = Internal diode for coil transient suppression			6	120	4.5	
Vibration			9	280	6.8	
Shock			12	500	9.0	
10 g's to 500 Hz			18	1130	13.5	
30 g's 6 msec, half-sine		26	2000	18.0		
Temperature						
Storage: -65°C to +125°C						
Operating: -55°C to +85°C						

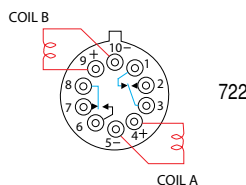

722

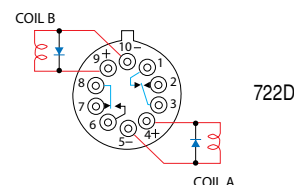

722D

SCHEMATIC  
(Coil A Last Energized)  
(Bottom View)

SCHEMATIC  
(Coil A Last Energized)  
(Bottom View)

COMMERCIAL

# COMMERCIAL RELAYS

## Series 732 Electromechanical Relays

The TO-5 relay, originally conceived and developed by Teledyne, has become one of the industry standards for low-level switching from dry circuit to 1 ampere. Designed for high-density PC board mounting, the Series 732 relay is one of the most versatile ultraminiature relays available because of their small size and low coil power dissipation. The sensitive 732 relay has a high resistance coil, thus requiring extremely low operating power (200 mW typical). The advantages of reduced heat dissipation and power supply demands are a plus. The Series 732D relay has an internal discrete silicon diode for coil transient suppression. The hybrid Series 732TN relay has an internal silicon diode and transistor driver. The integrated packaging of the relay with its associated semiconductor devices greatly reduces PC board floor space requirements as well as component installation costs.

By virtue of its inherently low intercontact capacitance and contact circuit losses, the 732 has proven to be excellent ultraminiature RF switch for frequency ranges well into the UHF spectrum. A typical RF application for the TO-5 relay is in handheld radio transceivers, wherein the combined features of good RF performance, small size, low coil power dissipation and high reliability make it a preferred method of Transmit-Receive switching.

- All welded construction
- Unique uni-frame design providing high magnetic efficiency and mechanical rigidity
- High force/mass ratio for resistance to shock and vibration
- Precious metal alloy contact material with gold plating assures excellent high current and dry circuit switching capabilities

Relay Type		Part No.	Nominal Coil				Contact Load Rating
DPDT Non-Latching Coil			Voltage (Vdc)	Resistance (Ω)	P.U.V (Vdc) (max.)	Base Current to Turn On (712 TN only)	
Diode Options			5	100	3.5	1.50	Resistive: 1A/28Vdc Inductive: 200mA/28Vdc (320mH) Lamp: 100mA/28Vdc Low Level: 10 to 50 uA/10 to 50 mV
D = Internal diode for coil transient suppression			6	200	4.5	1.00	
TN = Internal transistor driver and coil transient suppression diode			9	400	6.8	0.75	
Vibration	Shock		12	850	9.0	0.47	
10 g's to 500 Hz	30 g's 6 msec, half-sine		18	1600	13.5	0.38	
Temperature		26	3300	18.0	0.24		
Storage: -65°C to +125°C							
Operating: -55°C to +85°C							

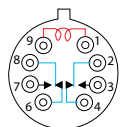

732

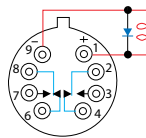

732D

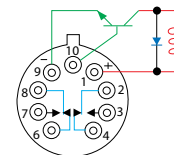

732TN

Schematics as viewed from terminals

# COMMERCIAL SURFACE-MOUNT RELAYS

## Series S114 & S134 Electromechanical Relays





The Series S114 Surface Mount Centigrad® Relay is an ultraminiature, hermetically sealed, armature relay. The low profile height .360" (9.14 mm) and .100" (2.54 mm) lead spacing make it ideal for applications where extreme packaging density and/or close PC board spacing are required. The specially formed leads are pre-tinned to make the relays ideal for most types of surface mount solder reflow processes.

The basic design and internal construction are identical to the Series 114 & 134 Centigrad® relays, and are capable of meeting Teledyne Relays' T2R® requirements.

The S114D and S114DD relays have internal discrete silicon diodes for coil suppression and polarity reversal protection.

The sensitive S134 surface mount Centigrad® Relay has a high resistance coil, thus requiring extremely low operating power (200 mW typical). The advantages of reduced heat dissipation and power supply demands are a plus.

- All welded construction
- Unique uni-frame design providing high magnetic efficiency and mechanical rigidity
- High force/mass ratio for resistance to shock and vibration
- Precious metal alloy contact material with gold plating assures excellent high current and dry circuit switching capabilities

Relay Type	Part No.	Nominal Coil					Contact Load Rating
		Voltage (Vdc)	Resistance (Ω)	P.U.V (Vdc) (max.)	D.O.V (Vdc)		
					min.	max.	
DPDT Non-Latching							
Coil Type							
S114 = Standard Coil	 S114 S114D	5	50	3.5	0.14	2.3	Resistive: 1A/28Vdc Inductive: 200mA/28Vdc (320mH) Lamp: 100mA/28Vdc Low Level: 10 to 50 uA/10 to 50 mV
S134 = Sensitive Coil		6	98	4.5	0.18	3.2	
Diode Options		9	220	6.8	0.35	4.9	
D = Internal diode for coil transient suppression		12	390	9.0	0.41	6.5	
DD = Internal diode for coil transient suppression and polarity reversal protection		18	880	13.5	0.59	10.0	
Vibration	 S114DD	5	39	4.0	0.6	2.8	Resistive: 1A/28Vdc Inductive: 200mA/28Vdc (320mH) Lamp: 100mA/28Vdc Low Level: 10 to 50 uA/10 to 50 mV
Shock		6	78	5.0	0.7	3.4	
30 g's to 3000 Hz		9	220	7.8	0.8	5.3	
75 g's 6 msec, half-sine		12	390	10.0	0.9	6.5	
Acceleration		18	880	14.5	1.1	10.0	
50 g's	26	1560	19.0	1.4	13.0		
Temperature	 S134 S134D	5	100	3.5	0.12	2.5	Resistive: 1A/28Vdc Inductive: 200mA/28Vdc (320mH) Lamp: 100mA/28Vdc Low Level: 10 to 50 uA/10 to 50 mV
Storage: -65°C to +125°C		6	200	4.5	0.18	3.2	
Operating: -55°C to +85°C		9	400	6.8	0.35	4.9	
		12	800	9.0	0.41	6.5	
		18	1600	13.5	0.59	10.0	
	26	3200	18.0	0.89	13.0		
	 S134DD	5	64	3.7	0.7	2.6	Resistive: 1A/28Vdc Inductive: 200mA/28Vdc (320mH) Lamp: 100mA/28Vdc Low Level: 10 to 50 uA/10 to 50 mV
		6	125	4.8	0.8	3.0	
		9	400	8.0	0.9	4.5	
		12	800	11.0	1.0	5.8	
		18	1600	14.5	1.1	9.0	
	26	3200	19.0	1.3	13.0		

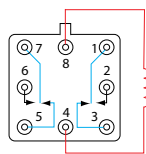

S114  
S134

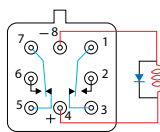

S114D  
S134D

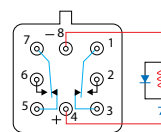

S114DD  
S134DD

Schematics as viewed from terminals



# COMMERCIAL SURFACE-MOUNT RELAYS

## Series S172 Electromechanical Relays

The S172 surface mount Centigrad® relay is an ultraminiature, hermetically sealed, armature relay for commercial applications. Its low profile height .470" (11.94 mm) and .100" (2.54 mm) grid spaced terminals make it an ideal choice where extreme packaging density and/or close PC board spacing are required. The specially formed surface-mount leads are pre-tinned to make the relays ideal for all types of surface-mount solder reflow processes.

The basic design and internal structure are similar to Teledyne's DPDT 114 Centigrad® relay. (see page 16) The S172D relay has an internal discrete silicon diode for coil transient suppression.

- All welded construction
- Unique uni-frame design providing high magnetic efficiency and mechanical rigidity
- High force/mass ratio for resistance to shock and vibration
- Precious metal alloy contact material with gold plating assures excellent high current and dry circuit switching capabilities

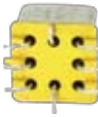
Relay Type		Part No.	Nominal Coil				Contact Load Rating
DPDT Non-Latching			Voltage (Vdc)	Resistance (Ω)	P.U.V (Vdc) (max.)	Operating Power (mW)	
<b>Diode Options</b>			5	64	3.8	405	Resistive: 1A/28Vdc Inductive: 200mA/28Vdc (320mH) Lamp: 100mA/28Vdc Low Level: 10 to 50 uA/10 to 50 mV
D = Internal diode for coil transient suppression			12	400	9.0	360	
<b>Vibration</b>			26	1600	18.0	440	
<b>Shock</b>							
10 g's to 500 Hz							
30 g's 6 msec, half-sine							
<b>Temperature</b>							
Storage: -65°C to +125°C							
Operating: -55°C to +85°C							

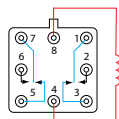

S172

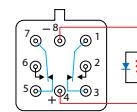

S172D

## Series S422 Electromechanical Relays

The magnetic-latching TO-5 relay, originally conceived and developed by Teledyne, has become one of the industry standards for low-level switching from dry circuit to 1 ampere. Designed for high-density PC board surface mounting, its small size and low coil power dissipation make the S422 relay one of the most versatile ultraminiature relays available.

The Series S422D and S422DD utilize discrete diodes for coil suppression and polarity reversal protection. The Series S422 magnetic-latching relays are ideally suited for applications where power dissipation must be minimized. The relays can be operated with a short duration pulse. After the contacts have transferred, no external holding power is required.

The magnetic-latching feature of the Series S422 relays provide a "memory" capability, since the relays will not reset upon removal of coil power.

- All welded construction
- Unique uni-frame design providing high magnetic efficiency and mechanical rigidity
- High force/mass ratio for resistance to shock and vibration
- Precious metal alloy contact material with gold plating assures excellent high current and dry circuit switching capabilities

Relay Type		Part No.	Nominal Coil			Contact Load Rating
DPDT Magnetic-Latching			Voltage (Vdc)	Resistance (Ω)	Set & Reset Voltage (Vdc)	
<b>Diode Options</b>			5	61	3.5	Resistive: 1A/28Vdc Inductive: 200mA/28Vdc (320mH) Lamp: 100mA/28Vdc Low Level: 10 to 50 uA/10 to 50 mV
D = Internal diode for coil transient suppression			6	120	4.5	
DD = Internal diode for coil transient suppression and polarity reversal protection			9	280	6.8	
<b>Vibration</b>			12	500	9.0	
<b>Shock</b>			18	1130	13.5	
10 g's to 500 Hz		26	2000	18.0		
30 g's 6 msec, half-sine						
<b>Temperature</b>						
Storage: -65°C to +125°C						
Operating: -55°C to +85°C						

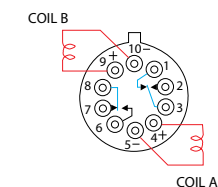

S422

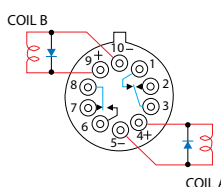

S422D

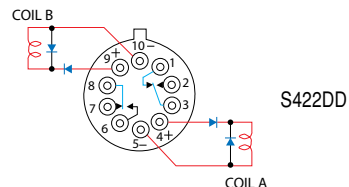

S422DD

Schematics as viewed from terminals

SCHEMATIC  
(Coil A Last Energized)

SCHEMATIC  
(Coil A Last Energized)

SCHEMATIC  
(Coil A Last Energized)

# ESTABLISHED RELIABILITY T<sup>2</sup>R RELAYS



## Series ER114 Electromechanical Relays

The Series ER114 Centigrad® relay is an ultraminiature, hermetically sealed, armature relay. Its low profile height .275" (7 mm) and .100" (2.54 mm) grid spaced terminals, which precludes the need for spreader pads, make it ideal for applications where extreme packaging density and/or close PC board spacing are required. The basic design and internal construction are similar to the standard Teledyne DPDT TO-5 relay (e.g., Series ER412).

The Series ER114D and ER114DD relays have internal discrete silicon diodes for coil suppression and polarity reversal protection.

By virtue of its inherently low intercontact capacitance and contact circuit losses, the ER114 relay has proven to be an excellent ultraminiature RF switch for frequency ranges well into the UHF spectrum. A typical RF application for the ER114 relay is in handheld radio transceivers, wherein the combined features of good RF performance, small size, low coil power dissipation and high reliability make it a preferred method of Transmit-Receive switching.

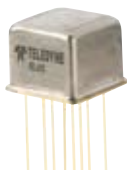
- All welded construction
- Unique uni-frame design providing high magnetic efficiency and mechanical rigidity
- High force/mass ratio for resistance to shock and vibration
- Precious metal alloy contact material with gold plating assures excellent high current and dry circuit switching capabilities

Relay Type		Part No.	Nominal Coil				Contact Load Rating	
DPDT Non-Latching			Voltage (Vdc)	Resistance (Ω)	P.U.V (Vdc) (max.)	D.O.V (Vdc)		
Diode Options						min.		max.
D = Internal diode for coil transient suppression		 <b>ER114</b>	5	50	3.5	0.14	2.3	Resistive: 1A/28Vdc Inductive: 200mA/28Vdc (320mH) Lamp: 100mA/28Vdc Low Level: 10 to 50 uA/10 to 50 mV
DD = Internal diode for coil transient suppression and polarity reversal protection			6	98	4.5	0.18	3.2	
Vibration			9	220	6.8	0.35	4.9	
Shock			12	390	9.0	0.41	6.5	
30 g's to 3000 Hz			18	880	13.5	0.59	10.0	
Acceleration		 <b>ER114DD</b>	5	39	4.0	0.6	2.8	Resistive: 1A/28Vdc Inductive: 200mA/28Vdc (320mH) Lamp: 100mA/28Vdc Low Level: 10 to 50 uA/10 to 50 mV
Temperature			6	78	5.0	0.7	3.4	
50 g's			9	220	7.8	0.8	5.3	
Operating & Storage: -65°C to +125°C			12	390	10.0	0.9	6.5	
			18	880	14.5	1.1	10.0	
		26	1560	19.0	1.4	13.0		

## Series ER116C Electromechanical Relays

The ER116C Centigrad® relay is an ultraminiature, hermetically sealed, armature relay capable of being directly driven by most IC logic families. Its low profile height and .100" (2.54 mm) grid spaced terminals, which preclude the need for spreader pads, make it ideal for applications where extreme packaging density and/or close PC board spacing are required.

The Series ER116C utilizes an internal silicon diode for coil suppression, a Zener diode to protect the MOSFET gate input, and an N-channel enhancement mode MOSFET chip, which enables direct relay interfacing with most Microprocessor and IC logic families (CMOS, TTL and MOS).

- All welded construction
- Unique uni-frame design providing high magnetic efficiency and mechanical rigidity
- High force/mass ratio for resistance to shock and vibration

Relay Type		Part No.	Nominal Coil				Contact Load Rating	
DPDT Non-Latching			Voltage (Vdc)	Coil Current (mA)		Operating Power (mW)		P.U.V (Vdc) (max.)
CMOS Feature				Min.	Max.			
Internal power MOSFET driver, Zener diode gate protection, and diode coil suppression		 <b>ER116C</b>	5	96.5	132.3	641	4.0	Resistive: 1A/28Vdc Inductive: 200mA/28Vdc (320mH) Lamp: 100mA/28Vdc Low Level: 10 to 50 uA/10 to 50 mV
Vibration			6	60.3	83.9	462	4.9	
Shock			9	33.1	47.1	368	7.3	
30 g's to 3000 Hz			12	24.9	36.1	369	9.8	
Acceleration			18	16.1	24.1	368	14.6	
Temperature			26	12.9	19.9	450	19.5	

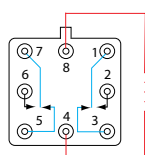

ER114

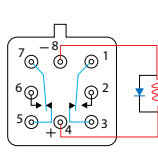

ER114D

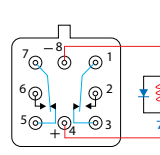

ER114DD

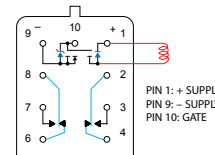

ER116C

P.U.V = Pick-Up Voltage

Schematics as viewed from terminals

ESTABLISHED RELIABILITY

# ESTABLISHED RELIABILITY T<sup>2</sup>R RELAYS



## Series ER134 Electromechanical Relays

The ER134 sensitive Centigrad® relay retains the same features as the ER114 standard Centigrad® relay with only a minimal increase in profile height .375" (9.53 mm). Its .100" (2.54 mm) grid spaced terminals, which preclude the need for spreader pads, and its low profile make the ER134 relay ideal for applications where high packaging density is important.

The Series ER134D and ER134DD have internal discrete silicon diodes for coil suppression and polarity reversal protection.

The sensitive ER134 Centigrad® relay has a high resistance coil, thus requiring extremely low operating power (200 mw typical). The advantages of reduced heat dissipation and power supply demands are a plus.

- All welded construction
- Unique uni-frame design providing high magnetic efficiency and mechanical rigidity
- High force/mass ratio for resistance to shock and vibration
- Precious metal alloy contact material with gold plating assures excellent high current and dry circuit switching capabilities

Relay Type		Part No.	Nominal Coil				Contact Load Rating	
Diode Options			Voltage (Vdc)	Resistance (Ω)	P.U.V (Vdc) (max.)	D.O.V (Vdc)		
						min.	max.	
DPDT Non-Latching		 <b>ER134</b> <b>ER134D</b>	5	100	3.5	0.12	2.5	Resistive: 1A/28Vdc Inductive: 200mA/28Vdc (320mH) Lamp: 100mA/28Vdc Low Level: 10 to 50 uA/10 to 50 mV
D = Internal diode for coil transient suppression			6	200	4.5	0.18	3.2	
DD = Internal diode for coil transient suppression and polarity reversal protection			9	400	6.8	0.35	4.9	
			12	800	9.0	0.41	6.5	
			18	1600	13.5	0.59	10.0	
Vibration		 <b>ER134DD</b>	5	64	3.7	0.7	2.6	Resistive: 1A/28Vdc Inductive: 200mA/28Vdc (320mH) Lamp: 100mA/28Vdc Low Level: 10 to 50 uA/10 to 50 mV
Shock			6	125	4.8	0.8	3.0	
30 g's to 3000 Hz			9	400	8.0	0.9	4.5	
75 g's 6 msec, half-sine			12	800	11.0	1.0	5.8	
Acceleration			18	1600	14.5	1.1	9.0	
Temperature		26	3200	19.0	1.3	13.0		
50 g's				Operating & Storage: -65°C to +125°C				

## Series ER136C Electromechanical Relays

The sensitive ER136C Centigrad® relay is an ultraminiature, hermetically sealed, armature relay capable of being directly driven by most IC logic families. Its low profile height and .100" (2.54 mm) grid spaced terminals, which precludes the need for spreader pads, make it ideal for applications where extreme packaging density and/or close PC board spacing are required.

The sensitive ER136C Centigrad® relay has a high resistance coil, thus requiring extremely low operating power (200 mW, typical). The advantages of reduced heat dissipation and power supply demands are a plus.

The sensitive Series ER136C utilizes an internal silicon diode for coil suppression, a Zener diode to protect the MOSFET gate input, and an N-channel enhancement-mode MOSFET chip that enables direct relay interfacing with most microprocessor and IC logic families (CMOS, TTL and MOS).

- All welded construction
- Unique uni-frame design providing high magnetic efficiency and mechanical rigidity
- High force/mass ratio for resistance to shock and vibration

Relay Type		Part No.	Nominal Coil				Contact Load Rating	
CMOS Feature			Voltage (Vdc)	Coil Current (mA)		Operating Power (mW)		P.U.V (Vdc) (max.)
		Min. Max.						
DPDT Non-Latching		 <b>ER136C</b>	5	43.0	56.0	250	4.0	Resistive: 1A/28Vdc Inductive: 200mA/28Vdc (320mH) Lamp: 100mA/28Vdc Low Level: 10 to 50 uA/10 to 50 mV
Internal power MOSFET driver, Zener diode gate protection, and diode coil suppression			6	27.0	33.0	180	4.9	
Vibration			9	17.8	26.4	203	7.3	
Shock			12	11.3	17.7	180	9.8	
30 g's to 3000 Hz			18	8.4	13.8	203	14.6	
75 g's 6 msec, half-sine		26	5.8	10.2	219	19.5		
Acceleration				Operating & Storage: -65°C to +125°C				
Temperature								
50 g's								

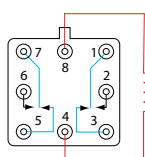

ER134

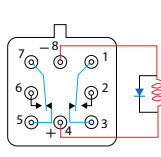

ER134D

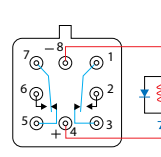

ER134DD

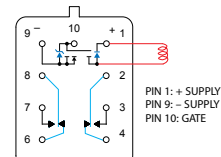

ER136C

Schematics as viewed from terminals

P.U.V = Pick-Up Voltage  
D.O.V = Drop-Out Voltage

# ESTABLISHED RELIABILITY T<sup>2</sup>R RELAYS

## Series ER411 & ER431 Electromechanical Relays







The TO-5 relay, originally conceived and developed by Teledyne, has become one of the industry standards for low-level switching from dry circuit to 1 ampere. Designed specifically for high-density PC board mounting, its small size and low coil power dissipation make the ER411 relay one of the most versatile ultraminiature relays available.

The Series ER411D and ER411DD relays have internal discrete silicon diodes for coil suppression and polarity reversal protection. The hybrid ER411T relay features an internal silicon suppression diode and transistor driver. This hybrid package reduces required PC board floor space by reducing the number of external components needed to drive the relay.

The sensitive ER431 relay has a high resistance coil, thus requiring extremely low operating power (150 mw typical). The advantages of reduced heat dissipation and power supply demands are a plus.

The Series ER431D and ER431DD relays have internal discrete silicon diodes for coil suppression and polarity reversal protection. The hybrid ER431T relay features an internal silicon suppression diode and transistor driver. This hybrid package reduces required PC board floor space by minimizing the number of external components needed to drive the relay.

- All welded construction
- Unique uni-frame design providing high magnetic efficiency and mechanical rigidity
- High force/mass ratio for resistance to shock and vibration
- Precious metal alloy contact material with gold plating assures excellent high current and dry circuit switching capabilities

Relay Type		Part No.	Nominal Coil				Contact Load Rating	
SPDT Non-Latching			Voltage (Vdc)	Resistance (Ω)	P.U.V (Vdc) (max.)	D.O.V (Vdc)		
Coil Type						min.		max.
ER411 = Standard Coil		 <b>ER411</b>	5	63	3.7	0.15	2.4	Resistive: 1A/28Vdc Inductive: 200mA/28Vdc (320mH) Lamp: 100mA/28Vdc Low Level: 10 to 50 uA/10 to 50 mV
ER431 = Sensitive Coil			6	125	4.5	0.18	2.8	
Diode Options			9	280	6.8	0.35	4.2	
D = Internal diode for coil transient suppression			12	500	9.0	0.40	5.6	
DD = Internal diode for coil transient suppression and polarity reversal protection			18	1130	13.5	0.58	8.4	
T = Internal transistor drive and coil transient suppression diode		26	2000	18.0	0.89	10.4		
Vibration	Shock	 <b>ER411DD</b>	5	50	4.5	0.15	2.4	Resistive: 1A/28Vdc Inductive: 200mA/28Vdc (320mH) Lamp: 100mA/28Vdc Low Level: 10 to 50 uA/10 to 50 mV
30 g's to 3000 Hz	75 g's 6 msec. half-sine		6	98	5.5	0.18	2.8	
Acceleration	Temperature		9	280	7.8	0.35	4.2	
50 g's	Operating & Storage: -65°C to +125°C		12	500	10.0	0.40	5.6	
			18	1130	14.5	0.58	8.4	
		26	2000	19.0	0.89	10.4		
		 <b>ER411T</b>	5	63	3.9	0.15	2.4	Resistive: 1A/28Vdc Inductive: 200mA/28Vdc (320mH) Lamp: 100mA/28Vdc Low Level: 10 to 50 uA/10 to 50 mV
			6	125	5.2	0.18	2.8	
			9	280	7.8	0.35	4.2	
			12	500	10.0	0.40	5.6	
			18	1130	14.5	0.58	8.4	
		26	2000	19.0	0.89	10.4		
		 <b>ER431</b>	5	125	3.7	0.15	2.0	Resistive: 1A/28Vdc Inductive: 200mA/28Vdc (320mH) Lamp: 100mA/28Vdc Low Level: 10 to 50 uA/10 to 50 mV
			6	255	4.5	0.18	2.8	
			9	630	6.8	0.35	4.2	
			12	1025	9.0	0.41	5.6	
			18	2300	13.5	0.58	8.4	
		26	4000	18.0	0.89	10.4		
		 <b>ER431DD</b>	5	100	4.5	0.15	2.4	Resistive: 1A/28Vdc Inductive: 200mA/28Vdc (320mH) Lamp: 100mA/28Vdc Low Level: 10 to 50 uA/10 to 50 mV
			6	200	5.5	0.18	2.8	
			9	630	7.8	0.35	4.2	
			12	1025	10.0	0.40	5.6	
			18	2300	14.5	0.58	8.4	
		26	4000	19.0	0.89	10.4		
		 <b>ER431T</b>	5	125	3.6	0.15	2.0	Resistive: 1A/28Vdc Inductive: 200mA/28Vdc (320mH) Lamp: 100mA/28Vdc Low Level: 10 to 50 uA/10 to 50 mV
			6	255	4.8	0.18	2.8	
			9	630	7.8	0.35	4.2	
			12	1025	10.0	0.41	5.6	
			18	2300	14.5	0.58	8.4	
		26	4000	19.0	0.89	10.4		

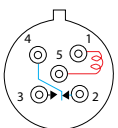

ER411  
ER431

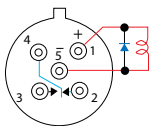

ER411D  
ER431D

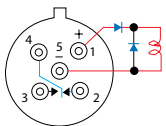

ER411DD  
ER431DD

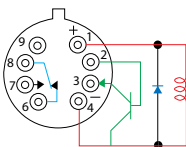

ER411T  
ER431T

Schematics as viewed from terminals

P.U.V = Pick-Up Voltage  
D.O.V = Drop-Out Voltage

ESTABLISHED RELIABILITY

# ESTABLISHED RELIABILITY T<sup>2</sup>R RELAYS

## Series ER412 & ER432 Electromechanical Relays







The TO-5 relay, originally conceived and developed by Teledyne, has become one of the industry standards for low-level switching from dry circuit to 1 ampere. Designed specifically for high-density PC board mounting, its small size and low coil power dissipation make the ER412 relay one of the most versatile ultraminiature relays available.

The Series ER412D and ER412DD relays have internal discrete silicon diodes for coil suppression and polarity reversal protection. The hybrid ER412T relay features an internal silicon suppression diode and transistor driver. This hybrid package reduces required PC board floor space by reducing the number of external components needed to drive the relay.

The sensitive ER432 relay has a high resistance coil, thus requiring extremely low operating power (200 mw typical). The advantages of reduced heat dissipation and power supply demands are a plus.

The Series ER432D and ER432DD relays have internal discrete silicon diodes for coil suppression and polarity reversal protection. The hybrid ER432T relay features an internal silicon suppression diode and transistor driver. This hybrid package reduces required PC board floor space by minimizing the number of external components needed to drive the relay.

- All welded construction
- Unique uni-frame design providing high magnetic efficiency and mechanical rigidity
- High force/mass ratio for resistance to shock and vibration
- Precious metal alloy contact material with gold plating assures excellent high current and dry circuit switching capabilities

Relay Type		Part No.	Nominal Coil				Contact Load Rating	
Coil Type			Voltage (Vdc)	Resistance (Ω)	P.U.V (Vdc) (max.)	D.O.V (Vdc)		
Diode Options						min.	max.	
DPDT Non-Latching								
ER412 = Standard Coil		 <b>ER412</b>	5	50	3.5	0.14	2.3	Resistive: 1A/28Vdc
ER432 = Sensitive Coil			6	98	4.5	0.18	3.2	Inductive: 200mA/28Vdc (320mH)
			9	220	6.8	0.35	4.9	Lamp: 100mA/28Vdc
			12	390	9.0	0.41	6.5	Low Level: 10 to 50 uA/10 to 50 uA
			18	880	13.5	0.59	10.0	
		26	1560	18.0	0.89	13.0		
		 <b>ER412DD</b>	5	39	3.9	0.6	2.8	Resistive: 1A/28Vdc
			6	78	5.2	0.7	3.4	Inductive: 200mA/28Vdc (320mH)
			9	220	7.8	0.8	5.3	Lamp: 100mA/28Vdc
			12	390	10.0	0.9	6.5	Low Level: 10 to 50 uA/10 to 50 uA
			18	880	14.5	1.1	10.0	
		26	1560	19.0	1.4	13.0		
		 <b>ER412T</b>	5	50	3.5	0.14	2.3	Resistive: 1A/28Vdc
			6	98	4.5	0.18	3.2	Inductive: 200mA/28Vdc (320mH)
			9	220	6.8	0.35	4.9	Lamp: 100mA/28Vdc
			12	390	9.0	0.41	6.5	Low Level: 10 to 50 uA/10 to 50 mV
			18	880	13.5	0.59	10.0	
		26	1560	18.0	0.89	13.0		
		 <b>ER432</b>	5	100	3.5	0.14	2.5	Resistive: 1A/28Vdc
			6	200	4.5	0.18	3.2	Inductive: 200mA/28Vdc (320mH)
			9	400	6.8	0.35	4.9	Lamp: 100mA/28Vdc
			12	850	9.0	0.41	6.5	Low Level: 10 to 50 uA/10 to 50 mV
			18	1600	13.5	0.59	10.0	
		26	3300	18.0	0.89	13.0		
		 <b>ER432DD</b>	5	64	3.7	0.7	2.6	Resistive: 1A/28Vdc
			6	125	4.8	0.8	3.0	Inductive: 200mA/28Vdc (320mH)
			9	400	8.0	0.9	4.5	Lamp: 100mA/28Vdc
			12	850	11.0	1.0	5.8	Low Level: 10 to 50 uA/10 to 50 mV
			18	1600	14.5	1.1	9.0	
		26	3300	19.0	1.3	13.0		
		 <b>ER432T</b>	5	100	3.6	0.14	2.5	Resistive: 1A/28Vdc
			6	200	4.8	0.18	3.2	Inductive: 200mA/28Vdc (320mH)
			9	400	7.8	0.35	4.9	Lamp: 100mA/28Vdc
			12	850	11.0	0.41	6.5	Low Level: 10 to 50 uA/10 to 50 mV
			18	1600	14.5	0.59	10.0	
		26	3300	19.0	0.89	13.0		

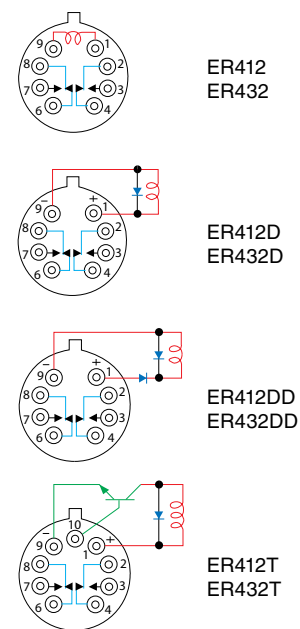

Schematics as viewed from terminals

P.U.V = Pick-Up Voltage  
D.O.V = Drop-Out Voltage

ESTABLISHED RELIABILITY



# ESTABLISHED RELIABILITY T<sup>2</sup>R RELAYS

## Series 255, 256, 257, 258 Electromechanical Relays

The Series 255 is an industry-standard, half-size, latching crystal can relay. It has a wide range of switching capabilities ranging from low level to 2 amps. The Series J255/255 latching relay configuration is double-pole double-throw (DPDT), so the relay offers excellent switching density and versatility.

Half-Size Crystal Can Features:

- Low level to 2 amps
- Wide range of switching capabilities
- Smallest relay package capable of switching 2 amps
- Modernized assembly process
- Lead-free (gold-plated wire lead only)

- All welded construction
- Wire leads, gold-plated or solder-coated
- Matched seal for superior hermeticity
- Gold-plated contact assembly
- Modernized assembly process
- Advanced cleaning techniques

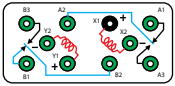
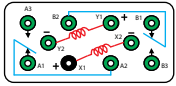
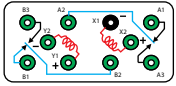
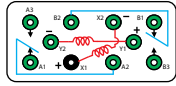
Relay Type	Part No.	Nominal Coil				Contact Load Rating	
		Voltage (Vdc)	Resistance (Ω)	Set & Reset Voltage (Vdc)			
				Min.	Max.		
DPDT Magnetic-Latching							
<b>Vibration</b>							
30G, 10-2500 Hz (Sinusoidal)							
<b>Shock</b>							
100G, 6 msec half-sine (Specified Pulse)							
<b>Temperature</b>							
Operating & Storage: -65°C to +125°C							
		<b>255</b>	5	45	1.0	3.8	Resistive: 2A/28Vdc Inductive: 0.75A/28Vdc (320mH) Intermediate Current: 0.1A/28Vdc Lamp: 0.16A/28Vdc Low Level: 10 to 50 uA/10 to 50 mV
		<b>256</b>	6	63	1.3	4.5	
		<b>257</b>	12	254	2.6	9.0	
		<b>258</b>	26	1000	5.2	18.0	
			26	1000	5.2	18.0	
		255					
		256					
		257					
		258					



## Series ER421 Electromechanical Relays

The magnetic-latching TO-5 relay, originally conceived and developed by Teledyne, has become one of the industry standards for low-level switching from dry circuit to 1 ampere. Designed for high-density PC board mounting, its small size and low coil power dissipation make the ER421 relay one of the most versatile ultraminiature relays available.

The Series ER421D and ER421DD utilize discrete silicon diodes for coil suppression and polarity reversal protection.

The Series ER421 magnetic-latching relays are ideally suited for applications where coil power dissipation must be minimized. The relays can be operated with a short duration pulse. After the contacts have transferred, no external holding power is required. The magnetic-latching feature of the Series ER421 provides a "memory" capability, since the relays will not reset upon removal of coil power.

- All welded construction
- Unique uni-frame design providing high magnetic efficiency and mechanical rigidity
- High force/mass ratio for resistance to shock and vibration
- Precious metal alloy contact material with gold plating assures excellent high current and dry circuit switching capabilities

Relay Type	Part No.	Nominal Coil			Contact Load Rating	
		Voltage (Vdc)	Resistance (Ω)	Set & Reset Voltage (Vdc)		
SPDT Magnetic-Latching						
<b>Diode Options</b>						
D = Internal diode for coil transient suppression						
DD = Internal diode for coil transient suppression and polarity reversal protection						
<b>Vibration</b>						
30 g's to 3000 Hz						
<b>Shock</b>						
100 g's 6 msec, half-sine						
<b>Acceleration</b>						
50 g's						
<b>Temperature</b>						
Operating & Storage: -65°C to +125°C						
		<b>ER421</b>	5	61	3.5	Resistive: 1A/28Vdc Inductive: 200mA/28Vdc (320mH) Lamp: 100mA/28Vdc Low Level: 10 to 50 uA/10 to 50 mV
			6	120	4.5	
			9	280	6.8	
			12	500	9.0	
			18	1130	13.5	
		<b>ER421D</b>	26	2000	18.0	
			5	61	3.7	Resistive: 1A/28Vdc Inductive: 200mA/28Vdc (320mH) Lamp: 100mA/28Vdc Low Level: 10 to 50 uA/10 to 50 mV
			6	120	4.5	
			9	280	6.8	
			12	500	9.0	
			18	1130	13.5	
		<b>ER421DD</b>	26	2000	18.0	
			5	48	4.5	Resistive: 1A/28Vdc Inductive: 200mA/28Vdc (320mH) Lamp: 100mA/28Vdc Low Level: 10 to 50 uA/10 to 50 mV
			6	97	5.5	
			9	280	7.8	
			12	500	10.0	
			18	1130	14.5	
			26	2000	19.0	

\*See Schematics on Page 21



# ESTABLISHED RELIABILITY T<sup>2</sup>R RELAYS

## Series ER420 & ER422 Electromechanical Relays

The magnetic-latching TO-5 relay, originally conceived and developed by Teledyne, has become one of the industry standards for low-level switching from dry circuit to 1 ampere. Designed for high-density PC board mounting, its small size and low coil power dissipation make the ER420 & ER422 relays some of the most versatile ultraminiature relays available.

The Series ER420D/ER422D and ER420DD/ER422DD utilize discrete silicon diodes for coil suppression and polarity reversal protection.

The Series ER420/ER422 magnetic-latching relays are ideally suited for applications where coil power dissipation must be minimized. The relays can be operated with a short duration pulse. After the contacts have transferred, no external holding power is required. The magnetic-latching feature of the Series ER420/ER422 relays provide a "memory" capability, since the relays will not reset upon removal of coil power.

- All welded construction
- Unique uni-frame design providing high magnetic efficiency and mechanical rigidity
- High force/mass ratio for resistance to shock and vibration
- Precious metal alloy contact material with gold plating assures excellent high current and dry circuit switching capabilities

Relay Type	Part No.	Nominal Coil			Contact Load Rating
		Voltage (Vdc)	Resistance (Ω)	Set & Reset Voltage (Vdc)	
DPDT Magnetic-Latching					
<b>Grounding Options</b>					
420 = Individual					Resistive: 1A/28Vdc
422 = Common					Inductive: 200mA/28Vdc (320mH)
					Lamp: 100mA/28Vdc
<b>Diode Options</b>					
D = Internal diode for coil transient suppression					Low Level: 10 to 50 uA/10 to 50 mV
DD = Internal diode for coil transient suppression and polarity reversal protection					
<b>Vibration</b>		<b>Shock</b>			
30 g's to 3000 Hz	100 g's 6 msec, half-sine				
<b>Acceleration</b>		<b>Temperature</b>			
50 g's	Operating & Storage: -65°C to +125°C				

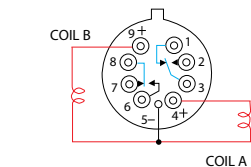

ER420

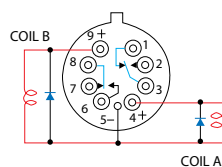

ER420D

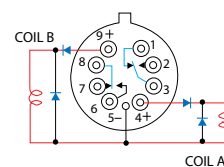

ER420DD

Schematics Shown with Coil A Last Energized  
Schematics as viewed from terminals

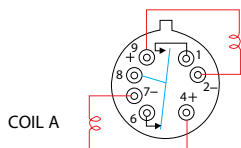

ER421

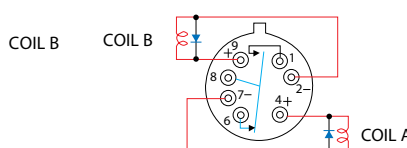

ER421D

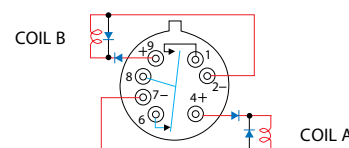

ER421DD

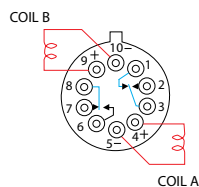

ER422

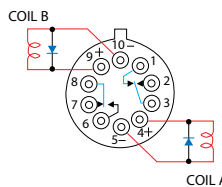

ER422D

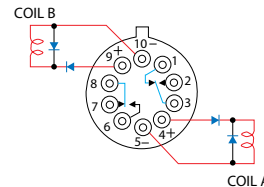

ER422DD

# MILITARY QUALIFIED (JAN) RELAYS





## Series J114 Electromechanical Relays

The Series J114 Centigrad® relay is an ultraminiature, hermetically sealed, armature relay. Its low profile height .275" (7 mm) and .100" (2.54 mm) grid spaced terminals, which precludes the need for spreader pads, make it ideal for applications where extreme packaging density and/or close PC board spacing are required. The basic design and internal construction are similar to the standard Teledyne DPDT TO-5 relay (e.g., Series J412).

The Series J114D and J114DD relays have internal discrete silicon diodes for coil suppression and polarity reversal protection.

By virtue of its inherently low intercontact capacitance and contact circuit losses, the J114 relay has proven to be an excellent ultraminiature RF switch for frequency ranges well into the UHF spectrum. A typical RF application for the J114 relay is in handheld radio transceivers, wherein the combined features of good RF performance, small size, low coil power dissipation and high reliability make it a preferred method of Transmit-Receive switching.

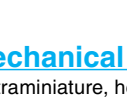
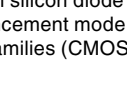
- All welded construction
- Unique uni-frame design providing high magnetic efficiency and mechanical rigidity
- High force/mass ratio for resistance to shock and vibration
- Precious metal alloy contact material with gold plating assures excellent high current and dry circuit switching capabilities



Relay Type		Part No.	Nominal Coil				Contact Load Rating	
DPDT Non-Latching			Voltage (Vdc)	Resistance (Ω)	P.U.V (Vdc) (max.)	D.O.V (Vdc)		
Diode Options						min.		max.
D = Internal diode for coil transient suppression		 <b>J114</b> (M39016/17)	5	50	3.5	0.14	2.3	Resistive: 1A/28Vdc Inductive: 200mA/28Vdc (320mH) Lamp: 100mA/28Vdc
DD = Internal diode for coil transient suppression and polarity reversal protection			9	220	6.8	0.35	4.9	
Vibration		 <b>J114DD</b> (M39016/18)	12	390	9.0	0.41	6.5	Low Level: 10 to 50 uA/10 to 50 mV
Shock			18	880	13.5	0.59	10.0	
30 g's to 3000 Hz		 <b>J114DD</b> (M39016/18)	26	1560	18.0	0.89	13.0	Resistive: 1A/28Vdc Inductive: 200mA/28Vdc (320mH) Lamp: 100mA/28Vdc
75 g's 6 msec, half-sine			5	39	4.0	0.6	2.8	
Acceleration		 <b>J114DD</b> (M39016/18)	6	78	5.0	0.7	3.4	Low Level: 10 to 50 uA/10 to 50 mV
Temperature			9	220	7.8	0.8	5.3	
50 g's		 <b>J114DD</b> (M39016/18)	12	390	10.0	0.9	6.5	Low Level: 10 to 50 uA/10 to 50 mV
Operating & Storage: -65°C to +125°C			18	880	14.5	1.1	10.0	
		 <b>J114DD</b> (M39016/18)	26	1560	19.0	1.4	13.0	

## Series J116C Electromechanical Relays

The J116C Centigrad® relay is an ultraminiature, hermetically sealed, armature relay capable of being directly driven by most IC logic families. Its low profile height and .100" (2.54 mm) grid spaced terminals, which preclude the need for spreader pads, make it ideal for applications where extreme packaging density and/or close PC board spacing are required.

The Series J116C utilizes an internal silicon diode for coil suppression, a Zener diode to protect the MOSFET gate input, and an N-channel enhancement mode MOSFET chip, which enables direct relay interfacing with most Microprocessor and IC logic families (CMOS, TTL and MOS).

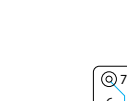
- All welded construction
- Unique uni-frame design providing high magnetic efficiency and mechanical rigidity
- High force/mass ratio for resistance to shock and vibration

Relay Type		Part No.	Nominal Coil				Contact Load Rating	
DPDT Non-Latching			Voltage (Vdc)	Coil Current (mA)		Operating Power (mW)		P.U.V (Vdc) (max.)
CMOS Feature				Min.	Max.			
Internal power MOSFET driver, Zener diode gate protection, and diode coil suppression		 <b>J116C</b> (M28776/6)	5	96.5	132.3	641	4.0	Resistive: 1A/28Vdc Inductive: 200mA/28Vdc (320mH) Lamp: 100mA/28Vdc
Vibration			6	60.3	83.9	462	4.9	
Shock		 <b>J116C</b> (M28776/6)	9	33.1	47.1	368	7.3	Low Level: 10 to 50 uA/10 to 50 mV
30 g's to 3000 Hz			12	24.9	36.1	369	9.8	
75 g's 6 msec, half-sine		 <b>J116C</b> (M28776/6)	18	16.1	24.1	368	14.6	
Acceleration			26	12.9	19.9	450	19.5	
50 g's		 <b>J116C</b> (M28776/6)						
Operating & Storage: -65°C to +125°C								

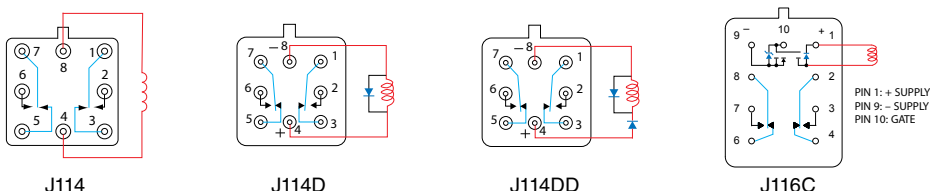

P.U.V = Pick-Up Voltage  
D.O.V = Drop-Out Voltage

Schematics as viewed from terminals

# MILITARY QUALIFIED (JAN) RELAYS



## Series J134 Electromechanical Relays

The J134 sensitive Centigrad® relay retains the same features as the J114 standard Centigrad® relay with only a minimal increase in profile height .375" (9.53 mm). Its .100" (2.54 mm) grid spaced terminals, which preclude the need for spreader pads, and its low profile make the J134 relay ideal for applications where high packaging density is important.

The Series J134D and J134DD have internal discrete silicon diodes for coil suppression and polarity reversal protection.

The sensitive J134 Centigrad® relay has a high resistance coil, thus requiring extremely low operating power (200 mw typical). The advantages of reduced heat dissipation and power supply demands are a plus.

- All welded construction
- Unique uni-frame design providing high magnetic efficiency and mechanical rigidity
- High force/mass ratio for resistance to shock and vibration
- Precious metal alloy contact material with gold plating assures excellent high current and dry circuit switching capabilities

Relay Type		Part No.	Nominal Coil				Contact Load Rating	
Diode Options			Voltage (Vdc)	Resistance (Ω)	P.U.V (Vdc) (max.)	D.O.V (Vdc)		
						min.	max.	
DPDT Non-Latching		 <b>J134</b> (M39016/41)	5	100	3.5	0.12	2.5	Resistive: 1A/28Vdc Inductive: 200mA/28Vdc (320mH) Lamp: 100mA/28Vdc Low Level: 10 to 50 uA/10 to 50 mV
D = Internal diode for coil transient suppression			6	200	4.5	0.18	3.2	
DD = Internal diode for coil transient suppression and polarity reversal protection			9	400	6.8	0.35	4.9	
Vibration			12	800	9.0	0.41	6.5	
Shock			18	1600	13.5	0.59	10.0	
Temperature			26	3200	18.0	0.89	13.0	
30 g's		 <b>J134DD</b> (M39016/43)	5	64	3.7	0.7	2.6	Resistive: 1A/28Vdc Inductive: 200mA/28Vdc (320mH) Lamp: 100mA/28Vdc Low Level: 10 to 50 uA/10 to 50 mV
75 g's 6 msec, to 3000 Hz			6	125	4.8	0.8	3.0	
Acceleration			9	400	8.0	0.9	4.5	
Temperature			12	800	11.0	1.0	5.8	
Operating & Storage: -65°C to +125°C			18	1600	14.5	1.1	9.0	
50 g's			26	3200	19.0	1.3	13.0	

## Series J136C Electromechanical Relays

The sensitive J136C Centigrad® relay is an ultraminiature, hermetically sealed, armature relay capable of being directly driven by most IC logic families. Its low profile height and .100" (2.54 mm) grid spaced terminals, which precludes the need for spreader pads, make it ideal for applications where extreme packaging density and/or close PC board spacing are required.

The sensitive J136C Centigrad® relay has a high resistance coil, thus requiring extremely low operating power (200 mW, typical). The advantages of reduced heat dissipation and power supply demands are a plus.

The sensitive Series J136C utilizes an internal silicon diode for coil suppression, a Zener diode to protect the MOSFET gate input, and an N-channel enhancement-mode MOSFET chip that enables direct relay interfacing with most microprocessor and IC logic families (CMOS, TTL and MOS).

- All welded construction
- Unique uni-frame design providing high magnetic efficiency and mechanical rigidity
- High force/mass ratio for resistance to shock and vibration
- Precious metal alloy contact material with gold plating assures excellent high current and dry circuit switching capabilities

Relay Type		Part No.	Nominal Coil				Contact Load Rating	
CMOS Feature			Voltage (Vdc)	Coil Current (mA)		Operating Power (mW)		P.U.V (Vdc) (max.)
		Min.		Max.				
DPDT Non-Latching		 <b>J136C</b> (M28776/7)	5	43.0	56.0	250	4.0	Resistive: 1A/28Vdc Inductive: 200mA/28Vdc (320mH) Lamp: 100mA/28Vdc Low Level: 10 to 50 uA/10 to 50 mV
Internal power MOSFET driver, Zener diode gate protection, and diode coil suppression			6	27.0	33.0	180	4.9	
Vibration			9	17.8	26.4	203	7.3	
Shock			12	11.3	17.7	180	9.8	
Acceleration			18	8.4	13.8	203	14.6	
Temperature			26	5.8	10.2	219	19.5	
30 g's								PIN 1: SUPPLY PIN 9: - SUPPLY PIN 10: GATE
75 g's 6 msec, to 3000 Hz								
Operating & Storage: -65°C to +125°C								
50 g's								

Schematics as viewed from terminals

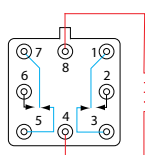

J134

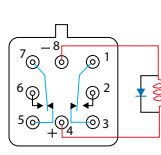

J134D

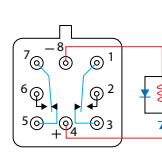

J134DD

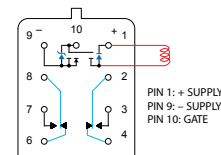

J136C

P.U.V = Pick-Up Voltage  
D.O.V = Drop-Out Voltage

# MILITARY QUALIFIED (JAN) RELAYS

## Series J411 & J431 Electromechanical Relays

The TO-5 relay, originally conceived and developed by Teledyne, has become one of the industry standards for low-level switching from dry circuit to 1 ampere. Designed specifically for high-density PC board mounting, its small size and low coil power dissipation make the J411 relay one of the most versatile ultraminiature relays available.

The Series J411D and J411DD relays have internal discrete silicon diodes for coil suppression and polarity reversal protection. The hybrid J411T relay features an internal silicon suppression diode and transistor driver. This hybrid package reduces required PC board floor space by reducing the number of external components needed to drive the relay.

The sensitive J431 relay has a high resistance coil, thus requiring extremely low operating power (150 mw typical). The advantages of reduced heat dissipation and power supply demands are a plus.

The Series J431D and J431DD relays have internal discrete silicon diodes for coil suppression and polarity reversal protection. The hybrid J431T relay features an internal silicon suppression diode and transistor driver. This hybrid package reduces required PC board floor space by reducing the number of external components needed to drive the relay.

- All welded construction
- Unique uni-frame design providing high magnetic efficiency and mechanical rigidity
- High force/mass ratio for resistance to shock and vibration
- Precious metal alloy contact material with gold plating assures excellent high current and dry circuit switching capabilities

Relay Type		Part No.	Nominal Coil				Contact Load Rating	
Coil Type			Voltage (Vdc)	Resistance (Ω)	P.U.V (Vdc) (max.)	D.O.V (Vdc)		
Diode Options					min.	max.		
SPDT Non-Latching								
J411 = Standard Coil			5	63	3.7	0.15	2.4	Resistive: 1A/28Vdc
J431 = Sensitive Coil			6	125	4.5	0.18	2.8	Inductive: 200mA/28Vdc (320mH)
D = Internal diode for coil transient suppression		J411 (M39016/7)	9	280	6.8	0.35	4.2	Lamp: 100mA/28Vdc
			12	500	9.0	0.40	5.6	Low Level: 10 to 50 uA/10 to 50 mV
DD = Internal diode for coil transient suppression and polarity reversal protection		J411DD (M39016/23)	18	1130	13.5	0.58	8.4	
			26	2000	18.0	0.89	10.4	
T = Internal transistor drive and coil transient suppression diode		J411DD (M39016/24)	5	50	4.5	0.15	2.4	Resistive: 1A/28Vdc
			6	98	5.5	0.18	2.8	Inductive: 200mA/28Vdc (320mH)
Vibration		J411DD (M39016/24)	9	280	7.8	0.35	4.2	Lamp: 100mA/28Vdc
			12	500	10.0	0.40	5.6	Low Level: 10 to 50 uA/10 to 50 mV
Shock		J411DD (M39016/24)	18	1130	14.5	0.58	8.4	
			26	2000	19.0	0.89	10.4	
Acceleration		J411T (M28776/5)	5	63	3.9	0.15	2.4	Resistive: 1A/28Vdc
			6	125	5.2	0.18	2.8	Inductive: 200mA/28Vdc (320mH)
Temperature		J411T (M28776/5)	9	280	7.8	0.35	4.2	Lamp: 100mA/28Vdc
			12	500	10.0	0.40	5.6	Low Level: 10 to 50 uA/10 to 50 mV
Operating & Storage: -65°C to +125°C		J411T (M28776/5)	18	1130	14.5	0.58	8.4	
			26	2000	19.0	0.89	10.4	
50 g's		J431 (M39016/10)	5	125	3.7	0.15	2.0	Resistive: 1A/28Vdc
			6	255	4.5	0.18	2.8	Inductive: 200mA/28Vdc (320mH)
30 g's to 3000 Hz		J431 (M39016/10)	9	630	6.8	0.35	4.2	Lamp: 100mA/28Vdc
			12	1025	9.0	0.41	5.6	Low Level: 10 to 50 uA/10 to 50 mV
75 g's 6 msec, half-sine		J431D (M39016/25)	18	2300	13.5	0.58	8.4	
			26	4000	18.0	0.89	10.4	
50 g's		J431DD (M39016/26)	5	100	4.5	0.15	2.4	Resistive: 1A/28Vdc
			6	200	5.5	0.18	2.8	Inductive: 200mA/28Vdc (320mH)
Operating & Storage: -65°C to +125°C		J431DD (M39016/26)	9	630	7.8	0.35	4.2	Lamp: 100mA/28Vdc
			12	1025	10.0	0.40	5.6	Low Level: 10 to 50 uA/10 to 50 mV
50 g's		J431DD (M39016/26)	18	2300	14.5	0.58	8.4	
			26	4000	19.0	0.89	10.4	
50 g's		J431T (M28776/4)	5	125	3.6	0.15	2.0	Resistive: 1A/28Vdc
			6	255	4.8	0.18	2.8	Inductive: 200mA/28Vdc (320mH)
50 g's		J431T (M28776/4)	9	630	7.8	0.35	4.2	Lamp: 100mA/28Vdc
			12	1025	10.0	0.41	5.6	Low Level: 10 to 50 uA/10 to 50 mV
50 g's		J431T (M28776/4)	18	2300	14.5	0.58	8.4	
			26	4000	19.0	0.89	10.4	

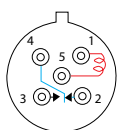

J411  
J431

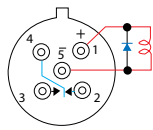

J411D  
J431D

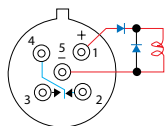

J411DD  
J431DD

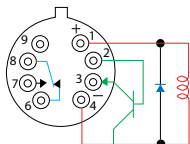

J411T  
J431T

P.U.V = Pick-Up Voltage  
D.O.V = Drop-Out Voltage

Schematics as viewed from terminals

# MILITARY QUALIFIED (JAN) RELAYS

## Series J412 & J432 Electromechanical Relays







The TO-5 relay, originally conceived and developed by Teledyne, has become one of the industry standards for low-level switching from dry circuit to 1 ampere. Designed specifically for high-density PC board mounting, its small size and low coil power dissipation make the J412 relay one of the most versatile ultraminiature relays available.

The Series J412D and J412DD relays have internal discrete silicon diodes for coil suppression and polarity reversal protection. The hybrid J412T relay features an internal silicon suppression diode and transistor driver. This hybrid package reduces required PC board floor space by reducing the number of external components needed to drive the relay.

The sensitive J432 relay has a high resistance coil, thus requiring extremely low operating power (200 mw typical). The advantages of reduced heat dissipation and power supply demands are a plus.

The Series J432D and J432DD relays have internal discrete silicon diodes for coil suppression and polarity reversal protection. The hybrid J432T relay features an internal silicon suppression diode and transistor driver. This hybrid package reduces required PC board floor space by reducing the number of external components needed to drive the relay.

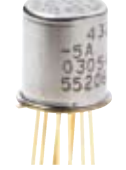
- All welded construction
- Unique uni-frame design providing high magnetic efficiency and mechanical rigidity
- High force/mass ratio for resistance to shock and vibration
- Precious metal alloy contact material with gold plating assures excellent high current and dry circuit switching capabilities

Relay Type		Part No.	Nominal Coil				Contact Load Rating	
Coil Type			Voltage (Vdc)	Resistance (Ω)	P.U.V (Vdc) (max.)	D.O.V (Vdc)		
Diode Options								
Vibration								
Shock								
Acceleration								
Temperature								
DPDT Non-Latching								
J412 = Standard Coil		 <b>J412</b> (M39016/9)	5	50	3.5	0.14	2.3	Resistive: 1A/28Vdc Inductive: 200mA/28Vdc (320mH) Lamp: 100mA/28Vdc Low Level: 10 to 50 uA/10 to 50 uA
J432 = Sensitive Coil			6	98	4.5	0.18	3.2	
D = Internal diode for coil transient suppression			9	220	6.8	0.35	4.9	
DD = Internal diode for coil transient suppression and polarity reversal protection			12	390	9.0	0.41	6.5	
T = Internal transistor drive and coil transient suppression diode			18	880	13.5	0.59	10.0	
		26	1560	18.0	0.89	13.0		
		 <b>J412DD</b> (M39016/20)	5	39	3.9	0.6	2.8	Resistive: 1A/28Vdc Inductive: 200mA/28Vdc (320mH) Lamp: 100mA/28Vdc Low Level: 10 to 50 uA/10 to 50 uA
			6	78	5.2	0.7	3.4	
			9	220	7.8	0.8	5.3	
			12	390	10.0	0.9	6.5	
			18	880	14.5	1.1	10.0	
		26	1560	19.0	1.4	13.0		
		 <b>J412T</b> (M28776/1)	5	50	3.5	0.14	2.3	Resistive: 1A/28Vdc Inductive: 200mA/28Vdc (320mH) Lamp: 100mA/28Vdc Low Level: 10 to 50 uA/10 to 50 mV
			6	98	4.5	0.18	3.2	
			9	220	6.8	0.35	4.9	
			12	390	9.0	0.41	6.5	
			18	880	13.5	0.59	10.0	
		26	1560	18.0	0.89	13.0		
		 <b>J432</b> (M39016/11)	5	100	3.5	0.14	2.5	Resistive: 1A/28Vdc Inductive: 200mA/28Vdc (320mH) Lamp: 100mA/28Vdc Low Level: 10 to 50 uA/10 to 50 mV
			6	200	4.5	0.18	3.2	
			9	400	6.8	0.35	4.9	
			12	850	9.0	0.41	6.5	
			18	1600	13.5	0.59	10.0	
		26	3300	18.0	0.89	13.0		
		 <b>J432DD</b> (M39016/21)	5	64	3.7	0.7	2.6	Resistive: 1A/28Vdc Inductive: 200mA/28Vdc (320mH) Lamp: 100mA/28Vdc Low Level: 10 to 50 uA/10 to 50 mV
			6	125	4.8	0.8	3.0	
			9	400	8.0	0.9	4.5	
			12	850	11.0	1.0	5.8	
			18	1600	14.5	1.1	9.0	
		26	3300	19.0	1.3	13.0		
		 <b>J432T</b> (M28776/3)	5	100	3.6	0.14	2.5	Resistive: 1A/28Vdc Inductive: 200mA/28Vdc (320mH) Lamp: 100mA/28Vdc Low Level: 10 to 50 uA/10 to 50 mV
			6	200	4.8	0.18	3.2	
			9	400	7.8	0.35	4.9	
			12	850	11.0	0.41	6.5	
			18	1600	14.5	0.59	10.0	
		26	3300	19.0	0.89	13.0		

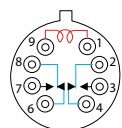

J412  
J432

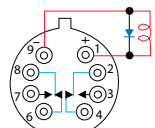

J412D  
J432D

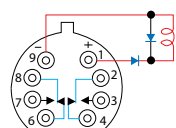

J412DD  
J432DD

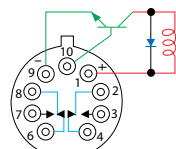

J412T  
J432T

Schematics as viewed from terminals

P.U.V = Pick-Up Voltage  
D.O.V = Drop-Out Voltage



# MILITARY QUALIFIED (JAN) RELAYS

## Series J255 Electromechanical Relays

The Series J255 is an industry-standard, half-size, latching crystal can relay. It has a wide range of switching capabilities ranging from low level to 2 amps. The Series J255 latching relay configuration is double-pole double-throw (DPDT), so the relay offers excellent switching density and versatility.

Half-Size Crystal Can Features:

- Low level to 2 amps
- Wide range of switching capabilities
- Smallest relay package capable of switching 2 amps
- Modernized assembly process
- Qualified to MIL-PRF39016/45
- Lead-free (gold-plated wire lead only)

- All welded construction
- Wire leads, gold-plated or solder-coated
- Matched seal for superior hermeticity
- Gold-plated contact assembly
- Modernized assembly process
- Advanced cleaning techniques

Relay Type	Part No.	Nominal Coil				Contact Load Rating
		Voltage (Vdc)	Resistance (Ω)	Set & Reset Voltage (Vdc)		
				Min.	Max.	
DPDT Magnetic-Latching	 <b>J255</b> (M39016/45)	5	45	1.0	3.8	Resistive: 2A/28Vdc Inductive: 0.75A/28Vdc (320mH) Intermediate Current: 0.1A/28Vdc Lamp: 0.16A/28Vdc Low Level: 10 to 50 uA/10 to 50 mV
Vibration		6	63	1.3	4.5	
30G, 10-2500 Hz (Sinusoidal)		12	254	2.6	9.0	
Shock		26	1000	5.2	18.0	
100G, 6 msec half-sine (Specified Pulse)						
Temperature						
Operating & Storage: -65°C to +125°C						

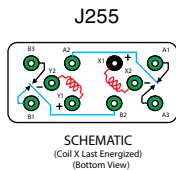



## Series J421 Electromechanical Relays

The magnetic-latching TO-5 relay, originally conceived and developed by Teledyne, has become one of the industry standards for low-level switching from dry circuit to 1 ampere. Designed for high-density PC board mounting, its small size and low coil power dissipation make the J421 relay one of the most versatile ultraminiature relays available.

The Series J421D and J421DD utilize discrete silicon diodes for coil suppression and polarity reversal protection.

The Series J421 magnetic-latching relays are ideally suited for applications where coil power dissipation must be minimized. The relays can be operated with a short duration pulse. After the contacts have transferred, no external holding power is required. The magnetic-latching feature of the Series J421 provides a "memory" capability, since the relays will not reset upon removal of coil power.

- All welded construction
- Unique uni-frame design providing high magnetic efficiency and mechanical rigidity
- High force/mass ratio for resistance to shock and vibration
- Precious metal alloy contact material with gold plating assures excellent high current and dry circuit switching capabilities

Relay Type	Part No.	Nominal Coil			Contact Load Rating
		Voltage (Vdc)	Resistance (Ω)	Set & Reset Voltage (Vdc)	
SPDT Magnetic-Latching	 <b>J421</b> (M39016/8)	5	61	3.5	Resistive: 1A/28Vdc Inductive: 200mA/28Vdc (320mH) Lamp: 100mA/28Vdc Low Level: 10 to 50 uA/10 to 50 mV
Diode Options		6	120	4.5	
D = Internal diode for coil transient suppression		9	280	6.8	
DD = Internal diode for coil transient suppression and polarity reversal protection		12	500	9.0	
		18	1130	13.5	
Vibration	 <b>J421D</b> (M39016/27)	5	61	3.7	Resistive: 1A/28Vdc Inductive: 200mA/28Vdc (320mH) Lamp: 100mA/28Vdc Low Level: 10 to 50 uA/10 to 50 mV
Shock		6	120	4.5	
30 g's to 3000 Hz		9	280	6.8	
100 g's 6 msec, half-sine		12	500	9.0	
		18	1130	13.5	
Acceleration	 <b>J421DD</b> (M39016/28)	5	48	4.5	Resistive: 1A/28Vdc Inductive: 200mA/28Vdc (320mH) Lamp: 100mA/28Vdc Low Level: 10 to 50 uA/10 to 50 mV
Temperature		6	97	5.5	
50 g's		9	280	7.8	
Operating & Storage: -65°C to +125°C		12	500	10.0	
		18	1130	14.5	
	26	2000	19.0		

\*See Schematics on Page 27

MILITARY QUALIFIED (JAN)



# MILITARY QUALIFIED (JAN) RELAYS



## Series J420 & J422 Electromechanical Relays

The magnetic-latching TO-5 relay, originally conceived and developed by Teledyne, has become one of the industry standards for low-level switching from dry circuit to 1 ampere. Designed for high-density PC board mounting, its small size and low coil power dissipation make the J420 & J422 relays some of the most versatile ultraminiature relays available.

The Series J420D/J422D and J420DD/J422DD utilize discrete silicon diodes for coil suppression and polarity reversal protection.

The Series J420/J422 magnetic-latching relays are ideally suited for applications where coil power dissipation must be minimized. The relays can be operated with a short duration pulse. After the contacts have transferred, no external holding power is required. The magnetic-latching feature of the Series J420/J422 relays provide a "memory" capability, since the relays will not reset upon removal of coil power.

- All welded construction
- Unique uni-frame design providing high magnetic efficiency and mechanical rigidity
- High force/mass ratio for resistance to shock and vibration
- Precious metal alloy contact material with gold plating assures excellent high current and dry circuit switching capabilities

Relay Type		Part No.	Nominal Coil			Contact Load Rating	
DPDT Magnetic-Latching			Voltage (Vdc)	Resistance (Ω)	Set & Reset Voltage (Vdc)		
Grounding Options			J420 (M39016/12)	5	61	3.5	Resistive: 1A/28Vdc Inductive: 200mA/28Vdc (320mH) Lamp: 100mA/28Vdc Low Level: 10 to 50 uA/10 to 50 mV
J420 = Individual				6	120	4.5	
J422 = Common			J422 (M39016/12)	9	280	6.8	
Diode Options				J420D (M39016/29)	12	500	
D = Internal diode for coil transient suppression			J422D (M39016/29)	18	1130	13.5	
DD = Internal diode for coil transient suppression and polarity reversal protection			J420DD (M39016/30)	26	2000	18.0	
Vibration	Shock		J420DD (M39016/30)	5	48	4.5	Resistive: 1A/28Vdc Inductive: 200mA/28Vdc (320mH) Lamp: 100mA/28Vdc Low Level: 10 to 50 uA/10 to 50 mV
30 g's	100 g's 6 msec, to 3000 Hz			6	97	5.5	
Acceleration			J422DD (M39016/30)	9	280	7.8	
Temperature				12	500	10.0	
50 g's	Operating & Storage: -65°C to +125°C		18	1130	14.5		
			26	2000	19.0		

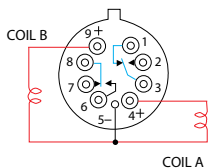

J420

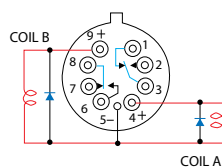

J420D

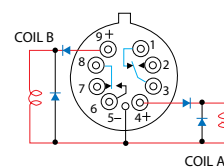

J420DD

Schematics Shown with Coil A Last Energized  
Schematics as viewed from terminals

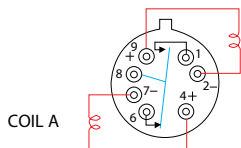

J421

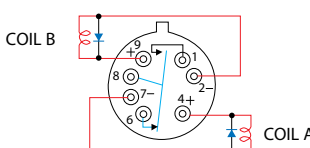

J421D

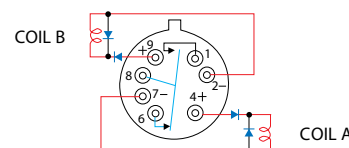

J421DD

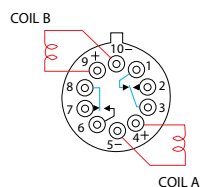

J422

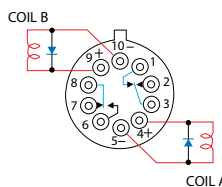

J422D

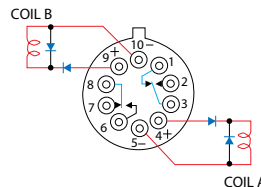

J422DD

# HIGH-PERFORMANCE RELAYS

## Series 412H, 422H & 432H Electromechanical Relays - High Temperature

The TO-5 relay, originally conceived and developed by Teledyne, has become one of the industry standards for low-level switching from dry circuit to 1 ampere. Designed for high-density PC board mounting, these TO-5 relays are some of the most versatile ultraminiature relays available because of their small size and low coil power dissipation.



The H Series high-temperature TO-5 relays are designed for reliable operation in elevated ambient temperatures up to 200°C. Special material selection and processing provide assurance of freedom from contact contamination and mechanical malfunctioning that might otherwise be caused by ultra high ambient temperature conditions.

Typical applications:

- Oil exploration (down-hole) instrumentation
- High-Temperature industrial and process control instrumentation

- All welded construction
- Unique uni-frame design providing high magnetic efficiency and mechanical rigidity
- High force/mass ratio for resistance to shock and vibration
- Precious metal alloy contact material with gold plating assures excellent high current and dry circuit switching capabilities

Relay Type
412H = DPDT Non-Latching
432H = DPDT Non-Latching
422H = DPDT Magnetic-Latching
Coil Type
412H = Standard Coil
422H = Standard Coil
432H = Sensitive Coil
Vibration
30 g's to 3000 Hz
Shock
412H = 75 g's 6 msec, half-sine
432H = 75 g's 6 msec, half-sine
422H = 100 g's
Acceleration
50 g's
Temperature
Operating & Storage: -65°C to +200°C

Part No.	Nominal Coil					Contact Load Rating
	Voltage (Vdc)	Resistance (Ω)	P.U.V (Vdc) (max.)	D.O.V (Vdc)		
				min.	max.	
 412H	5	50	4.7	0.14	2.4	Resistive: 1A/28Vdc
	6	98	5.9	0.18	3.4	Inductive: 200mA/28Vdc (320mH)
	9	220	9.0	0.35	5.1	Lamp: 100mA/28Vdc
	12	390	11.9	0.41	6.8	Low Level: 10 to 50 uA/10 to 50 mV
	18	880	17.8	0.59	10.2	
 432H	5	100	4.7	0.14	2.4	Resistive: 1A/28Vdc
	6	200	5.9	0.18	3.4	Inductive: 200mA/28Vdc (320mH)
	9	400	9.0	0.35	5.1	Lamp: 100mA/28Vdc
	12	850	11.9	0.41	6.8	Low Level: 10 to 50 uA/10 to 50 mV
	18	1600	17.8	0.59	10.2	
26	3300	24.0	0.89	13.5		

Part No.	Nominal Coil			Contact Load Rating
	Voltage (Vdc)	Resistance (Ω)	Set & Reset Voltage (Vdc)	
 422H	5	61	4.7	Resistive: 1A/28Vdc
	6	120	5.9	Inductive: 200mA/28Vdc (320mH)
	9	280	9.0	Lamp: 100mA/28Vdc
	12	500	11.9	Low Level: 10 to 50 uA/10 to 50 mV
	18	1130	17.8	
	26	2000	24.0	

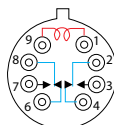

412H  
432H

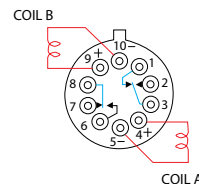

SCHEMATIC  
(Coil A Last Energized)  
422H

Schematics as viewed from terminals

P.U.V = Pick-Up Voltage

D.O.V = Drop-Out Voltage

# HIGH-PERFORMANCE RELAYS

## Series 412K & 422K Electromechanical Relays - High Shock

The TO-5 relay, originally conceived and developed by Teledyne, has become one of the industry standards for low-level switching from dry circuit to 1 ampere. Designed for high-density PC board mounting, its small size and low coil power dissipation make the TO-5 relay one of the most versatile subminiature relays available.

The K Series high-shock TO-5 relays are designed to withstand shock levels up to 4000 g's, .5 msec duration. Special material selection and construction details provide assurance that critical elements of the relay structure and mechanism will not be permanently displaced or damaged as a result of extremely high g level shocks.

Typical applications:

- Commercial avionics aircraft control
- Commercial aircraft control systems
- Transportation systems (rail/truck)

- All welded construction
- Unique uni-frame design providing high magnetic efficiency and mechanical rigidity
- High force/mass ratio for resistance to shock and vibration
- Precious metal alloy contact material with gold plating assures excellent high current and dry circuit switching capabilities

Relay Type	Part No.	Nominal Coil				Contact Load Rating	
		Voltage (Vdc)	Resistance (Ω)	P.U.V (Vdc) (max.)	D.O.V (Vdc)		
412K = DPDT Non-Latching	 <b>412K</b>	5	50	4.3	0.14	2.5	Resistive: 1A/28Vdc
422K = DPDT Magnetic-Latching		6	80	5.2	0.18	3.2	Inductive: 200mA/28Vdc (320mH)
<b>Vibration</b>		9	160	7.6	0.35	4.9	Lamp: 100mA/28Vdc
30 g's to 3000 Hz		12	300	10.0	0.41	6.5	Low Level: 10 to 50 uA/10 to 50 mV
<b>Shock</b>		18	600	14.3	0.59	10.0	
412K = 75 g's 6 msec, half-sine		26	1350	21.0	0.89	13.0	

Relay Type	Part No.	Nominal Coil			Contact Load Rating
		Voltage (Vdc)	Resistance (Ω)	Set & Reset Voltage (Vdc)	
422K = 75 g's 6 msec, half-sine	 <b>422K</b>	5	61	3.5	Resistive: 1A/28Vdc
4000 g's, 0.5 msec axial plane, half-sine		6	120	4.5	Inductive: 200mA/28Vdc (320mH)
1000 g's, 0.5 msec side planes, half-sine		9	280	6.8	Lamp: 100mA/28Vdc
422K = 100 g's 6 msec, half-sine		12	500	9.0	Low Level: 10 to 50 uA/10 to 50 mV
2100 g's, 0.5 msec axial plane, half-sine		18	1130	13.5	
750 g's, 0.5 msec side planes, half-sine		26	2000	18.0	

Acceleration
50 g's
Temperature
Operating & Storage: -65°C to +125°C

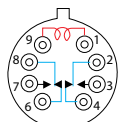

412K

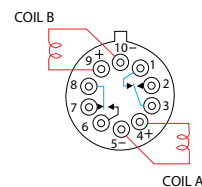

SCHEMATIC  
(Coil A Last Energized)

422K

Schematics as viewed from terminals

P.U.V = Pick-Up Voltage

D.O.V = Drop-Out Voltage

# HIGH-PERFORMANCE RELAYS

## Series 412V & 432V Electromechanical Relays - High Vibration



The 412V and 432V TO-5 relays, originally conceived and developed by Teledyne, have become the industry standards for low level switching from dry circuit to 1 ampere in high-vibration environments. Designed for high-density PC board mounting, these TO-5 relays are some of the most versatile ultraminiature relay available because of their small size and low coil power dissipation.

The V Series high-vibration relays are designed to withstand vibration levels of 250 to 380 g's at the frequencies noted, when tested on a resonant beam for 10 to 20 seconds, in the axis parallel to contact motion (x-axis), or 100 g's 10-2000 Hz for 20 minutes in the x-axis. A unique magnetic circuit prevents contact opening (chatter) in excess of 10 microseconds under vibration or shock conditions.

Typical applications:

- Avionics aircraft control
- Aircraft control systems
- Transportation systems (rail/truck)

- All welded construction
- Unique uni-frame design providing high magnetic efficiency and mechanical rigidity
- High force/mass ratio for resistance to shock and vibration
- Precious metal alloy contact material with gold plating assures excellent high current and dry circuit switching capabilities

Relay Type	Part No.	Nominal Coil					Contact Load Rating
		Voltage (Vdc)	Resistance (Ω)	P.U.V (Vdc) (max.)	D.O.V (Vdc)		
						min.	max.
DPDT Non-Latching							
<b>Coil Type</b>							
412V = Standard Coil	 <b>412V</b> <b>412DV</b>	5	50	4.6	0.14	2.3	Resistive: 1A/28Vdc Inductive: 200mA/28Vdc (320mH) Lamp: 100mA/28Vdc Low Level: 10 to 50 uA/10 to 50 mV
432V = Sensitive Coil		6	70	5.5	0.18	3.2	
<b>Diode Options</b>		9	155	8.2	0.35	4.9	
D = Internal diode for coil transient suppression		12	235	11.0	0.41	6.5	
DD = Internal diode for coil transient suppression and polarity reversal protection		18	610	16.5	0.59	10.0	
		26	1130	22.0	0.89	13.0	
	 <b>412DDV</b>	5	33	4.6	0.6	2.8	Resistive: 1A/28Vdc Inductive: 200mA/28Vdc (320mH) Lamp: 100mA/28Vdc Low Level: 10 to 50 uA/10 to 50 mV
		6	44	5.5	0.7	3.4	
		9	125	8.2	0.8	5.3	
		12	215	11.0	0.9	6.5	
		18	470	16.5	1.1	10.0	
		26	1050	22.0	1.4	13.0	
	 <b>432V</b> <b>432DV</b>	5	80	4.6	0.14	2.5	Resistive: 1A/28Vdc Inductive: 200mA/28Vdc (320mH) Lamp: 100mA/28Vdc Low Level: 10 to 50 uA/10 to 50 mV
		6	120	5.5	0.18	3.2	
		9	240	8.2	0.35	4.9	
		12	480	11.0	0.41	6.5	
		18	950	16.5	0.59	10.0	
		26	1900	22.0	0.89	13.0	
<b>Vibration</b>							
250 g's at 140 ±5 Hz							
350 g's at 170 ±5 Hz							
380 g's at 200 ±5 Hz							
<b>Shock</b>							
150 g's 11 msec, half-sine							
<b>Acceleration</b>							
50 g's							
<b>Temperature</b>							
Operating & Storage:							
-65°C to +125°C							

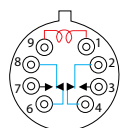

412V  
432V

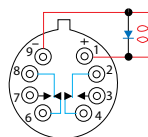

412DV  
432DV

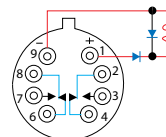

412DDV

Schematics as viewed from terminals

P.U.V = Pick-Up Voltage

D.O.V = Drop-Out Voltage

# APPENDIX: SIGNAL INTEGRITY EYE DIAGRAMS

## SERIES RF100

Normally Closed

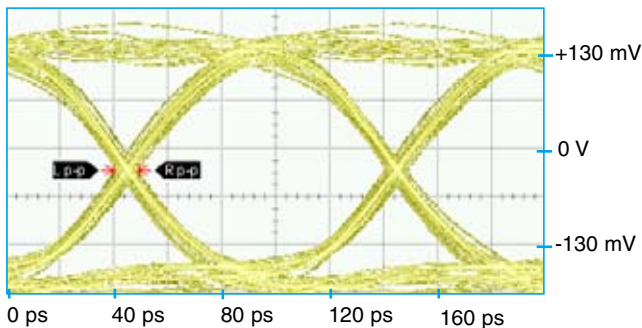

Eye Height	Eye Width	SNR	Jitter <sub>p-p</sub>
233.7 mV	88.88 ps	13.01	9.33 ps

Normally Open

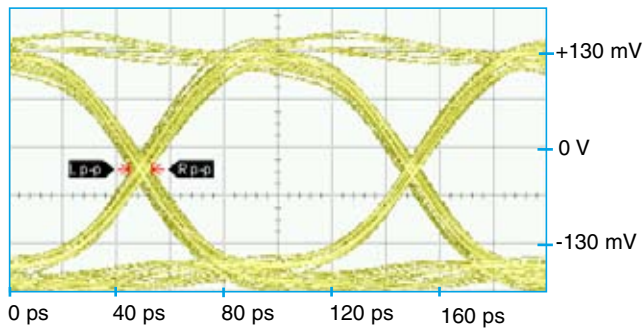

Eye Height	Eye Width	SNR	Jitter <sub>p-p</sub>
217.1 mV	88.05 ps	11.55	8.44 ps

## SERIES GRF100

Normally Closed

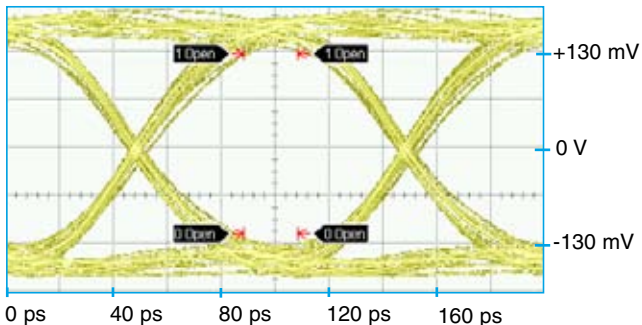

Eye Height	Eye Width	SNR	Jitter <sub>p-p</sub>
242.5 mV	90.09 ps	14.20	8.44 ps

Normally Open

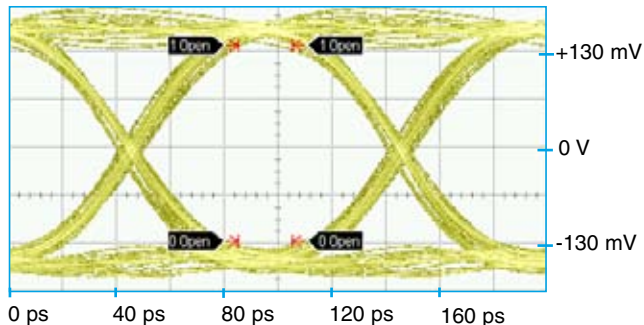

Eye Height	Eye Width	SNR	Jitter <sub>p-p</sub>
263.6 mV	87.29 ps	20.23	9.78 ps

## SERIES SGRF100

Normally Closed

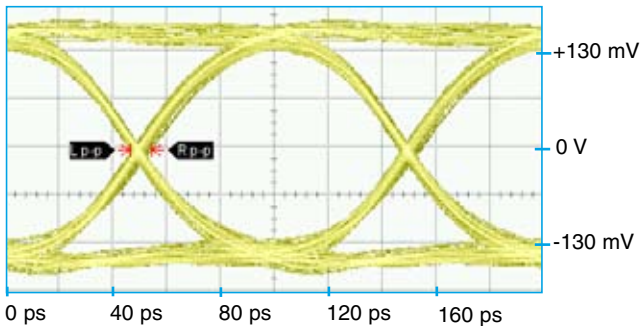

Eye Height	Eye Width	SNR	Jitter <sub>p-p</sub>
251.5 mV	92.04 ps	15.11	8.00 ps

Normally Open

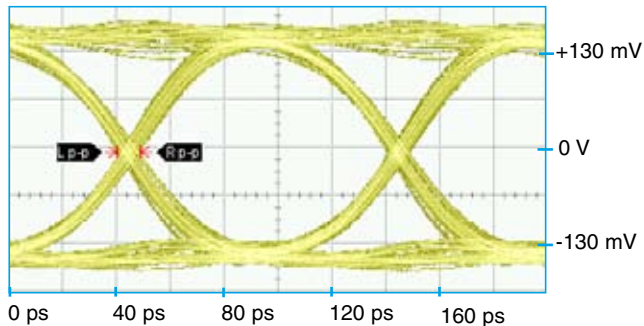

Eye Height	Eye Width	SNR	Jitter <sub>p-p</sub>
261.2 mV	87.64 ps	18.20	8.44 ps



# APPENDIX: SIGNAL INTEGRITY EYE DIAGRAMS

## SERIES GRF172

Normally Closed

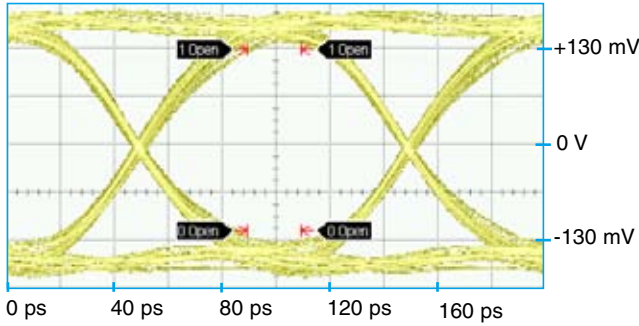

Eye Height	Eye Width	SNR	Jitter <sub>P-P</sub>
246.1 mV	92.45 ps	14.59	6.22 ps

Normally Open

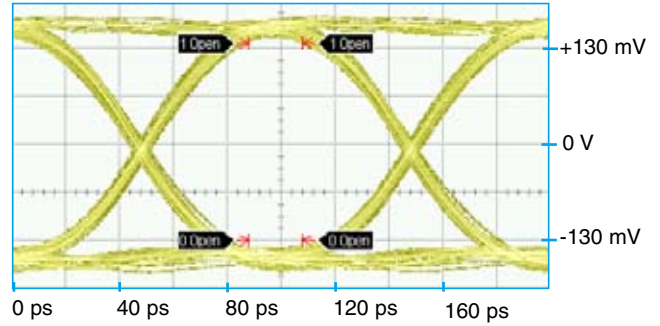

Eye Height	Eye Width	SNR	Jitter <sub>P-P</sub>
268.2 mV	90.87 ps	21.62	7.56 ps

## SERIES RF300/RF303

Normally Closed

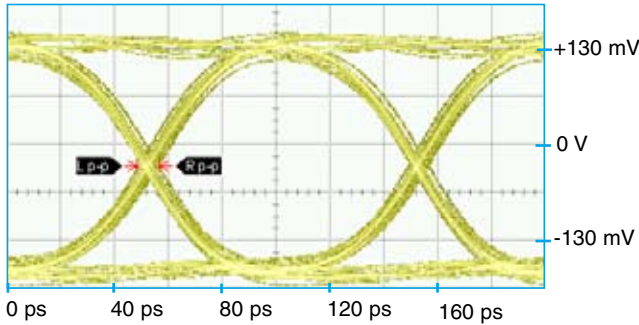

Eye Height	Eye Width	SNR	Jitter <sub>P-P</sub>
254.7 mV	90.38 ps	18.52	8.44 ps

Normally Open

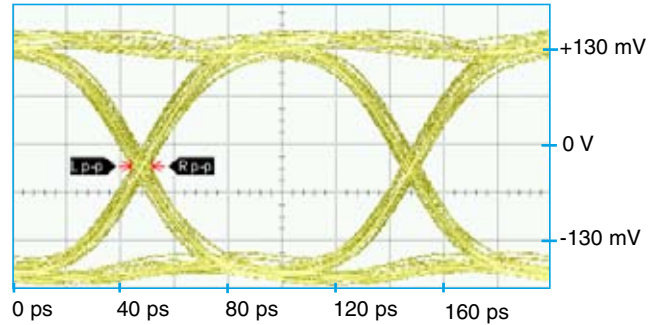

Eye Height	Eye Width	SNR	Jitter <sub>P-P</sub>
250.9 mV	88.21 ps	16.84	8.00 ps

## SERIES GRF300/GRF303

Normally Closed

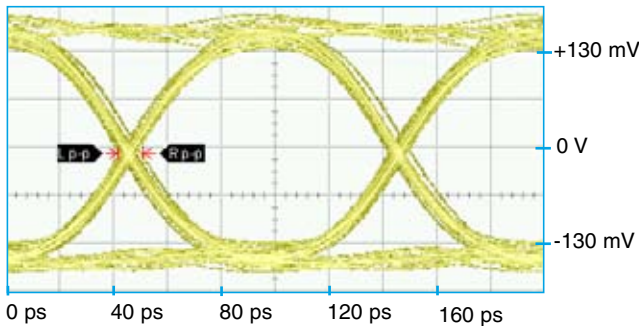

Eye Height	Eye Width	SNR	Jitter <sub>P-P</sub>
237.6 mV	90.08 ps	14.19	9.33 ps

Normally Open

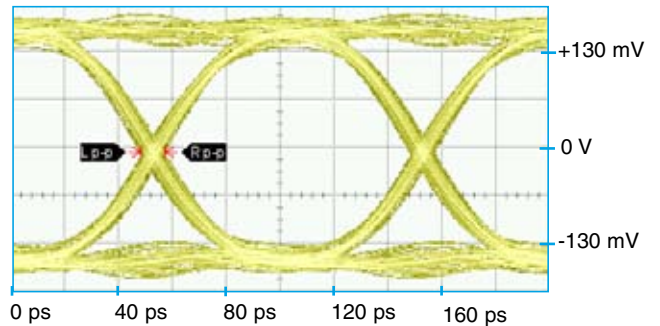

Eye Height	Eye Width	SNR	Jitter <sub>P-P</sub>
255.2 mV	88.93 ps	17.74	8.89 ps



# APPENDIX: SIGNAL INTEGRITY EYE DIAGRAMS

## SERIES SGRF300/SGRF303

Normally Closed

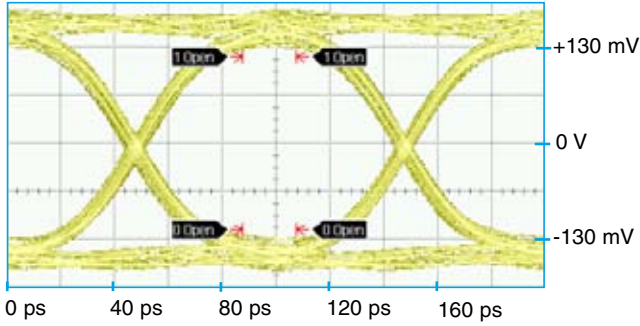

Eye Height	Eye Width	SNR	Jitter <sub>P-P</sub>
233.3 mV	89.08 ps	13.18	7.56 ps

Normally Open

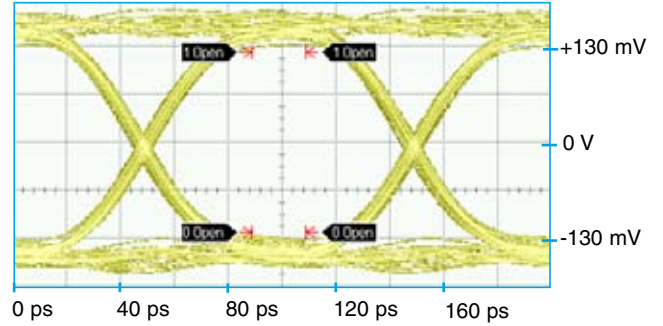

Eye Height	Eye Width	SNR	Jitter <sub>P-P</sub>
243.1 mV	90.29 ps	15.21	7.56 ps

## SERIES SRF300/SRF303

Normally Closed

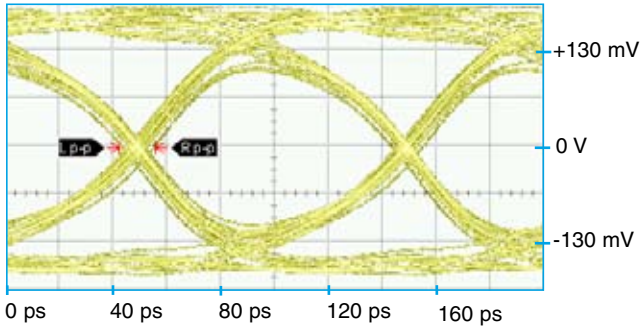

Eye Height	Eye Width	SNR	Jitter <sub>P-P</sub>
137.9 mV	85.83 ps	6.31	13.33 ps

Normally Open

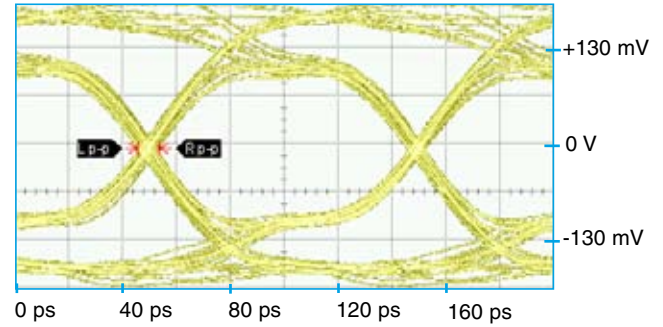

Eye Height	Eye Width	SNR	Jitter <sub>P-P</sub>
72.8 mV	88.1 ps	4.31	8.00 ps

## SERIES RF312

Normally Closed

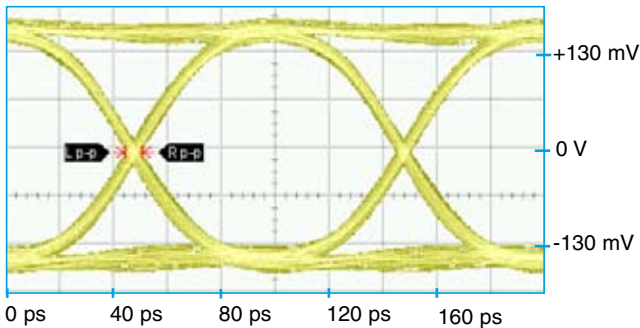

Eye Height	Eye Width	SNR	Jitter <sub>P-P</sub>
266.5 mV	89.21 ps	19.44	9.78 ps

Normally Open

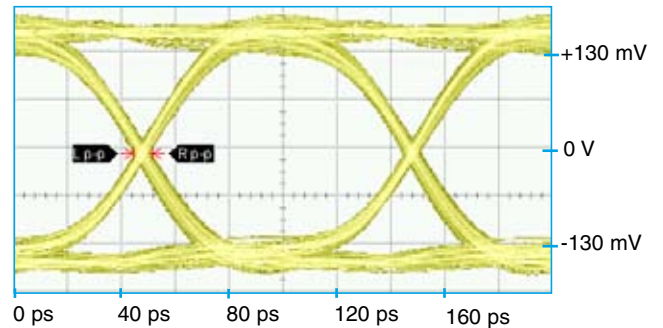

Eye Height	Eye Width	SNR	Jitter <sub>P-P</sub>
264.3 mV	89.07 ps	19.13	8.00 ps

# APPENDIX: SIGNAL INTEGRITY EYE DIAGRAMS

## SERIES GRF312

Normally Closed

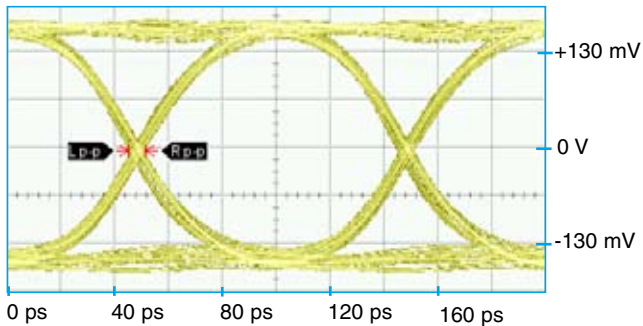

Eye Height	Eye Width	SNR	Jitter <sub>P-P</sub>
266.5 mV	91.09 ps	20.75	6.22 ps

Normally Open

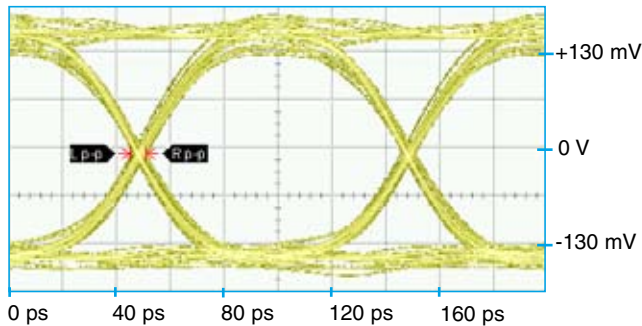

Eye Height	Eye Width	SNR	Jitter <sub>P-P</sub>
239.6 mV	92.77 ps	14.52	5.78 ps

## SERIES SGRF312

Normally Closed

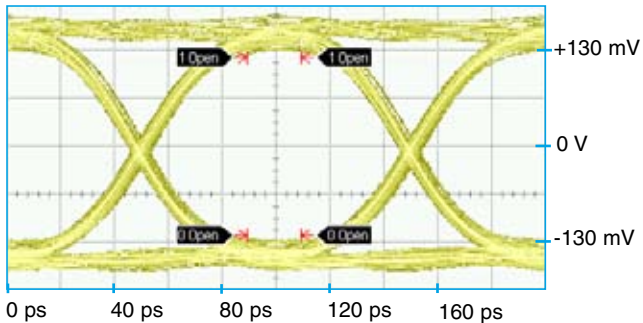

Eye Height	Eye Width	SNR	Jitter <sub>P-P</sub>
240.7 mV	91.44 ps	15.49	8.44 ps

Normally Open

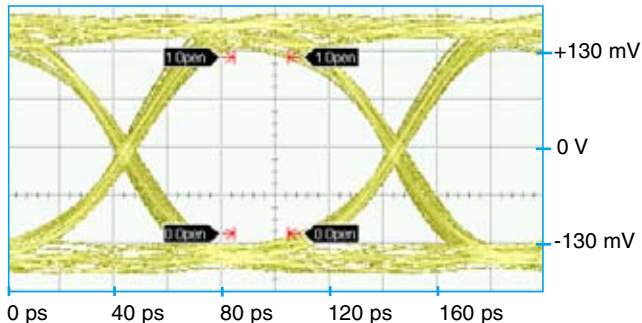

Eye Height	Eye Width	SNR	Jitter <sub>P-P</sub>
237.1 mV	89.08 ps	13.72	8.00 ps

## SERIES RF311/RF331

Normally Closed

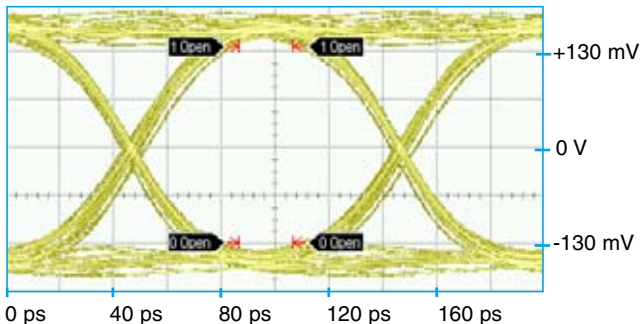

Eye Height	Eye Width	SNR	Jitter <sub>P-P</sub>
266.5 mV	89.21 ps	19.44	9.78 ps

Normally Open

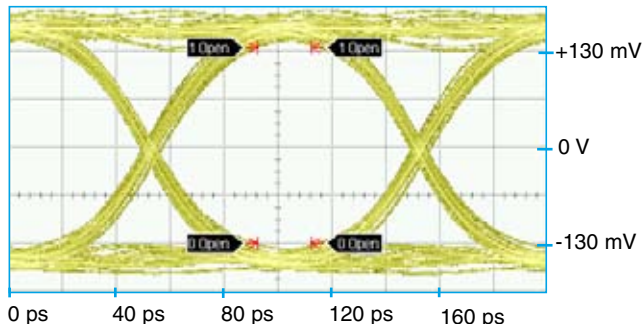

Eye Height	Eye Width	SNR	Jitter <sub>P-P</sub>
264.3 mV	89.07 ps	19.13	8.00 ps

# APPENDIX: SIGNAL INTEGRITY EYE DIAGRAMS

## SERIES GRF311

Normally Closed

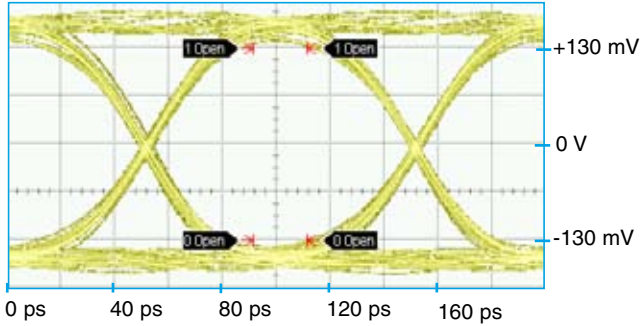

Eye Height	Eye Width	SNR	Jitter <sub>P-P</sub>
260.0 mV	92.32 ps	17.98	6.67 ps

Normally Open

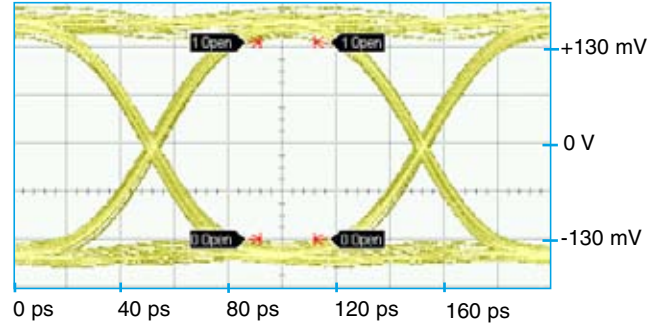

Eye Height	Eye Width	SNR	Jitter <sub>P-P</sub>
267.2 mV	90.99 ps	20.84	7.11 ps

## SERIES GRF342

Normally Closed

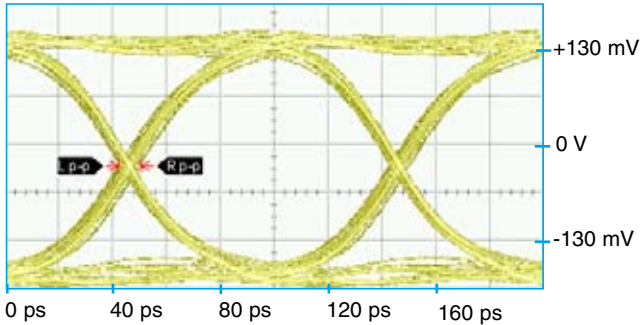

Eye Height	Eye Width	SNR	Jitter <sub>P-P</sub>
252.9 mV	90.74 ps	16.53	8.44 ps

Normally Open

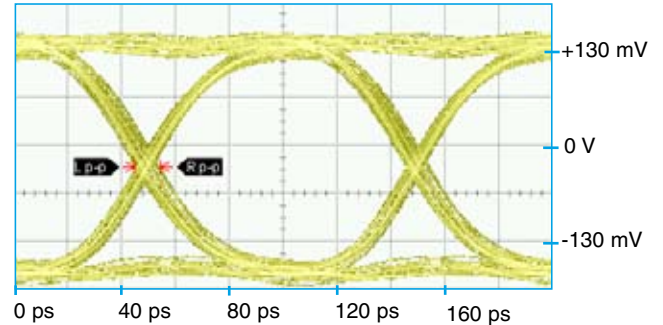

Eye Height	Eye Width	SNR	Jitter <sub>P-P</sub>
253.1 mV	87.31 ps	17.57	9.78 ps

## SERIES RF180

Normally Closed

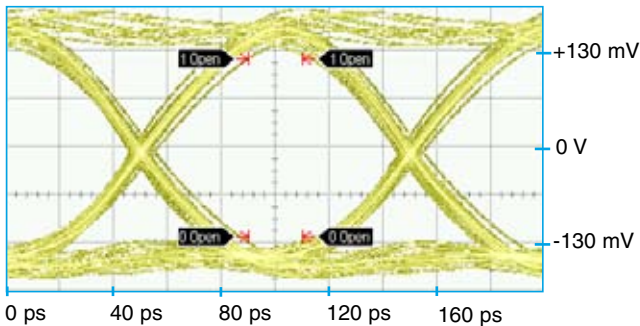

Eye Height	Eye Width	SNR	Jitter <sub>P-P</sub>
240.5 mV	88.16 ps	13.86	10.67 ps

Normally Open

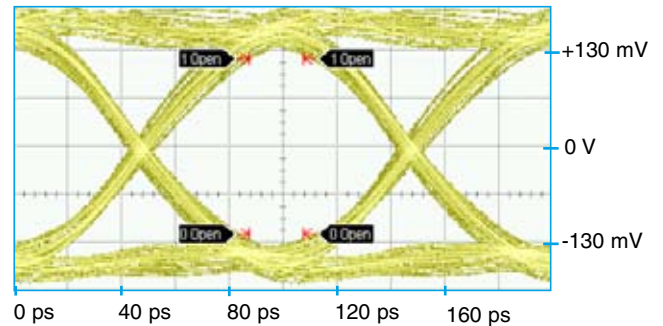

Eye Height	Eye Width	SNR	Jitter <sub>P-P</sub>
235.8 mV	87.22 ps	12.75	10.22 ps



# APPENDIX: SIGNAL INTEGRITY EYE DIAGRAMS

## SERIES RF341

Normally Closed

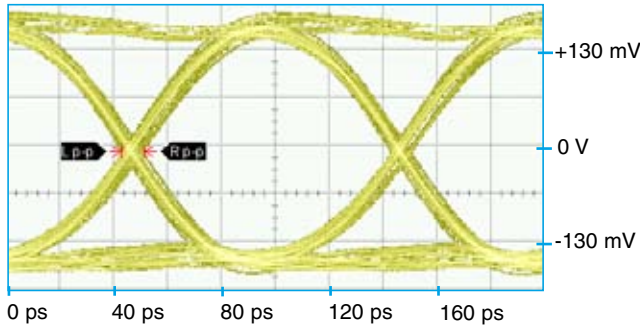

Eye Height	Eye Width	SNR	Jitter <sub>P-P</sub>
260.9 mV	88.26 ps	18.39	8.44 ps

Normally Open

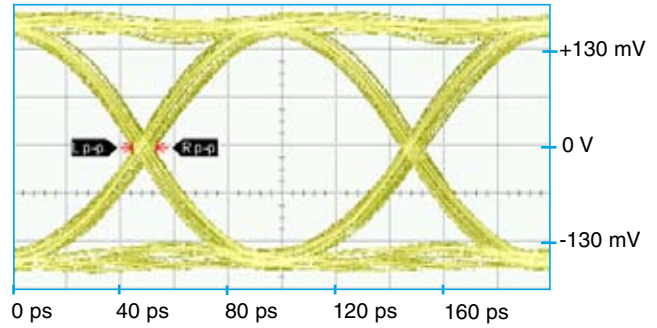

Eye Height	Eye Width	SNR	Jitter <sub>P-P</sub>
271.5 mV	86.41 ps	21.35	8.89 ps

## SERIES GRF341

Normally Closed

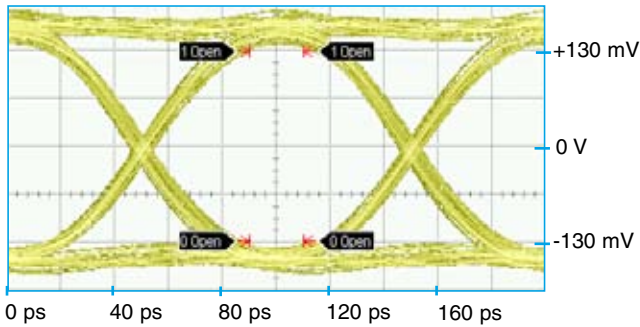

Eye Height	Eye Width	SNR	Jitter <sub>P-P</sub>
256.2 mV	87.70 ps	17.15	8.89 ps

Normally Open

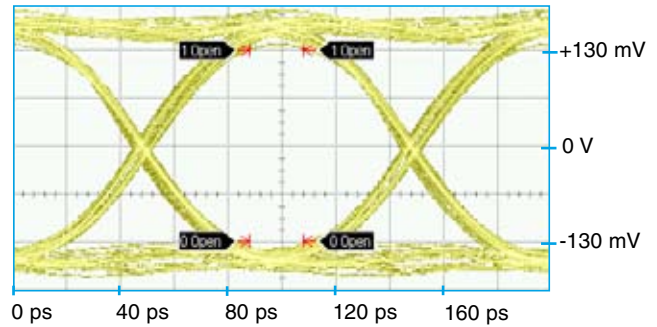

Eye Height	Eye Width	SNR	Jitter <sub>P-P</sub>
259.9 mV	88.39 ps	17.59	8.00 ps

## SERIES RF310/RF313

Normally Closed

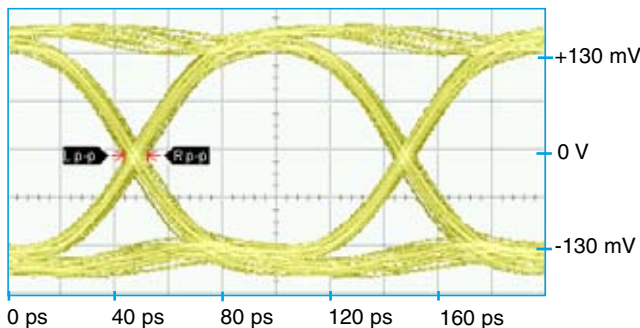

Eye Height	Eye Width	SNR	Jitter <sub>P-P</sub>
246.1 mV	92.45 ps	14.59	6.22 ps

Normally Open

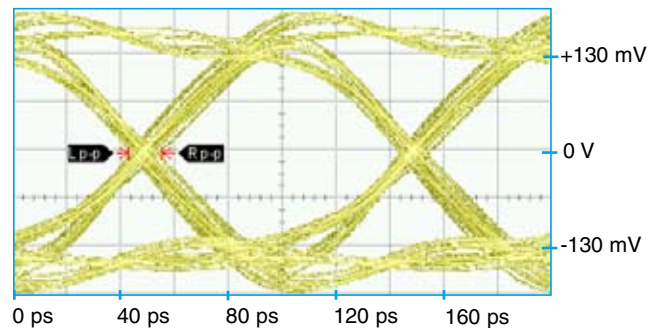

Eye Height	Eye Width	SNR	Jitter <sub>P-P</sub>
268.2 mV	90.87 ps	21.62	7.56 ps

# APPENDIX: SIGNAL INTEGRITY EYE DIAGRAMS

## SERIES RF320/RF323

Normally Closed

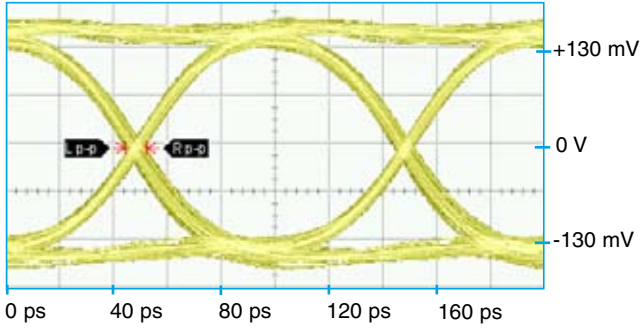

Eye Height	Eye Width	SNR	Jitter <sub>P-P</sub>
246.1 mV	92.45 ps	14.59	6.22 ps

Normally Open

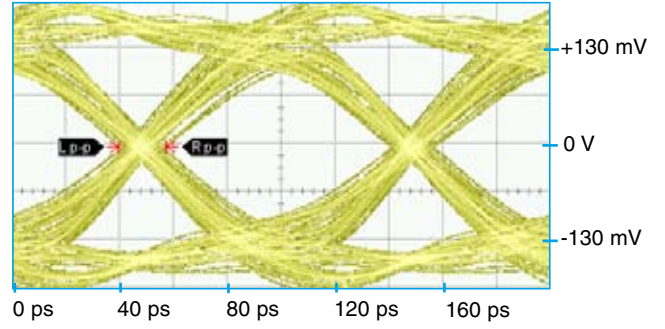

Eye Height	Eye Width	SNR	Jitter <sub>P-P</sub>
268.2 mV	90.87 ps	21.62	7.56 ps

## SERIES A150

Attenuated Path

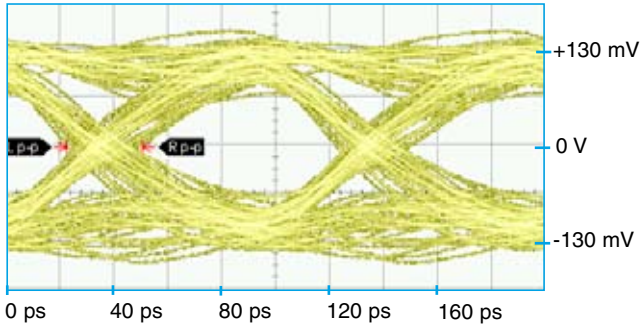

Eye Height	Eye Width	SNR	Jitter <sub>P-P</sub>
45.59 mV	64.18 ps	5.70	28.00 ps

Thru Path

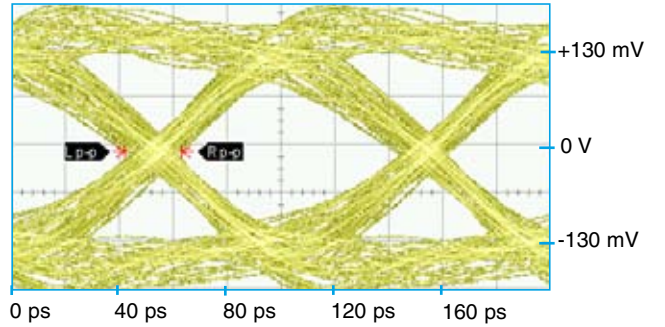

Eye Height	Eye Width	SNR	Jitter <sub>P-P</sub>
130.2 mV	72.87 ps	5.29	20.89 ps

## SERIES GA150

Attenuated Path

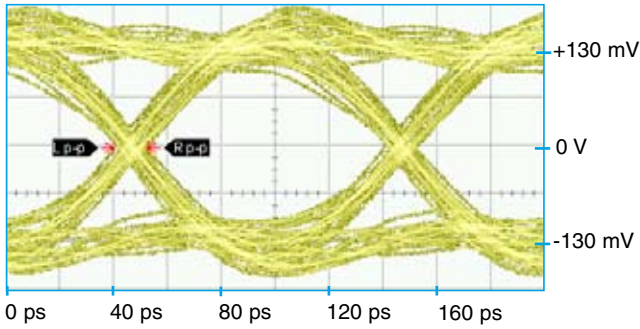

Eye Height	Eye Width	SNR	Jitter <sub>P-P</sub>
62.10 mV	83.23 ps	7.14	12.89 ps

Thru Path

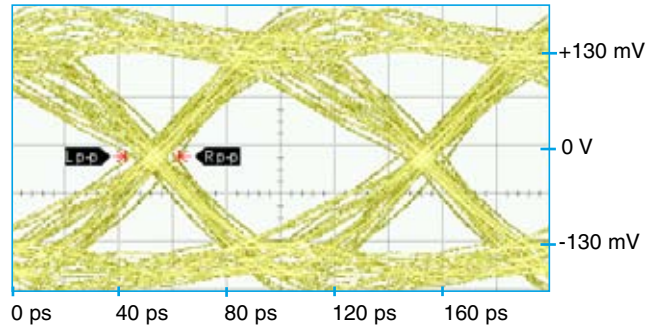

Eye Height	Eye Width	SNR	Jitter <sub>P-P</sub>
130.3 mV	78.38 ps	5.30	19.56 ps

# APPENDIX: SIGNAL INTEGRITY EYE DIAGRAMS

## SERIES A152

Attenuated Path

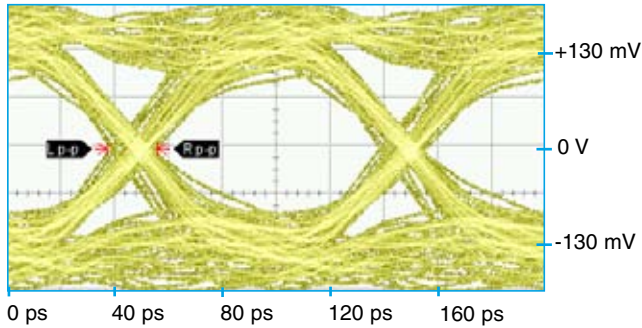

Eye Height	Eye Width	SNR	Jitter <sub>P-P</sub>
45.10 mV	78.94 ps	5.57	18.67 ps

Thru Path

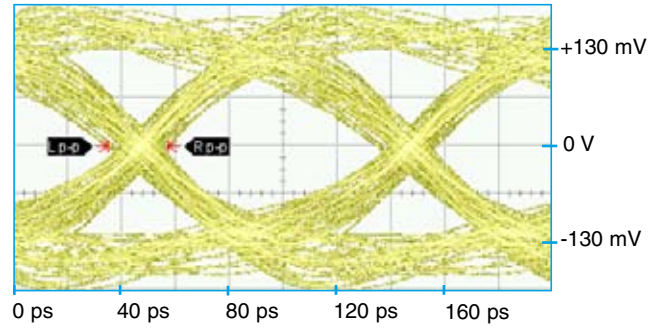

Eye Height	Eye Width	SNR	Jitter <sub>P-P</sub>
124.5 mV	73.90 ps	5.23	22.22 ps

## SERIES GA152

Attenuated Path

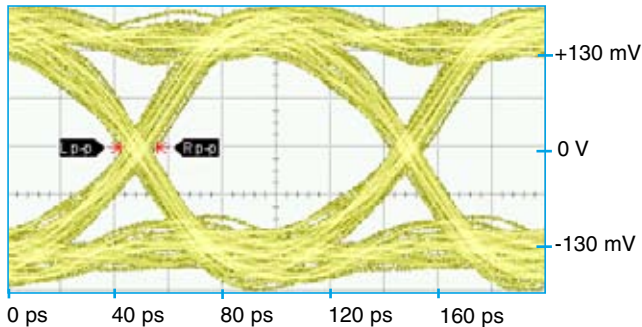

Eye Height	Eye Width	SNR	Jitter <sub>P-P</sub>
67.99 mV	82.70 ps	7.85	13.78 ps

Thru Path

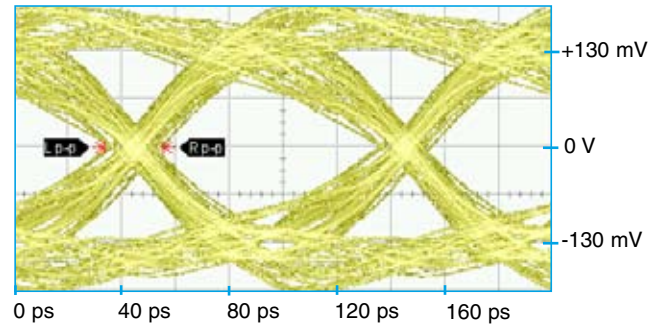

Eye Height	Eye Width	SNR	Jitter <sub>P-P</sub>
122.9 mV	76.21 ps	5.07	21.78 ps

## PATTERN GENERATOR SETTINGS

- 10 Gbps Random Pulse Pattern Generator
- $2^{31} - 1$  PRBS signal
- PRBS output of 300mV<sub>P-P</sub> (nominal)
- RF PCB effect (negligible) not removed from measurement
- Data shown is typical of both poles



# RoHS and REACH CERTIFICATE OF COMPLIANCE

## RoHS

It is hereby stated and certified that Teledyne Relays complies with the Restrictions on Hazardous Substances (RoHS) Directives to the extent herein:

Teledyne Relays does not use any of the Restricted Substances specified by the RoHS Directives (listed below) as components in TO-5 and Centigrad® Electromechanical Relay products, nor are these substances employed during any electromechanical relay manufacturing process:

*Lead*  
*Mercury*  
*Cadmium*  
*Hexavalent Chromium*  
*Polybrominated Biphenyls (PBB's)*  
*Polybrominated Diphenyl Ethers (PBDE's)*

However, upon request from the Customer, relay leads may be coated with solder, which contains 60% tin and 40% lead.

## REACH

It is hereby stated and certified that Teledyne Relays complies with the Registration Evaluation Authorization and Restriction of Chemicals (REACH) Directives to the extent stated herein:

Teledyne Relays is a manufacturer of articles. Teledyne Relays has taken the initiative to review the (39) substances that are under consideration for treatment as Substances of Very High Concern (SVHC) candidates. Teledyne Relays confirmed that our relays do not contain any of the listed substances in concentration >0.1% weight per supplied article, substance or preparation weight.



RoHS or Non-RoHS:  
Your Choice!



**TELEDYNE  
RELAYS**

A Teledyne Technologies Company

For Additional Information please E-Mail us at: [relays@teledyne.com](mailto:relays@teledyne.com)

# APPENDIX: TELEDYNE RELAYS PART NUMBERING SYSTEM

## RF Attenuator Relays

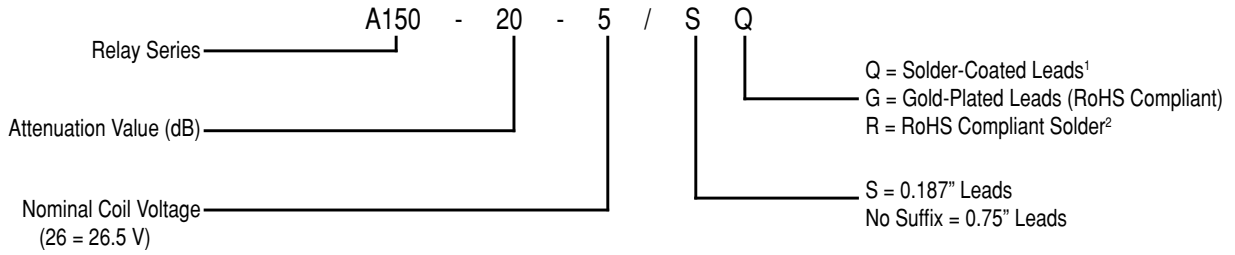

## RF Relays (Except Attenuator Relays)

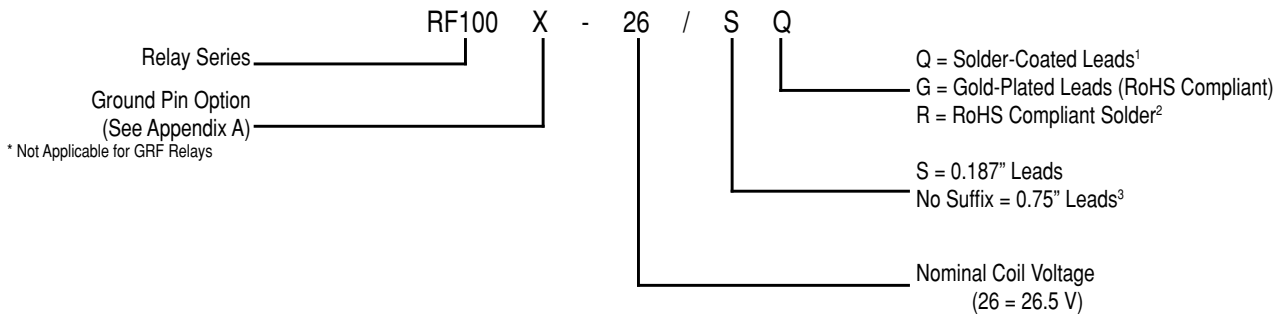

## T<sup>2</sup>R Established Reliability Relays

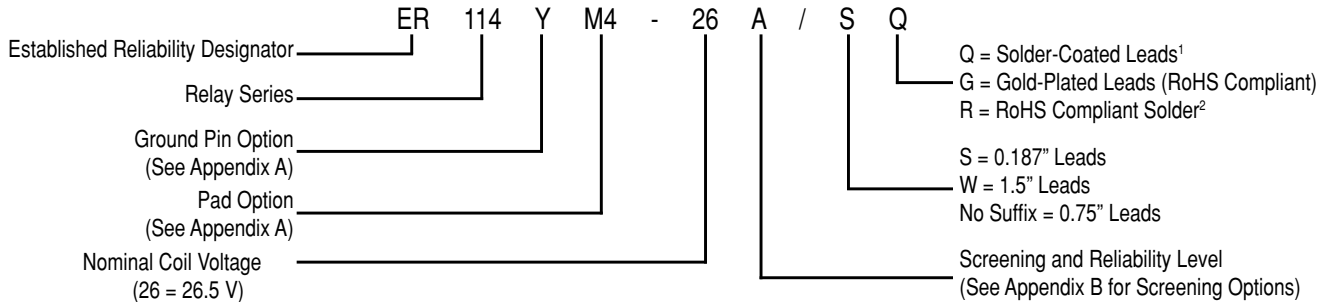

## Military Qualified (JAN) Relays

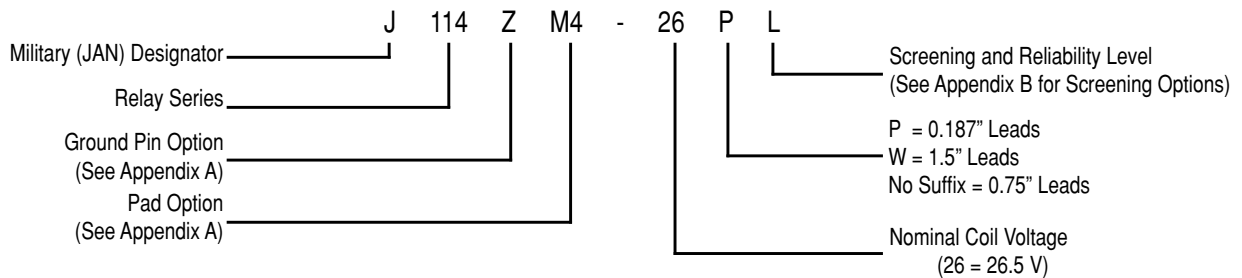

General Note: Parts ordered without suffix may be supplied with Solder-Coated or Gold-Plated leads

<sup>1</sup> Parts ordered with Solder-Coated leads will have (Sn60/Pb40)

<sup>2</sup> Parts ordered with RoHS Solder-Coated leads will have (Sn99.3/Cu0.7)

<sup>3</sup> Not Applicable to GRF relays

# APPENDIX: TELEDYNE RELAYS PART NUMBERING SYSTEM

## Commercial Surface Mount Relays

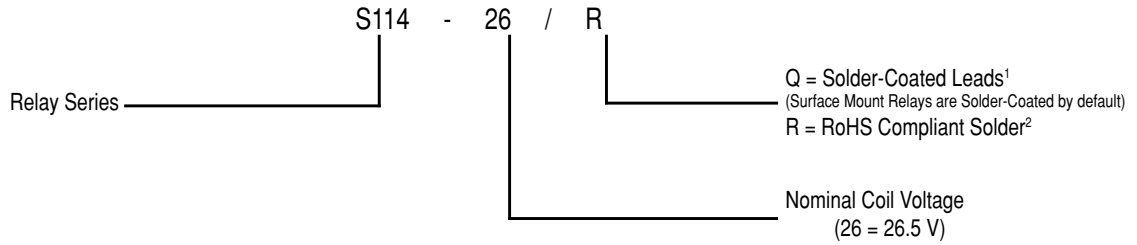

## Commercial Relays, (Except Surface Mount Relays)

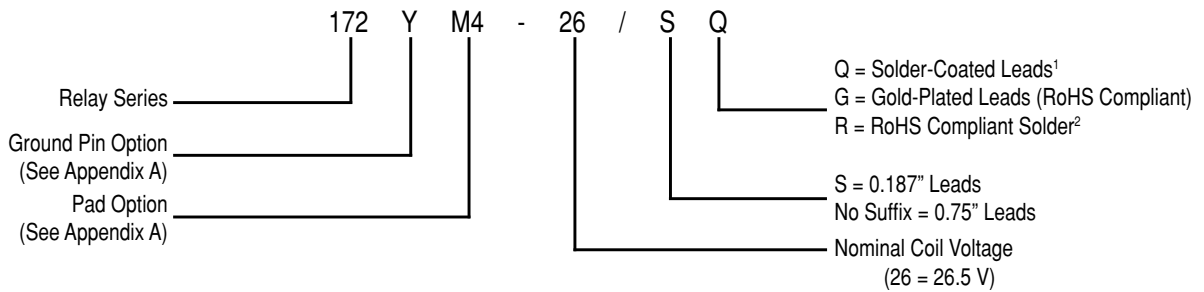

## High Performance Relays

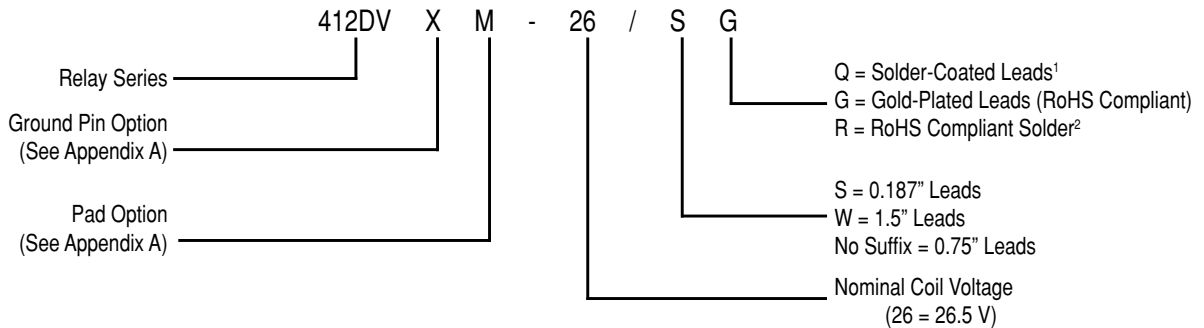

General Note: Parts ordered without suffix may be supplied with Solder-Coated or Gold-Plated leads.

<sup>1</sup> Parts ordered with Solder-Coated leads will have (Sn60/Pb40)

<sup>2</sup> Parts ordered with RoHS Solder-Coated leads will have (Sn99.3/Cu0.7)

**If you don't see what you're looking for  
in this Selection Guide, contact us!**

## APPENDIX: Spacer Pads

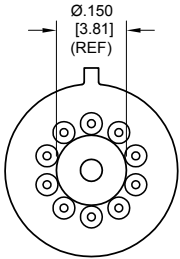
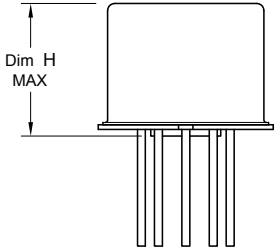
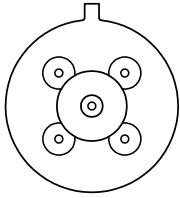
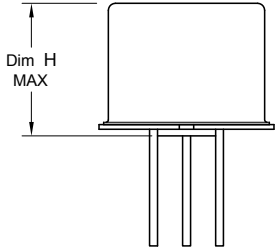
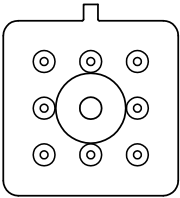
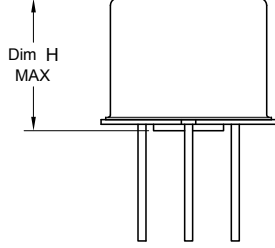
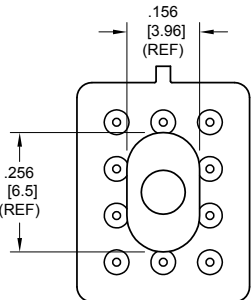
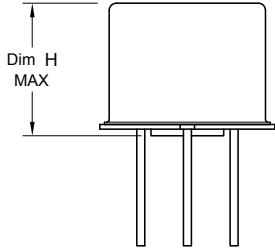
Pad designation and bottom view dimensions	Height	For use with the following:	Dim. H Max.
 <p style="text-align: center;">“M4” Pad for TO-5</p>		ER412, ER412D, ER412DD	.295 (7.49)
		712, 712D, 712TN, RF300, RF310, RF320	.300 (7.62)
		ER420, ER422D, ER420DD, 421, ER421D, ER421DD, ER422, ER422D, ER422DD, 722, 722D, RF341	.305 (7.75)
		ER431T, ER432T, ER432, ER432D, ER432DD	.400 (10.16)
		732, 732D, 732TN, RF303, RF313, RF323 RF312	.410 (10.41) .350 (8.89)
 <p style="text-align: center;">“M4” Pad for TO-5</p>		ER411, ER411D, ER411DD, ER411T	.295 (7.49)
		ER431, ER431D, ER431DD	.400 (10.16)
		RF311	.300 (7.62)
		RF331	.410 (10.41)
 <p style="text-align: center;">“M4” Pad for Centigrad®</p>		172, 172D	.305 (7.75)
		ER114, ER114D, ER114DD, J114, J114D, J114DD	.300 (7.62)
		ER134, ER134D, ER134DD, J134, J134D, J134DD	.400 (10.16)
		RF100	.315 (8.00)
		RF103	.420 (10.67)
 <p style="text-align: center;">“M9” Pad for Centigrad®</p>		122C, A152	.320 (8.13)
		ER116C, J116C	.300 (7.62)
		ER136C, J136C	.400 (10.16)
		RF180	.325 (8.25)
		A150	.305 (7.75)

**Notes:**

1. Spacer pad material: Polyester film.
2. To specify an “M4” or “M9” spacer pad, refer to the mounting variants portion of the part numbering example in the applicable datasheet.
3. Dimensions are in inches (mm).
4. Unless otherwise specified, tolerance is  $\pm .010$ " (.25 mm).
5. Add 10 m $\Omega$  to the contact resistance shown in the datasheet.
6. Add 0.01 oz. (0.25 g) to the weight of the relay assembly shown in the datasheet.

## APPENDIX: Spreader Pads

Pad designation and bottom view dimensions	Height	For use with the following:	Dim. H Max.
<p style="text-align: center;"><b>"M" Pad <u>5/ 6/</u></b></p>		ER411T, J411T, ER412, ER412D ER412DD, J412, J412D, J412DD ER412T, J412T	.388 (9.86)
		712, 712D, 712TN	.393 (9.99)
		ER431T, J431T, ER432, ER432D ER432DD, J432, J432D, J432DD ER432T, J432T	.493 (12.52)
		732, 732D, 732TN	.503 (12.78)
		ER420, J420, ER420D, J420D ER420DD, J420DD, ER421, J421 ER421D, J421D, ER421DD J422D, ER422DD, J422DD, 722	.398 (10.11)
<p style="text-align: center;"><b>"M2" Pad <u>7/ 8/</u></b></p>		ER411T ER412, ER412D, ER412DD J412, J412D, J412DD	.441 (11.20)
		712, 712D	.451 (11.46)
		ER421, ER421D, ER421DD 722, 732D	.451 (11.46)
		ER431T ER432, ER432D, ER432DD	.546 (13.87)
		732, 732D	.556 (14.12)
<p style="text-align: center;"><b>"M3" Pad <u>5/ 6/ 9/</u></b></p>		ER411, ER411D, ER411DD, ER411TX ER412X, ER412DX, ER412DDX ER412TX	.388 (9.86)
		712X, 712DX, 712TNX	.393 (9.99)
		ER420X, ER420DX, ER420DDX ER421X, ER421DX, ER421DDX ER422X, ER422DX ER422DDX, 722X, 722DDX	.398 (10.11)
		ER431, ER431D, ER431DD ER431TX ER432X, ER432DX, ER432DDX ER432TX	.493 (12.52)
		732X, 732DX, 732TNX	.503 (12.78)

**Notes:**

1. Spreader pad material: Diallyl Phthalate.
2. To specify an "M", "M2" or "M3" spreader pad, refer to the mounting variants portion of the part number example in the applicable datasheet.
3. Dimensions are in inches (mm).
4. Unless otherwise specified, tolerance is  $\pm .010$ " (0.25 mm).
- 5/. Add 25 m $\Omega$  to the contact resistance shown in the datasheet.
- 6/. Add .01 oz. (0.25 g) to the weight of the relay assembly shown in the datasheet.
- 7/. Add 50 m $\Omega$  to the contact resistance shown in the datasheet.
- 8/. Add 0.025 oz (0.71 g) to the weight of the relay assembly shown in the datasheet.
- 9/. M3 pad to be used only when the relay has a center pin (e.g. ER411M3-12A, 722XM3-26.)



## APPENDIX: Ground Pin Positions

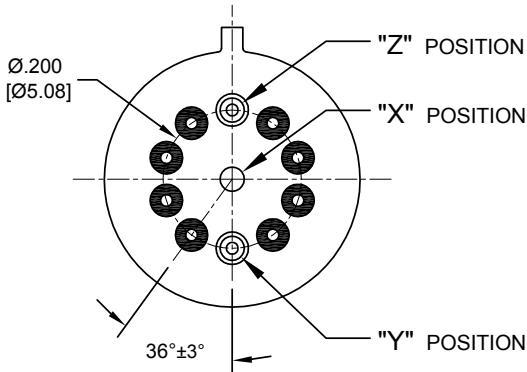

### TO-5 Relays:

ER411T, ER412, ER412T, ER420, ER421, ER422, ER431T, ER432, ER432T, 712, 712TN, 400H, 400K, 400V, RF300, RF303, RF341, RF312, RF310, RF313, RF320, RF323

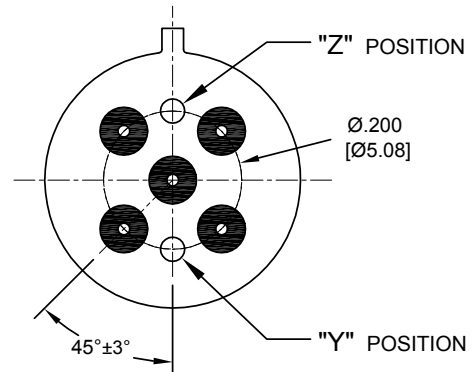

### TO-5 Relays:

ER411, ER431, RF311, RF331

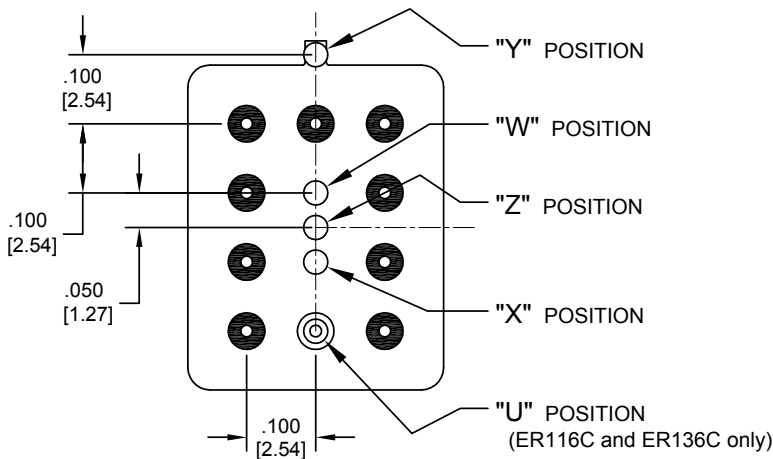

### Centigrad® Relays:

RF180, ER116C, 122C, ER136C

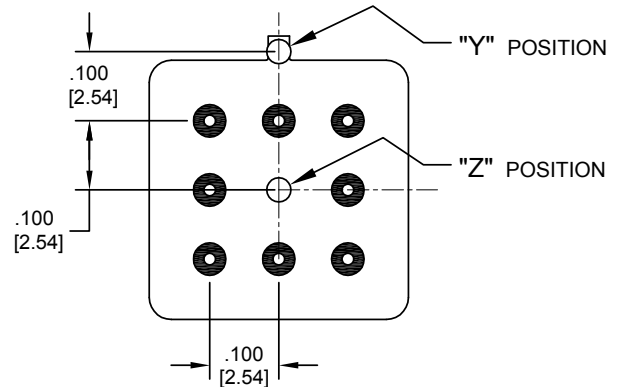

### Centigrad® Relays:

RF100, RF103, ER114, ER134, 172

- Indicates ground pin position
- Indicates glass insulated lead position
- ⊙ Indicates ground pin or lead position depending on relay type

### NOTES

1. Terminal views shown
2. Dimensions are in inches (mm)
3. Tolerances:  $\pm .010$  ( $\pm .25$ ) unless otherwise specified
4. Ground pin positions are within  $.015$  ( $0.38$ ) dia. of true position
5. Ground pin head dia.,  $0.035$  ( $0.89$ ) ref: height  $0.010$  ( $0.25$ ) ref.
6. Lead dia.  $0.017$  ( $0.43$ ) nom.

## APPENDIX: Teledyne Relays T<sup>2</sup>R Program

Teledyne Relays' **T<sup>2</sup>R** program was developed to provide the JAN relay user an alternate means of specifying and procuring established reliability relays. The form, fit and function of a **T<sup>2</sup>R** relay is the same as that of its JAN counterpart. **T<sup>2</sup>R** program requirements differ in certain regimens/tests found in both MIL-PRF-28776 and MIL-PRF-39016 that add cost but no value to the relay.

This program parallels the military specifications in most aspects. The components that make up such a program are intricate and varied. Furthermore, there are additional options of high value for design, manufacturability and operation of high reliability assemblies. The following page presents a table that compares the 100% screening performed on JAN relays and **T<sup>2</sup>R** relays prior to shipment.

Other significant highlights of the **T<sup>2</sup>R** program include:

- Two unique screening levels
- The ability to define lead finish
- Spacer pad options which may not be available in military specifications
- Ground pin options which may not be available in military specifications
- Reduced lead time
- Reduced cost

The program is fully defined for both general product requirements and detailed product requirements in the following Teledyne Relays specifications:

TR-R-1  
TR-STD-1  
TR-STD-2  
TR-ERL-1  
TR-R-1/XXX  
TR Supplement

Copies of these documents are available from Teledyne Relays. We suggest that users check with Teledyne Relays from time to time to assure that they have the latest issue.

## Can't Find What You Need?

Check out our full line of relays and switches. Order literature online at <http://www.teledynereleys.com/lit-request.asp>



## APPENDIX: Teledyne Relays T<sup>2</sup>R Program

INSPECTION	Screening Levels			
	<i><b>TR</b></i> A Level 1.5%/10K Cycles	<i><b>TR</b></i> B Level .75%/10K Cycles	JAN L Level 3%/10K Cycles	JAN M Level 1%/10K Cycles
<b>Subgroup 1</b>				
Screening, Internal Moisture AQL <sup>1</sup>	✓	✓	✓	✓
Vibration (Sinusoidal) AQL <sup>1</sup>			✓	
Vibration (Sinusoidal) 100%		✓		✓
Screening, Burn-In (Hybrids only)			✓	✓
Screening, Run-In (Room Temperature)	✓			
Screening, Run-In (+125°C and -65°C)		✓	✓	✓
<b>Subgroup 2</b>				
Coil Resistance or Coil Current	✓	✓	✓	✓
Insulation Resistance	✓	✓	✓	✓
Dielectric Withstanding Voltage	✓	✓	✓	✓
Static Contact Resistance	✓	✓	✓	✓
Pickup and Dropout or Set and Reset Voltage	✓	✓	✓	✓
Operate and Release or Set and Reset Time	✓	✓	✓	✓
Hold Voltage			✓	✓
Turn-On and Turn-Off Time (Hybrids only)	✓	✓	✓	✓
Contact Bounce Time	✓		✓	
Contact Stabilization Time		✓		✓
Turn-On Current (T Hybrids only)	✓	✓	✓	✓
Turn-On Voltage (C Hybrids only)	✓	✓	✓	✓
Turn-Off Voltage (Hybrids only)	✓	✓	✓	✓
Coil Transient Suppression (D, DD and Hybrids only)	✓	✓	✓	✓
Diode Blocking Integrity (DD only)	✓	✓	✓	✓
Zener Voltage (C Hybrid only)	✓	✓	✓	✓
Neutral Screen (Latching Relays only)	✓	✓	✓	✓
Break Before Make Verification			✓	✓
Contact Simultaneity			✓	✓
<b>Subgroup 3</b>				
Solderability 2 Samples per Daily Solderability Inspection Lot	✓	✓	✓	✓
Leak Test	✓	✓	✓	✓
External Visual and Mechanical Inspection 2/Lot for Dimension and Weight Check	✓	✓	✓	✓

<sup>1</sup> AQL = Acceptable Quality Level

## Teledyne Relays: Because in deep space there is no acceptable failure rate

Teledyne Relays has a long history of supplying High Reliability relays for use in space bound vehicles. From the earliest deep space probes, such as Voyager I, now nearing 21 billion miles out in space, to the next generation of probes scheduled for the future, Teledyne Relays continues to be the preeminent supplier of Hi-Reliability relays to the space market.

### Teledyne Relays Hi-Reliability Specification:

#### TR-HIREL-1

- Eliminates the need for customers to develop and maintain specifications.
- Manufacturing and Quality Assurance requirements are fully defined and documented.
- Meets the general requirements of both ESA/SCC and NASA/GSFC documents.
- Offers options for 100% Group A screening
- Offers options for 3 levels of Lot Acceptance Testing (LAT).

### Teledyne Screening Document 0-40-837

NASA approved screening regimen based on NASA/GSFC S-311-P.754

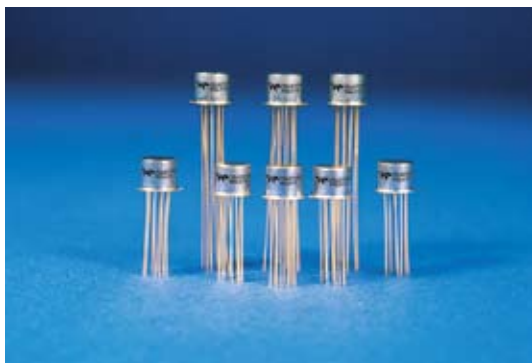

### RELAY TYPES

- TO-5 Magnetic-Latching Relays
- TO-5 Non-Latching Relays
- TO-5 Magnetic-Latching, High-Shock Relays
- TO-5 Non-Latching, High-Shock Relays
- TO-5 Non-Latching, High-Vibration Relays

### HI-REL SCREENING CAPABILITIES

- 100% Open Electrical Inspection
- 100% Precap Inspection
- Fully Automated Small Particle Inspection (Millipore Clean)
- Asynchronous Miss Test
- Coil Continuity
- Sine Vibration
- Random Vibration
- High/Low Run In
- (Miss Test)  $-65^{\circ}\text{C} \pm 125^{\circ}\text{C}$
- Radiographic Inspection
- Mechanical Shock Test
- Thermal Shock Test
- Acceleration
- Radiographic Inspection (X-ray)
- Mechanical Shock Test
- Thermal Shock Test
- Acceleration
- Load Banks for a Variety of Life Test Load
- Serialized Printed Electrical Data
- Continuous Life Testing
- Environmental Testing
- Vertical Integration

For information or answers to your questions, please visit our website.

## APPENDIX: Authorized Distributors

### NORTH AMERICA

**ALLIED ELECTRONICS**  
Tel: (800) 433-5700  
www.alliedelec.com/search.asp

**ASAP ELECTRONICS**  
Tel: (800) 477-1272  
www.asapelectronics.com

**AVNET**  
Tel: (800) 772-8638  
www.em.avnet.com

**MASTER DISTRIBUTORS**  
Tel: (888) 473-5297  
www.onlinecomponents.com

**MOUSER ELECTRONICS**  
Tel: (800) 346-6873  
www.mouser.com

**RICHARDSON ELECTRONICS**  
Tel: (800) 737-6937  
www.rell.com

**SHERBURN ELECTRONICS**  
Tel: (800) 366-3066  
www.sherburn.com

**BELGIUM & LUXEMBOURG**  
**Nijkerk Electronics B.V.**  
Tel: +32 (0) 3 544 7066  
E-mail: alain.huysmans@nijkerk.be  
www.nijkerk-ne.com

**CHINA & HONG KONG**  
**Fiaco Microelectronics**  
Beijing Office  
Tel: 86-10-6503-2171  
E-mail: beijing@fiaco.com

**Bright Toward Industrial Co., Ltd.**  
Beijing Office  
Tel: 86-10-8200-4979  
E-mail: linden\_wang@toward.com.cn

**CZECH REPUBLIC**  
**Amtek spol. s.r.o.**  
Tel: +420 547 125 555  
E-mail: amtek@amtek.cz  
www.amtek.cz

**DENMARK**  
**ARROW Denmark A/S**  
Tel: +45 (0) 70102211  
E-mail: jbh@arrownordic.com  
www.arrowne.com

**ESTONIA**  
**ARROW Estonia**  
Tel: +372 6 774250  
E-mail: estonia@arrownordic.com  
www.arrowne.com

**FINLAND**  
**ARROW Finland Oy**  
Tel: +358 9 3212 831  
www.arrowne.com

**FRANCE**  
**ARROW France**  
Tel: +33 1 4978 4960  
E-mail: ralves@arrowfrance.com

**GERMANY**  
**Adelco Elektronik GmbH**  
Tel: +49 (0) 4106 61040  
E-mail: adelco@t-online.de  
www.adelco-elektronik.de

**Hot Electronic GmbH**  
Tel: +49 (0) 89 666 2836  
E-mail: info@hot-electronic.de  
www.hot-electronic.de

**MRC Components oHG**  
Tel: +49 (0) 8161 98480  
E-mail: info@mrccomponents.de  
www.mrccomponents.de

**Zettler electronics GmbH**  
Tel: +49 (0) 89 800 97-0  
E-mail: office@zettlerelectronics.com  
www.zettlerelectronics.com

**INDIA**  
**Specsynergy Technologies, Inc.**  
San Jose, CA (Main Office)  
Tel: (408) 954-8474 x105  
E-mail: karthik@spectraus.com

**Specsynergy Technologies, Inc.**  
New Delhi Office  
Tel: 91 11 25860 752  
E-mail: malik@specsynergytech.com

**ISRAEL**  
**STG International Ltd.**  
Tel: +972 (0) 3 733 1400  
E-mail: davidb@stggroup.co.il  
www.stggroup.co.il

**ITALY**  
**SINCRON s.r.l.**  
Tel: +39 02 95384218  
E-mail: ermanno.baschieri@sincron.it  
www.sincron.it

**JAPAN**  
**Comcraft Corporation Tokyo**  
Tel: 81-3-3395-5553  
E-mail: trcsales@comcraft.co.jp  
www.comcraft.co.jp

**Comcraft Corporation Osaka**  
Tel: 81-6-6396-7722  
E-mail: trcsales@comcraft.co.jp  
www.comcraft.co.jp

**KOREA**  
**Electro-Comm USA**  
Tel: (818) 848-7790  
E-mail: briansong@anyeparts.com  
www.anyeparts.com

**Electro-Comm SEOUL**  
Tel: 82-31-713-4216  
E-mail: tony\_jang@anyeparts.com  
www.anyeparts.com

**LATVIA**  
**ARROW Latvia**  
Tel: +371 7311490  
E-mail: latvia@arrownordic.com  
www.arrowne.com

**LITHUANIA**  
**ARROW Lithuania**  
Tel: +370-37-759015  
E-mail: lithuania@arrownordic.com  
www.arrowne.com

**MALAYSIA**  
**Device Electronics PTE, Ltd.**  
Tel: (603) 7880 8626/8636  
E-mail: ngthomas@devicelect.com

**NETHERLANDS**  
**Nijkerk Electronics B.V.**  
Tel: +32 (0) 3 544 7066  
E-mail: alain.huysmans@nijkerk.be  
www.nijkerk-ne.com

**NORWAY**  
**ARROW Norway A/S**  
Tel: +47 (0) 21306532  
E-mail: stondevoldshagen@arrownordic.com  
www.arrowne.com

**RUSSIA**  
**Petersburg Electronic Company JSC**  
Tel: +7 812 4488 777  
E-mail: dkizha@pec.spb.ru  
www.pec.spb.ru

**SINGAPORE**  
**Device Electronics PTE, Ltd.**  
Tel: 65-288 6455  
E-mail: ngthomas@devicelect.com

**SOUTH AFRICA**  
**RF Design**  
Tel:  
National Smart Call: 0861 753 357  
Cape Town: +27 (0) 21 555 8400  
Gauteng: +27 (0) 11 695 2200  
Durban: +27 (0) 31 266 4534  
www.rfdesign.co.za

**SWEDEN**  
**ARROW Sweden**  
Tel: +46 8 56265500  
E-mail: aekstrom-winroth@arrownordic.com  
www.arrowne.com

**MicroComp Nordic AB**  
Tel: +46 8 607 3910  
E-mail: info@microcomp-nordic.se  
www.mcnaab.se

**OEM Electronics**  
Tel: +46 75 242 4562  
E-mail: ulf.nygren@oemelectronics.se  
www.oemelectronics.se

**SWITZERLAND**  
**ENA AG**  
Tel: +41 56 6342834  
E-mail: rolf.hochstrasser@ena.ch  
www.ena.ch

**TAIWAN**  
**Bright Toward Industrial Co., Ltd.**  
Tel: +886-2-822-76000  
E-mail: philip@relays.com.tw  
www.relays.com.tw

**UNITED KINGDOM**  
**Advanced Power Components plc**  
Tel: +44 (0) 1480 226603  
E-mail: angiep@apc-plc.co.uk  
www.apc-plc.co.uk

**Arrow Electronics UK Ltd.**  
Tel: +44 (0) 1279 626 777  
www.arrowne.com

**Willow Technologies Ltd.**  
Tel: +44 (0) 1342 835 234  
E-mail: sales@willow.co.uk  
www.willow.co.uk

**2001 Electronic Components Ltd.**  
Tel: +44 (0) 1438 742 001  
E-mail: sales@2001elec.co.uk  
www.2001elec.co.uk



## APPENDIX: Authorized North American Representatives

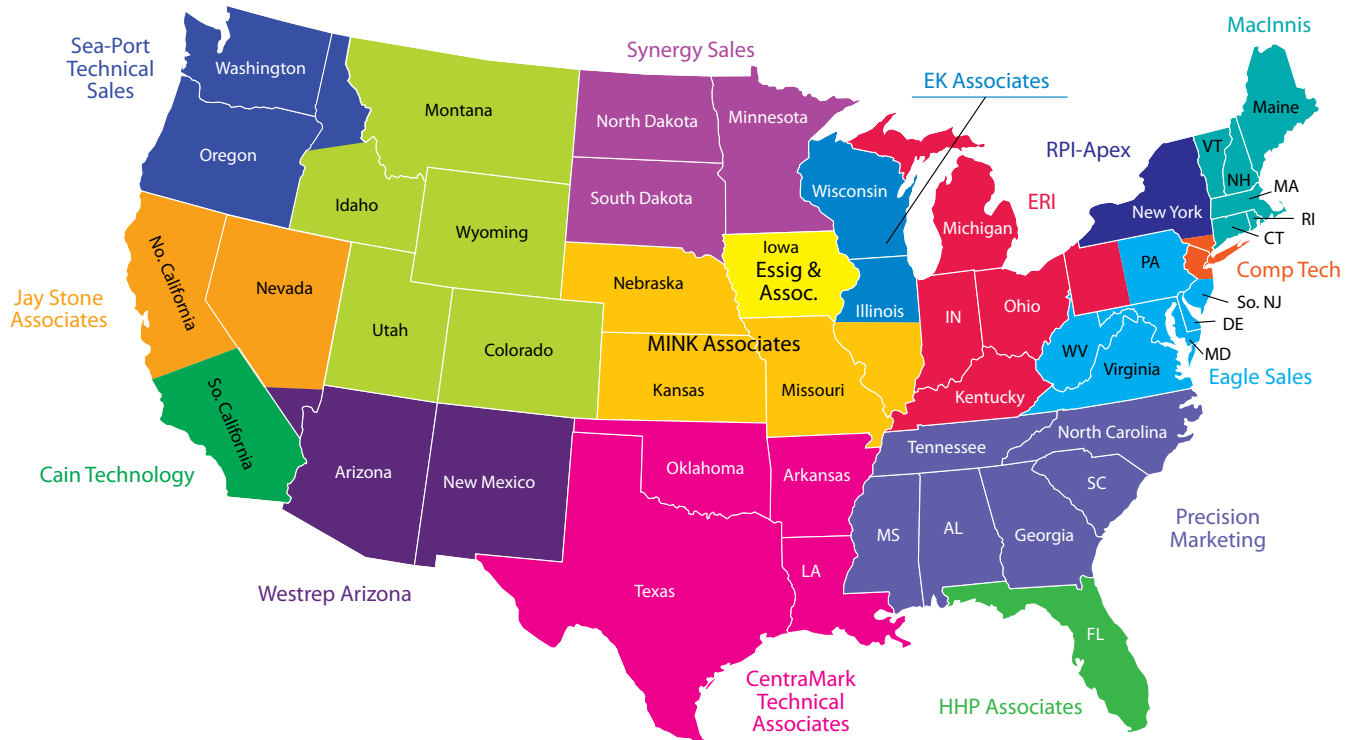

### REPRESENTATIVES

#### Cain Technology

*Southern California*  
2629 Townsgate Road, Suite 200  
Westlake Village, CA 91361  
Tel: 805-496-5702  
Fax: 805-496-6702  
www.caintech.com

#### Cee-Jay Micro Ltd.

*Eastern Canada*  
155 Terence Matthews Crescent  
Unit 2  
Kanata, Ontario  
Canada K2M 2A8  
Tel: 613-599-5626  
www.cjmicro.com

#### CentraMark Technical Sales Associates

*TX, OK and LA*  
3333 Naaman School Road  
Garland, TX 75040  
Tel: 972-414-8188  
Fax: 972-414-6788  
www.cmatex.com

#### Comp-Tech Sales

*Northern New Jersey, Metro New York, Long Island*  
232 Boulevard, Suite 11  
Hasbrouck Heights, NJ 07604  
Tel: (201) 288-7400  
Fax: (201) 288-7583  
www.comp-techsales.com

#### Eagle Sales Corporation

*MD, VA, WA DC, Eastern PA, Southern NJ*  
3545 Ellicott Mills Drive, Suite 202  
Ellicott City, MD 21043  
Tel: (410) 203-2317  
Fax: (410) 203-2318  
www.eaglesales.net

#### EK & Associates, Inc.

*IL, WI*  
887 E. Wilmette Road, Suite J  
Paltine, IL 60074  
Tel: 847-776-1758  
Fax: 847-776-8221  
www.ekrep.com

#### Electronic Representatives, Inc.

*IN, OH, MI, KY, West PA*  
6801 Lake Plaza Drive, Suite D402  
Indianapolis, IN 46220  
Tel: (317) 915-1414  
Fax: (317) 915-1216  
www.electronicreps.com

#### Essig & Associates, Inc.

*Iowa*  
809 N. Compton Drive  
Hiawatha, IA 52233  
Tel: (319) 363-8703  
Fax: (319) 363-7224  
www.essigassoc.com

#### HHP Associates, Inc.

*Florida*  
1355 S. International Pkwy, Suite 2471  
Lake Mary, FL 32746  
Tel: 407-829-8792  
Fax: 407-829-8798  
www.hhpai.com

#### Jay Stone & Associates

*Northern California*  
2109 O'Toole Avenue, Suite M  
San Jose, CA 95131  
Tel: 408-428-2500  
Fax: 407-428-9000  
www.jsarep.com

#### The MacInnis Company

*ME, NH, RI, CT, MA, VT*  
375 Vanderbilt Avenue  
Norwood, MA 02062  
Tel: (781) 762-8090  
Fax: (781) 762-5059  
www.macinnis-company.com

#### MINK Associates

*NE, KA, MO*  
10100 Santa Fe, Suite 311  
Overland Park, KS 66212  
Tel: (913) 341-8309  
Fax: (913) 341-2605  
www.minkassoc.com

#### Precision Marketing Incorporated

*MS, AL, TN, GA, NC and SC*  
5497 Wiles Road, Suite 204  
Coconut Creek, FL 33073  
Tel: (954) 752-1700  
Fax: (954) 973-6335  
www.precision-marketing.com

#### RPI-Apex Associates, Inc.

*Upstate New York (excluding Long Island)*  
54 Andover Street  
Andover, MA 01810  
Tel: 978-475-7055  
Fax: 978-475-4749  
www.rpi-apex.com

#### Sea-Port Tech Sales

*WA, OR, ID, Western Canada*  
3630 130th Ave. NE  
Bellevue, WA 98005  
Tel: (425) 702-8300  
Fax: (425) 702-8388  
www.seaporttech.com

#### Synergy Sales

**Representatives, Inc.**  
*MN, ND, SD*  
5401 Gamble Drive, Suite #105  
St. Louis Park, MN 55416  
Tel: (952) 544-1686  
Fax: (952) 545-2935  
www.synergyreps.com

#### Westrep Arizona

*AZ, NM, Clark County, NV & El Paso, TX*  
6105 S. Ash Avenue, Suite A8  
Tempe, AZ 85283  
Tel: (480) 820-9932  
Fax: (480) 820-9962  
www.westrepaz.com

**HEADQUARTERS**

12525 Daphne Ave.  
Hawthorne, CA 90250  
Phone: (323) 777-0077 or (800) 284-7007  
Fax: (323) 241-1287  
E-mail: relays@teledyne.com

**[www.teledyne.com](http://www.teledyne.com)**  
**(800) 284-7007**

**EUROPE**

9-13 Napier Road  
Wardpark North  
Cumbernauld G68 OEF  
Scotland UK  
Phone: +44 (0) 1236 453 124  
Fax: +44 (0) 1236 780 651  
E-mail: sales\_europe@teledyne.com

**[www.teledyne-europe.com](http://www.teledyne-europe.com)**  
**+44 (0) 1236 453 124**



**TELEDYNE  
RELAYS**

A Teledyne Technologies Company