



Common Mode Filters

For signal line

ZJYS51 Series

ZJYS51R5 Type

REMINDERS FOR USING THESE PRODUCTS

Before using these products, be sure to request the delivery specifications.

SAFETY REMINDERS

Please pay sufficient attention to the warnings for safe designing when using these products.

REMINDERS

- The storage period is less than 12 months. Be sure to follow the storage conditions (Temperature: 5 to 40°C, Humidity: 10 to 75% RH or less).
If the storage period elapses, the soldering of the terminal electrodes may deteriorate.
- Do not use or store in locations where there are conditions such as gas corrosion (salt, acid, alkali, etc.).
- Before soldering, be sure to preheat components.
The preheating temperature should be set so that the temperature difference between the solder temperature and chip temperature does not exceed 150°C.
- Soldering corrections after mounting should be within the range of the conditions determined in the specifications.
If overheated, a short circuit, performance deterioration, or lifespan shortening may occur.
- When embedding a printed circuit board where a chip is mounted to a set, be sure that residual stress is not given to the chip due to the overall distortion of the printed circuit board and partial distortion such as at screw tightening portions.
- Self heating (temperature increase) occurs when the power is turned ON, so the tolerance should be sufficient for the set thermal design.
- Carefully lay out the coil for the circuit board design of the non-magnetic shield type.
A malfunction may occur due to magnetic interference.
- Use a wrist band to discharge static electricity in your body through the grounding wire.
- Do not expose the products to magnets or magnetic fields.
- Do not use for a purpose outside of the contents regulated in the delivery specifications.
- The products listed on this catalog are intended for use in general electronic equipment (AV equipment, telecommunications equipment, home appliances, amusement equipment, computer equipment, personal equipment, office equipment, measurement equipment, industrial robots) under a normal operation and use condition.
The products are not designed or warranted to meet the requirements of the applications listed below, whose performance and/or quality require a more stringent level of safety or reliability, or whose failure, malfunction or trouble could cause serious damage to society, person or property.
If you intend to use the products in the applications listed below or if you have special requirements exceeding the range or conditions set forth in the each catalog, please contact us.

- (1) Aerospace/Aviation equipment
- (2) Transportation equipment (cars, electric trains, ships, etc.)
- (3) Medical equipment
- (4) Power-generation control equipment
- (5) Atomic energy-related equipment
- (6) Seabed equipment
- (7) Transportation control equipment

- (8) Public information-processing equipment
- (9) Military equipment
- (10) Electric heating apparatus, burning equipment
- (11) Disaster prevention/crime prevention equipment
- (12) Safety equipment
- (13) Other applications that are not considered general-purpose applications

When designing your equipment even for general-purpose applications, you are kindly requested to take into consideration securing protection circuit/device or providing backup circuits in your equipment.

Common Mode Filters

Compatible with lead-free solders

For signal line

Overview of ZJYS51R5 Type

FEATURES

- Optimal common mode filter for removing noise without straining the transmission signal and for transmitting high-quality signals.
- Optimal countermeasure for common mode noise induced during data transmission for digital signal processing such as in PCs and telephones.
- SMD type structure makes it optimal for surface mounting.
- Up to 2A current is allowable, so it can be used as a noise countermeasure for power supply lines.

APPLICATION

PCs, telephones, LANs, ISDNs, digital PBXs, game machines, CTVs, CD-ROMs, 8mm video cassette recorders, etc.

PART NUMBER CONSTRUCTION

ZJYS51R5	-	2P	T	-	01
Series • Type name		Product internal code	Packaging style		Internal code
		2P	T	ø330mm reel	01
		2PB			
		2PL			
		4P			
		M4PA			

OPERATING TEMPERATURE RANGE, PACKAGE QUANTITY, PRODUCT WEIGHT

Type	Temperature range		Package quantity (pieces/reel)	Individual weight (g)
	Operating temperature (°C)	Storage temperature* (°C)		
ZJYS51R5-2PT-01	-25 to +85	-25 to +85	1,500	0.4
ZJYS51R5-2PBT-01	-25 to +85	-25 to +85	1,500	0.4
ZJYS51R5-2PLT-01	-25 to +85	-25 to +85	1,500	0.4
ZJYS51R5-4PT-01	-25 to +85	-25 to +85	1,000	0.8
ZJYS51R5-M4PAT-01	-25 to +85	-25 to +85	1,000	0.8

* The Storage temperature range is for after the circuit board is mounted.

- RoHS Directive Compliant Product: See the following for more details related to RoHS Directive compliant products. <http://product.tdk.com/en/environment/rohs/>
- Halogen-free: Indicates that Cl content is less than 900ppm, Br content is less than 900ppm, and that the total Cl and Br content is less than 1500ppm.

 Please be sure to request delivery specifications that provide further details on the features and specifications of the products for proper and safe use. Please note that the contents may change without any prior notice due to reasons such as upgrading.

ZJYS51R5 Type

RECOMMENDED REFLOW PROFILE

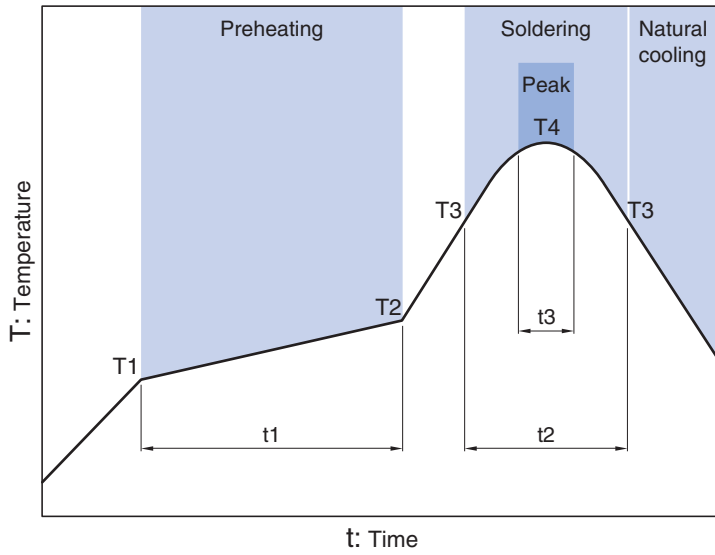

Preheating			Soldering		Peak	
Temp.	Temp.	Time	Temp.	Time	Temp.	Time
T1	T2	t1	T3	t2	T4	t3
150°C	180°C	60 to 120s	230°C	10 to 30s	245°C	5s

ZJYS51R5-2PT-01, -2PBT-01, -2PLT-01

SHAPE & DIMENSIONS

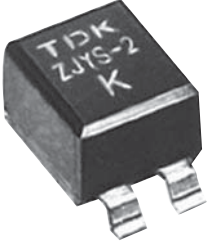
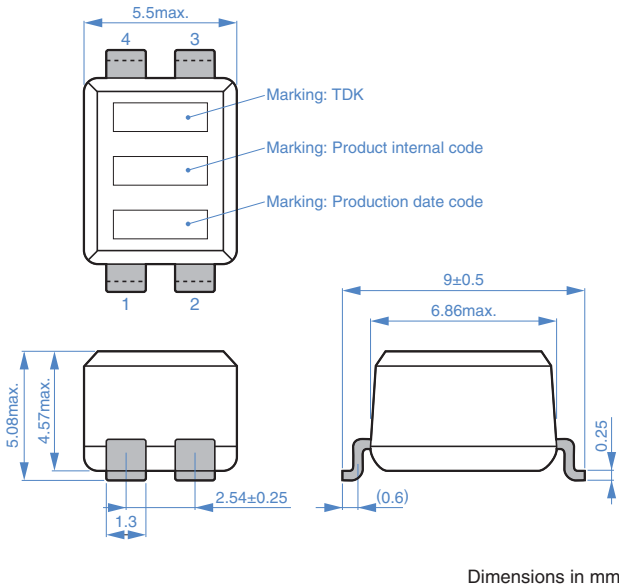

RECOMMENDED LAND PATTERN

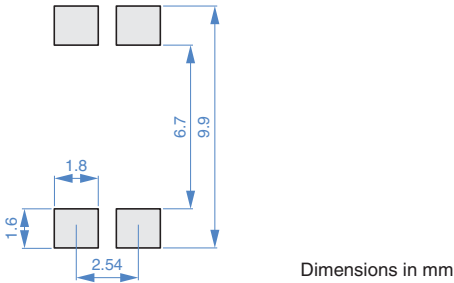

CIRCUIT DIAGRAM

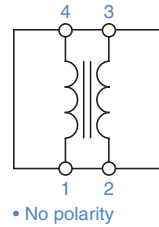

 Please be sure to request delivery specifications that provide further details on the features and specifications of the products for proper and safe use. Please note that the contents may change without any prior notice due to reasons such as upgrading.

ZJYS51R5-2PT-01, -2PBT-01, -2PLT-01

ELECTRICAL CHARACTERISTICS

CHARACTERISTICS SPECIFICATION TABLE

Part No.	ZJYS51R5-2PT-01	ZJYS51R5-2PBT-01*1	ZJYS51R5-2PLT-01*2
Rated voltage Edc(V)	50	50	50
Rated current (A)	2	2	2
Test voltage Edc(V) [Between terminals for 5s]	125	125	250
Insulation resistance (M Ω) [Between terminals at DC.50V for 1min]	100 min.	100 min.	100 min.
DC resistance (Ω) [1 line]	0.12 max.	0.12 max.	0.10 max.
Impedance (Ω)[+5 to +35°C]	200 min.[20 to 300MHz]	300 min.[6 to 20MHz]	100 min.[20 to 100MHz]

Measurement equipment

Measurement item	Product No.	Manufacturer
Common mode impedance	4991A	Agilent Technologies
DC resistance	4338A	Agilent Technologies
Insulation resistance	4339A	Agilent Technologies

* Equivalent measurement equipment may be used.

IMPEDANCE VS. FREQUENCY CHARACTERISTICS (FOR 1 ELEMENT)

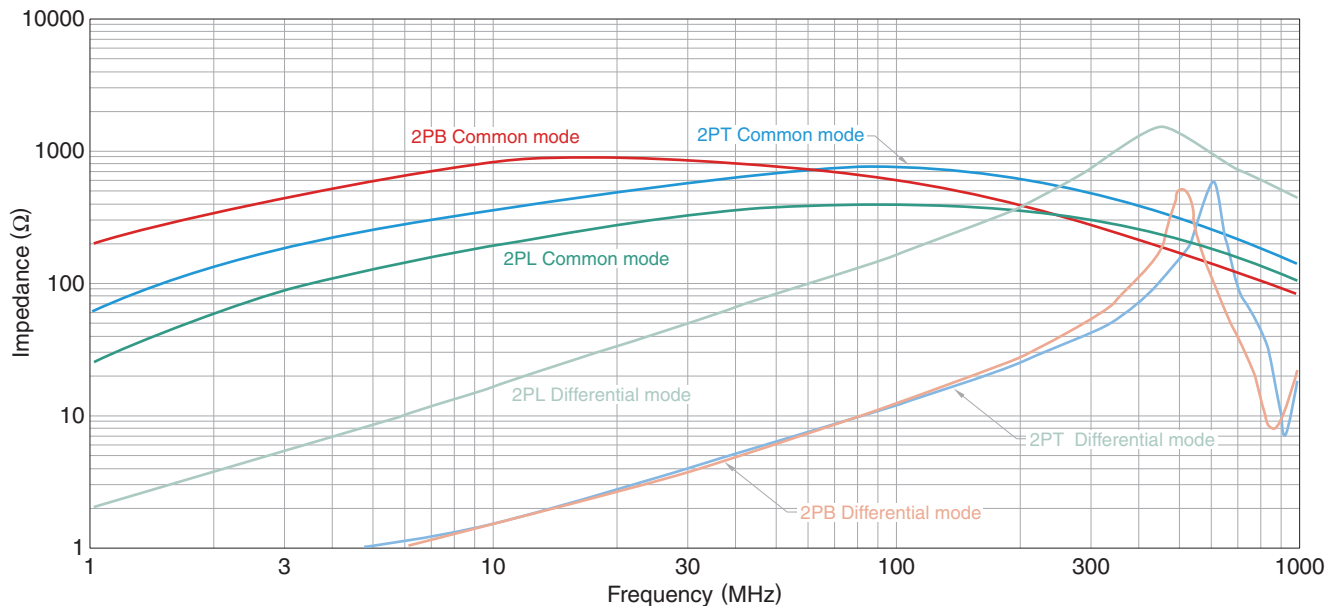

Measurement equipment

Product No.	Manufacturer
4991A	Agilent Technologies

* Equivalent measurement equipment may be used.

ZJYS51R5-4PT-01, -M4PAT-01

SHAPE & DIMENSIONS

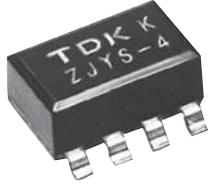
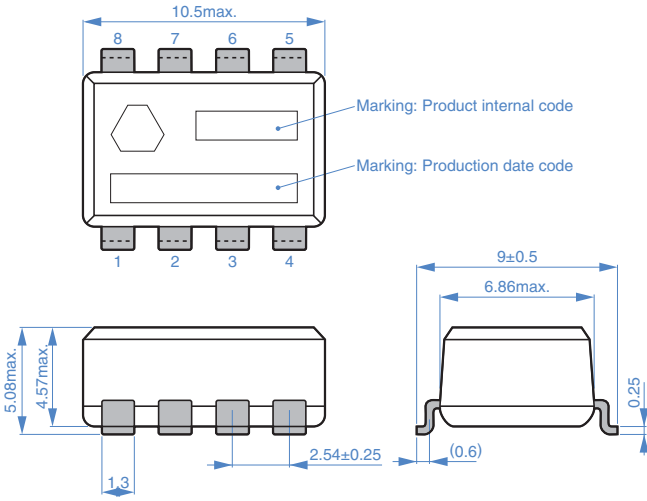

Dimensions in mm

RECOMMENDED LAND PATTERN

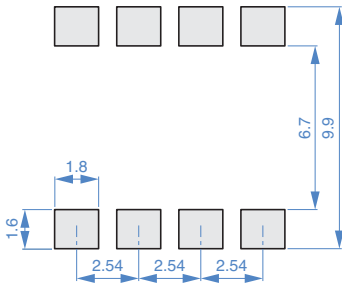

Dimensions in mm

CIRCUIT DIAGRAM

ZJYS51R5-4PT-01

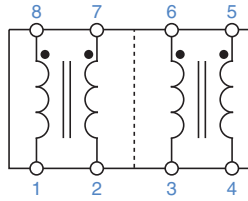

• No polarity

ZJYS51R5-M4PAT-01

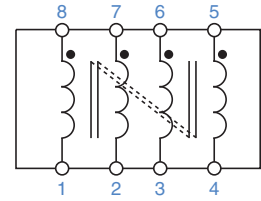

• No polarity

 Please be sure to request delivery specifications that provide further details on the features and specifications of the products for proper and safe use. Please note that the contents may change without any prior notice due to reasons such as upgrading.

ZJYS51R5-4PT-01, -M4PAT-01

ELECTRICAL CHARACTERISTICS

CHARACTERISTICS SPECIFICATION TABLE

Part No.	ZJYS51R5-4PT-01	ZJYS51R5-M4PAT-01
Rated voltage Edc(V)	50	50
Rated current (A)	2	0.5
Test voltage Edc(V) [Between terminals for 5s]	125	125
Insulation resistance (M Ω) [Between terminals at DC.50V for 1min]	100 min.	100 min.
DC resistance (Ω) [1 line]	0.12 max.	0.25 max.
Impedance (Ω)[+5 to +35°C]	200 min.[20 to 300MHz]	200 min.[20 to 300MHz]

Measurement equipment

Measurement item	Product No.	Manufacturer
Common mode impedance	4991A	Agilent Technologies
DC resistance	4338A	Agilent Technologies
Insulation resistance	4339A	Agilent Technologies

* Equivalent measurement equipment may be used.

IMPEDANCE VS. FREQUENCY CHARACTERISTICS (FOR 1 ELEMENT)

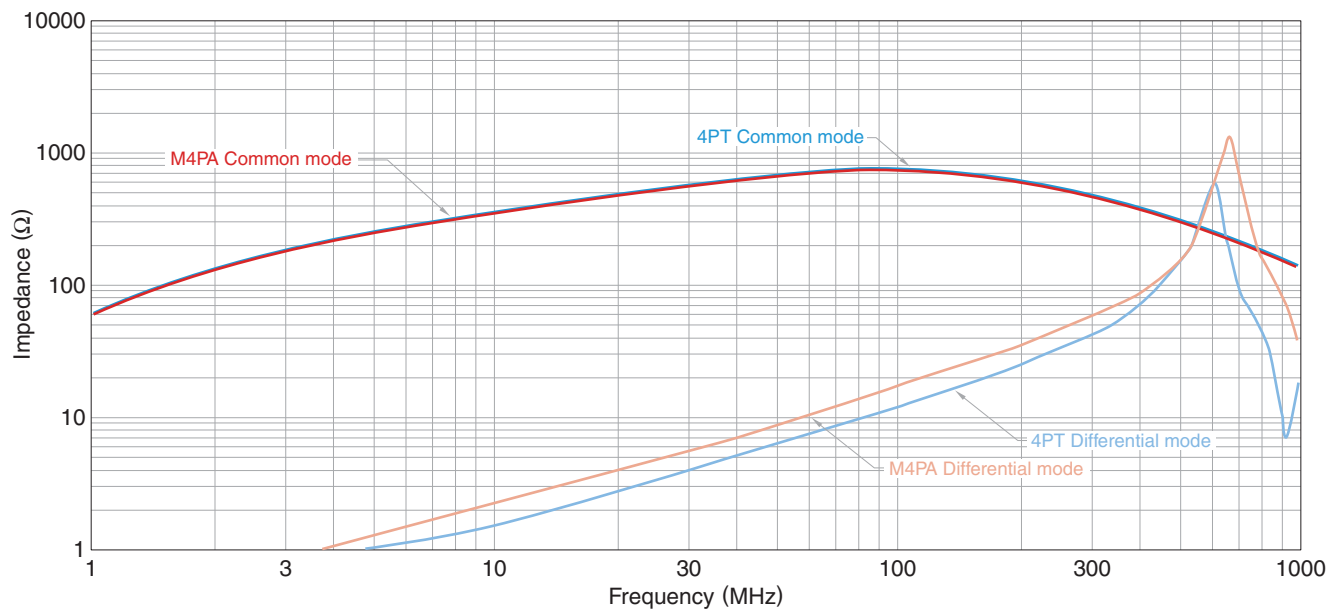

Measurement equipment

Product No.	Manufacturer
4991A	Agilent Technologies

* Equivalent measurement equipment may be used.

ZJYS51R5 Type

PACKAGING STYLE

REEL DIMENSIONS

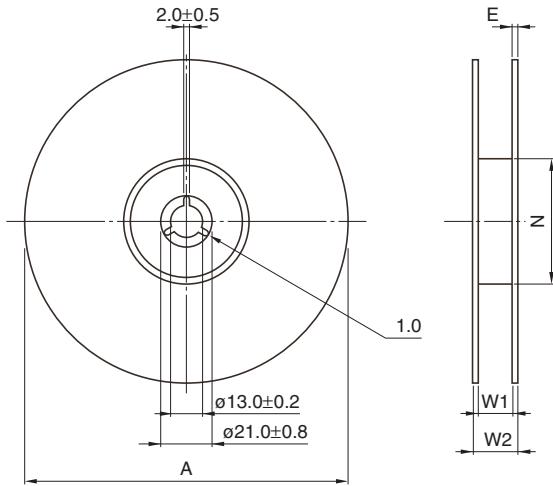

Type	A	W1	W2	N	E
ZJYS51R5-2	$\phi 330 \pm 2$	16.4+2/-0	20.4 typ.	100±1	2 typ.
ZJYS51R5-4P,M4PA	$\phi 330 \pm 2$	16.4+2/-0	20.4 typ.	100±1	2 typ.

Dimensions in mm

TAPE DIMENSIONS

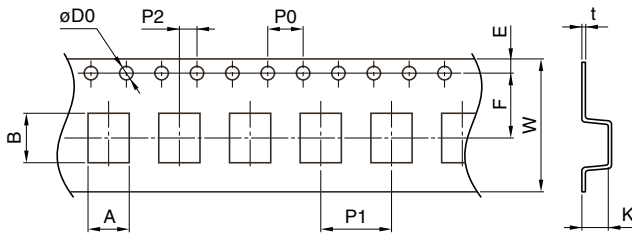

Dimensions in mm

Type	A	B	$\phi D0$	E	F	P0	P1	P2	W	K	t
ZJYS51R5-2	5.8±0.1	9.8±0.1	1.5+0.1/0	1.75±0.1	7.5±0.1	4.0±0.1	8.0±0.1	2.0±0.1	16.0±0.3	5.2	0.4
ZJYS51R5-4P,M4PA	9.8±0.1	10.5±0.1	1.5+0.1/0	1.75±0.1	7.5±0.1	4.0±0.1	12.0±0.1	2.0±0.1	16.0±0.3	5.2	0.4

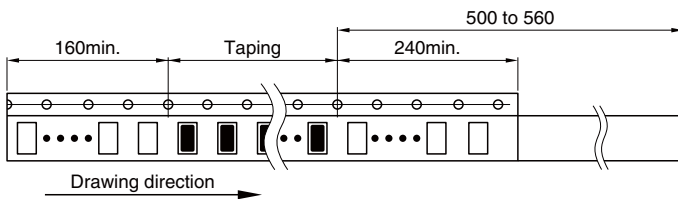

Please be sure to request delivery specifications that provide further details on the features and specifications of the products for proper and safe use. Please note that the contents may change without any prior notice due to reasons such as upgrading.