



LatticeECP3 Versa Evaluation Board

User's Guide

Introduction

The LatticeECP3™ Versa Evaluation Board allows designers to investigate and experiment with the features of the LatticeECP3 Field-Programmable Gate Array. The features of the LatticeECP3 Versa Evaluation Board can assist engineers with rapid prototyping and testing of their specific designs. The LatticeECP3 Versa Evaluation Board is part of the LatticeECP3 Versa Development Kit. The guide is intended to be referenced in conjunction with demo user's guides to demonstrate the LatticeECP3 FPGA.

Figure 1. LatticeECP3 Versa Evaluation Board, Top Side

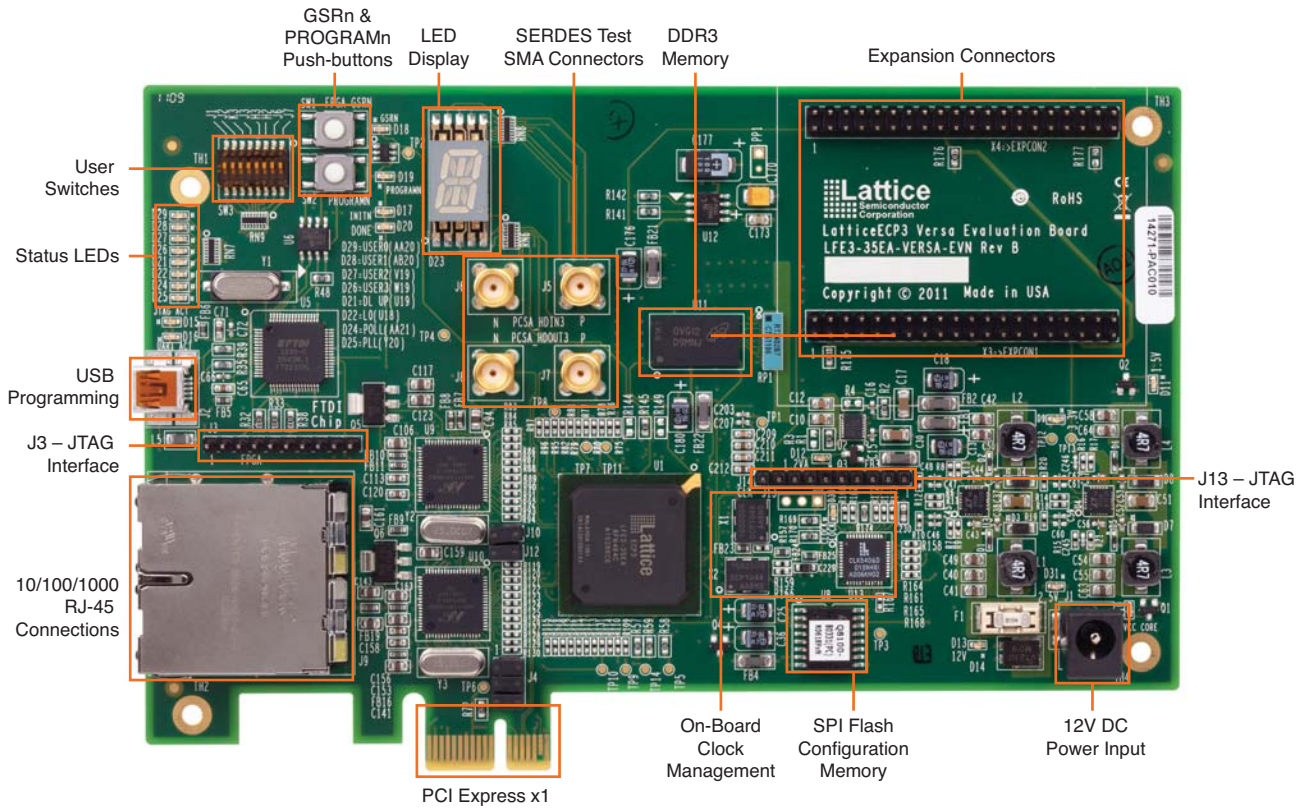

Features

- Half-length PCI Express form-factor
 - Allows demonstration of PCI Express x1 interconnection
- Electrical testing of one full-duplex SERDES channel via SMA connections
- USB-B connection for UART and device programming
- Two RJ45 interfaces to 10/100/1000 Ethernet to GMII
- On-board Boot Flash
 - 64M Serial SPI Flash
- DDR3-1333 memory components (64Mb/x16)
- Expansion mezzanine interconnection for prototyping
- 14-segment alpha-numeric display
- Switches, LEDs and displays for demo purposes
- ispVM™ programming support
- On-board reference clock sources

The contents of this user's guide include top-level functional descriptions of the various portions of the evaluation board, descriptions of the on-board connectors, diodes and switches and a complete set of schematics.

Caution: The LatticeECP3 Vesta Evaluation Board contains ESD-sensitive components. ESD safe practices should be followed while handling and using the evaluation board.

LatticeECP3 Device

This board features a LatticeECP3 FPGA with a 1.2V core supply. It can accommodate all pin-compatible LatticeECP3 devices in the 484-ball fpBGA (1mm pitch) package. A complete description of this device can be found in the [LatticeECP3 Family Data Sheet](#).

*Note: The connections referenced in this document refer to the **LFE3-35EA-8FN484C** device.*

Applying Power to the Board

The LatticeECP3 Versa Evaluation Board is ready to power on. The board can be supplied with power from a PCI Express host system or standalone with an external wall power module.

The 12V DC input power source is fused with a surface mounted fuse, as noted in Table 1.

Table 1. Board Power Supply Fuses – (See Appendix B, Figure 12)

Fuse Designator	Description
F1	12V Input Supply Fuse

The board may be plugged into a host PC. Only plug the board into a PCI Express slot when the system is powered off. Once inserted, the PC can be safely powered on.

Using the evaluation board outside of a PC chassis supply requires the factory-supplied wall supply module. Use of other supplies is not suggested. GME Tehnologies GFP181DA-1215B-1 (or equivalent) is provided with the LatticeECP3 Versa Development Kit.

Figure 2. Power Distribution Scheme – (See Appendix B, Figure 12)

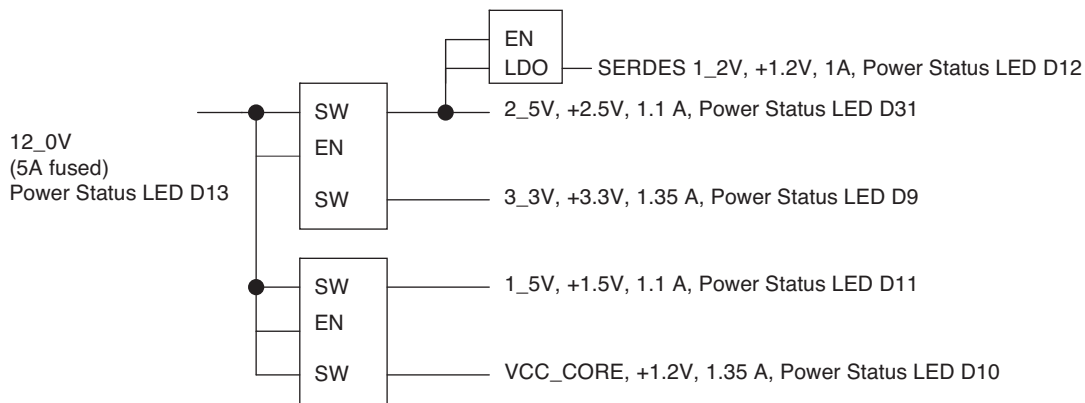

Programming/FPGA Configuration

The LatticeECP3 Versa Evaluation Board has a built-in download controller for programming the LatticeECP3 FPGA. The built-in module consists of a USB Type-B connector and a USB UART device. To use the built-in download cable, simply connect a standard USB cable (a USB-B to USB-A cable is included with the LatticeECP3 Versa Development Kit) from J2 to your PC (with ispVM System software installed). The USB hub on the PC will detect the addition of the USB function, making the built-in cable available for use with the ispVM System software. The USB cable is connected in parallel to J3.

Alternate ispVM Download Interface

J3 is a 1x10 100mil header that is provided for use with an external Lattice download cable (available separately). A USB download cable can be attached to the board using J3 to interface with the FPGA (U1).

A separate header is provided to interface to a download cable for the ispClock™5406A clock device (U13). U13 is not interfaced to the built-in download interface. U13 is factory-programmed for use with the reference designs and should only be altered for customized designs.

A 10-pin JTAG connector is used in conjunction with the ispVM USB download cable to program and control the device. A separate 10-pin header (J14) is provided for programming U13.

Table 2. ispVM JTAG Connector Pinout (J3 and J14) – (See Appendix B, Figure 5)

Pin	Function	Color
1	PWR	Red
2	TDO	Brown
3	TDI	Orange
4	N/C	—
5	N/C	—
6	TMS	Purple
7	GND	Black
8	TCK	White
9	N/C	—
10	N/C	—

ispVM Requirements

Note: An ispDOWNLOAD™ cable is included with Lattice Diamond® design software. This cable is not needed for the typical use of this board since it includes the built-in download module and only requires the USB cable included with the board. Standalone ispVM download cables may be purchased separately from Lattice.

After initial board setup, use the following procedure to program the board. Instructions assume that ispVM software has been installed on a local PC.

Requirements:

- PC with ispVM System 18.0 (or later) programming software, installed with appropriate drivers (USB driver for USB cable, Windows 7/XP/2000/NT parallel port driver for ispDOWNLOAD cable).
Note: An option to install these drivers is included as part of the ispVM System setup.
- ispDOWNLOAD cable (pDS4102-DL2A, HW7265-DL3A, HW-USB-1A, etc.). Required only for alternative FPGA programming and ispClock5406A reprogramming.

Board Programming

Configuration Status Indicators

(see Appendix B, Figure 13)

Figure 3. LatticeECP3 Status LEDs and Push-button Controls



The LEDs indicate the configuration status of the LatticeECP3 FPGA.

- **D17 (red)** illuminated indicates that programming was aborted or reinitialized, driving the INITN output low.
- **D20 (green)** illuminated indicates the successful completion of configuration by releasing the open collector DONE output pin.
- **D19 (red)** illuminated indicates that PROGRAMN is low.
- **D18 (red)** illuminated indicates that GSRN is low.

PROGRAMN and GSRN

These push-button switches assert/de-assert the logic levels on PROGRAMN (SW2) and GSRN (SW1). Depressing the button drives a logic level “0” to the device.

Programming Serial SPI Flash Memory

A serial SPI (16-pin TSSOP, 64M) Flash memory device (U8) is on-board for non-volatile configuration memory storage. A STMicro M25P64VMF16 device is populated on-board.

The Serial SPI Flash memory device can be configured easily via its JTAG port. This mode enables the FPGA to be programmed at power-up or assertion of PROGRAMN with a bitstream stored in the memory device.

1. Connect the LatticeECP3 Versa Evaluation Board.
2. In the dialog box, select **SPI Flash Programming Mode** in the Device Access Option pull-down menu.

Figure 4. Device Information Dialog Screen

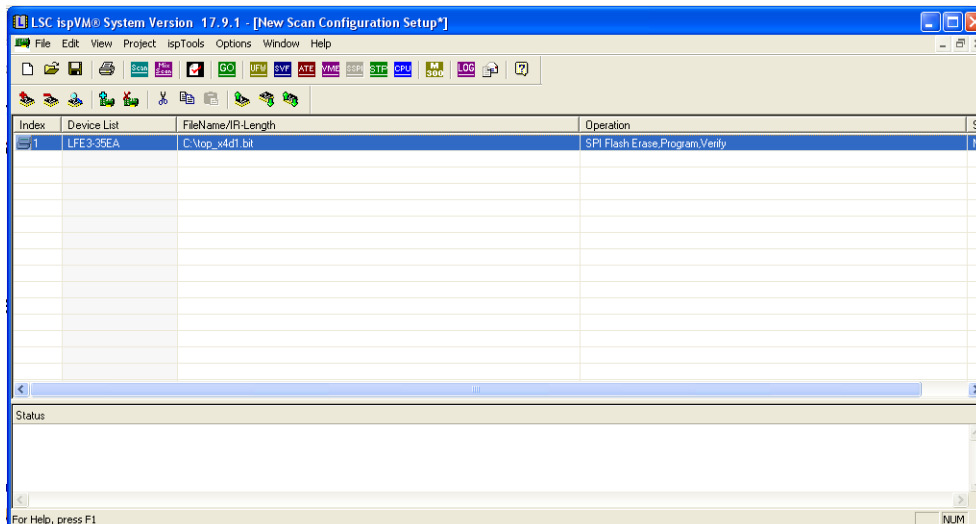

3. The SPI Serial Flash Device dialog box will open. In this box, select **SPI Flash Erase, Program, Verify** in the Operation pull-down menu.
4. Select **SPI Serial Flash** in the Device Family pull-down menu, **STMicro** under the Vendor pull-down menu, **SPI-M2564** under the Device pull-down menu, and **16-lead SOIC** under the Package submenu.

Figure 5. Select Device Dialog Box

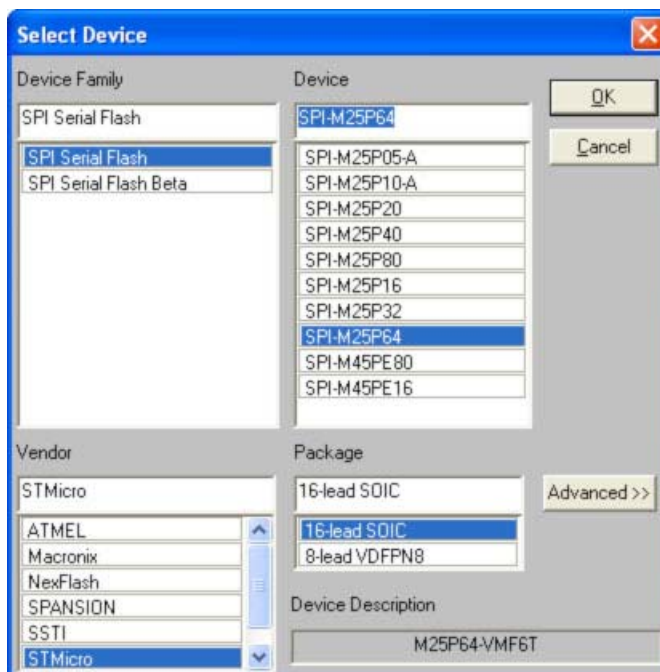
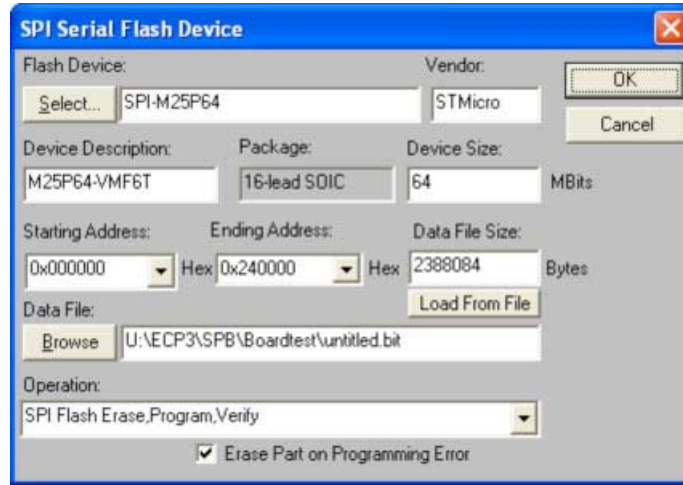

Figure 6. Sample SPI Serial Flash Device Dialog Box



5. Click **OK** in the SPI Serial Flash Device dialog box. Then click **OK** in the Select Device dialog box. You will return to the main configuration screen
6. From the main programming window, select **Go** from the top toolbar. This will begin the SPI Serial Flash programming.

On-Board Clock Capabilities

(See Appendix B, Figure 19)

The LatticeECP3 Versa Evaluation Board allows for several clock source options. Some of these options are controlled via the ispClock5406A programmable clock manager device. The ispClock5406A enables the reference clock from the PCI Express interface to provide a reference clock to the SERDES. This is true only when the board is in a PCI Express host socket. When the board is not in a PCI Express host socket, the clock will be supplied by a 156.25 MHz clock on-board oscillator. Both clock inputs can be fanned out to the dedicated SERDES reference inputs, FPGA inputs, and to the expansion connectors. The factory default programming only connects the SERDES reference clock inputs. Factory-defined demonstration designs will control and manage the clock.

Figure 7. Clock Controller Scheme

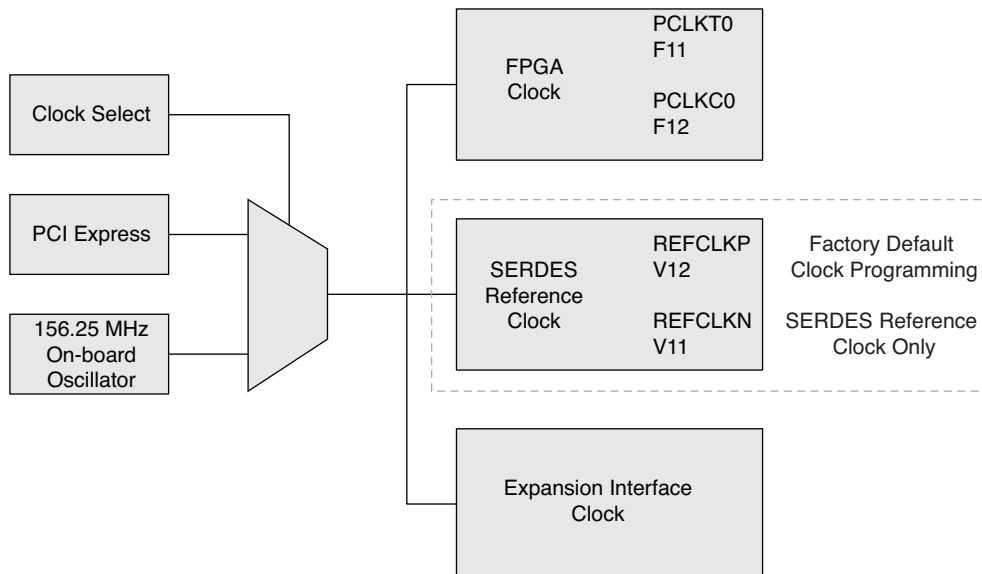

General Purpose Clock Source

An on-board 100MHz LVDS oscillator is provided for general purpose use. This clock source is connected to differential inputs L5 and K6 and must be used as LVDS inputs to the FPGA. This pin pair also provides optimal interface to the FPGA PLL for customized use.

The PCI Express add-in card specification requires add-in boards to include capabilities to tell the host of its presence. The LatticeECP3 Versa Evaluation Board allows this optional connection via a board jumper. The factory default will have two jumpers installed as shown below for the PRSNT connection to the PCI Express host.

Figure 8. PCI Express PRSNT Control Connection

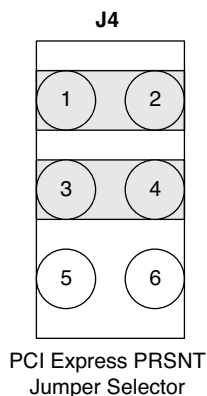

SERDES

The LatticeECP3 quad-based SERDES FPGA is utilized on the board for several purposes. The PCSA quad is provisioned to provide a single, full-duplex PCI Express channel. The high-speed signals are connected to the PCI Express edge connection.

Table 3. PCI Express Channel Interconnections

PETp0	HDINP0	Y15
PETn0	HDINN0	Y14
PERp0	HDOUTP0	AB15
PERn0	HDOUTN0	AB14

Table 4. SMA Test Interconnections

J5	HDINP3	Y8
J6	HDINN0	Y9
J7	HDOUTP3	AB8
J8	HDOUTN3	AB9

FPGA Test Pins

(see Appendix B, Figure 18)

General Purpose DIP Switches

General purpose FPGA pins are available for user applications. FPGA pins are connected to switch SW3, a SPST slide-actuated DIP switch. The switches are connected to logic level 0 when moved to the ON position. Switch position 1 is indicated with a dot. **These inputs are within a bank connected to 1.5V.** The user must program these inputs to be the LVCMOS15 type in the design.

Figure 9. LatticeECP3 Versa Evaluation Board LEDs and Switches

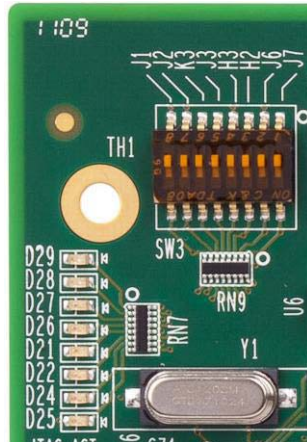

The designated pins are connected according to Table 5.

Table 5. FPGA Ball to DIP Switch Position

FPGA Ball Number	SW3 DIP Switch Position
J7	1
J6	2
H2	3
H3	4
J3	5
K3	6
J2	7
J1	8

General Purpose LEDs

(See Appendix B, Figure 18)

The LEDs provided on the LatticeECP3 Versa Evaluation Board are connected to general purpose FPGA I/Os. These LEDs provide status for user designs and must be included in the design. The LEDs illuminate when the FPGA output is driven LOW. Table 6 shows the LED and associated FPGA pins. These pins are within an I/O bank connected to 3.3V and the user should program these to be LVCMOS33 type outputs in the design.

Table 6. LED Definitions

LED Number	FPGA Ball Number	PCB Designator	LED Color
LED0	U19	D21	Green
LED1	U18	D22	Green
LED2	AA21	D24	Yellow
LED3	Y20	D25	Yellow
LED4	W19	D26	Red
LED5	V19	D27	Red
LED6	AA20	D29	Blue
LED7	AB20	D28	Blue

Alpha-numeric LED Display

(see Appendix A, Figure 18)

A 14-segment alpha-numeric display is provided on the board (D23). These LED segments are connected to general-purpose FPGA I/Os. The LEDs must be included in the FPGA design. The LEDs illuminate when the FPGA output is driven LOW. Table 7 shows the LED and associated FPGA pins. These pins are within an I/O bank connected to 3.3V and the user should program these to be LVCMOS33 outputs in the design.

Figure 10. 14-Segment Display

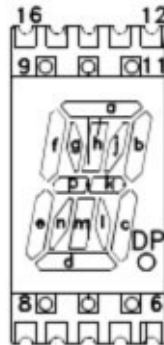

Table 7. Alpha-numeric LED Definitions

Display	fpBGA Ball Number	Display	fpBGA Ball Number
A	V6	J	AB3
B	U7	K	AB4
C	Y6	L	W4
D	Aa6	M	Y5
E	U8	N	AA4
F	T8	P	AA5
G	R9	DP	W5
H	T9		

DDR3 Memory Device

(see Appendix B, Figure 17)

- The LatticeECP3 Versa Evaluation Board is equipped with a SDRAM memory device (1.5V, 64Mb/x16, 96-ball FBGA, 667 MHz, DDR3-1333) such as the Micron MT41J64M16JT-15E:G device.
- The DDR3 memory includes a 16-bit wide memory controller interface.
- The board includes termination of data, address and command signals. It includes all power and external components needed to demonstrate the memory controller of the LatticeECP3 device.
- A 100 MHz on-board clock oscillator is available to provide a DDR3 reference clock.

Table 8. DDR3 Memory Controller Interconnections

NETNAME	484 fpBGA Ball Number	NETNAME	484 fpBGA Ball Number
DQ0	E5	A0	C8
DQ1	E4	A1	C7
DQ2	D2	A2	B7
DQ3	D1	A3	D8
DQ4	C2	A4	F9
DQ5	B2	A5	E9
DQ6	G5	A6	A3
DQ7	G4	A7	D7
DQ8	G2	A8	A7
DQ9	F1	A9	B8
DQ10	H4	A10	C9
DQ11	E2	A11	C10
DQ12	J4	K_0	K4
DQ13	B1	K_0#	K5
DQ14	C1	CAS#	A4
DQ15	G3	BA0	B4
DQS0	F5	BA1	E6
DQS0#	F4	BA2	D5
DQS1	H5	ODT	E7
DQS1#	H6	CS0#	C6
CEO	G8	WE#	D6
RAS#	A6	VREF	E1
CLKP	L5	DM0	E3
CLKN	K6	DM1	F3

Ethernet Interfaces

(see Appendix B, Figure 18)

Two Marvell 88E1119R Gigabit Ethernet transceiver devices (U17) are included on the board. This physical layer device supports 1000BASE-T, 100BASE-TX, and 10BASE-T applications via a standard media interface to a dual RJ45 connection. The RJ45 connection includes network magnetics providing the proper signal conditioning, electro-magnetic interference suppression and signal isolation. This connector includes two LEDs and the board includes four status LEDs from the Marvell device. The LEDs are register-programmed and detailed descriptions are available in the Marvell device data sheet.

Table 9. PHY Status Indicators

LED	Status Description
RJ45 (Yellow)	LED RX
RJ45 (Yellow)	LED TX

Each Marvell 88E1119R device communicates via a GMII interface to the LatticeECP3 device.

Table 10. FPGA GPIO to GMII Interfaces

Signal	PHY#1	PHY#2
RSTN	L3	R21
MDIO	L2	U16
MDC:	V4	Y18
RXC	L4	N19
RX_ER	M4	V20
RX_DV	M1	U15
RX_D0	M5	AB17
RX-D1	N1	AA17
RX_D2	N6	R19
RX_D3	P6	V21
RX_D4	T2	T17
RX_D5	R2	R18
RX_D6	P5	W21
RX_D7	P3	Y21
TXC	C12	M21
TX_EN	V3	V22
TX_D0	V1	W22
TX_D1	U1	R16
TX_D2	R3	P17
TX_D3	P1	Y22
TX_D4	N5	T21
TX_D5	N3	U22
TX_D6	N4	P20
TX_D7	N2	U20
GTXCLK	M2	M19
CRS	P4	P19
COL	R1	N18
COMA	R4 ¹	T15 ¹
125CLK	T3	R17

1. Each PHY device includes a header dedicated to the COMA connection to the device. The header is populated with a jumper that disables and places the PHY in a low power configuration. Headers J10 and J12 are used for this purpose. It is assigned to PHYs U9 and U10, respectively.

Table 11. Expansion Connections

x3 Expansion Connector		
Pin	Signal	484-Ball fpBGA
1	GND	GND
2	NC	NC
3	2.5V	2.5V
4	IO29	D17
5	IO30	J22
6	IO31	K22
7	IO32	L18
8	IO33	L19
9	IO34	L22
10	IO35	M22
11	IO36	K18
12	IO37	K17
13	IO38	H22
14	IO39	H21
15	IO40	G22
16	IO41	G21
17	IO42	J18
18	IO43	J17
19	IO44	F22
20	IO45	E22
21	5VIN	5VIN
22	GND	GND
23	2.5V	2.5V
24	GND	GND
25	3.3V	3.3V
26	GND	GND
27	3.3V	3.3V
28	GND	GND
29	OSC	U13 PIN27
30	GND	GND
31	CLKIN	M18
32	GND	GND
33	CLKOUT	P21
34	GND	GND
35	3.3V	3.3V
36	GND	GND
37	3.3V	3.3V
38	GND	GND
39	3.3V	3.3V
40	GND	GND

x4 Expansion Connector		
Pin	Signal	484-Ball fpBGA
1	HPE-RST#	J20
2	GND	GND
3	IO0	B11
4	IO1	B12
5	IO2	A12
6	IO3	A13
7	IO4	E12
8	IO5	E13
9	IO6	C13
10	IO7	C14
11	IO8	D13
12	IO9	D14
13	IO10	A14
14	IO11	B14
15	IO12	F13
16	IO13	F14
17	IO14	A15
18	IO15	B15
19	GND	GND
20	3.3V	3.3V
21	IO16	C15
22	GND	GND
23	IO17	D15
24	GND	GND
25	IO18	G15
26	GND	GND
27	IO19	G14
28	IO20	A16
29	IO21	B16
30	GND	GND
31	IO22	F15
32	IO23	F16
33	IO24	A17
34	GND	GND
35	IO25	B18
36	IO26	A18
37	IO27	A19
38	CARDSEL#	J19
39	IO28	D16
40	GND	GND

References

- DS1021, [LatticeECP3 Family Data Sheet](#)
- HB1009, [LatticeECP3 Family Handbook](#)
- QS013, LatticeECP3 Vesta Evaluation Board Quick Start Guide
- UG46, PCI Express Demos for the LatticeECP3 Versa Evaluation Board
- UG45, DDR3 Demo for the LatticeECP3 Versa Evaluation Board
- UG44, SERDES Eye/Backplane Demo for the LatticeECP3 Versa Evaluation Board

Ordering Information

Description	Ordering Part Number	China RoHS Environment-Friendly Use Period (EFUP)
LatticeECP3 Versa Evaluation Board	LFE3-35EA-VERSA-EVN	

Technical Support Assistance

Hotline: 1-800-LATTICE (North America)
 +1-503-268-8001 (Outside North America)
 e-mail: techsupport@latticesemi.com
 Internet: www.latticesemi.com

Revision History

Date	Version	Change Summary
April 2011	01.0	Initial release.
August 2011	01.1	Updated LatticeECP3 Versa Evaluation Board, Top Side diagram. Corrected ispVM System software version number in the ispVM Requirements text section. Corrected ispVM JTAG Connector Pinout table caption information.
November 2011	01.2	Corrected error in the column headings of the Expansion Connections table.

© 2011 Lattice Semiconductor Corp. All Lattice trademarks, registered trademarks, patents, and disclaimers are as listed at www.latticesemi.com/legal. All other brand or product names are trademarks or registered trademarks of their respective holders. The specifications and information herein are subject to change without notice.

Appendix A. Schematics

Figure 11. Cover Page

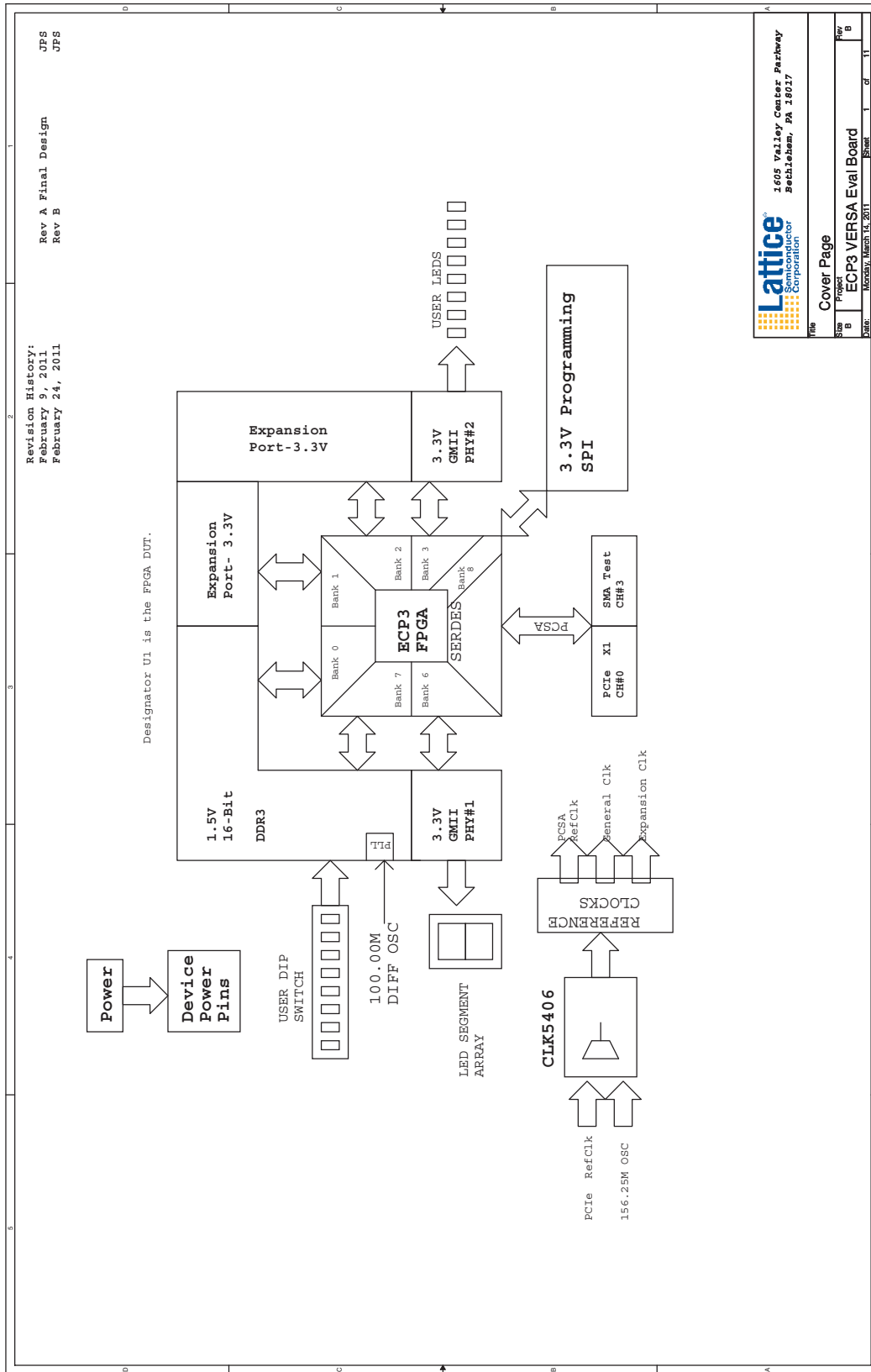

Figure 13. Programming

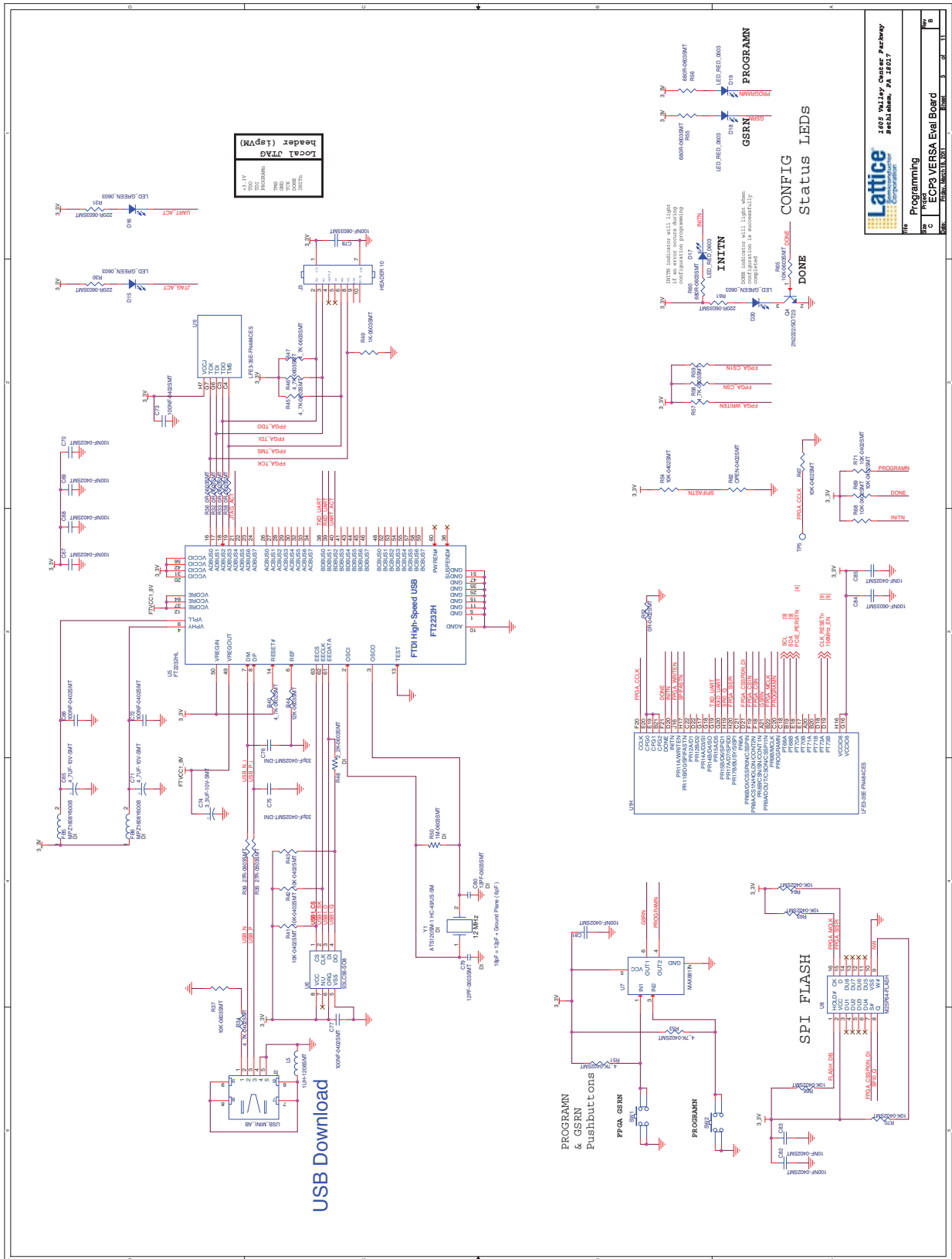
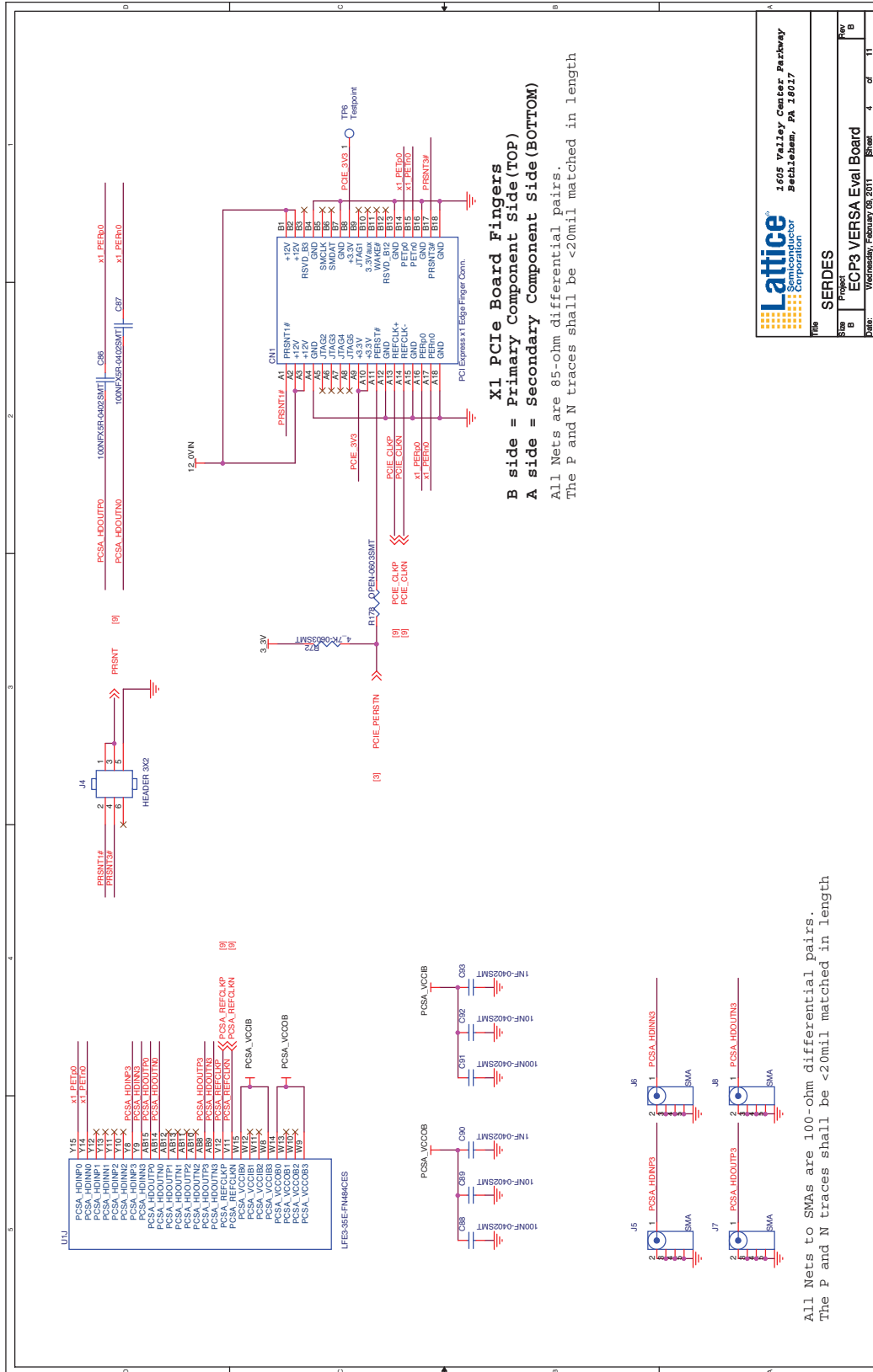

Figure 14. SERDES



Lattice Semiconductor Corporation
 1605 Valley Center Parkway
 Bethlehem, PA 18017

SERDES

Part: ECP3 VERSA Eval Board
 Project: SERDES
 Date: Wednesday, February 09, 2011

Page: 4 of 11

Figure 15. 10/100/1000-T PHY #1/RJ45

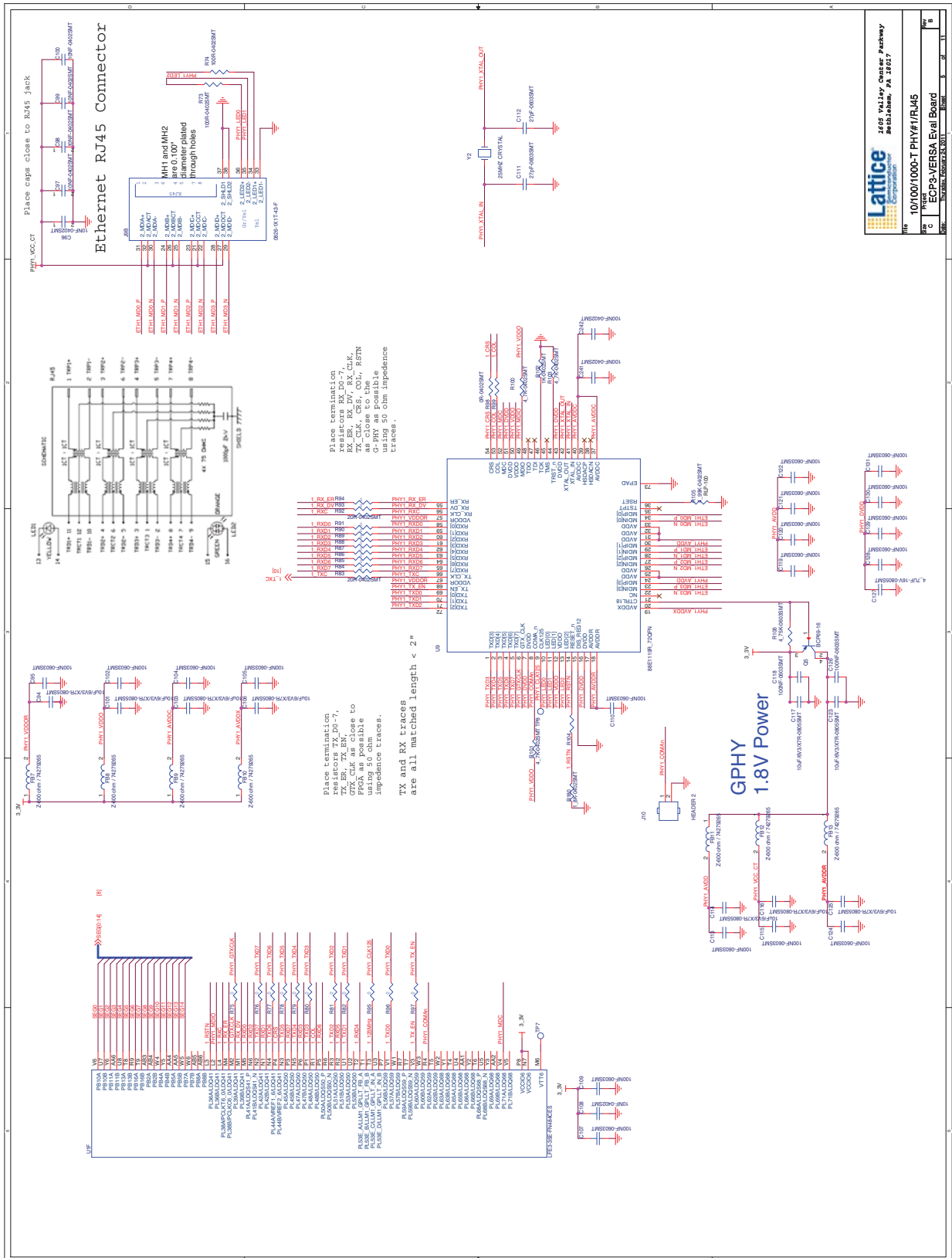

Lattice
1665 Valley Center Parkway
Millsboro, PA 19967

10/100/1000-T PHY#1/RJ45

ECP3-VERSA Eval Board

Figure 16. 10/100/1000-T PHY #2/RJ45

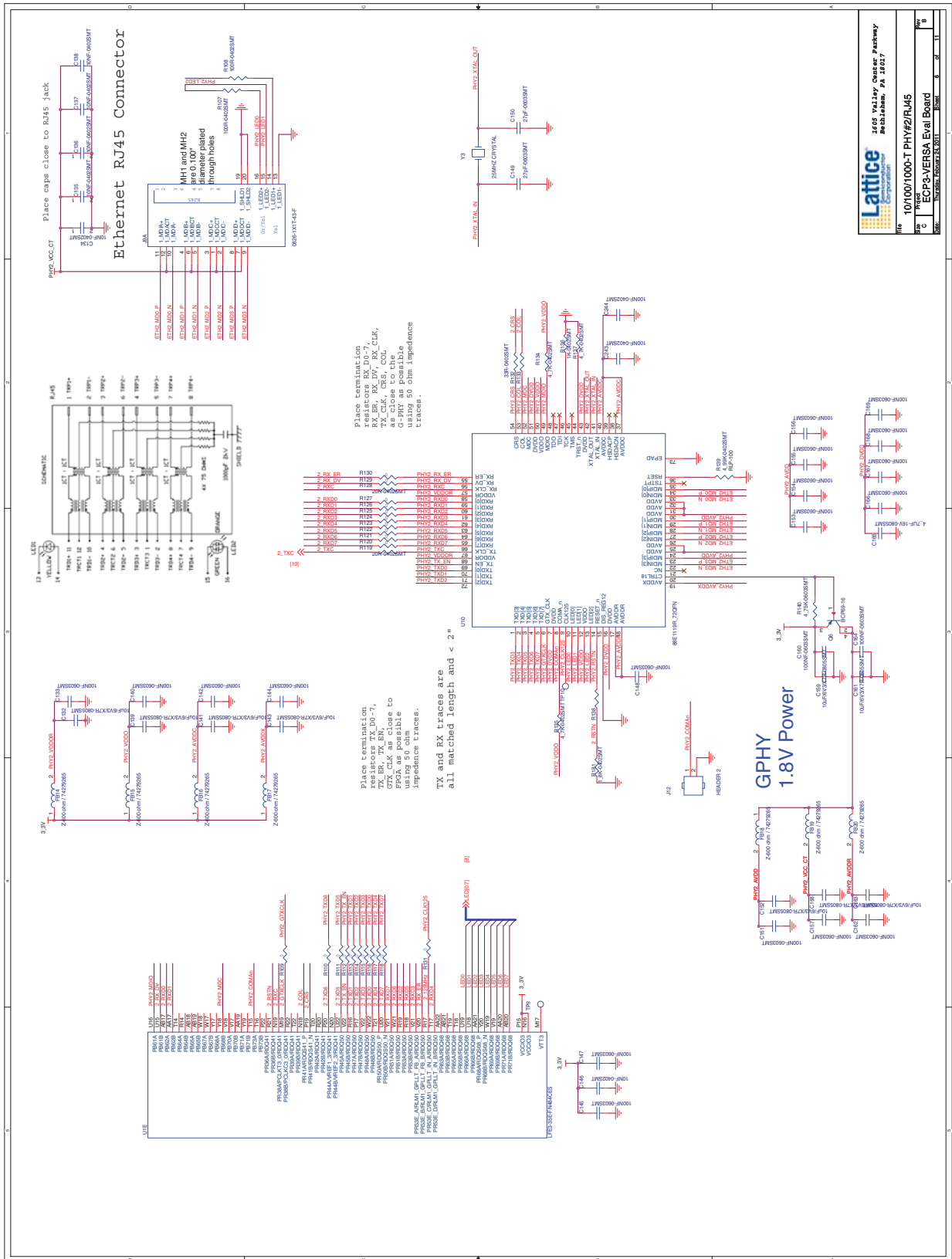

Figure 17. DDR3 Memory

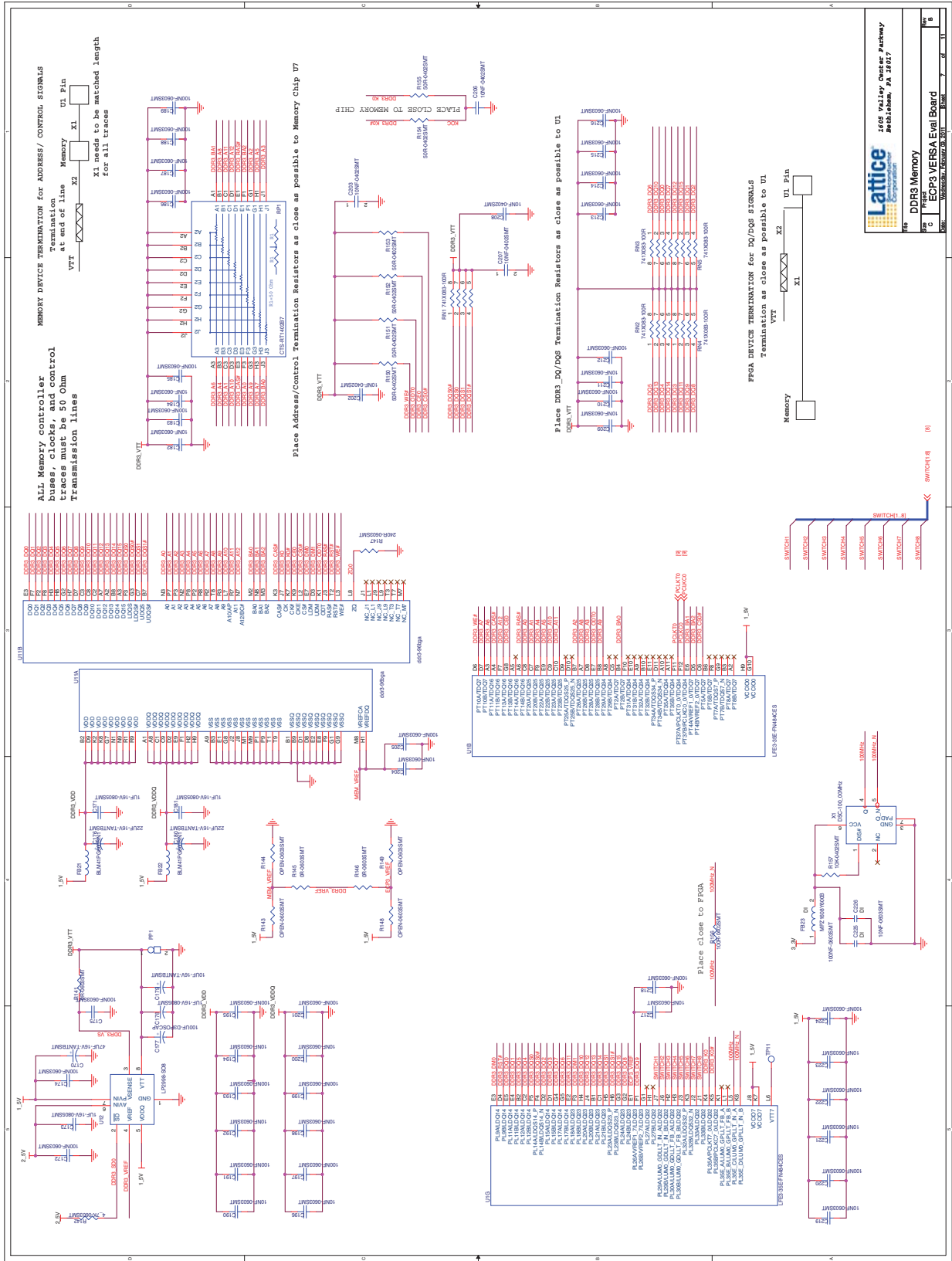

Figure 18. LEDs and Switches

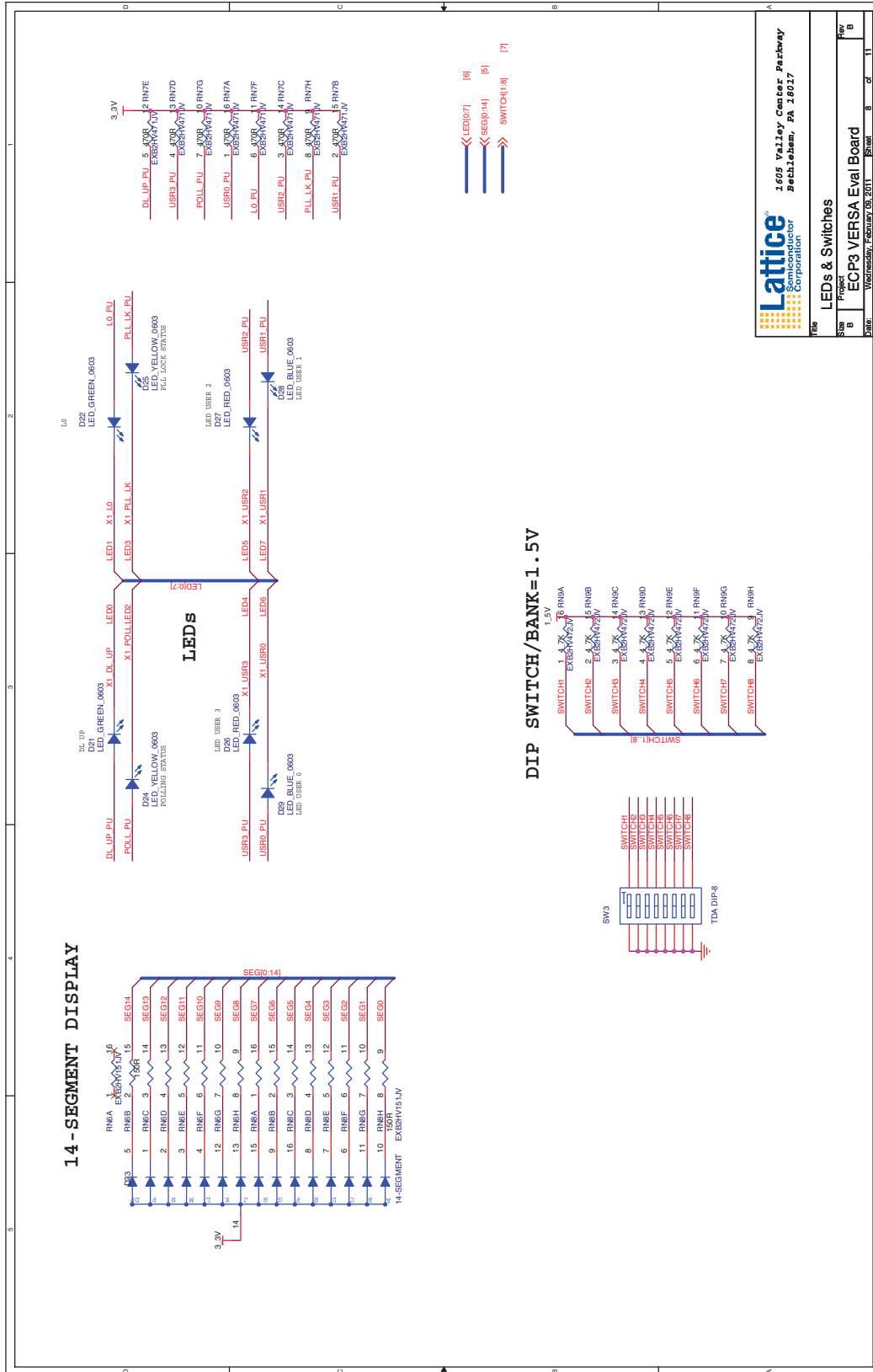
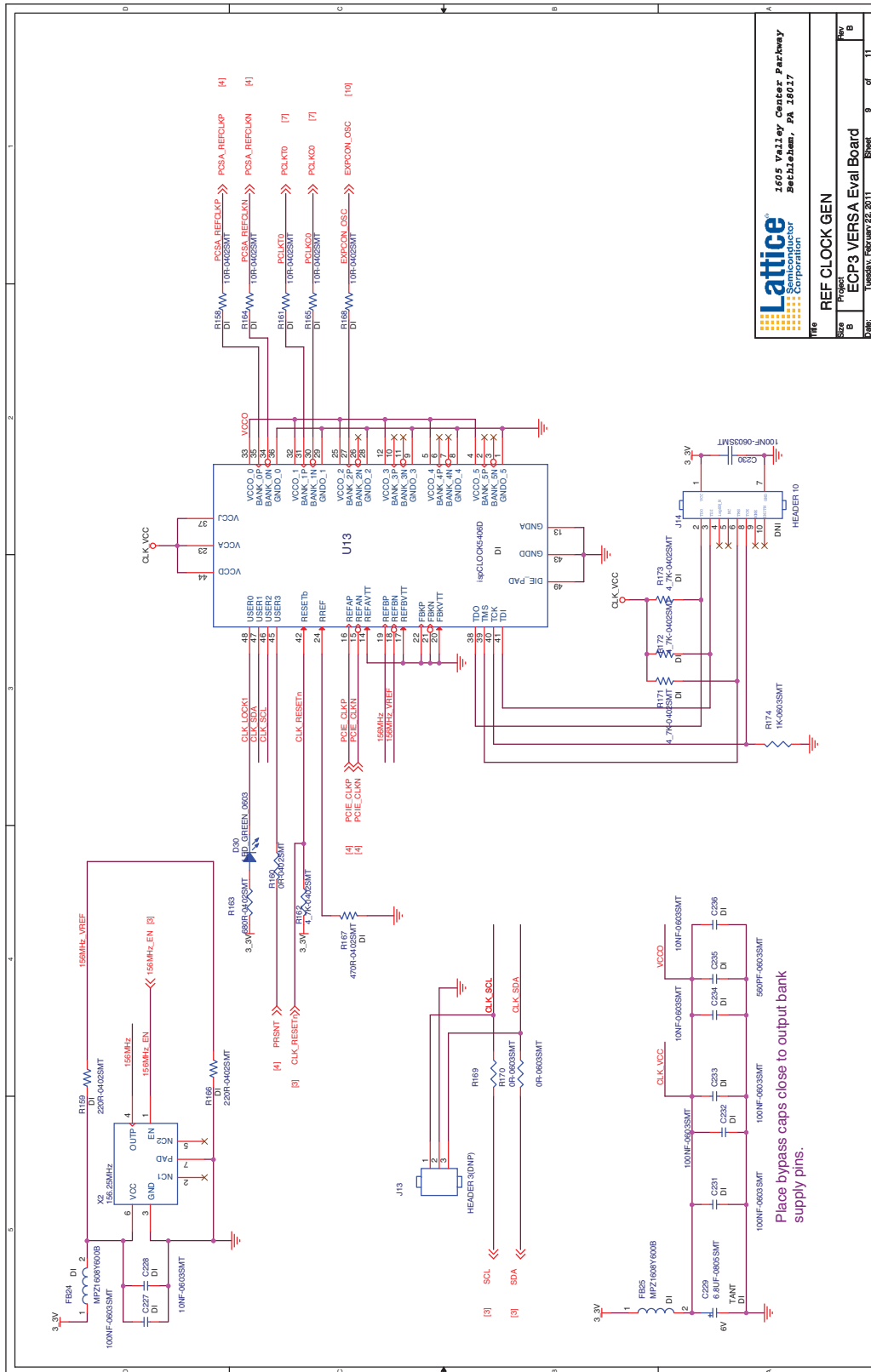

Figure 19. Reference Clock Generator



Lattice
1605 Valley Center Parkway
Sect 14, Jam, PA 15017

REF CLOCK GEN

Rev: B
Project: ECP3 VERSA Eval Board
Date: Tuesday, February 23, 2011

Figure 21. Mechanical Drawing

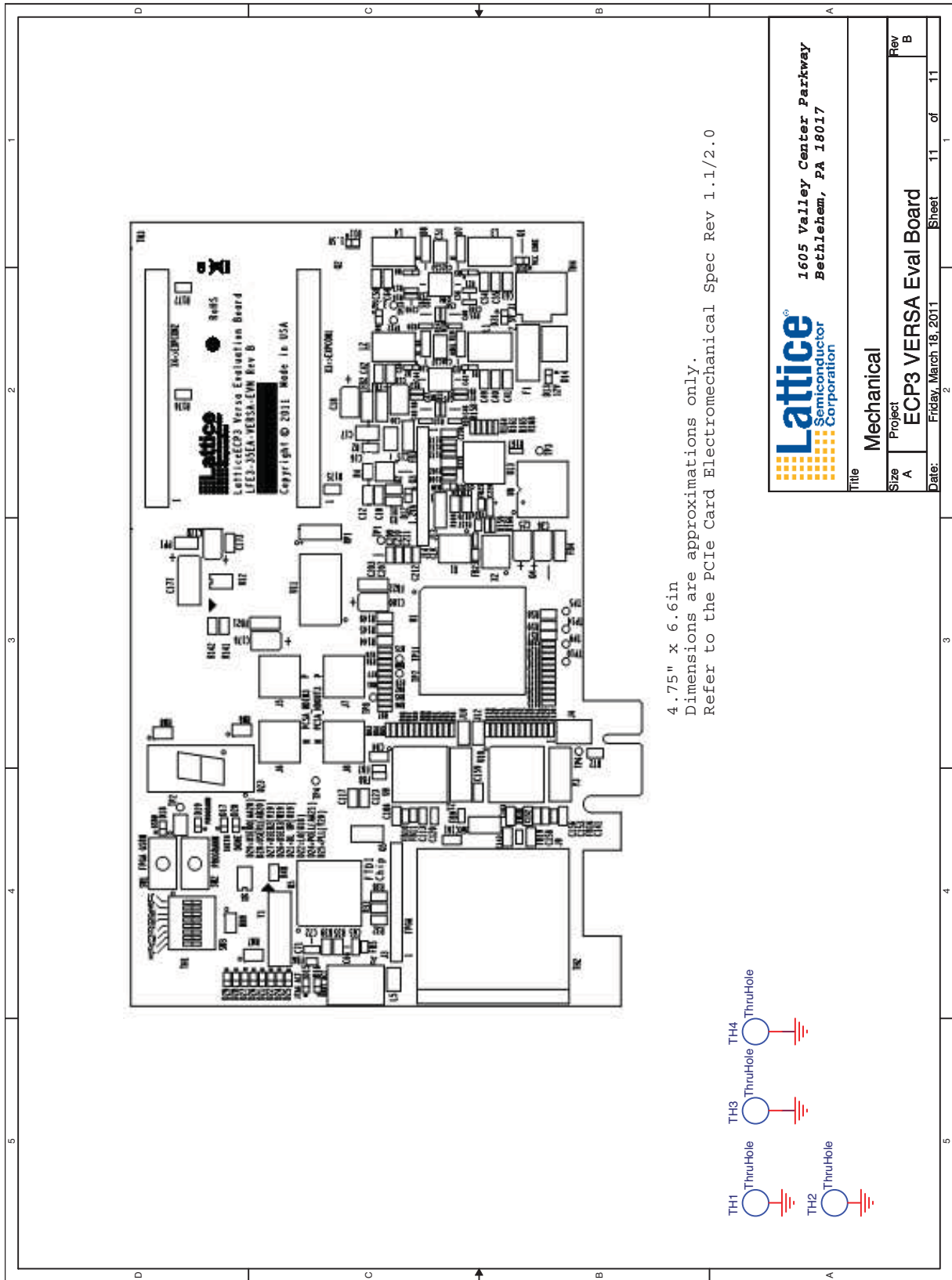

Appendix B. Bill of Materials

Table 12. LatticeECP3 Versa Evaluation Board Bill of Materials

Item	Quantity	Reference	Part	Manufacturer	Part Number	Description
1	1	CN1	PCI Express x1 Edge Finger Connectors		PCB fingers	
2	34	C1, C2, C3, C4, C5, C15, C16, C20, C21, C29, C33, C83, C85, C89, C92, C96, C97, C98, C99, C100, C108, C134, C135, C136, C137, C138, C146, C202, C203, C206, C207, C208, C237, C239	10NF-0402SMT	Panasonic	ECJ0EB1E103K	CAP .01UF 25V CERAMIC X7R 0402
3	25	C6, C7, C8, C9, C11, C22, C23, C28, C34, C66, C67, C68, C69, C70, C72, C73, C77, C81, C82, C88, C91, C241, C242, C243, C244	100NF-0402SMT	Panasonic	ECJ-0EB1A104K	CAP .1UF 10V CERAMIC X5R 0402
4	9	C14, C19, C24, C27, C35, C171, C173, C178, C181	1UF-16V-0805SMT	Panasonic	ECJ-2FB1C105K	CAP 1UF 16V CERAMIC 0805 X5R
5	7	C13, C18, C25, C26, C36, C176, C180	22UF-16V-TANTBSMT	Kemet	T491B226M016AT	CAPACITOR TANT 22UF 16V 20% SMD
6	4	C17, C30, C37, C51	10uF, 25V-1206SMT	TDK Corporation	C3216Y5V1E106Z	CAP CER 10UF 25V Y5V 1206
7	4	C31, C32, C90, C93	1NF-0402SMT	TDK Corporation	C1005C0G1E102J	CAP CER 1000PF 25V COG 5% 0402
8	4	C38, C39, C52, C53	220NF-0402SMT	TDK Corporation	C1005X7R1C223K	CAP CER 22000PF 16V X7R 10% 0402
9	10	C40, C41, C42, C49, C50, C54, C55, C58, C63, C64	22uF, 6.3V-0805SMT	TDK Corporation	C2012X5R0J226M	CAP CER 22UF 6.3V X5R 20% 0805
10	4	C43, C44, C56, C57	1000pF-0402SMT	Panasonic	ECJ-0EB1E102K	CAP 1000PF 25V CERAMIC X7R 0402
11	4	C45, C48, C59, C62	330pF-0402SMT	TDK Corporation	C1005C0G1H331J	CAP CER 330PF 50V COG 5% 0402
12	2	C46, C47	10pF-0402SMT	TDK Corporation	C1005C0G1H100D	CAP CER 10PF 50V COG 0402
12A	0	C60, C61	10pF-0402SMT	DNI		
13	2	C65, C71	4_7UF-10V-SMT	TDK Corporation	C1608X5R1A475K	CAP CER 4.7UF 10V X5R 0603
14	1	C74	3_3UF-10V-SMT	TDK Corporation	C1608X5R1A335K	CAP CER 3.3UF 10V X5R 0603
15	2	C75, C76	DNI			
16	75	C78, C84, C95, C102, C104, C105, C107, C109, C110, C113, C115, C118, C119, C120, C121, C122, C124, C126, C128, C129, C130, C131, C133, C140, C142, C144, C145, C147, C148, C151, C153, C154, C155, C156, C157, C160, C162, C164, C166, C167, C168, C169, C172, C174, C175, C183, C185, C186, C188, C189, C191, C193, C195, C197, C199, C201, C205, C210, C212, C213, C214, C215, C216, C218, C220, C222, C224, C225, C227, C230, C231, C232, C233, C238, C240	100NF-0603SMT	Panasonic	ECJ-1VF1C104Z	CAP .1UF 16V CERAMIC Y5V 0603
17	2	C79, C80	12PF-0603SMT	TDK Corporation	C1608C0G1H120J	CAP CER 12PF 50V COG 5% 0603
18	2	C86, C87	100NFX5R-0402SMT	Kemet	C0402C104K8PACTU	CAP .10UF 10V CERAMIC X5R 0402
19	18	C94, C101, C103, C106, C114, C116, C117, C123, C125, C132, C139, C141, C143, C152, C158, C159, C161, C163	10uF/6V3/X7R-0805SMT	AVX	08056C106KAT2A	CAP CER 10UF 6.3V X7R 10% 0805
20	4	C111, C112, C149, C150	27pF-0603SMT	Kemet	C0603C270J5GACTU	CAP CERAMIC 27PF 50V NP0 0603

Table 12. LatticeECP3 Versa Evaluation Board Bill of Materials (Continued)

Item	Quantity	Reference	Part	Manufacturer	Part Number	Description
21	2	C127, C165	4_7UF-16V-0805SMT	TDK Corporation	C2012Y5V1C475Z/0.85	CAP CER 4.7UF 16V Y5V 0805
22	1	C170	47UF-16V-TANTBSMT	Kemet	B45196H2476K209	CAP TANTALUM 47UF 10V 10% SMD
23	1	C177	100UF-D3POSCAP	Sanyo	6TPE100MI	100UF, 6.3V , D2E. POSCAP
24	1	C179	10UF-16V-TANTBSMT	AVX	TAJB106K016R	CAP TANTALUM 10UF 16V 10% SMD
25	20	C182, C184, C187, C190, C192, C194, C196, C198, C200, C204, C209, C211, C217, C219, C221, C223, C226, C228, C234, C236	10NF-0603SMT	Kemet	C0603C103K5RACTU	CAP .01UF 50V CERAMIC X7R 0603
26	1	C229	6.8UF-TANT-0805SMT	Kemet	T494R685K006AS	CAP TANT 6.8UF 6.3V 10% SMD
27	1	C235	560PF-0603SMT	Kemet	C0603C561K5RACTU	CAP 560PF 50V CERAMIC X7R 0603
28	4	D1, D2, D5, D6	1N4448W	Fairchild	1N4448W	DIODE 75V 200MA SOD523F
29	4	D3, D4, D7, D8	DFLS220L	Diodes Inc	DFLS220L	DIODE SCHOTTKY 2A 20V PWRDI 123
30	12	D9, D10, D11, D12, D13, D15, D16, D20, D21, D22, D30, D31	LED_GREEN_0603	Kingbright	APT1608SGC	LED 1.6X0.8MM 568NM GRN CLR SMD
31	1	D14	SCHOTTKY/VISHAY-V12P10	Vishay	V12P10-M3/86A	DIODE SCHOTTKY 12A 100V SMPC TO-277A
32	5	D17, D18, D19, D26, D27	LED_RED_0603	Kingbright	APT1608EC	LED 1.6X0.8MM 625NM RED CLR SMD
33	1	D23	14-SEGMENT	Kingbright	ACPSA04-41SRWA	LED Display
34	2	D24, D25	LED_YELLOW_0603	Kingbright	APT1608YC	LED 1.6X0.8MM 588NM YLW CLR SMD
35	2	D28, D29	LED_BLUE_0603	Kingbright	APT1608QBC/D	LED 1.6X0.8 470NM BL WTR CLR SMD
36	6	FB1, FB2, FB3, FB4, FB21, FB22	BLM41PG600SN1	Murata	BLM41PG600SN1	FERRITE CHIP 60 OHM 6000MA 1806
37	5	FB5, FB6, FB23, FB24, FB25	MPZ1608Y600B	TDK	MPZ1608Y600B	FERRITE CHIP 60 OHM 2.3A 0603
38	14	FB7, FB8, FB9, FB10, FB11, FB12, FB13, FB14, FB15, FB16, FB17, FB18, FB19, FB20	Z-600 ohm / 74279265	Würth	74279265	FERRITE BEAD 600 OHM .2A 0603
39	1	F1	F1251CT-ND	Littlefuse	0154010.DR	FUSEBLOCK WITH 10A FUSE SMD
40	1	J1	PJ-032A	CUI	PJ-032A	CON PWR JCK 2.0 X 6.5MM VERT
41	1	J2	USB_MINI_AB	MOLEX	56579-0576	CONN RECEPT USB 5POS RT ANG SMD
42	2	J3, J14	HEADER 10	Samtec	TSW-110-07-T-S	10x1-0.25 Header
43	1	J4	HEADER 3X2	Samtec	TSW-103-07-T-D	3x2-0.25 Header
44	4	J5, J6, J7, J8	SMA	Molex	73391-0060	CONN JACK SMA STR 50 OHM PCB
45	1	J9	0826-1X2T-23-F	Bellfuse	0826-1X2T-23-F	CONN MAGJACK 2PORT GIGABIT GO/Y
46	2	J10, J12	HEADER 2	Samtec	TSW-102-07-T-S	2x1-0.25 Header
47	1	J13	HEADER 3(DNP)	DNI	TSW-103-07-T-S	3x1-0.25 Header
48	4	L1, L2, L3, L4	4.7uH-SPD62R-472M	API Delavan	SPD62R-472M	6.60mm x 6.20mm x 3.00mm, 4.7uH Power inductor
49	1	L5	1UH-1206SMT	Murata	LQM31PN1R0M00L	INDUCTOR 1.0UH 1.2A 1206
50	1	PP1	PROBEPOINT	DNI		
51	4	Q1, Q2, Q3, Q4	2N2222/SOT23	Diodes Inc	MMBT2222A-7	TRANS NPN 40V 350MW SMD SOT-23
52	2	Q5, Q6	BCP69-16	NXP Semiconductors	BCP69-16	TRANSISTOR PNP 20V 1A SOT223

Table 12. LatticeECP3 Versa Evaluation Board Bill of Materials (Continued)

Item	Quantity	Reference	Part	Manufacturer	Part Number	Description
53	5	RN1, RN2, RN3, RN4, RN5	741X083-100R	CTS	741X083101JP	RES ARRAY 100 OHM 8TERM 4RES SMD
54	2	RN6, RN8	EXB2HV151JV	Panasonic	EXB2HV151JV	RES ARRAY 150 OHM 5% 8 RES SMD
55	1	RN7	EXB2HV471JV	Panasonic	EXB2HV471JV	RES ARRAY 470 OHM 5% 8 RES SMD
56	1	RN9	EXB2HV472JV	Panasonic	EXB2HV472JV	RES ARRAY 4.7K OHM 5% 8 RES SMD
57	1	RP1	CTS-RT1402B7	CTS Corporation Resistor/Electrocomponents	RT2402B7	RES NET DDR SDRAM 50 OHM 3X9 BGA
58	14	R1, R2, R32, R33, R36, R38, R141, R145, R146, R169, R170, R175, R176, R177	0R-0603SMT	Panasonic	ERJ-3GEY0R00V	RES 0.0 OHM 1/10W 0603 SMD
59	7	R3, R4, R143, R144, R148, R149, R178	OPEN-0603SMT	DNI		
60	16	R5, R9, R21, R41, R42, R43, R54, R63, R64, R66, R67, R68, R69, R70, R71, R157	10K-0402SMT	Panasonic	ERJ-2RKF1002X	RES 10.0K OHM 1/10W 1% 0402 SMD
61	4	R6, R10, R12, R14	51K-0402SMT	Panasonic	ERJ-2RKF5102X	RES 51.0K OHM 1/10W 1% 0402 SMD
62	1	R7	21_5K-0402SMT	Panasonic	ERJ-2RKF2152X	RES 21.5K OHM 1/10W 1% 0402 SMD
63	1	R8	35_7K-0402SMT	Panasonic	ERJ-2RKF3572X	RES 35.7K OHM 1/10W 1% 0402 SMD
64	1	R11	34K-0402SMT	Panasonic	ERJ-2RKF3402X	RES 34.0K OHM 1/10W 1% 0402 SMD
65	1	R13	11_5K-0402SMT	Panasonic	ERJ-2RKF1152X	RES 11.5K OHM 1/10W 1% 0402 SMD
66	1	R15	5_11K-0402SMT	Panasonic	ERJ-2RKF5111X	RES 5.11K OHM 1/10W 1% 0402 SMD
67	1	R16	15K-0402SMT	Panasonic	ERJ-2RKF1502X	RES 15.0K OHM 1/10W 1% 0402 SMD
68	1	R17	16_9K-0402SMT	Panasonic	ERJ-2RKF1692X	RES 16.9K OHM 1/10W 1% 0402 SMD
69	1	R18	63_4K-0402SMT	Panasonic	ERJ-2RKF6342X	RES 63.4K OHM 1/10W 1% 0402 SMD
70	4	R22, R23, R24, R25	1_8K-1206SMT	Panasonic	ERJ-8ENF1801V	RES 1.80K OHM 1/4W 1% 1206 SMD
71	4	R26, R30, R31, R61, R179	220R-0603SMT	Panasonic	ERJ-3EKF2200V	RES 220 OHM 1/10W 1% 0603 SMD
72	5	R27, R28, R29, R37, R65	10K-0603SMT	Panasonic	ERJ-3EKF1002V	RES 10.0K OHM 1/10W 1% 0603 SMD
73	14	R34, R40, R51, R53, R100, R101, R103, R134, R135, R137, R162, R171, R172, R173	4_7K-0402SMT	Panasonic	ERJ-2RKF4701X	RES 4.70K OHM 1/10W 1% 0402 SMD
74	2	R35, R39	27R-0603SMT	Panasonic	ERJ-3EKF27R0V	RES 27.0 OHM 1/10W 1% 0603 SMD
75	1	R44	12K-0603SMT	Panasonic	ERJ-3EKF1202V	RES 12.0K OHM 1/10W 1% 0603 SMD
76	8	R45, R46, R47, R57, R58, R59, R72, R142	4_7K-0603SMT	Panasonic	ERJ-3EKF4701V	RES 4.70K OHM 1/10W 1% 0603 SMD
77	1	R48	2_2K-0603SMT	Panasonic	ERJ-3EKF2201V	RES 2.20K OHM 1/10W 1% 0603 SMD
78	2	R49, R174	1K-0603SMT	Panasonic	ERJ-3EKF1001V	RES 1.00K OHM 1/10W 1% 0603 SMD
79	1	R50	1M-0603SMT	Panasonic	ERJ-3EKF1004V	RES 1.00M OHM 1/10W 1% 0603 SMD
80	3	R55, R56, R60	680R-0603SMT	Panasonic	ERJ-3EKF6800V	RES 680 OHM 1/10W 1% 0603 SMD
81	1	R62	OPEN-0402SMT	DNI		
82	5	R73, R74, R107, R108, R156	100R-0402SMT	Panasonic	ERJ-2RKF1000X	RES 100 OHM 1/10W 1% 0402 SMD

Table 12. LatticeECP3 Versa Evaluation Board Bill of Materials (Continued)

Item	Quantity	Reference	Part	Manufacturer	Part Number	Description
83	47	R52, R75, R76, R77, R78, R79, R80, R81, R82, R84, R85, R86, R87, R88, R89, R90, R91, R93, R94, R95, R96, R97, R98, R99, R104, R109, R110, R111, R112, R113, R114, R115, R116, R117, R118, R120, R121, R122, R123, R124, R125, R126, R127, R129, R130, R131, R160	0R-0402SMT	Panasonic	ERJ-2GE0R00X	RES 0.0 OHM 1/10W 0402 SMD
84	4	R83, R92, R119, R128	20R-0402SMT	Vishay	CRCW040220R0FKED	RES 20.0 OHM 1/16W 1% 0402 SMD
85	2	R102, R136	1K-0402SMT	Panasonic	ERJ-2RKF1001X	RES 1.00K OHM 1/10W 1% 0402 SMD
86	2	R105, R139	4_99K-0402SMT	Panasonic	ERJ-2RKF4991X	RES 4.99K OHM 1/10W 1% 0402 SMD
87	2	R106, R140	4_75K-0603SMT	Panasonic	ERJ-3EKF4751V	RES 4.75K OHM 1/10W 1% 0603 SMD
88	3	R132, R133, R138	33R-0402SMT	Panasonic	ERJ-2RKF33R0X	RES 33.0 OHM 1/10W 1% 0402 SMD
89	1	R147	240R-0603SMT	Panasonic	ERJ-3EKF2400V	RES 240 OHM 1/10W 1% 0603 SMD
90	6	R150, R151, R152, R153, R154, R155	50R-0402SMT	Vishay	FC0402E50R0FST1	RES 50 OHM 50MW +/-1% 0402 SMD
91	5	R158, R161, R164, R165, R168	10R-0402SMT	Panasonic	ERJ-2RKF2200X	RES 200 OHM 1/10W 1% 0402 SMD
92	2	R159, R166	220R-0402SMT	Panasonic	ERJ-2RKF10R0X	RES 10.0 OHM 1/10W 1% 0402 SMD
93	1	R163	680R-0402SMT	Panasonic	ERJ-2RKF6800X	RES 680 OHM 1/10W 1% 0402 SMD
94	1	R167	470R-0402SMT	Panasonic	ERJ-2RKF4700X	RES 470 OHM 1/10W 1% 0402 SMD
95	2	SW1, SW2	PHP03T	Panasonic	EVQ-Q2K03W	SPST SMD
96	1	SW3	TDA DIP-8	C&K	TDA08H0SB1	8-DIP
97	14	TP1, TP2, TP3, TP4, TP5, TP6, TP7, TP8, TP9, TP10, TP11, TP12, TP13, TP14	TestPoint	DNI		
98	1	U1	LFE3-35E-FN484CES	Lattice-supplied	Lattice Semiconductor	
99	1	U2	LT3029EDE	Lattice-supplied	Linear Tech	
100	2	U3, U4	LT3508EUF	Lattice-supplied	Linear Tech	
101	1	U5	FT2232HL	FTDI	FTD2232H	USB-UART/JTAG
102	1	U6	93LC56-SO8	MicroChip	93LC56/SN	IC EEPROM 2KBIT 2MHZ 8SOIC
103	1	U7	MAX6817	Maxim	MAX6817-EUT+T	debounce
104	1	U8	M25P64-FLASH	STMicro	M25P64-VMF6TP	Serial Flash
105	2	U9, U10	88E1119R_72QFN	Lattice-supplied	Marvell-88E1119R	GPHY
106	1	U11	ddr3-96bga	Micron	MT41J64M16JT-15E:G	64Mb/x16, 1.5V, 96-ball FBGA, 667 MHz, DDR3-1333
107	1	U12	LP2998-SO8	National Semiconductor	LP2998MAX/NOPB	Termination regulator
108	1	U13	ispCLOCK5406D	Lattice-supplied	Lattice Semiconductor	
109	1	X1	DSC-100_00MHz	Lattice-supplied/ Discera	DSC1123AE2-100.0000	100MHz Low-Jitter LVDS Clock Oscillator, 7mm x 5mm, 50ppm
110	1	X2	156.25MHz	Lattice-supplied/ Discera	DSC1121AI1-156.2500	156.25MHz Single ended CMOS Clock Oscillator, 7mm x 5mm
111	2	EX3, EX4	HDR40	Samtec	TSW-120-07-T-D	HEADER 40POS .100" DL TIN
112	1	Y1	ATS120SM-1 HC-49/US-SM	CTS	ATS120SM-T	CRYSTAL 12.0000MHZ 20PF SMD
113	2	Y2, Y3	25MHZ CRYSTAL	Citizen	HC49US-25.000MABJ-UB	CRYSTAL 25.000 MHZ 18PF HC49/US

Table 12. LatticeECP3 Versa Evaluation Board Bill of Materials (Continued)

Item	Quantity	Reference	Part	Manufacturer	Part Number	Description
114	1	R19	30_1K-0402SMT	Panasonic	ERJ-2RKF3012X	RES 30.1K OHM 1/10W 1% 0402 SMD
115	1	R20	20K-0402SMT	Panasonic	ERJ-2RKF2002X	RES 20.0K OHM 1/10W 1% 0402 SMD
115	2	C245, C246	100PF-0402SMT	Panasonic	ECJ-0EB1E102K	CAP 100PF 25V CERAMIC X7R 0402
116	2	C10, C12	3_3UF-10V-0805SMT	Panasonic	ECJ-2FB1A335K	CAP 3.3UF 10V CERAMIC X5R 0805