

# Future Technology Devices International Ltd UMFT60x (FIFO TO USB 3.0 Bridge Evaluation Board)



The UMFT60xx is an evaluation/development module with either FMC(LPC)/HSMC connectors for interfacing FTDI's FT60x USB 3.0 Superspeed IC with external hardware. The UMFT60xx allows for bridging a FIFO bus to a USB3.0 host and evaluating the functionality of the FT60x.

As a daughter card, the UMFT60xx must work with a FIFO master board which has either a FMC or HSMC connector. There are 4 models which provide different FIFO bus interfaces and data bit widths.

The modules are designed such that they can plug into most FPGA development platforms supplied by vendors such as Xilinx or Altera.

Refer to [Ordering Information](#) for module options.

The UMFT60xx supports 2 parallel slave FIFO bus protocols (Multi-Channel FIFO / 245 Synchronous FIFO) with a data "burst" rate of up to 400MB/s. For a full list of the FT60x's features refer to the [FT60x datasheet](#).

The UMFT60xx module has the following features:

- Supports USB 3.0 Super Speed (5Gbps)/USB 2.0 High Speed (480Mbps)/USB 2.0 Full Speed (12Mbps) transfer
- 4 IN channels and 4 OUT channels on FIFO bus connectivity
- Supports multi voltage I/O: 1.8V, 2.5V and 3.3V
- High speed connector for FIFO bus : FMC(Field Programmable Mezzanine Card) or HSMC (High Speed Mezzanine Card)
- FMC connector is compatible with most Xilinx FPGA reference design boards
- HSMC is compatible with most Altera FPGA reference design boards
- Multi powered options: external DC powered, BUS powered, FMC/HSMC powered
- Hardware Reset and Remote Wake Up
- Micro-USB3.0 receptacle

## 1 Ordering Information

<b>Part No.</b>	<b>Description</b>
UMFT600A	16 Bit FIFO bus, HSMC connector
UMFT601A	32 Bit FIFO bus, HSMC connector
UMFT600X	16 Bit FIFO bus, FMC (Low Pin Count)connector
UMFT601X	32 Bit FIFO bus, FMC(Low Pin Count) connector

**Table 1.1 UMFT60xx Ordering Information**

## Table of Contents

<b>1</b>	<b>Ordering Information .....</b>	<b>1</b>
<b>2</b>	<b>Hardware Description.....</b>	<b>3</b>
<b>2.1</b>	<b>Physical Description.....</b>	<b>5</b>
2.1.1	Dimensions.....	5
<b>2.2</b>	<b>Connectors, Jumpers and Push Buttons .....</b>	<b>7</b>
2.2.1	CN1 - Micro USB3.0 Receptacle .....	7
2.2.2	CN2 – POWER JACK 2.1MM.....	7
2.2.3	JP1 – External/VBUS Powered Selection .....	7
2.2.4	JP2 – VCC33 Selection .....	8
2.2.5	JP3, JP6– VCCIO Selection .....	8
2.2.6	JP4, JP5 –FIFO mode selection and GPIO pin out .....	8
2.2.7	SW1, SW2 – Push Buttons for Reset and Remote Wake Up .....	8
2.2.8	CN4 – FMC / HSMC FIFO bus interface connector.....	9
<b>3</b>	<b>Board Schematics.....</b>	<b>13</b>
<b>4</b>	<b>Hardware Setup Guide.....</b>	<b>18</b>
<b>4.1</b>	<b>Power Configuration .....</b>	<b>18</b>
<b>4.2</b>	<b>Jumpers Default Position .....</b>	<b>18</b>
<b>4.3</b>	<b>Power Consumption .....</b>	<b>19</b>
<b>5</b>	<b>Contact Information .....</b>	<b>20</b>
<b>Appendix A – References .....</b>		<b>21</b>
Document References .....		21
Acronyms and Abbreviations.....		21
<b>Appendix B – List of Tables &amp; Figures.....</b>		<b>22</b>
List of Tables.....		22
List of Figures .....		22
<b>Appendix C – Revision History .....</b>		<b>23</b>

## 2 Hardware Description

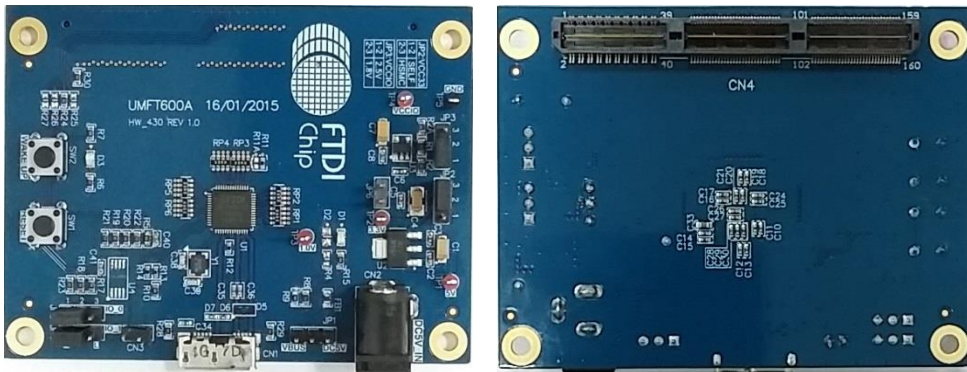


Figure 2-1 UMFT600A Module Top and Bottom View

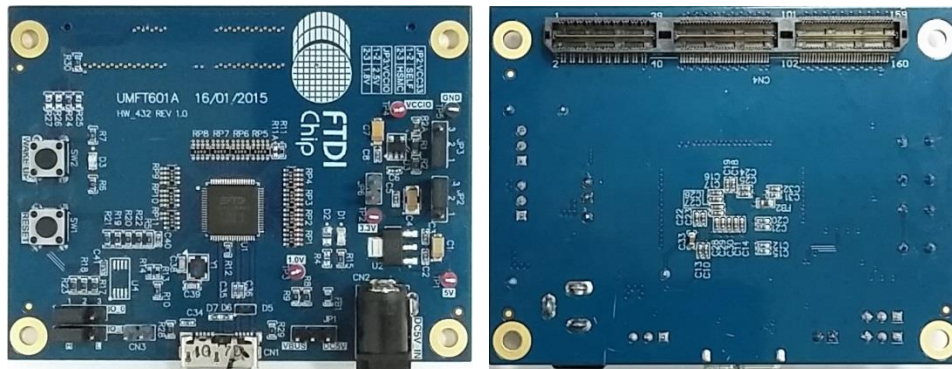


Figure 2-2 UMFT601A Module Top and Bottom View

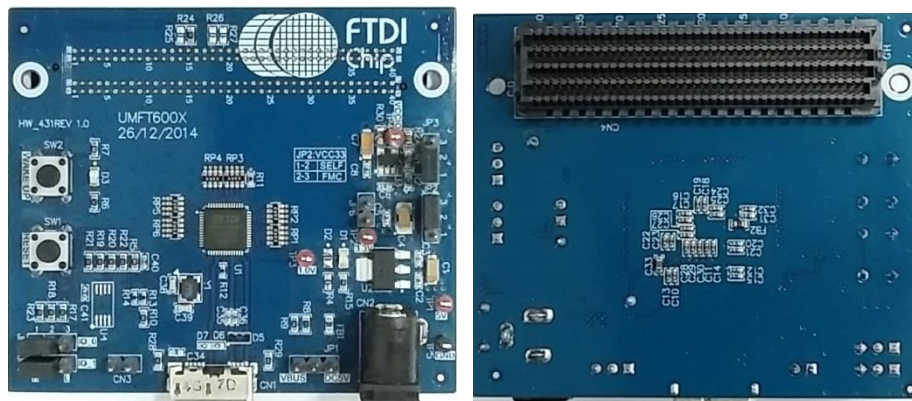
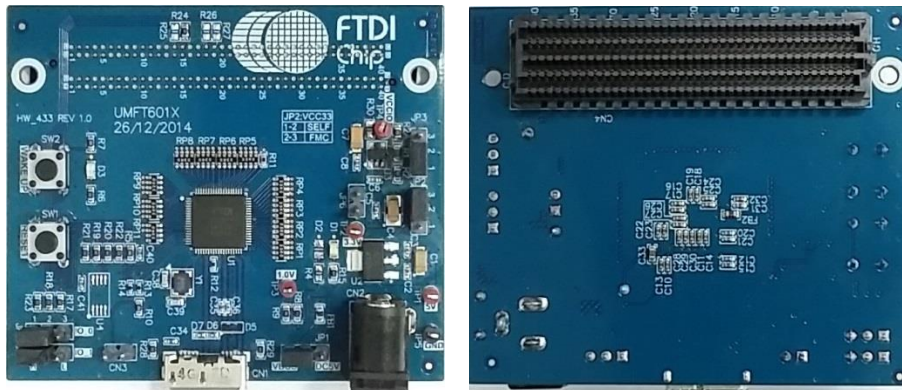


Figure 2-3 UMFT600X Module Top and Bottom View



**Figure 2-4 UMFT601X Module Top and Bottom View**

The main functions of the UMFT60xx module are as follows:

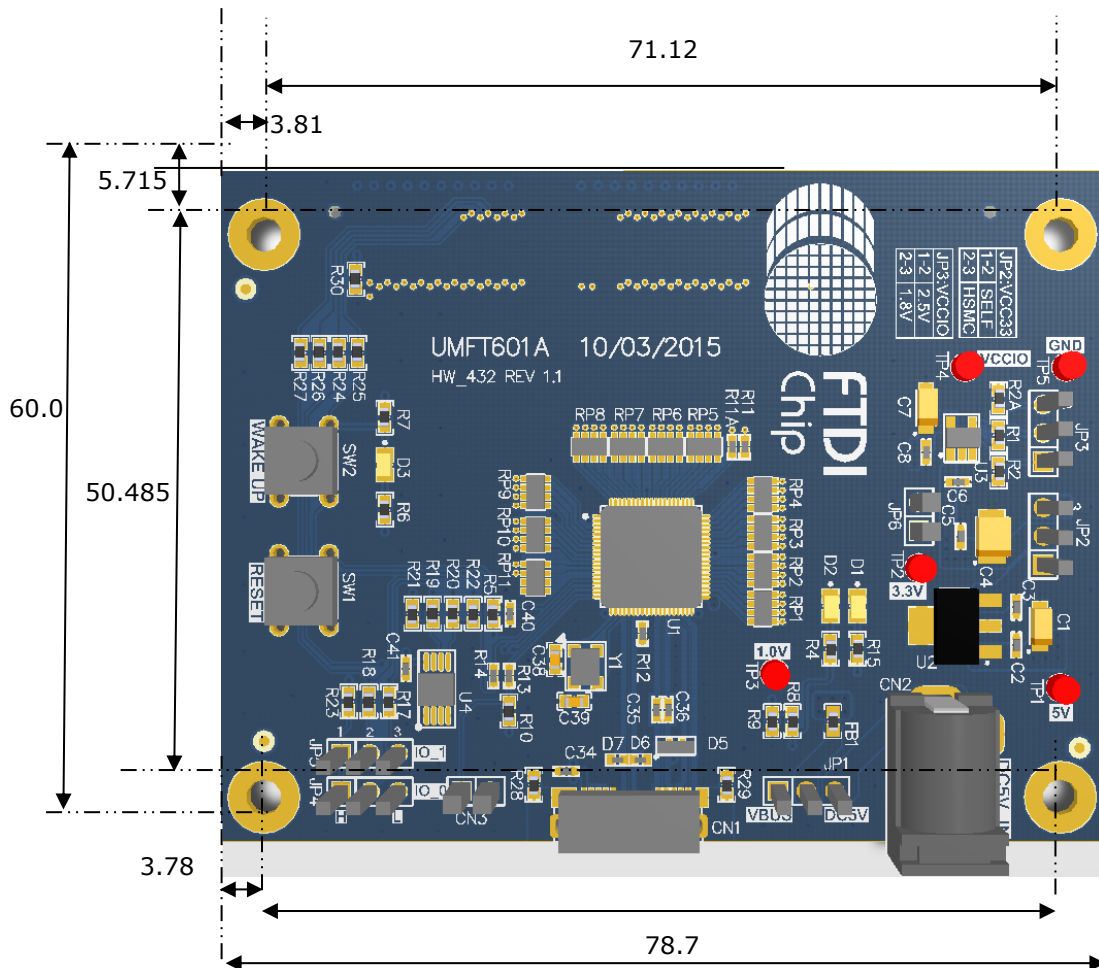
- Provides Multi-channel FIFO mode and 245 Synchronous FIFO mode Protocols, configured by GPIOs.
- Configurable FIFO clock: 66.67MHz and 100MHz (100MHz only for 2.5V or 3.3V VCCIO), default clock is 100MHz.
- High speed FIFO bus interface: FMC (Low Pin Count) and HSMC optional. See [Ordering Information](#).
- Jumpers selection allowing powered options: VBUS-powered, External DC-powered, FIFO master board-powered.
- Multi voltage VCCIO option: 1.8V, 2.5V, 3.3V.
- Configurable GPIOs.
- Hardware reset and remote wake up support.
- Available with 16bit and 32bit wide FIFO bus.



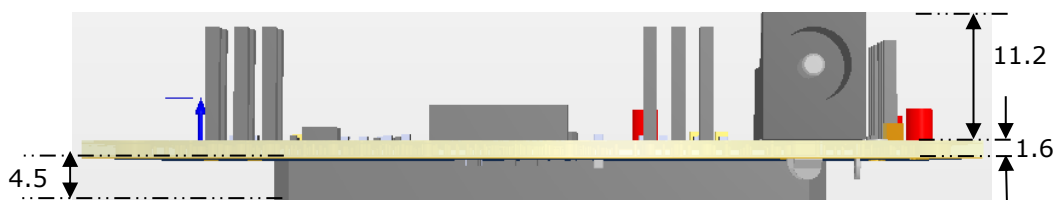
## 2.1 Physical Description

The UMFT600A/UMFT601A and UMFT600X/UMFT601X modules dimensions are illustrated in Figure 2.5 to Figure 2.8.

### 2.1.1 Dimensions

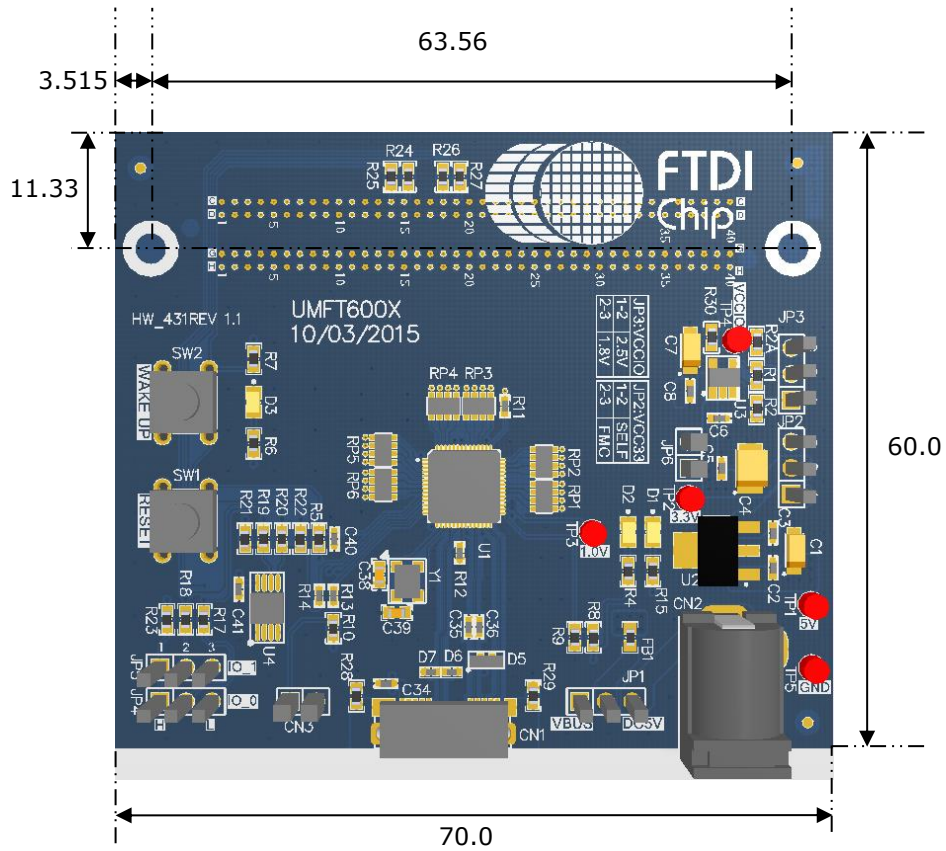


**Figure 2-5 UMFT600A/UMFT601A Dimensions (Top view)**

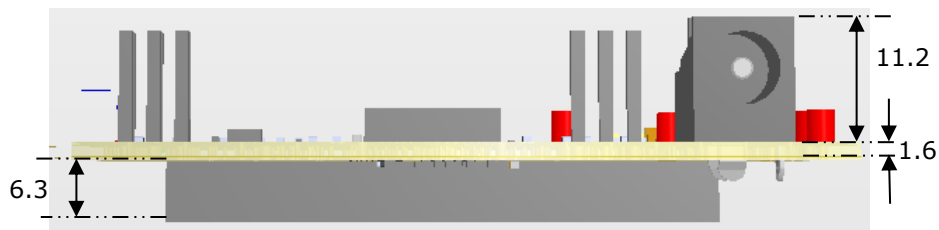


**Figure 2-6 UMFT600A/UMFT601A Dimensions (Side view)**

±0.10mm Tolerance  
All dimensions are in mm



**Figure 2-7 UMFT600X/UMFT601X Dimensions (Top view)**



**Figure 2-8 UMFT600X/UMFT601X Dimensions (Side view)**

±0.10mm Tolerance  
All dimensions are in mm

## 2.2 Connectors, Jumpers and Push Buttons

Connectors, jumpers and push buttons are described in the following sections.

### 2.2.1 CN1 - Micro USB3.0 Receptacle

Pin No.	Name	Type	Description
1	VBUS	P	5V DC power supply
2	D-	IO	USB D- line
3	D+	IO	USB D+ line
4	ID	IO	OTG identification(N.C.)
5	GND	P	Ground
6	SSTX-	O	Super Speed USB transmitter differential pair (-)
7	SSTX+	O	Super Speed USB transmitter differential pair(+)
8	GND	P	Ground
9	SSRX-	I	Super Speed USB receiver differential pair (-)
10	SSRX+	I	Super Speed USB receiver differential pair (+)

**Table 2.1 CN1 - Micro USB3.0 Pin-out**

### 2.2.2 CN2 – POWER JACK 2.1MM

Optional external DC 5V input.

Pin No.	Name	Type	Description
1	5V	P	5V power supply
2	GND	P	Ground
3	GND	P	Ground

**Table 2.2 CN2 – POWER JACK 2.1MM**

### 2.2.3 JP1 – External/VBUS Powered Selection

Select whether the module power is supplied by an external DC 5V or VBUS. Note this setting must be chosen in conjunction with the JP2 setting. Default is open <sup>[Note]</sup>

Jumper position	Description
Short pin 1-2	Select VBUS Power
Short pin 2-3	Select external DV 5V

**Table 2.3 JP1 – 5V input Options**



### 2.2.4 JP2 – VCC33 Selection

Select whether the module main power is supplied by DC5V or the FIFO master board DC3.3V.<sup>[Note]</sup>

Jumper position	Description
Short pin 1-2	Select powered by external DV5V or VBUS
Short pin 2-3	Select powered by FIFO master Board(default)

**Table 2.4 JP3 – VCC33 Option**

### 2.2.5 JP3, JP6– VCCIO Selection

Select the IO voltage level.<sup>[Note]</sup>

Jumper position		Description
JP3	JP6	
Short pin 1-2	Open	VCCIO=2.5V(default)
Short pin 2-3	Open	VCCIO=1.8V
Open	Short	VCCIO=3.3V

**Table 2.5 JP3 – VCCIO Option**

### 2.2.6 JP4, JP5 –FIFO mode selection and GPIO pin out

Select Multi-channel FIFO mode or 245 Synchronous FIFO mode.

JP4 pin2 is GPIO\_0 pin out and JP5 pin2 is GPIO\_1 pin out.

Jumper position		FIFO Mode	Channel No.	GPIO valid	
JP4	JP5			GPIO_0 (JP4 pin2)	GPIO_1 (JP5 pin2)
1-2(or open)	1-2(or open)	Multi-Channel FIFO	4	Yes	Yes
1-2(or open)	2-3	Multi-Channel FIFO	2	Yes	No
2-3	1-2(or open)	Multi-Channel FIFO	1	No	Yes
2-3	2-3	245 Synchronous FIFO	1	No	No

**Table 2.6 JP4, JP5 – Configurations**

**Note:** Please refer to section [4 Hardware setup guide](#) for more details power configuration options and jumpers positions.

### 2.2.7 SW1, SW2 – Push Buttons for Reset and Remote Wake Up

SW1 – Reset, module hardware reset, mapped to FMC/HSMC connector, can be used for FIFO master reset. Drive low when press down.

SW2 – Remote Wake Up, drive low when press down.

**2.2.8 CN4 – FMC / HSMC FIFO bus interface connector.**

**2.2.8.1 FMC connector configurations-UMFT600X/UMFT601X Module**

<b>FMC Pin#/Name</b>	<b>UMFT600X U1: FT600 Pin#/Name</b>	<b>UMFT601X U1: FT601 Pin#/Name</b>
C14/LA10_P	11 /Wake up_N (Optional, default: OPEN)	16 /Wake up_N (Optional, default: OPEN)
C15/LA10_N	10 /RESET_N	15 /RESET_N
C18/LA14_P	12 /GPIO_0(Optional, default: OPEN)	17 /GPIO_0(Optional, default: OPEN)
C19/LA14_N	13 /GPIO_1(Optional, default: OPEN)	18 /GPIO_1(Optional, default: OPEN)
C22/LA18_P_CC	43 /D_CLK (FIFO bus clock,FT600 output)	68 /D_CLK (FIFO bus clock,FT601 output)
C26/LA27_P	N.C.	62 /DATA18
C27_LA27_N	N.C.	60 /DATA16
D14/LA09_P	N.C.	8 /BE_N_3
D15/LA09_N	N.C.	7 /BE_N_2
D20/LA17_P_CC	N.C.	76 /DATA31
D21/LA17_N_CC	N.C.	75 /DATA30
D23/LA23_P	N.C.	70 /DATA25
D24/LA23_N	N.C.	69 /DATA24
D26/LA26_P	N.C.	63 /DATA19
D27/LA26_N	N.C.	61 /DATA17
G6/LA00_P_CC	N.C.	13 /OE_N
G7/LA00_N_CC	N.C.	12 /RD_N
G12/LA08_P	N.C.	11 /WR_N
G13/LA08_N	N.C.	10 /SIWU_N
G21/LA20_P	9 /OE_N	74 /DATA29
G22/LA20_N	8 /RD_N	73 /DATA28
G24/LA22_P	7 /WR_N	67 /DATA23
G25/_LA22_N	6 /SIWU_N	65 /DATA21
G27/LA25_P	56 /DATA15	57 /DATA15
G28/LA25_N	54 /DATA13	55 /DATA13

<b>FMC Pin#/Name</b>	<b>UMFT600X U1: FT600 Pin#/Name</b>	<b>UMFT601X U1: FT601 Pin#/Name</b>
G30/LA29_P	48 /DATA11	53 /DATA11
G31/LA29_N	46 /DATA9	51 /DATA9
G33/LA31_P	42 /DATA7	47 /DATA7
G34/LA31_N	40 /DATA5	45 /DATA5
G36/LA33_P	36 /DATA3	43 /DATA3
G37/LA33_N	34 /DATA1	41 /DATA1
H13/LA07_P	N.C.	9 /RXF_N
H14/LA07_N	N.C.	8 /TXE_N
H19/LA15_P	N.C.	5 /BE_N_1
H20/LA15_N	N.C.	4 /BE_N_0
H22/LA19_P	5 /RXF_N	72 /DATA27
H23/LA19_N	4 /TXE_N	71 /DATA26
H25/LA21_P	3 /BE_N_1	66 /DATA22
H26/LA21_N	2 /BE_N_0	64 /DATA20
H28/LA24_P	55 /DATA14	56 /DATA14
H29/LA24_N	53 /DATA12	54 /DATA12
H31/LA28_P	47 /DATA10	52 /DATA10
H32/LA28_N	45 /DATA8	50 /DATA8
H34/LA30_P	41 /DATA6	46 /DATA6
H35/LA30_N	39 /DATA4	44 /DATA4
H37/LA32_P	35 /DATA2	42 /DATA2
H38/LA32_N	33 /DATA0	40 /DATA0

**Table 2.7 CN4 – FMC connector configuration for FIFO bus**

**2.2.8.2 CN4 – HSMC connector configurations-UMFT600A/UMFT601A Module**

<b>HSMC Pin#/Name</b>	<b>UMFT600A U1: FT600 Pin#/Name</b>	<b>UMFT601A U1: FT601 Pin#/Name</b>
40 /CLKIN0	43 /D_CLK (FIFO bus clock,FT600 output)	68 /D_CLK (FIFO bus clock,FT601 output)

<b>HSMC Pin#/Name</b>	<b>UMFT600A U1: FT600 Pin#/Name</b>	<b>UMFT601A U1: FT601 Pin#/Name</b>
41 /D0	33 /DATA0	40 /DATA0
42 /D1	45 /DATA8	60 /DATA16
43 /D2	34 /DATA1	41 /DATA1
44 /D3	46 /DATA9	61 /DATA17
47 /D4	35 /DATA2	42 /DATA2
48 /D5	47 /DATA10	62 /DATA18
49 /D6	36 /DATA3	43 /DATA3
50 /D7	48 /DATA11	63 /DATA19
53 /D8	39 /DATA4	44 /DATA4
54 /D9	53 /DATA12	64 /DATA20
55 /D10	40 /DATA5	45 /DATA5
56 /D11	54 /DATA13	65 /DATA21
59 /D12	41 /DATA6	46 /DATA6
60 /D13	55 /DATA14	66 /DATA22
61 /D14	42 /DATA7	47 /DATA7
62 /D15	56 /DATA15	67 /DATA23
65 /D16	N.C.	50 /DATA8
66 /D17	2 /BE_N_0	69 /DATA24
67 /D18	N.C.	51 /DATA9
68 /D19	3 /BE_N_1	70 /DATA25
71 /D20	N.C.	52 /DATA10
72 /D21	4 /TXE_N	71 /DATA26
73 /D22	N.C.	53 /DATA11
74 /D23	5 /RXF_N	72 /DATA27
77 /D24	13 /GPIO_1(Optional, default: OPEN)	54 /DATA12
78 /D25	6 /SIWU_N	73 /DATA28
79 /D26	12 /GPIO_0(Optional, default: OPEN)	55 /DATA13
80 /D27	7 /WR_N	74 /DATA29

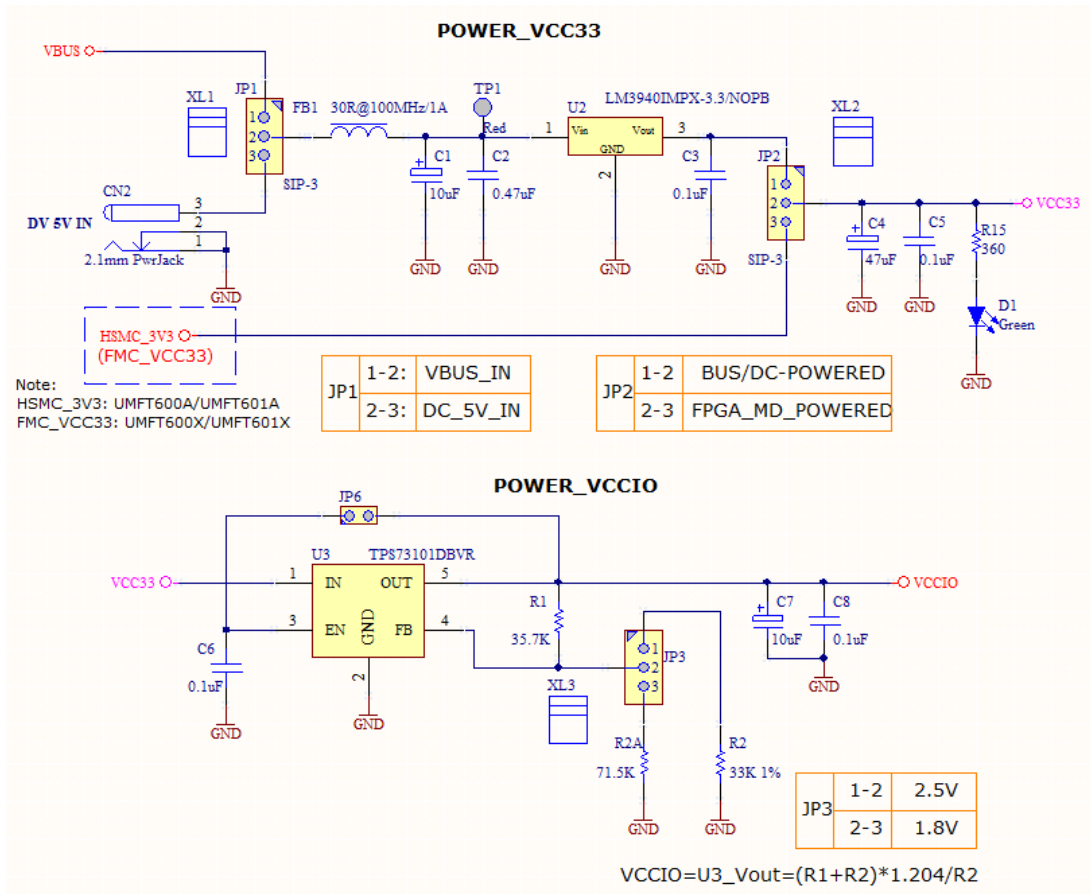
<b>HSMC Pin#/Name</b>	<b>UMFT600A U1: FT600 Pin#/Name</b>	<b>UMFT601A U1: FT601 Pin#/Name</b>
83 /D28	10 /RESET_N	56 /DATA14
84 /D29	8 /RD_N	75 /DATA30
85 /D30	11 /Wake up_N (Optional, default: OPEN)	57 /DATA15
86 /D31	9 /OE_N	76 /DATA31
101 /D40	N.C.	4 /BE_N_0
102 /D41	N.C.	8 /TXE_N
103 /D42	N.C.	5 /BE_N_1
104 /D43	N.C.	9 /RXF_N
107 /D44	N.C.	7 /BE_N_2
108 /D45	N.C.	10 /SIWU_N
109 /D46	N.C.	8 /BE_N_3
110 /D47	N.C.	11 /WR_N
113 /D48	N.C.	18 /GPIO_1(Optional, default: OPEN)
114 /D49	N.C.	12 /RD_N
115 /D50	N.C.	17 /GPIO_0(Optional, default: OPEN)
116 /D51	N.C.	13 /OE_N
119 /D52	N.C.	15 /RESET_N
121 /D54	N.C.	16 /Wake up_N (Optional, default: OPEN)

**Table 2.8 CN4 – HSMC connector configuration for FIFO bus**

**Note:** Refer to the [FT600/FT601 device datasheet](#) section 3 for details of the device pin out and signal descriptions.



### 3 Board Schematics



**Figure 3-1 Schematics: Power for UMFT600A/UMFT600X/UMFT601A/UMFT601X**

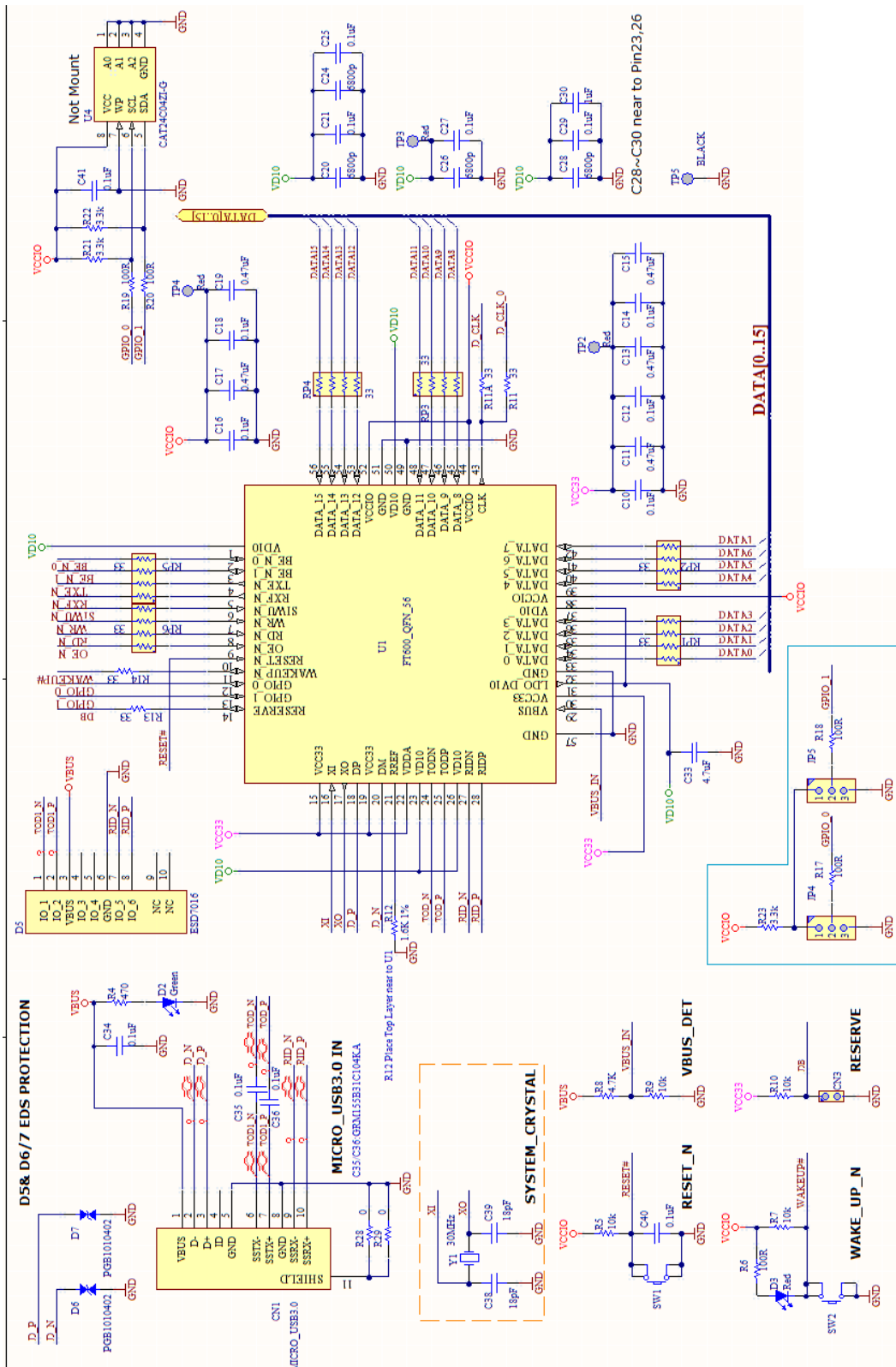


Figure 3-2 Schematics: USB3.0 Bridge\_UMFT600A/UMFT600X

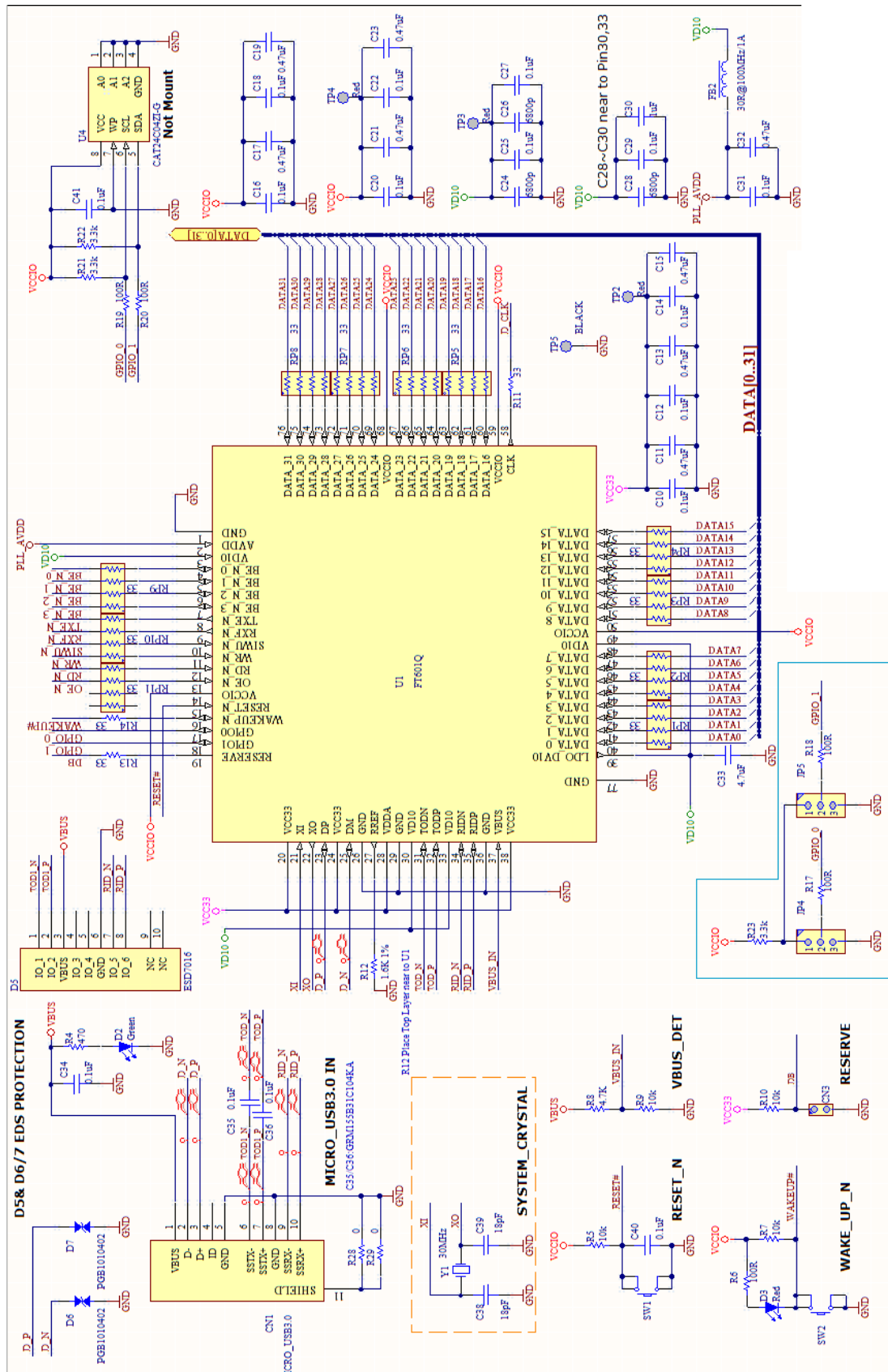


Figure 3-3 Schematics: USB3.0 Bridge\_UMFT601A/UMFT601X

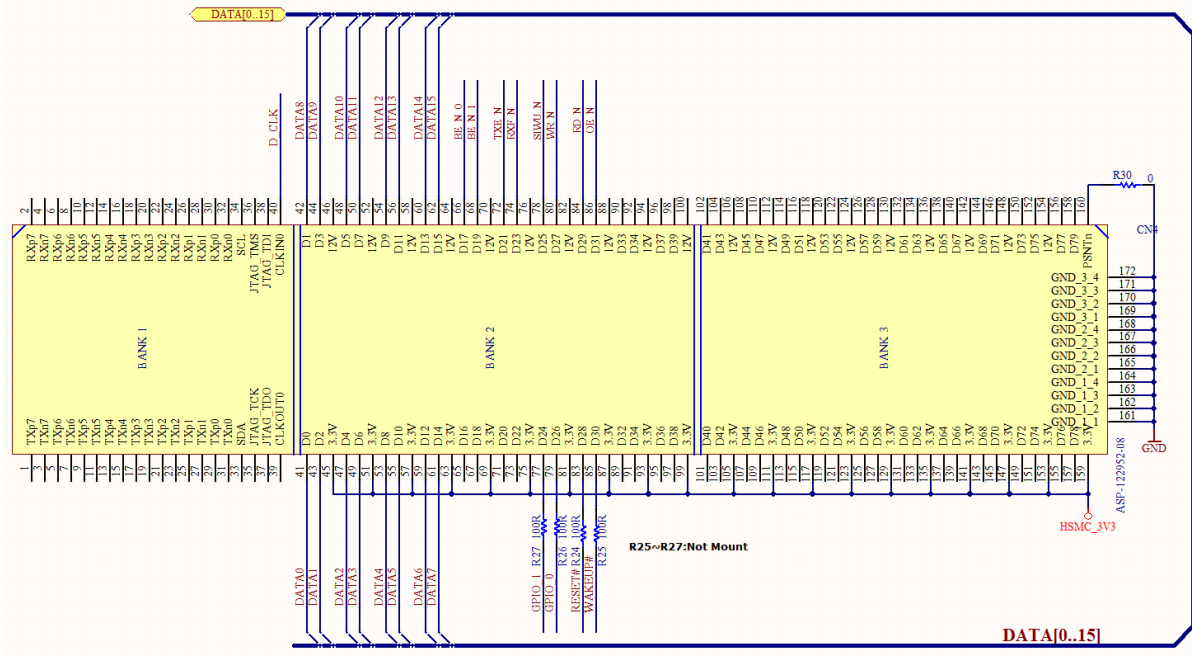


Figure 3-4 Schematics: HSMC\_UMFT600A

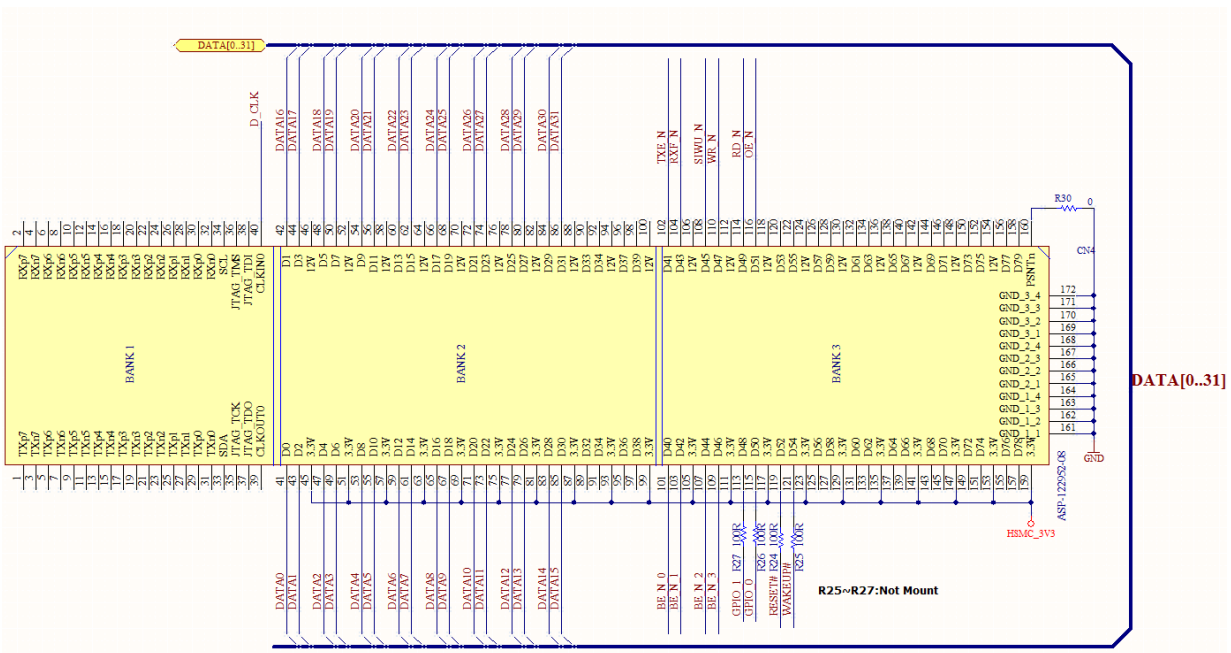
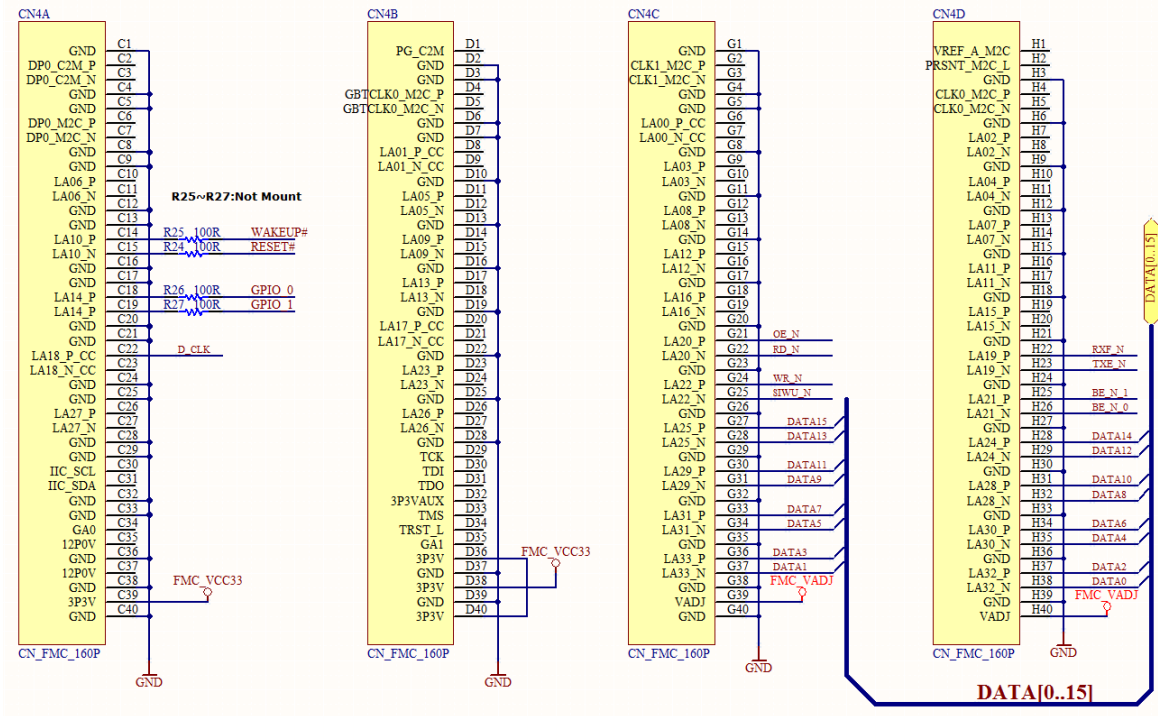
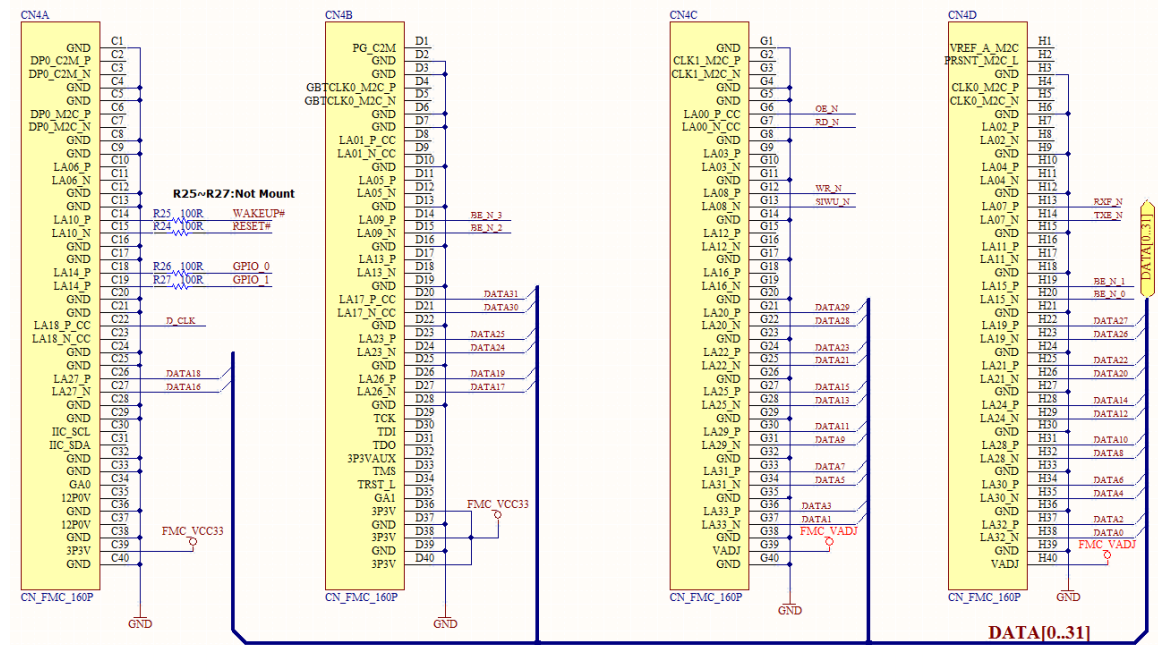


Figure 3-5 Schematics: HSMC\_UMFT601A



**Figure 3-6 Schematics: FMC\_UMFT600X**



**Figure 3-7 Schematics: FMC\_UMFT601X**



## 4 Hardware Setup Guide

### 4.1 Power Configuration

There are 3 methods of powering the UMFT60xx module.

- 1) FIFO master board Power (3.3V)-Connect the UMFT60xx board to the FIFO master board that has the standard configuration FMC (LPC or HPC) or HSMC female connector. This method is the default setting and recommended.
- 2) USB Power (5V) - Connect USB power by micro-USB3.0 or micro-USB2.0 cable to CN1.
- 3) DC IN (5V) - Connect DC 5V to CN2.

The following table summarizes how to power the UMFT60xx module using the various methods.

Power Method	CN1	CN2	JP1	JP2	JP3 and JP6
FIFO master board Power(Default and Recommended)	-	N.C.	Open	Short pin 2-3	Follow FIFO master IO voltage. Default: JP3 short pin1-2 VCCIO=2.5V JP6: Open
USB Power	5V	N.C.	Short pin1-2	Short pin1-2	
DC IN(5V)	-	5V	Short pin2-3	Short pin1-2	

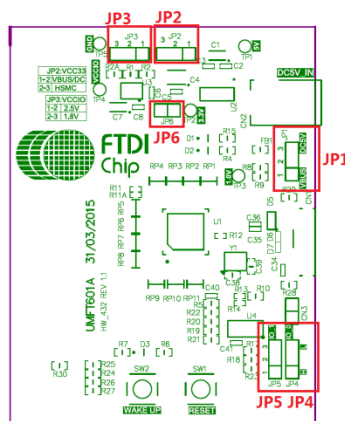
**Table 4.1 Board Power Configuration**

### 4.2 Jumpers Default Position

Jumper	JP1	JP2	JP3	JP4	JP5	JP6
Default Position	Open	2-3	1-2	1-2	1-2	Open

**Table 4.2 Jumpers Default Position**

Figure 4.1 shows the Jumpers' locations on the PCB, and they are the same location on all 4 modules.



**Figure 4-1 Jumpers Locations**

### 4.3 Power Consumption

Parameter	Description	Minimum	Typical	Maximum	Units	Conditions
I <sub>VCC 1</sub>	VCC Operating Supply Current	-	190	-	mA	Function Mode
I <sub>VCC 2</sub>	VCC Operating Supply Current	-	7.0	-	mA	Suspend Mode
I <sub>VBUS1</sub>	VBUS Operating Current	-	0.34	-	mA	DC/HSMC/FMC Powered, Function and Suspend Mode
I <sub>VBUS2</sub>	VBUS Operating Current	-	191	-	mA	VBUS-Powered Powered, Function Mode
I <sub>VBUS3</sub>	VBUS Operating Current	-	7.3	-	mA	VBUS-Powered Powered, Suspend Mode

**Table 4.3 Power Consumption**

## 5 Contact Information

### Head Office – Glasgow, UK

Future Technology Devices International Limited  
Unit 1, 2 Seaward Place, Centurion Business Park  
Glasgow G41 1HH  
United Kingdom  
Tel: +44 (0) 141 429 2777  
Fax: +44 (0) 141 429 2758

E-mail (Sales) [sales1@ftdichip.com](mailto:sales1@ftdichip.com)  
E-mail (Support) [support1@ftdichip.com](mailto:support1@ftdichip.com)  
E-mail (General Enquiries) [admin1@ftdichip.com](mailto:admin1@ftdichip.com)

### Branch Office – Tigard, Oregon, USA

Future Technology Devices International Limited  
(USA)  
7130 SW Fir Loop  
Tigard, OR 97223-8160  
USA  
Tel: +1 (503) 547 0988  
Fax: +1 (503) 547 0987

E-Mail (Sales) [us.sales@ftdichip.com](mailto:us.sales@ftdichip.com)  
E-Mail (Support) [us.support@ftdichip.com](mailto:us.support@ftdichip.com)  
E-Mail (General Enquiries) [us.admin@ftdichip.com](mailto:us.admin@ftdichip.com)

### Branch Office – Taipei, Taiwan

Future Technology Devices International Limited  
(Taiwan)  
2F, No. 516, Sec. 1, NeiHu Road  
Taipei 114  
Taiwan, R.O.C.  
Tel: +886 (0) 2 8791 3570  
Fax: +886 (0) 2 8791 3576

E-mail (Sales) [tw.sales1@ftdichip.com](mailto:tw.sales1@ftdichip.com)  
E-mail (Support) [tw.support1@ftdichip.com](mailto:tw.support1@ftdichip.com)  
E-mail (General Enquiries) [tw.admin1@ftdichip.com](mailto:tw.admin1@ftdichip.com)

### Branch Office – Shanghai, China

Future Technology Devices International Limited  
(China)  
Room 1103, No. 666 West Huaihai Road,  
Shanghai, 200052  
China  
Tel: +86 21 62351596  
Fax: +86 21 62351595

E-mail (Sales) [cn.sales@ftdichip.com](mailto:cn.sales@ftdichip.com)  
E-mail (Support) [cn.support@ftdichip.com](mailto:cn.support@ftdichip.com)  
E-mail (General Enquiries) [cn.admin@ftdichip.com](mailto:cn.admin@ftdichip.com)

### Web Site

<http://ftdichip.com>

### Distributor and Sales Representatives

Please visit the Sales Network page of the [FTDI Web site](#) for the contact details of our distributor(s) and sales representative(s) in your country.

System and equipment manufacturers and designers are responsible to ensure that their systems, and any Future Technology Devices International Ltd (FTDI) devices incorporated in their systems, meet all applicable safety, regulatory and system-level performance requirements. All application-related information in this document (including application descriptions, suggested FTDI devices and other materials) is provided for reference only. While FTDI has taken care to assure it is accurate, this information is subject to customer confirmation, and FTDI disclaims all liability for system designs and for any applications assistance provided by FTDI. Use of FTDI devices in life support and/or safety applications is entirely at the user's risk, and the user agrees to defend, indemnify and hold harmless FTDI from any and all damages, claims, suits or expense resulting from such use. This document is subject to change without notice. No freedom to use patents or other intellectual property rights is implied by the publication of this document. Neither the whole nor any part of the information contained in, or the product described in this document, may be adapted or reproduced in any material or electronic form without the prior written consent of the copyright holder. Future Technology Devices International Ltd, Unit 1, 2 Seaward Place, Centurion Business Park, Glasgow G41 1HH, United Kingdom. Scotland Registered Company Number: SC136640

## Appendix A – References

### Document References

FT600/FT601 datasheet: [DS\\_FT600Q\\_FT601Q](#)

D3xx Programmable Guide: [AN379](#)

Altera FPGA FIFO Master Programming Guide: [AN377](#)

Xilinx FPGA FIFO Master Programming Guide: [AN376](#)

### Acronyms and Abbreviations

Terms	Description
FIFO	First In First Out
FMC	Field Programmable Mezzanine Card
HPC	High Pin Count
HSMC	High Speed Mezzanine Card
IO	Input Output
LPC	Low Pin Count
USB	Universal Serial Bus

## Appendix B – List of Tables & Figures

### List of Tables

Table 1.1 UMFT60xx Ordering Information .....	1
Table 2.1 CN1 - Micro USB3.0 Pin-out.....	7
Table 2.2 CN2 – POWER JACK 2.1MM .....	7
Table 2.3 JP1 – 5V input Options .....	7
Table 2.4 JP3 – VCC33 Option .....	8
Table 2.5 JP3 – VCCIO Option.....	8
Table 2.6 JP4, JP5 – Configurations.....	8
Table 2.7 CN4 – FMC connector configuration for FIFO bus.....	10
Table 2.8 CN4 – HSMC connector configuration for FIFO bus .....	12
Table 4.1 Board Power Configuration .....	18
Table 4.2 Jumpers Default Position.....	18
Table 4.3 Power Consumption .....	19

### List of Figures

Figure 2-1 UMFT600A Module Top and Bottom View .....	3
Figure 2-2 UMFT601A Module Top and Bottom View .....	3
Figure 2-3 UMFT600X Module Top and Bottom View .....	3
Figure 2-4 UMFT601X Module Top and Bottom View .....	4
Figure 2-5 UMFT600A/UMFT601A Dimensions (Top view).....	5
Figure 2-6 UMFT600A/UMFT601A Dimensions (Side view) .....	5
Figure 2-7 UMFT600X/UMFT601X Dimensions (Top view).....	6
Figure 2-8 UMFT600X/UMFT601X Dimensions (Side view) .....	6
Figure 3-1 Schematics: Power for UMFT600A/UMFT600X/UMFT601A/UMFT601X .....	13
Figure 3-2 Schematics: USB3.0 Bridge_UMFT600A/UMFT600X.....	14
Figure 3-3 Schematics: USB3.0 Bridge_UMFT601A/UMFT601X.....	15
Figure 3-4 Schematics: HSMC_UMFT600A.....	16
Figure 3-5 Schematics: HSMC_UMFT601A.....	16
Figure 3-6 Schematics: FMC_UMFT600X .....	17
Figure 3-7 Schematics: FMC_UMFT601X .....	17
Figure 4-1 Jumpers Locations .....	18



## Appendix C – Revision History

Document Title: UMFT60x FIFO TO USB 3.0 Bridge Evaluation Board  
Document Reference No.: FT\_001191  
Clearance No.: FTDI#457  
Product Page: <http://www.ftdichip.com/Products/ICs/FT600.html>  
Document Feedback: [Send Feedback](#)

Revision	Changes	Date
1.0	Initial Release	2015-08-25