

Operating Instructions

VEGAKON 66

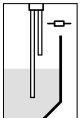
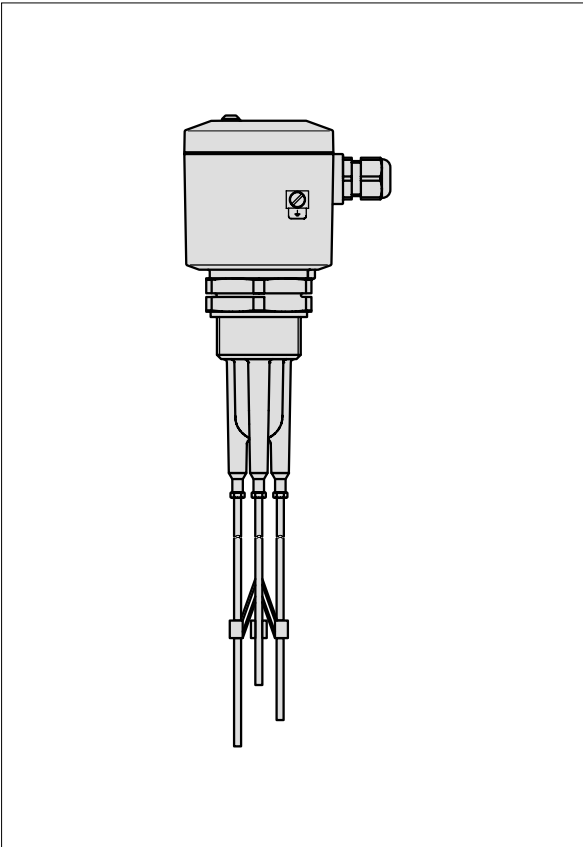

Safety information

Please read this manual carefully, and also take note of country-specific installation standards (e.g. the VDE regulations in Germany) as well as all prevailing safety regulations and accident prevention rules.

For safety and warranty reasons, any internal work on the instruments, apart from that involved in normal installation and electrical connection, must be carried out only by qualified VEGA personnel.

Contents

Safety information	2
1 Product description	
1.1 Function and configuration	4
1.2 Types and version	4
1.3 Approvals	4
1.4 Technical data	5
1.5 Dimensions	7
1.6 Type label	7
2 Mounting	
2.1 General instructions	8
2.2 Installation	8
3 Electrical connection	
3.1 Connection instructions	9
3.2 Connection, relay module	9
3.3 Connection, transistor module	10
4 Setup	
4.1 Indicating and adjustment elements	12
4.2 Switching point adjustment	12
4.3 Functions schedule	15
5 Diagnostics	
5.1 Replacement of electronics	16
5.2 Simulation of switching functions	16

1 Product description

1.1 Function and configuration

VEGAKON 66 conductive compact level switches detect levels of conductive liquids.

Depending on the sensor electronics (module), a relay energises or deenergises or the transistor output is conductive or blocks (mode A or B) see "4.1 Indicating and adjustment elements".

VEGAKON can be used for reliable detection of products over a very wide conductivity and viscosity range.

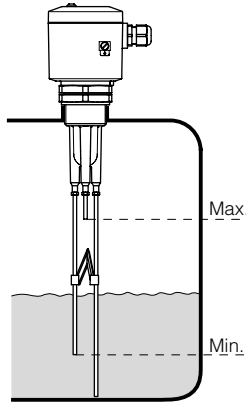

1.2 Types and version

Application

- single point control, double point control

Series

- compact instrument, with socket G 1 1/2 A

Power supply

- with relay module
 - 20 ... 72 V DC
 - 20 ... 250 V AC, 50/60 Hz
- with transistor module
 - 10 ... 55 V DC

Output

- relay module DPDT or
- transistor module

General

- Selectable sensitivity - for adaptation to product conductivity
- Dry adjustment possible
- A/B mode
- Adjustable integration time
- Level simulation
- Exchangeable sensor electronics
- Up to three electrode rods

1.3 Approvals

CE approval

VEGAKON 66 meet the protective regulations of EMC (89/336/EWG) and NSR (73/23/EWG). The conformity has been judged acc. to the following standards:

EMC	Emission	EN 50 081 - 1
	Susceptibility	EN 50 082 - 2
NSR		EN 61 010

1.4 Technical data

Mechanical configuration

Housing

Housing material	plastic PBTP (Polyester) aluminium (plastic coated)
Protection	
- plastic housing	IP 66
- aluminium housing	IP 66/IP 67
Cable entry	
- with relay module (R)	2 x Pg 13.5
- with transistor module (T)	1 x Pg 13.5
Terminal	max. 1 x 1.5 mm ²

Mechanical connection

Socket	
- thread	G 1 $\frac{1}{2}$ A
- material	PP
Electrode rod	
- material	1.4571 (stainless steel)

Weight

VEGAKON 66	approx. 0.6 kg
Rod	approx. 1 kg/m

Electrical configuration

General data

Conductance	min. 0.5 μ S/cm with 3 cm electrode covering (see "4 Setup")
Voltage	approx. 3 V _{eff}
Current	max. 3 mA
Integration time	0.5 ... 20 s (adjustable)
Mode (switchable)	A: max. detection, overfill protection B: min. detection, dry run protection

Transistor module

Power supply	10 ... 55 V DC
Power consumption	max. 0.5 W
Output	floating transistor output overload and permanently shortcircuit proof NPN or PNP action (depending on connection)
Turn-on voltage	U _B = max. 55 V DC
Switching current	I _B = max. 400 mA
Voltage loss on the transistor	U _{CE} 1 V at I _B 400 mA
Blocking current	I _O < 10 μ A
Protection class	II
Overvoltage category	III

Relay module

Supply voltage	20 ... 250 V AC, 50/60 Hz 20 ... 72 V DC
Power consumption	approx. 1 ... 9 VA, max. 1.5 W
Relay data	
- output	relay output (DPDT), 2 floating spdts
- contact material	AgCdO and Au plated
- potential separation	min. 500 V DC
- turn-on voltage	min. 10 mV max. 250 V AC or 250 V DC
- switching current	min. 10 µA max. 5 A AC or 1 A DC
- breaking capacity	max. 750 VA or 54 W DC
Protection class	I
Overvoltage category	II

Operating conditions

Temperatures

Permissible ambient temperature	-40°C ... +70°C
- relay module at	
operating voltage > 60 V DC	-40°C ... +50°C
Storage and transport temperature	-40°C ... +80°C
Permissible product temperature	-40°C ... +100°C

Operating pressure

Max. pressure	6 bar
---------------	-------

1.5 Dimensions

(dimensions in mm)

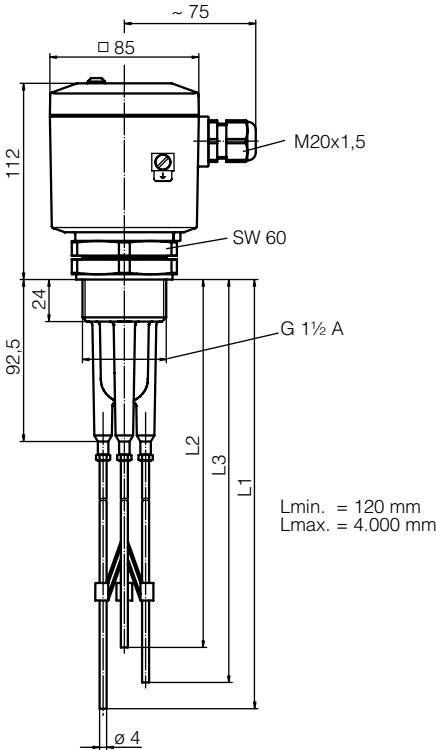

1.6 Type label

Before mounting and electrical connection, please check if you are using the correct instrument. Note the type label, it contains important data and information. The layout and details of the type label are explained in the following example.

Layout of the type label

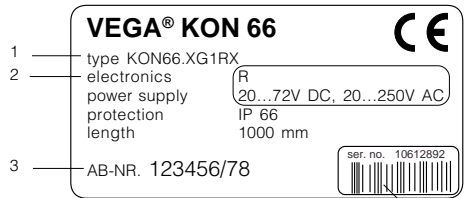

- 1 Master data of the order number
- 2 Electronics data
- 3 Order confirmation number
- 4 Series number

2 Mounting

2.1 General instructions

- Seal VEGAKON on the thread in case of gauge or low pressure. Cover the thread with Teflon tape, hemp or similar or use the supplied seal ring.
- In case of strong vibrations and shocks, e.g. by stirrers or turbulences in the vessel etc., it is possible that the rod of VEGAKON 66 will vibrate or swing. Make sure that with a fastening at the respective location, these vibrations are eliminated or reduced to a minimum.
- With horizontal mounting, rotate the housing, so that after electrical connection, the thread connection point downward. This helps prevent moisture ingress. For this purpose, the housing is rotatable by 330°.
- With lateral mounting, loop the connection line(s) downward from the PG so that rain and condensation water can drain off.
- When mounting a VEGAKON 66 laterally, we recommend installing it approx. 20° inclined that the excess medium can drain off easily and buildup on the insulation is avoided.
- In case of agitated product surfaces, foam generation or strong currents in the vessel, VEGAKON 66 should be mounted in a bypass tube.

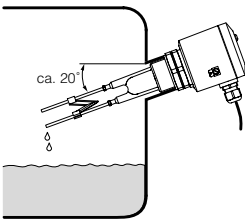

2.2 Installation

- Vertically mounted **with one rod:**
For level detection in metallic vessels. The ground rod can be replaced by the ground connection to the vessel.
Electrodes with a single measuring rod only serve a purpose when detection is done in viscous or highly conductive mediums - in the absence of other rods, no product bridge can form. As a rule, electrodes including an earth rod should be used for all other applications.
- **with two rods:**
for level detection (min. or max.)
- **with three rods:**
for pump control/double point control
- laterally mounted with two rod for level detection

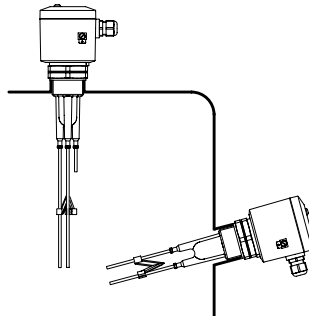

The determination of the rod lengths as well as the response height are explained under "4.2 Switching point adjustment".

3 Electrical connection

3.1 Connection instructions

Danger

Switch off the power supply before starting any connection work.

The electrical connection must be carried out according to the type of electronics in the sensor. Connect mains voltage according to the diagrams on the following pages.

Electrostatic charge

If an electrostatic charge is likely to occur through product motion, it can be eliminated by a connection of the external ground terminal on the housing with the nearest ground potential.

Sensor electronics T-transistor output

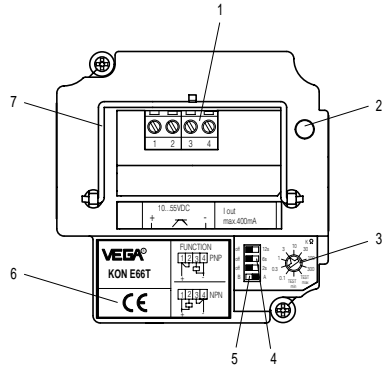

Sensor electronics R-relay output

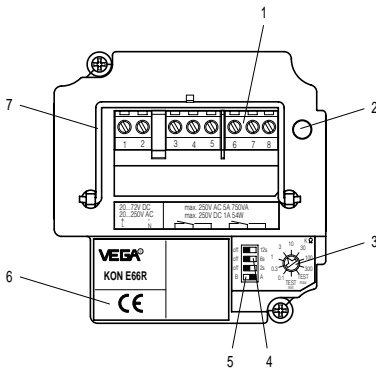

- 1 Terminals
- 2 Control lamp (LED)
- 3 Rotary switch - Conductance adjustment
- 4 Switch - Integration time
- 5 Switch - Mode A/B
- 6 Type label
- 7 Strap

3.2 Connection, relay module

Floating relay output

Power supply:

- 20 ... 250 V AC, 50/60 Hz
- 20 ... 72 V DC

(for further information see "1.4 Technical data")

Used for switching external voltage sources to relays, contactors, magnet valves, signal lamps, horns etc.

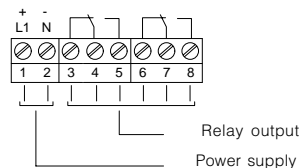

3.3 Connection, transistor module

Floating transistor output

Power supply:

- 10 ... 55 V DC

(for further information see the following connection examples as well as "1.4 Technical data")



The transistor switches a second, galvanically separated voltage source to the binary input of a PLC or to an electrical load.

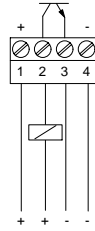

NPN action

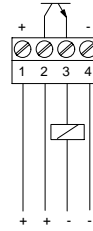

PNP action

Connection examples

The transistor switches the supply voltage of the sensor electronics to the binary input of a PLC or to an electrical load. Through different connections of the consumer (load), PNP or NPN action can be attained.

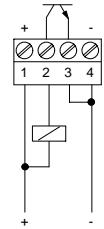

NPN action

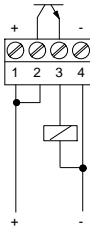

PNP action

The transistor switches a second voltage source with the same reference potential to the binary input of a PLC or to an electrical load.

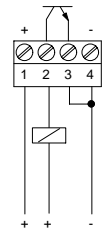

NPN action

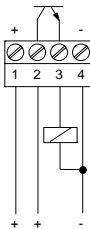

PNP action

Control of alternating current loads

The transistor switches a galvanically separated alternating voltage 10 ... 42 V AC to a load.

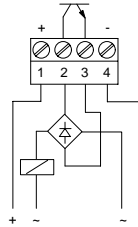

The transistor switches an alternating voltage 10 ... 42 V AC, which is also supply voltage, to a load.

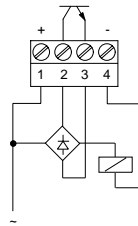

Note

The transistor outputs of several VEGAKON can be connected in series or in parallel to combine their signals logically. The connection must be made so that terminal 2 always has a higher voltage than terminal 3.

Transistor output in conjunction with a PLC (PNP action)

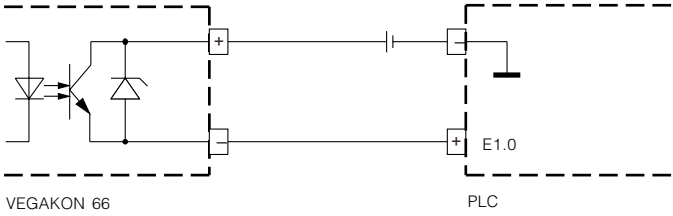

4 Setup

4.1 Indicating and adjustment elements

It is possible to check LED (2) when the housing is closed. To adjust VEGAKON, loosen the four screws on the upper side of the instrument with a screwdriver and remove the housing front cover.

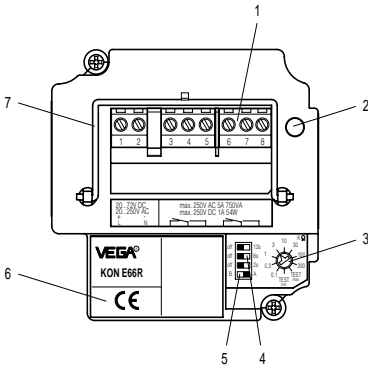

- 1 Terminals
- 2 Control lamp (LED)
- 3 Rotary switch - Conductance adjustment
- 4 Switch - Integration time
- 5 Switch - Mode A/B
- 6 Type label
- 7 Strap

4.2 Switching point adjustment

Position of the rotary switch

Switching point at approx. 1 cm immersion

Rotary switch position (sensitivity)	Conductance (product)
Test max.	Complete immersion is simulated
0.1 kΩ	> 6.6 mS
0.3 kΩ	> 1.7 mS
1 kΩ	> 540 μS
3 kΩ	> 180 μS
10 kΩ	> 54 μS
30 kΩ	> 20 μS
100 kΩ	> 5.7 μS
300 kΩ	> 1.6 μS
Test min.	Empty condition is simulated

Examples of conductance values

Medium	Conductance	recom. rotary switch position
Tap water	0.2 mS	3 kΩ
Salt water (3.5 %)	35 mS	0.1 kΩ
Beer	1.4 mS	1 kΩ
Fruit juice	2 mS	0.3 kΩ
Milk, yoghurt	3 mS	0.3 kΩ
Ketchup	15 mS	0.1 kΩ

Determination of the response height

For horizontally mounted instruments, the installation height determines the response height.

For vertically mounted instruments, the response height is determined by the length of the electrode rods.

Modifying the response height by changing the rotary switch setting (conductance) is not recommended.

The response height can be corrected by shortening (sawing off) the measuring rods. Before shortening, the rods must be removed from the plastic threaded mounting of the sensor.

The numbers of the rods are visible on the lower side of the thread.

The ground rod (no. 1) should have the same length or should be even longer than the other rods.

The max. rod (no. 2) defines the response height for single point level switches or the upper switching level with double point control.

The min. rod (no. 3) defines the lower switching level, it is always longer than the max. rod. It is missing on instruments for single point level detection.

The sensor electronics recognizes if a min. rod is screwed in and changes automatically from single to double point control.

Level detection for max. signal

- Fill the vessel until the shortest electrode is immersed approx. 1 cm.
- Switch on the power supply.
- Set the A/B switch to mode A.
- Set the rotary switch to position "TEST min".
- Turn the rotary switch slowly clockwise until the red LED lights.
- The instrument is adapted to the medium, i.e. the relay deenergises at max. level.

Level detection for min. signal

- Empty the vessel until the min. electrode is immersed approx. 1 cm.
- Switch on the power supply.
- Set the A/B switch to mode B.
- Set the rotary switch to position "TEST max".
- Turn the rotary switch slowly anticlockwise until the red LED lights.
- The instrument is adapted to the medium, i.e. the relay deenergises at min. level.

Pump control, mode A

- Fill the vessel until the shortest electrode is immersed approx. 1 cm.
- Switch on the power supply.
- Set the A/B switch to mode A.
- Set the rotary switch to position "TEST min".
- Turn the rotary switch slowly clockwise until the red LED lights.
- The instrument is adapted to the medium, i.e. the relay deenergises at max. level. The relay energises again only when the level drops below the lowest point of the min. electrode.

Example:

A filling pump is switched on when the min. signal is reached, fills the vessel until the max. signal is reached and is then switched off.

Pump control, mode B

- Empty the vessel until the min. electrode is immersed approx. 1 cm.
- Switch on the power supply.
- Set the A/B switch to mode B.
- Set the rotary switch to position "TEST max".
- Turn the rotary switch slowly anticlockwise until the red LED lights.
- The instrument is adapted to the medium, i.e. the relay energises at max. level. The relay deenergises when the level drops below the min. electrode.

Example:









An emptying pump is switched on when the max. signal is reached, empties the vessel until the min. signal is reached and is then switched off.

Dry adjustment

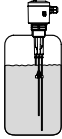

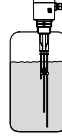
- With several identical measurement loop (the same medium), the adjustment of one instrument with the medium is sufficient, the determined switch position can be transferred to all further instruments.
- If the conductance value is known, the switching point adjustment can be carried out acc. to the schedule "Rotary switch position" (under "4.2 Switching point adjustment").
- When exchanging the sensor electronics, it is sufficient to carry over the settings from the previous unit.

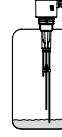
4.3 Functions schedule

The following schedule provides an overview of the switching conditions as they relate to the set mode and level.

	Level	Switching condition relay module KON E66 R	Switching conditioning transistor module KON E66 T	Control lamp VEGAKON
Mode A Max. detection or overflow protection		Relay energised 	Transistor conductive	does not light 
		Relay deenergised 	Transistor blocked	lights 
Mode B Min. detection or dry run protection		Relay energised 	Transistor conductive	does not light 
		Relay deenergised 	Transistor blocked	lights 

Power supply failure

Mode A/B	any	Relay energised 	Transistor blocked	does not light 
----------	-----	--	--------------------	---

Note

If VEGAKON 66 is used for oil warning in water, the oil coating has to be removed from the electrode after responding to oil (= empty signal) as otherwise a correct response to water would not be ensured.

5 Diagnostics

5.1 Replacement of electronics

Replacing the electronics modules is no problem, since they are subject to narrow limits of variation and require no adaptation to other sensor (mechanical or electrical) components.

Before removing the electronics module, the positions of the conductance switch, the mode switches and the integration switch should be noted. Set the new electronics module to the same values. A fresh adjustment to the medium is unnecessary. As soon as you insert the sensor electronics, the VEGAKON is ready for operation.

5.2 Simulation of switching functions

With the switch positions "Test max." and "Test min.", full immersion (max.) or empty immersion (min.) can be simulated. It is not possible to move the medium. The level of the medium does not have to be raised or lowered. This enables you to check the response of the signalling and switching systems which are controlled by VEGAKON 66. Certain parts of the sensor electronics are also checked during the test.

VEGA

VEGA Grieshaber KG
Am Hohenstein 113
D-77761 Schiltach
Phone (0 78 36) 50 - 0
Fax (0 78 36) 50 - 201
e-mail info@vega-g.de



The statements on types, application, use and operating conditions of the sensors and processing systems correspond to the latest information at the time of printing.

Technical data subject to alteration