



DESCRIPTION

A level control relay for most conductive fluids. With a 2 or 3 wire probe, one or two levels in a container can be controlled.

The probe is a conducting rod, the length of which can be adjusted to the container and the levels which have to be controlled.

To control 1 level (2-wire probes), one of the probes is constantly covered by the fluid and the length of the probe dictates the level. To control 2 levels (3-wire probes), one of the probes is constantly covered by fluid and the length of the two other probes dictates min. and max. levels.

As conductivity will differ from fluid to fluid, the sensitivity can be adjusted on the front panel, to adjust the reaction time from the time the actual level is registered, to the relay being energised/de-energised.

Features

- Monitoring/control of levels of conducting fluids via 2 or 3 wire probes.
- Signal at max. and min. level in the same version.
- Sensitivity adjustable on input 5 - 50kOhm.
- Response time adjustable 0,1 - 5 sec.
- Automatic locking (Latch).
- Output SPDT.
- Supply voltage 24/115VAC or 24/230VAC and 24VDC.

VERSION/ORDERING CODES

Type:
Level relay

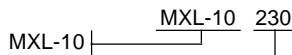

Supply voltage
24V DC
115V AC / 24V AC
230V AC / 24V AC



OPERATION

Signal at maximum (with jumper).

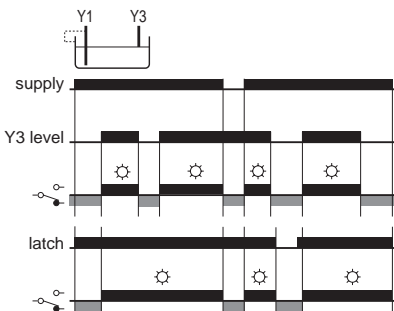
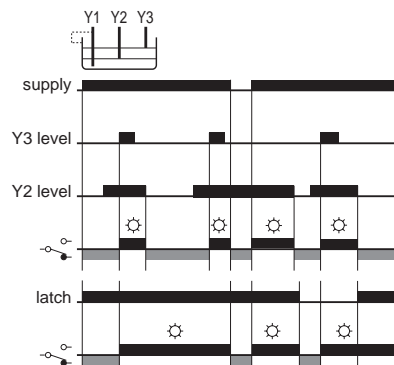

Signal at minimum (without jumper)

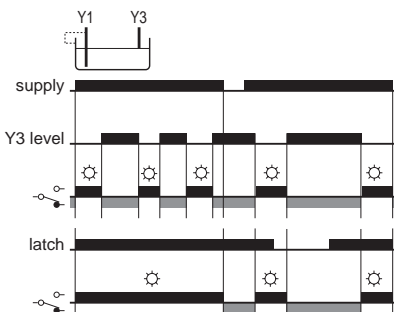
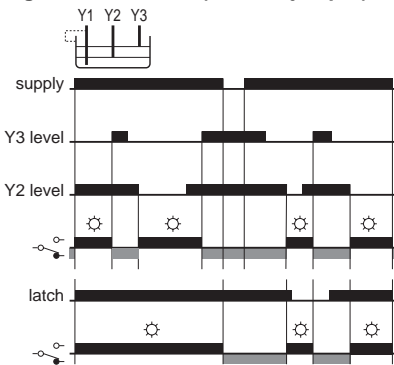

TECHNICAL DATA

Input:

Sensitivity: 5kOhm-50kOhm, adjustable.
 Probe Voltage: Max. 12Vp-p AC, 1kHz.
 Probe current: Max. 360µA.
 Temperature drift: Max. 0,05%/°C.
 Hysteresis: <0,1%.
 Reaction time: 0,1-5s, adjustable.
 Probe Cabel: Max. length 100m.
 Capacity max. 10nF.
 Isolation resistance>220kOhm.

Output:

SPDT relay: Contact material, AgNi 0,15 with hardened gold plating Au.
 Max. load AC: 8A/240V AC (cosφ=1)
 Max. breaking capacity 2000VA. Inductive load. See fig.1.
 Max. load DC: 8A/24V DC.
 Max. breaking capacity 50-270W. See fig. 2.
 Max in rush current: 15A (max. 4s/duty cycle less than 10%).
 Min in rush current: 10mA, 24V DC.
 Frequency : Max. 1000 operations pr. hour.

Life time: Mech. Min. 1x 10⁵ operations.
 Elect. Min. 3 x 10⁷ operations with full load.
 Delay: <20ms.

Supply voltage:

Versions: 924=24V DC (20,4-27,6)V DC
 115=24/115V AC (20,4-27,6/98-132)V AC
 230=24/230V AC (20,4-27,6/196-264)V AC
 Net frequency: 45-65Hz
 Consumption: AC; 3VA
 DC; 2W

General data::

Ambient temperature:-20 to 55°C.
 Storage temperature:-40 to 80°C.
 Mounting: 35mm DIN-rail (EN50022).
 Terminals: Screw terminals with dual compartment.
 Terminal screws are combined crosshead/slotted. Up to 2 x 2,5mm² wire (2 x 1,5mm² inc. ferrule).
 Recommended torque, 0,5Nm, max 0,7Nm (VDE0609-1).
 Terminal identification in accordance with DIN46199/EN50005.
 Indicators: Green LED = operating voltage
 Red LED = relay switched on.
 Protection: IP20
 Electric isolation: 3,75kVAC (1 min.) between input, supply and relay output (EN60950)
 Housing: Noryl (GE), UL94V1.
 Terminal block: Noryl (GE), UL94V0.
 Weight: 180 g.

WIRING DIAGRAM

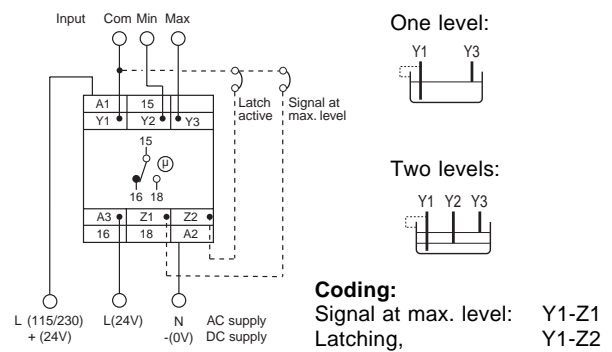

SPECIFICATIONS:

- MXL-10 is designed and developed with regard to relevant specifications:
- EN60204-1 / VDE0113 electrical material on machines.
 - VDE0110 / IEC664 Isolation specifications/creepage and clearance distances.
 - Electrical safety in accordance with EN61010.
 - IEC414 Safety regulations for control and monitoring equipment.
 - EMC: Emission EN50081-1.
Immunity EN50082-2.
 - Humidity in accordance with IEC68-2-3; RH=95%, 40°C.
 - Vibration in accordance with IEC68-2-6:.
 - Shock when mounted, in accordance with IEC68-2-27.

MXL-10 is CE-marked in accordance with EMC-and the Low Voltage Directive.

OUTPUT LOAD DIAGRAMS

Fig. 1

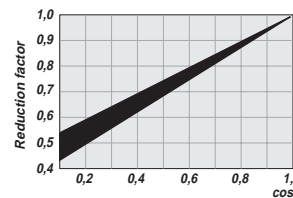
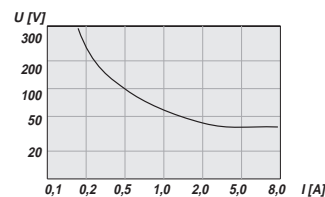

Fig. 2



MECHANICAL DIMENSIONS

