

## Standard RPTS Q555 24 Hour, 4-pin Time Switch with 1 or 2 ON/OFF Operations with 100 Hour Battery Reserve



### Benefits

Q555 - 24 hour quartz controlled with battery reserve, 4 pin base.

- .2 - Up to two ON and two OFF operations per day.
- .3 - Up to two ON and two OFF operations per day.

The 24 hour programming cycle performs the same sequence of switching operations on each day and can be quickly and easily set using the small manual levers on the dial. A "day omit" device allows you to select any number of days in the week on which the switching cycle can be disabled. A general purpose timeswitch for heating, ventilation and equipment control applications.

### Dimensions

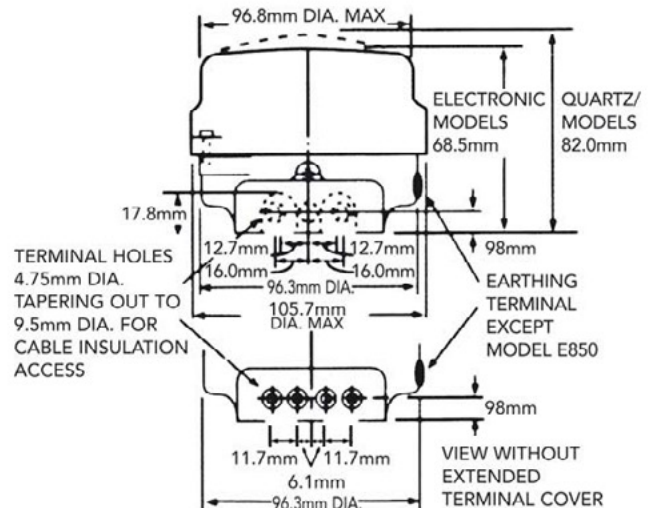
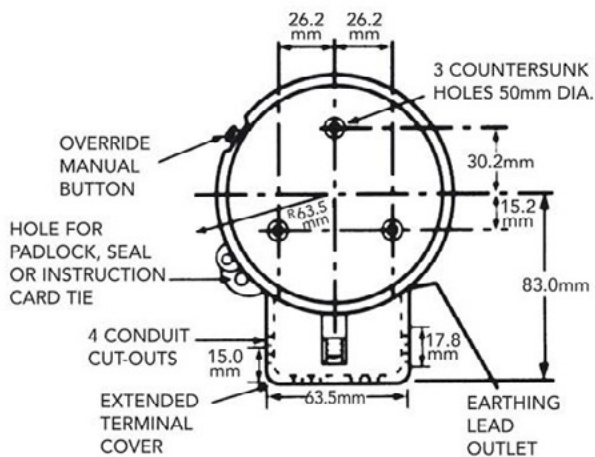

## Technical Data

<i>Programming</i>	<i>24 hour programme with 1 or 2 ON/OFF operations per day</i>
<i>Display</i>	<i>24 hour dial</i>
<i>Mounting</i>	<i>Surface mounting</i>
<i>Current Rating</i>	<i>SPST: 20amp resistive</i>
<i>Supply</i>	<i>230V, 50/60 Hz a.c.</i>
<i>Base Type</i>	<i>4 Pin</i>
<i>Reserve</i>	<i>100 hrs (providing battery has been charged for 300 hrs)</i>
<i>Day Omission</i>	<i>Yes (omitts the "ON" operation)</i>
<i>Temp Override Facility (Manual Button)</i>	<i>Advance to "OFF", when program "ON" and will remain "OFF" unit next "ON" operation and vice versa</i>
<i>Cable Size</i>	<i>6.0mm<sup>2</sup></i>
<i>Timing Accuracy</i>	<i>5 mins/year</i>
<i>Power Consumption</i>	<i>0.6W at 230V</i>
<i>Ambient Temperature Range</i>	<i>Designed to operate over a temperature range of 0°C to 50°C continuous</i>
<i>Live Parts Protection</i>	<i>This timer is totally protected by its enclosure</i>
<i>Dirt Protection</i>	<i>Normal domestic dust deposits only</i>
<i>Moisture Protection</i>	<i>Ordinary: has no special protection against moisture</i>
<i>Shock Protection</i>	<i>Class 1 (Product must be earthed)</i>
<i>Dial Calibration</i>	<i>15 min divisions</i>
<i>Setting Accuracy</i>	<i>+/- 3 minutes</i>
<i>BEAB Approval</i>	<i>Yes</i>
<i>Dimensions</i>	<i>Height (wall mounted) 136mm, width 105.7mm, projection 82mm, (Total height 146.5mm)</i>

## Electrical Connections

### Internal Wiring Diagram

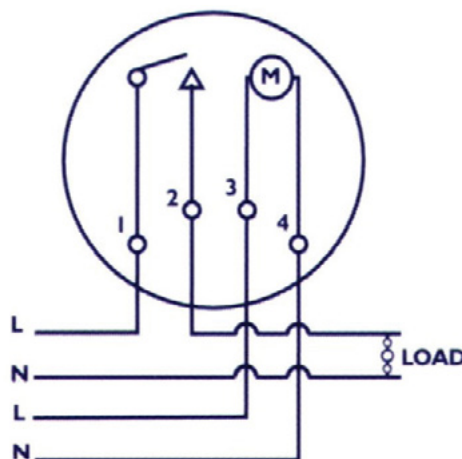

## Technical Helpline: 01475 745131

### CUSTOMER CARE POLICY

As part of Sangamo's continuous improvement program, the Company operates a Customer Care Policy. This means that we welcome your comments and complaints, as it can only help us to improve our services to you, our customer.

**SANGAMO**



Certificate Q05237



Certificate EMS 80426

Sangamo Limited, Industrial Estate, Port Glasgow,  
Renfrewshire PA14 5XG

Tel: 01475 745131 Fax: 01475 744567

Email : enquiries@sangamo.co.uk Web: www.sangamo.co.uk

RPTS007B