

Digital Indicators **K3HB-S/-X/-V/-H**

User's Manual

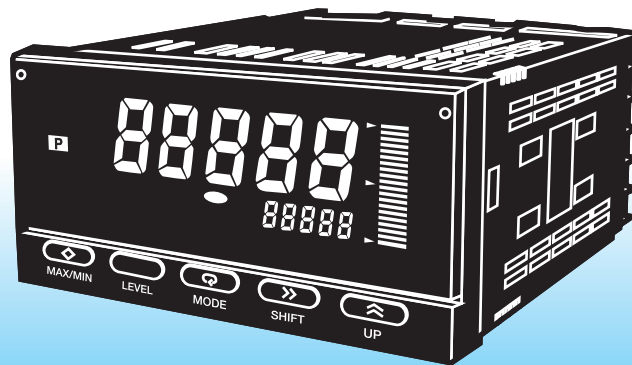

Preface

Thank you for purchasing the K3HB.

This manual describes the functions, performance, and application methods needed for optimum use of the K3HB.

Please observe the following items when using the K3HB.

- This product is designed for use by qualified personnel with a knowledge of electrical systems.
- Read this manual carefully and make sure you understand it well to ensure that you are using the K3HB correctly.
- Keep this manual in a safe location so that it is available for reference when required.

Notice

- (1) All rights reserved. No part of this manual may be reprinted or copied without the prior written permission of OMRON.
- (2) The specifications and other information contained in this manual are subject to change without notice in order to make improvements.
- (3) Every precaution has been taken in the preparation of this manual. Nevertheless, OMRON assumes no responsibility for errors or omissions. If you discover any problems with this manual, please notify your nearest OMRON representative, providing them with the catalog number provided on the cover.

Read and Understand this Manual

Please read and understand this manual before using the product. Please consult your OMRON representative if you have any questions or comments.

Warranty and Limitations of Liability

WARRANTY

OMRON's exclusive warranty is that the products are free from defects in materials and workmanship for a period of one year (or other period if specified) from date of sale by OMRON.

OMRON MAKES NO WARRANTY OR REPRESENTATION, EXPRESS OR IMPLIED, REGARDING NON-INFRINGEMENT, MERCHANTABILITY, OR FITNESS FOR PARTICULAR PURPOSE OF THE PRODUCTS. ANY BUYER OR USER ACKNOWLEDGES THAT THE BUYER OR USER ALONE HAS DETERMINED THAT THE PRODUCTS WILL SUITABLY MEET THE REQUIREMENTS OF THEIR INTENDED USE. OMRON DISCLAIMS ALL OTHER WARRANTIES, EXPRESS OR IMPLIED.

LIMITATIONS OF LIABILITY

OMRON SHALL NOT BE RESPONSIBLE FOR SPECIAL, INDIRECT, OR CONSEQUENTIAL DAMAGES, LOSS OF PROFITS OR COMMERCIAL LOSS IN ANY WAY CONNECTED WITH THE PRODUCTS, WHETHER SUCH CLAIM IS BASED ON CONTRACT, WARRANTY, NEGLIGENCE, OR STRICT LIABILITY.

In no event shall the responsibility of OMRON for any act exceed the individual price of the product on which liability is asserted.

IN NO EVENT SHALL OMRON BE RESPONSIBLE FOR WARRANTY, REPAIR, OR OTHER CLAIMS REGARDING THE PRODUCTS UNLESS OMRON'S ANALYSIS CONFIRMS THAT THE PRODUCTS WERE PROPERLY HANDLED, STORED, INSTALLED, AND MAINTAINED AND NOT SUBJECT TO CONTAMINATION, ABUSE, MISUSE, OR INAPPROPRIATE MODIFICATION OR REPAIR.

Application Considerations

SUITABILITY FOR USE

OMRON shall not be responsible for conformity with any standards, codes, or regulations that apply to the combination of products in the customer's application or use of the products.

At the customer's request, OMRON will provide applicable third party certification documents identifying ratings and limitations of use that apply to the products. This information by itself is not sufficient for a complete determination of the suitability of the products in combination with the end product, machine, system, or other application or use.

The following are some examples of applications for which particular attention must be given. This is not intended to be an exhaustive list of all possible uses of the products, nor is it intended to imply that the uses listed may be suitable for the products.

- Outdoor use, uses involving potential chemical contamination or electrical interference, or conditions or uses not described in this manual.
- Nuclear energy control systems, combustion systems, railroad systems, aviation systems, medical equipment, amusement machines, vehicles, safety equipment, and installations subject to separate industry or government regulations.
- Systems, machines, and equipment that could present a risk to life or property.

Please know and observe all prohibitions of use applicable to the products.

NEVER USE THE PRODUCTS FOR AN APPLICATION INVOLVING SERIOUS RISK TO LIFE OR PROPERTY WITHOUT ENSURING THAT THE SYSTEM AS A WHOLE HAS BEEN DESIGNED TO ADDRESS THE RISKS, AND THAT THE OMRON PRODUCTS ARE PROPERLY RATED AND INSTALLED FOR THE INTENDED USE WITHIN THE OVERALL EQUIPMENT OR SYSTEM.

PROGRAMMABLE PRODUCTS

OMRON shall not be responsible for the user's programming of a programmable product, or any consequence thereof.

Disclaimers

CHANGE IN SPECIFICATIONS

Product specifications and accessories may be changed at any time based on improvements and other reasons.

It is our practice to change model numbers when published ratings or features are changed, or when significant construction changes are made. However, some specifications of the products may be changed without any notice. When in doubt, special model numbers may be assigned to fix or establish key specifications for your application on your request. Please consult with your OMRON representative at any time to confirm actual specifications of purchased products.

DIMENSIONS AND WEIGHTS

Dimensions and weights are nominal and are not to be used for manufacturing purposes, even when tolerances are shown.

PERFORMANCE DATA

Performance data given in this manual is provided as a guide for the user in determining suitability and does not constitute a warranty. It may represent the result of OMRON's test conditions, and the users must correlate it to actual application requirements. Actual performance is subject to the OMRON Warranty and Limitations of Liability.

ERRORS AND OMISSIONS

The information in this document has been carefully checked and is believed to be accurate; however, no responsibility is assumed for clerical, typographical, or proofreading errors, or omissions.

Safety Precautions

● Definition of Precautionary Information

The following notation is used in this manual to provide precautions required to ensure safe usage of the product.





The safety precautions that are provided are extremely important to safety. Always read and heed the information provided in all safety precautions.

The following notation is used.



 WARNING	<p>Indicates a potentially hazardous situation which, if not avoided, will result in minor or moderate injury, or may result in serious injury or death. Additionally there may be significant property damage.</p>
--------------------------------------------------------------------------------------------------	---------------------------------------------------------------------------------------------------------------------------------------------------------------------------------------------------------------------



 CAUTION	<p>Indicates a potentially hazardous situation which, if not avoided, may result in minor or moderate injury or in property damage.</p>
--------------------------------------------------------------------------------------------------	-----------------------------------------------------------------------------------------------------------------------------------------

● Symbols

Symbol		Meaning
Caution		<p>General Caution Indicates non-specific general cautions, warnings, and dangers.</p>
		<p>Electrical Shock Caution Indicates possibility of electric shock under specific conditions.</p>
Prohibition		<p>General Prohibition Indicates non-specific general prohibitions.</p>
Mandatory Caution		<p>General Caution Indicates non-specific general cautions, warnings, and dangers.</p>

● Precautions

 WARNING	
Do not touch the terminals while power is being supplied. Doing so may possibly result in electric shock. Make sure that the terminal cover is installed before using the product.	
Always provide protective circuits in the network. Without protective circuits, malfunctions may possibly result in accidents that cause serious injury or significant property damage. Provide double or triple safety measures in external control circuits, such as emergency stop circuits, interlock circuits, or limit circuits, to ensure safety in the system if an abnormality occurs due to malfunction of the product or another external factor affecting the product's operation.	

 CAUTION	
Do not allow pieces of metal, wire clippings, or fine metallic shavings or filings from installation to enter the product. Doing so may occasionally result in electric shock, fire, or malfunction.	
Do not use the product in locations where flammable or explosive gases are present. Doing so may occasionally result in minor or moderate explosion, causing minor or moderate injury, or property damage.	
Do not attempt to disassemble, repair, or modify the product. Doing so may occasionally result in minor or moderate injury due to electric shock.	
Do not use the equipment for measurements within Measurement Categories III and IV for K3HB-X and II, III, and IV for K3HB-S, K3HB-V, and K3HB-H (according to IEC61010-1). Doing so may occasionally cause unexpected operation, resulting in minor or moderate injury, or damage to the equipment. Use the equipment for measurements only within the Measurement Category for which the product is designed.	
Perform correct setting of the product according to the application. Failure to do so may occasionally cause unexpected operation, resulting in minor or moderate injury, or damage to the equipment.	
Ensure safety in the event of product failure by taking safety measures, such as installing a separate monitoring system. Product failure may occasionally prevent operation of comparative outputs, resulting in damage to the connected facilities and equipment.	
Tighten the screws on the terminal block and the connector locking screws securely using a tightening torque within the following ranges. Loose screws may occasionally cause fire, resulting in minor or moderate injury, or damage to the equipment. Terminal block screws: 0.43 to 0.58 N·m Connector locking screws: 0.18 to 0.22 N·m	

 **CAUTION**

Make sure that the product will not be adversely affected if the DeviceNet cycle time is lengthened as a result of changing the program with online editing. Extending the cycle time may cause unexpected operation, occasionally resulting in minor or moderate injury, or damage to the equipment.

Before transferring programs to other nodes or changing I/O memory of other nodes, check the nodes to confirm safety. Changing the program or I/O memory of other nodes may occasionally cause unexpected operation, resulting in minor or moderate injury, or damage to the equipment.



Precautions for Safe Use

- (1) Do not use the product in the following locations.
 - Locations subject to direct radiant heat from heating equipment
 - Locations where the product may come into contact with water or oil
 - Locations subject to direct sunlight
 - Locations where dust or corrosive gases (in particular, sulfuric or ammonia gas) are present
 - Locations subject to extreme temperature changes
 - Locations where icing or condensation may occur
 - Locations subject to excessive shocks or vibration
- (2) Do not use the product in locations subject to temperatures or humidity levels outside the specified ranges or in locations prone to condensation. If the product is installed in a panel, ensure that the temperature around the product (not the temperature around the panel) does not go outside the specified range.
- (3) Provide sufficient space around the product for heat dissipation.
- (4) Use and store the product within the specified temperature and humidity ranges. If several products are mounted side-by-side or arranged in a vertical line, the heat dissipation will cause the internal temperature of the products to rise, shortening the service life. If necessary, cool the products using a fan or other cooling method.
- (5) The service life of the output relays depends on the switching capacity and switching conditions. Consider the actual application conditions and use the product within the rated load and electrical service life. Using the product beyond its service life may result in contact welding or burning.
- (6) Install the product horizontally.
- (7) Mount to a panel between 1 and 8-mm thick.
- (8) Use the specified size of crimp terminals (M3, width: 5.8 mm max.) for wiring. To connect bare wires, use AWG22 (cross section: 0.326 mm²) to AWG14 (cross section: 2.081 mm²) to wire the power supply terminals and AWG28 (cross section: 0.081 mm²) to AWG16 (cross section: 1.309 mm²) for other terminals. (Length of exposed wire: 6 to 8 mm)
- (9) In order to prevent inductive noise, wire the lines connected to the product separately from power lines carrying high voltages or currents. Do not wire in parallel with or in the same cable as power lines. Other measures for reducing noise include running lines along separate ducts and using shield lines.
- (10) Ensure that the rated voltage is achieved no longer than 2 s after turning the power ON.
- (11) Allow the product to operate without load for at least 15 minutes after the power is turned ON.
- (12) Do not install the product near devices generating strong high-frequency waves or surges. When using a noise filter, check the voltage and current and install it as close to the product as possible.
- (13) Do not use thinner to clean the product. Use commercially available alcohol.
- (14) Be sure to confirm the name and polarity for each terminal before wiring the terminal block and connectors.
- (15) Use the product within the noted supply voltage and rated load.

- (16) Do not connect anything to unused terminals.
- (17) Output turns OFF when the mode is changed or settings are initialized. Take this into consideration when setting up the control system.
- (18) Install an external switch or circuit breaker that complies with applicable IEC60947-1 and IEC60947-3 requirements and label them clearly so that the operator can quickly turn OFF the power.
- (19) Use the specified cables for the communications lines and stay within the specified DeviceNet communications distances. Refer to the User's Manual (Cat. No. N129) for details on communications distance specifications and cables.
- (20) Do not pull the DeviceNet communications cables with excessive force or bend them past their natural bending radius.
- (21) Do not connect or remove connectors while the DeviceNet power is being supplied. Doing so will cause product failure or malfunction.
- (22) Use cables with a heat resistance of 70°C min.

● Noise Countermeasures

Do not install the product near devices generating strong high-frequency waves or surges, such as high-frequency welding and sewing machines.

- (1) Mount a surge suppressor or noise filter to peripheral devices generating noise, in particular, motors, transformers, solenoids, and magnet coils.

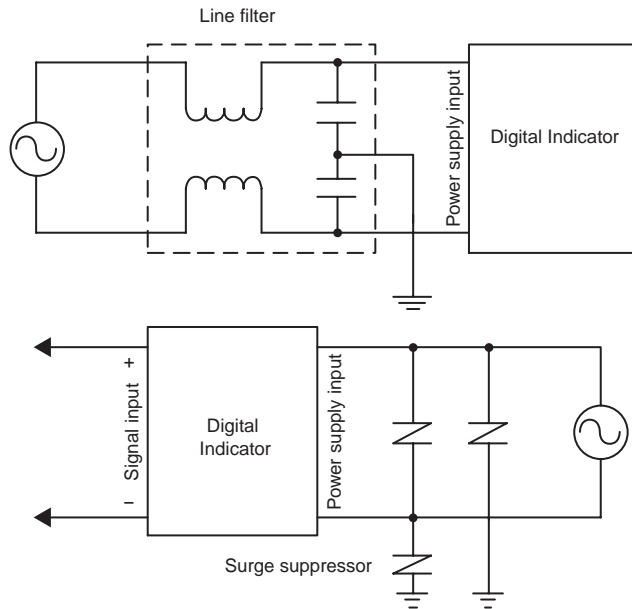

- (2) In order to prevent inductive noise, wire the lines connected to the terminal block separately from power lines carrying high voltages or currents. Do not wire in parallel with or in the same cable as power lines. Other measures for reducing noise include running lines along separate ducts and using shield lines.

Example of Countermeasures for Inductive Noise on Input Lines

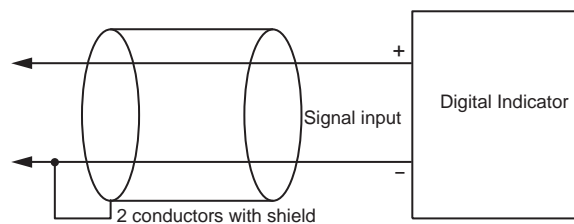

- (3) If a noise filter is used for the power supply, check the voltage and current, and install the noise filter as close to the product as possible.
- (4) Reception interference may occur if the product is used close to a radio, television, or wireless.

● Revision History

The revision code of this manual is given at the end of the catalog number at the bottom left of the back cover.

Cat. No.	N128-E1-01B
-----------------	--------------------

Revision code	Date	Pages and changes
01	November 2003	Original production
01A	January 2004	Page 2-4: Bottom left portion of C corrected. Page A-5: Information updated for "applicable standards."
01B	March 2005	Page 1-4: Power interruption memory added. Page 2-4: Added information on BCD Output Cable at bottom of page. Pages 2-4, A-11, and A-17: Changed K34-B4 to K34-BCD. Pages 2-5: Added information on Special Cable (for Event Inputs with 8-pin Connector) at bottom of page. Page 2-7: "Min." changed to "max." at bottom of page. Page 2-12: Corrected the maximum measurement range of input range B for DC voltage. Page 2-13: Changed K2HB-V to K3HB-V in heading. Page 5-29: Underlined the phrase in the first line of the page to draw user's attention. Page 5-83: Text added after table. Page 6-9: Middle rows of table reversed. Pages A-2: Changed "XAD" to "XVA" and "XVA" to "XAD" in left column. Page A-3: Changed column division within table under <i>Event inputs</i> , i.e., <i>Startup compensation timer input</i> was moved to the same column as for the <i>Hold input</i> . Page A-3: Changed "max." to "min." for the load resistance specification of the linear output. Page A-10: Added information on BCD to table 4.

About this Manual

Manual Structure

Preface

Provides precautionary information, a manual revision history, an overview of the manual contents, information on using this manual, and other general information.

Section 1 Outline

Provides an overview and describes the features of the product.

Section 2 Preparations

Describes the mounting and wiring required before using the product.

Section 3 Basic Application Methods

Shows typical applications for the product. Also shows wiring and parameter settings which enables the user to understand how to use the product from practical examples.

Section 4 Initial Setup

Describes the initial setup process when using this product.

Section 5 Functions and Operations

Describes the functions and settings methods for more effective use of functions, displays, outputs, and settings for each application.

Section 6 User Calibration

Describes the methods for user calibration.

Section 7 Troubleshooting

Describes how to check and possible countermeasures for errors.

Appendices

Provides specifications and settings lists.

● Settings Data Notation

The letters of the alphabet in settings data are displayed as shown below.

<i>A</i>	<i>b</i>	<i>c</i>	<i>d</i>	<i>E</i>	<i>F</i>	<i>G</i>	<i>H</i>	<i>i</i>	<i>j</i>	<i>K</i>	<i>L</i>	<i>M</i>
A	B	C	D	E	F	G	H	I	J	K	L	M
<i>n</i>	<i>o</i>	<i>P</i>	<i>q</i>	<i>r</i>	<i>S</i>	<i>t</i>	<i>U</i>	<i>v</i>	<i>w</i>	<i>X</i>	<i>Y</i>	<i>Z</i>
N	O	P	Q	R	S	T	U	V	W	X	Y	Z

● Applicable Model Notation

The following symbols are used to indicate the applicable models for specific functions.

- X K3HB-X□□
- V K3HB-V□□
- H K3HB-H□□
- S K3HB-S□□

CONTENTS

Section 1 Outline

1.1	Main Functions and Features of the K3HB	1-2
1.2	Component Names and Functions	1-5
1.3	Internal Block Diagram.	1-6

Section 2 Preparations

2.1	Mounting.	2-2
2.2	Using I/O.	2-4

Section 3 Basic Application Methods

3.1	Monitoring Tank Levels	3-2
3.2	Monitoring Motor Load Current.	3-6
3.3	Weighing Material.	3-9
3.4	Temperature Monitoring/Control with Multi-level Output.	3-11
3.5	Product Height Measurement and OK/NG Judgement.	3-14
3.6	Panel Thickness Inspection.	3-17
3.7	Measurement of Disk Eccentricity	3-20
3.8	Step Inspection	3-22

Section 4 Initial Setup

4.1	K3HB-X Initial Setup Example (K3HB-XVD)	4-2
4.2	K3HB-V Initial Setup Example (K3HB-VLC).	4-4
4.3	K3HB-H Initial Setup Example (K3HB-HTA).	4-6
4.4	K3HB-S Initial Setup Example (K3HB-SSD)	4-8

Section 5 Functions and Operations

	Knowledge Required for Setting Parameters	5-2
	-----Operation Adjustments -----	
5.1	Setting Calculations	5-9
5.2	Setting Input Types	5-11
5.3	Setting Scaling Values.	5-14
5.4	Setting the Temperature Unit	5-18
5.5	Setting Measurement Operations	5-19
5.6	Shifting the Temperature Input	5-24
5.7	Resetting Measurements	5-26
5.8	Not Performing Measurements for Set Intervals	5-27

---- Input Adjustments -----	
5.9	Selecting Operations for Input Errors. 5-29
5.10	Disabling Cold Junction Compensation 5-31
5.11	Adjusting Timing Inputs. 5-33
5.12	Eliminating Drift Near “0” 5-36
5.13	Averaging Inputs. 5-38
5.14	Detecting Sudden Input Changes 5-41
---- Output Adjustments -----	
5.15	Changing Comparative Output Patterns 5-44
5.16	Preventing Output Chattering 5-46
5.17	Outputting for a Set Interval 5-49
5.18	Delaying Output OFF Timing 5-52
5.19	Holding Measurement Status 5-54
5.20	Holding Comparative Outputs 5-55
5.21	Allocating Another Output to PASS Output 5-57
5.22	Reversing Output Logic 5-59
5.23	No Output before PASS Range. 5-61
5.24	Performing Linear Output 5-63
---- Display Adjustments -----	
5.25	Setting the Present Measurement Value to “0”. 5-65
5.26	Setting the Present Measurement Value to “0” Again when Using a Forced Zero 5-67
5.27	Compensating Forced-zero References 5-70
5.28	Changing Display Refresh Periods. 5-73
5.29	Holding Maximum and Minimum Values 5-75
5.30	Changing Normal Display Values to Maximum and Minimum Values 5-78
5.31	Setting the Step for Changing the Rightmost Digit 5-80
5.32	Displaying/Not Displaying Comparative Set Values 5-82
5.33	Changing Display Colors 5-83
5.34	Using the Position Meter 5-85
5.35	Automatic Return to Normal Display. 5-88
5.36	No Decimal Point Display 5-90
---- Other Operations -----	
5.37	Performing Output Tests. 5-92
5.38	Using Comparative Set Value Banks 5-93
5.39	Copying Bank Comparative Set Values 5-98
5.40	Initializing All Settings. 5-100
5.41	Limiting Key Operations 5-102

Section 6 User Calibration

6.1	About User Calibration. 6-2
6.2	User Calibration Operation. 6-5

Section 7 Troubleshooting

7.1 Error Displays	7-2
7.2 Countermeasures	7-3

Appendices

Specifications	A-2
Model Numbers	A-9
Parameter List	A-12
Parameter Display Conditions	A-17
About Parameters	A-19
Sampling and Comparative Output Response Times	A-26
No Measurement Status	A-30

Section 1 Outline

1.1	Main Functions and Features of the K3HB	1-2
1.2	Component Names and Functions	1-5
1.3	Internal Block Diagram	1-6

1.1 Main Functions and Features of the K3HB

Measurement

Input calculation

Two measurement values can be added, subtracted, or the ratio calculated. In addition, any constant can be set and measurement values can be added to or subtracted from a constant.

→ P.5-9

S

Timing hold

Using external timing signal inputs, synchronous measurements can be made and maximum values, minimum values, and the difference between maximum and minimum values can be measured.

→ P.5-18

X V S H

Timing delay

The start and stop timing for measurements can be adjusted using timing signals.

→ P.5-33

X V S H

Filter

Average processing

Average processing of input signals with extreme changes or noise smooths out the display and makes control stable.

→ P.5-38

X V S H

Previous average value comparison

Slight changes can be removed from input signals to detect only extreme changes.

→ P.5-41

X V S H

Input compensation

Forced-zero

Forces the present value to 0. Effective to set a reference value from which to perform measurements.

→ P.5-65

X V S

Tare zero

Shifts the current value measured with a forced zero to 0 again. Effective, for example, when two compounds are measured separately.

→ P.5-67

X V S

Zero-trimming

Compensates for gradual changes in input signals from, for example, sensor temperature drift, based on OK data (PASS data) at measurement.

→ P.5-70

X V S

Zero-limit

Changes the display value to 0 for input values less than the set value.

Effective when drift and displacement of values near zero need to be eliminated.

→ P.5-36

X V S

Step value

Sets the step size for changing the value of the rightmost digit of the measurement value.

→ P.5-80

X V S H

Temperature input shift

Shifts the temperature input value.

→ P.5-24

H

Key operations

Teaching

During scaling, the input value during measurement can be set, as is, as the scaling input value.

→ P.5-14
(Setting Scaling)



Key protection

Limits key-operated level and parameter changes to prevent inadvertent key operations and malfunctions.

→ P.5-102

Outputs

Comparative output pattern

The comparative output pattern can be selected as standard output, zone output, and level output.

→ P.5-44



Hysteresis

Prevents comparative output chattering when the measurement value fluctuates slightly near the set value.

→ P.5-46



Output refresh stop

Holds the output status when comparative results outputs other than PASS turn ON.

→ P.5-52



PASS output change

Comparative results other than PASS and error signals can be output from the PASS output terminal.

→ P.5-57



Output OFF delay

Connects the comparative output OFF timing for a set interval. Comparative output ON times can be held when comparative results change quickly.

→ P.5-55



Shot output

Produces a constant comparative output ON time.

→ P.5-49



Output logic

Reverses the output logic of comparative outputs for comparative results.

→ P.5-59



Startup compensation timer

Constant-time measurements can be stopped by an external signal input.

→ P.5-27



Output test

Output operation can be confirmed without actual input signals, by setting test measurement values using the keys.

→ P.5-90



Linear output

Outputs currents or voltages proportional to measurement values as they change.

→ P.5-65



Standby sequence

Turns the comparative output OFF until the measurement value enters the PASS range.

→ P.5-61



Display

Display value selection

The current display value can be selected from the present value, the maximum value, and the minimum value.

→ P.5-78

X V S H

Display color selection

The PV display color can be set to either green or red. The present value color can be switched according to the status of comparative outputs.

→ P.5-83

X V S H

Display refresh period

When inputs change quickly, the display refresh period can be delayed to reduce flickering and make the display easier to read.

→ P.5-73

X V S H

Position meter

Displays the current measurement value as a position in relation to the scaling width on a meter with 20 sections.

→ P.5-85

X V S H

Scaling

Can convert the input signal to any display value.

→ P.5-14

X V S

Comparative set value display

The comparative set value can be set to not display during operation.

→ P.5-82

X V S H

Decimal point display

Disables displaying numerals the decimal point in measurement values.

→ P.5-93

H

Other

Max/Min hold

Holds the maximum and minimum measurement values.

→ P.5-54

X V S H

Bank selection

Eight comparative set value banks can be selected using the keys on the front of the Unit or by external inputs. Groups of comparative set values can be set and can be selected as groups.

→ P.5-93

X V S H

Bank copy

Any bank setting can be copied to all banks.

→ P.5-98

X V S H

Cold junction compensation

Enables or disables terminal temperature compensation.

→ P.5-31

H

User calibration

Allows the user to calibrate the K3HB.

→ P.6-1

X V S H

Power interruption memory

Enables recording the maximum and minimum values when power is interrupted.

→ P.5-75

X V S H

1.2 Component Names and Functions

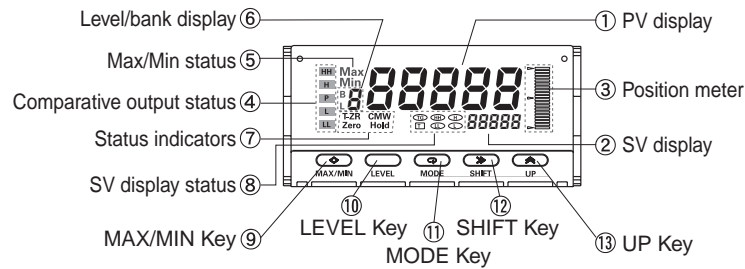

No.	Name	Function
①	PV display	Displays PVs, maximum values, minimum values, parameter names, and error names.
②	SV display	Displays SVs and monitor values.
③	Position meter	Displays the position of the PV with respect to a desired scale.
④	Comparative output status indicators	Display the status of comparative outputs.
⑤	Max/Min status indicator	Turns ON when the maximum value or minimum value is displayed in the RUN level.
⑥	Level/bank display	In RUN level, displays the bank if the bank function is ON. (Turns OFF if the bank function is OFF.) In other levels, displays the current level.
⑦	Status indicators	T-ZR: Turns ON when the tare zero function is executed. Turns OFF if it is not executed or is cleared. Zero: Turns ON when the forced-zero function is executed. Turns OFF if it is not executed or is cleared. (Excluding the K3HB-H.) Hold: Turns ON/OFF when hold input turns ON/OFF.
⑧	SV display status indicators	TG: Turns ON when the timing signal turns ON. Otherwise OFF. T: Turns ON when parameters for which teaching can be performed are displayed. HH, H, L, LL: In RUN level, turn ON when the comparative set values HH, H, L, and LL are displayed.
⑨	MAX/MIN Key	Used to switch the display between the PV, maximum value, and minimum value and to reset the maximum and minimum values.
⑩	LEVEL Key	Used to switch level.
⑪	MODE Key	Used to switch the parameters displayed.
⑫	SHIFT Key	Used to change parameter settings. When changing a set value, this key is used to move along the digits.
⑬	UP Key	When changing a set value, this key is used to change the actual value. When a measurement value is displayed, this key is used to execute or clear the forced-zero function or to execute teaching.

1.3 Internal Block Diagram

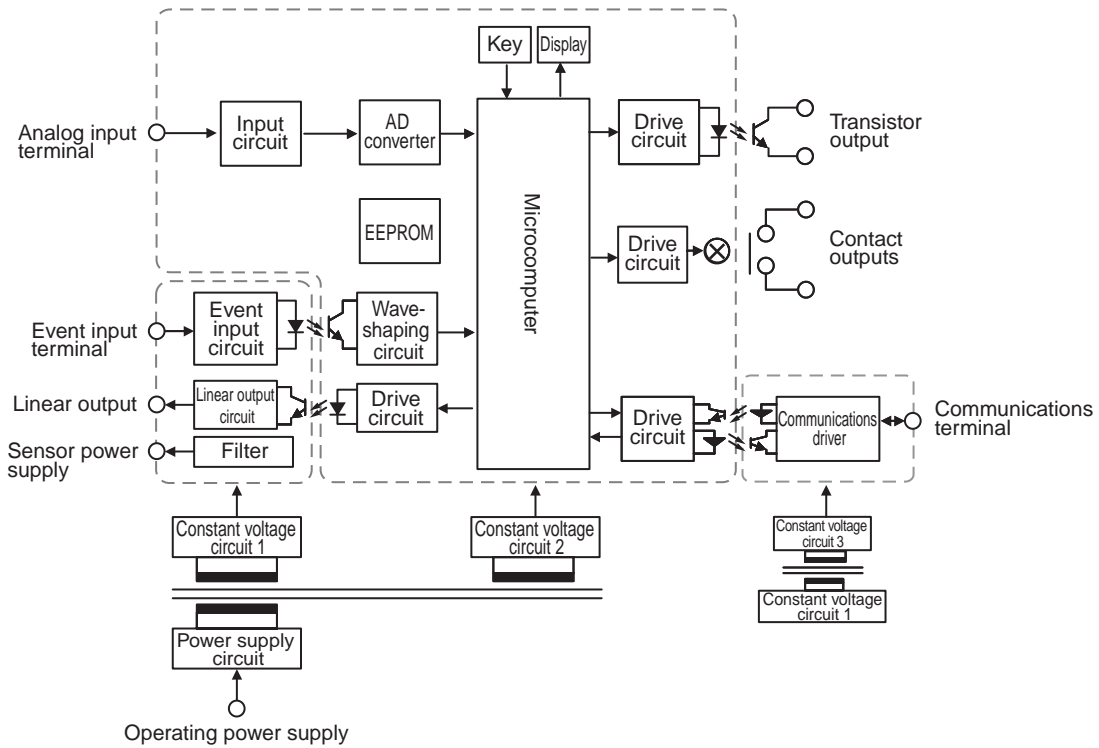

Section 2 Preparations

2.1	Mounting	2-2
2.2	Using I/O	2-4

2.1 Mounting

External Dimensions

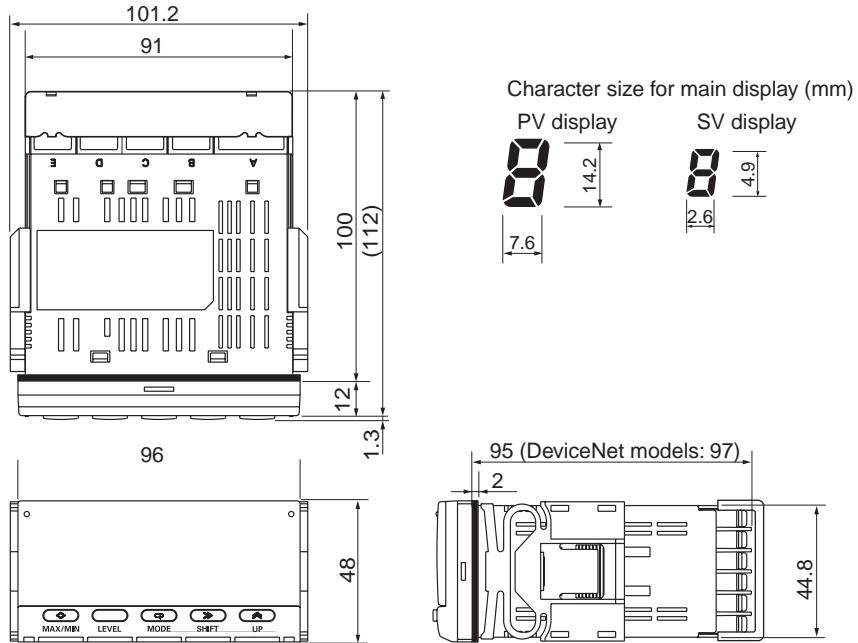

Panel Cutout Dimensions

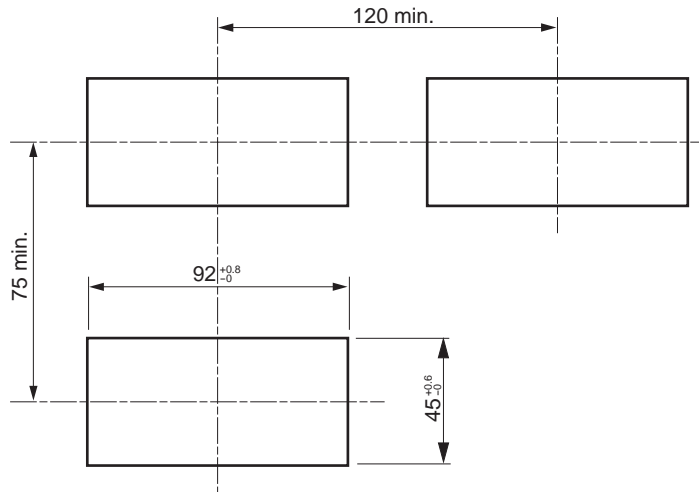

■ Mounting Method

- (1) Insert the K3HB into the mounting cutout in the panel.
- (2) Insert watertight packing around the Unit to make the mounting watertight.

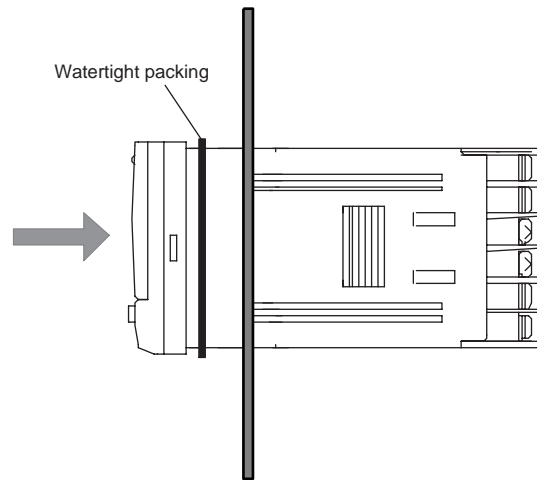

- (3) Insert the adapter into the grooves on the left and right sides of the rear case and push until it reaches the panel and is fixed in place.

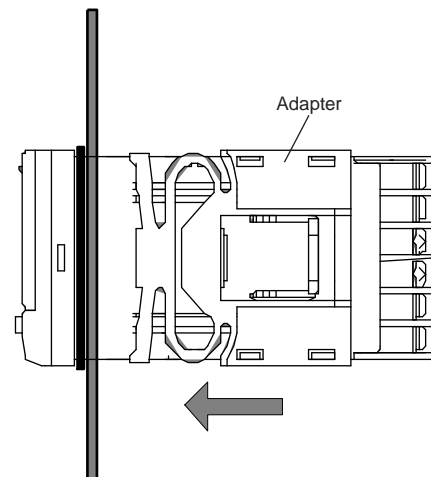

■ LCD Field of Vision

The K3HB is designed to have the best visibility at the angles shown in the following diagram.

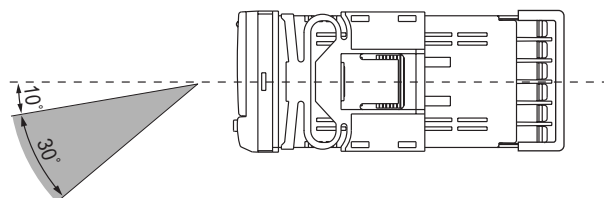

2.2 Using I/O

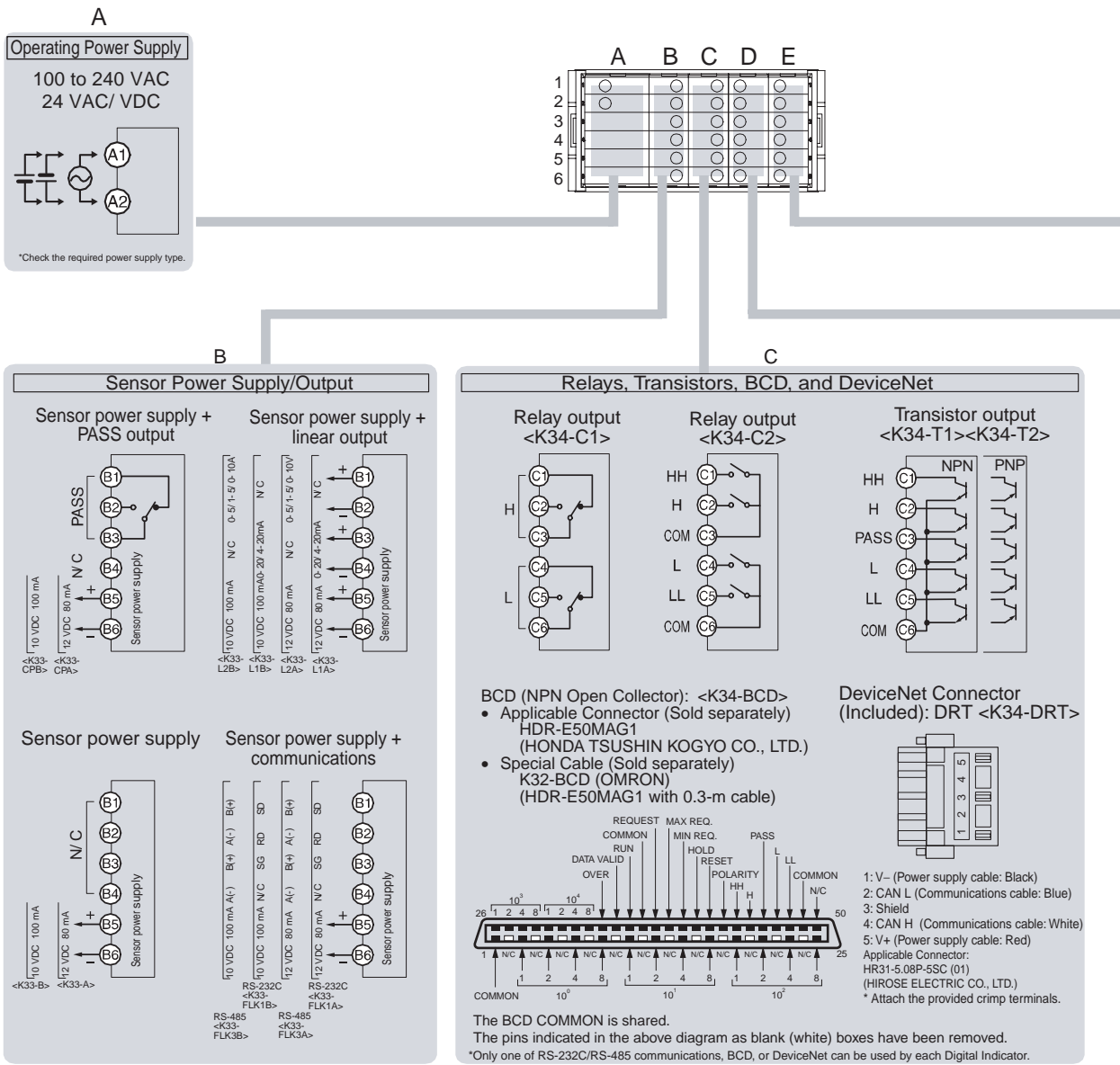

BCD Output Cable

Model	Shape	Pin arrangement
K32-BCD	<p>Cover: HDR-E50LPA5 (manufactured by Honda Tsushin Co., Ltd) Connector: HDR-E50MAG1 (manufactured by Honda Tsushin Co., Ltd)</p> <p>D-sub connector (37-pin female) Cover: 17JE-37H-1A (manufactured by DDK) Connector: Equivalent to 17JE-13370-02 (manufactured by DDK) Stand: 17L-002A (manufactured by DDK)</p>	

Note: The BCD Output Cable has a D-sub plug. Cover: 17JE-37H-1A (manufactured by DDK); Connector: equivalent to 17JE-23370-02 (D1) (manufactured by DDK)

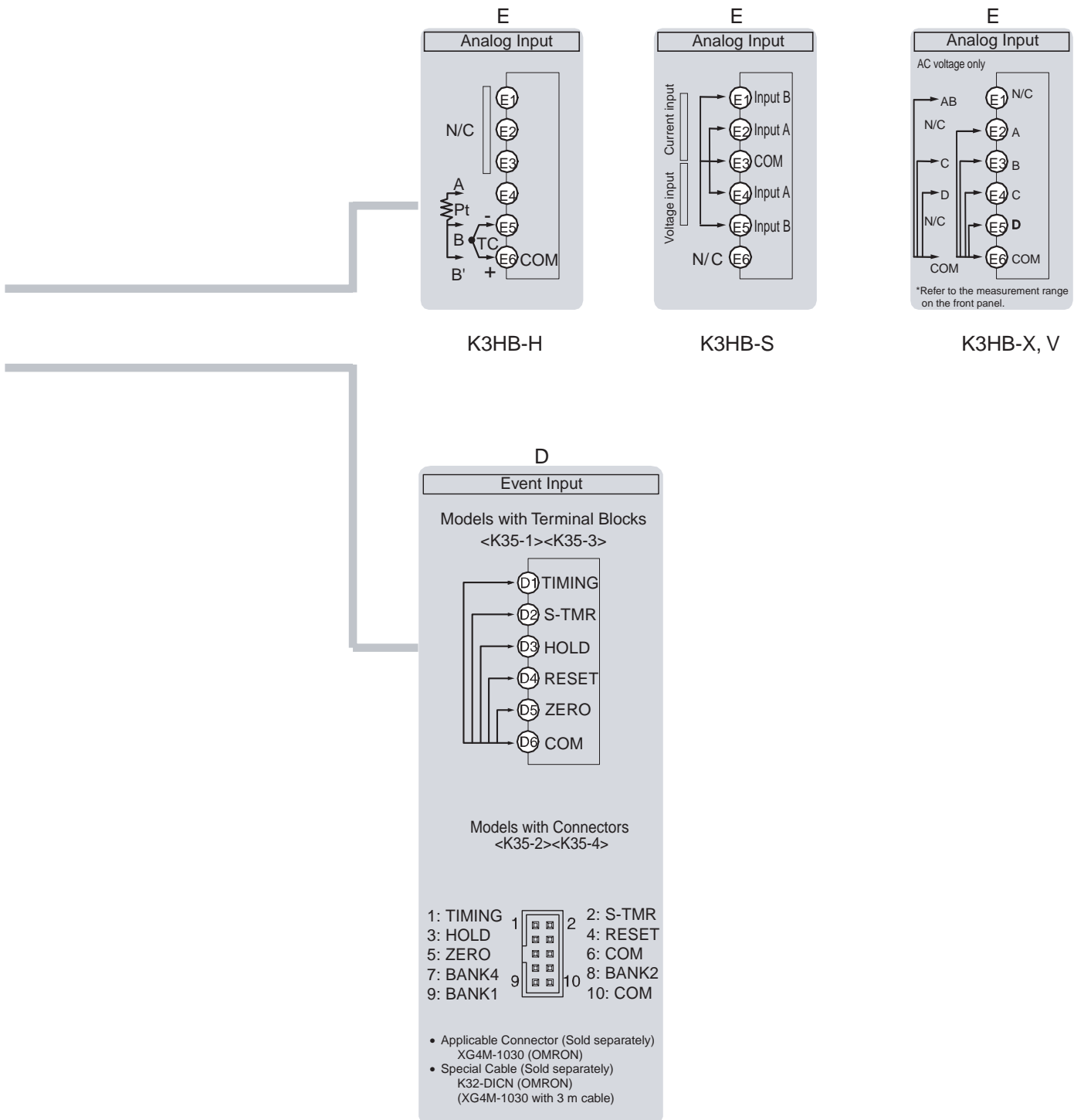

Special Cable (for Event Inputs with 8-pin Connector)

Model	Appearance	Wiring																						
K32-DICN		<table border="1"> <thead> <tr> <th>Pin No.</th> <th>Signal name</th> </tr> </thead> <tbody> <tr><td>1</td><td>N/C</td></tr> <tr><td>2</td><td>S-TMR</td></tr> <tr><td>3</td><td>HOLD</td></tr> <tr><td>4</td><td>RESET</td></tr> <tr><td>5</td><td>N/C</td></tr> <tr><td>6</td><td>COM</td></tr> <tr><td>7</td><td>BANK4</td></tr> <tr><td>8</td><td>BANK2</td></tr> <tr><td>9</td><td>BANK1</td></tr> <tr><td>10</td><td>COM</td></tr> </tbody> </table>	Pin No.	Signal name	1	N/C	2	S-TMR	3	HOLD	4	RESET	5	N/C	6	COM	7	BANK4	8	BANK2	9	BANK1	10	COM
Pin No.	Signal name																							
1	N/C																							
2	S-TMR																							
3	HOLD																							
4	RESET																							
5	N/C																							
6	COM																							
7	BANK4																							
8	BANK2																							
9	BANK1																							
10	COM																							

■ Wiring

Use crimp terminals suitable for M3 screws, as shown below.

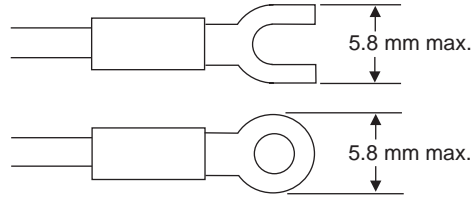

Use cables with a heat resistance of at least 70°C.

● Power Supply

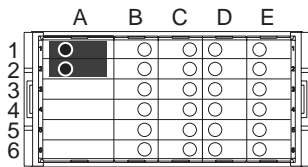

Supply power to terminal numbers A1 and A2. The power supply specifications are outlined below.

100 to 240 VAC, 50/60 Hz, 18 VA max. (at max. load)

24 VAC/VDC, 50/60 Hz, 12 VA max./7 W max. (at max. load)

(No polarity)

When the power is turned ON, a power supply capacity greater than the rated power supply is required. When multiple Units are being used, make sure that the operating power supply has sufficient capacity.

Complying with UL/CSA Standards

Use an SELV power supply with overcurrent protection for the DC power supply. An SELV power supply has double or reinforced insulation between the input and output, an output voltage of 30 V rms and 42.4 V peak, and is 60 VDC or less.

Recommended Power Supply: S8VS-06024□ (from OMRON)

● Sensor Power Supply

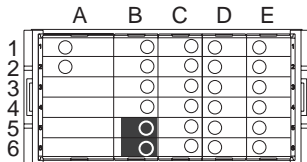

The sensor power can be supplied from terminals B5 and B6. The power supply specifications are outlined below.

12 VDC 80 mA ⓅB5 → +

or

10 VDC 100 mA ⓅB6 → -

● Linear Output

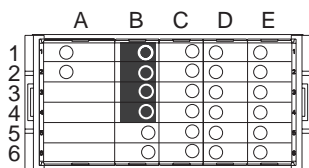

Linear currents and voltages are output between terminals B1 to B2 and between B3 to B4.

Connect a load within the specified range.

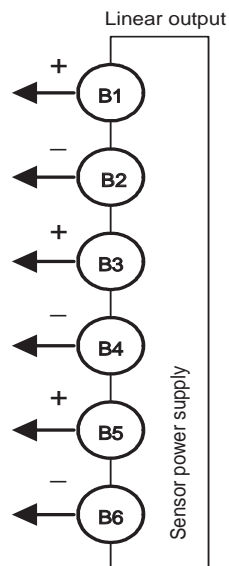

Circuit Diagrams

Linear voltage output

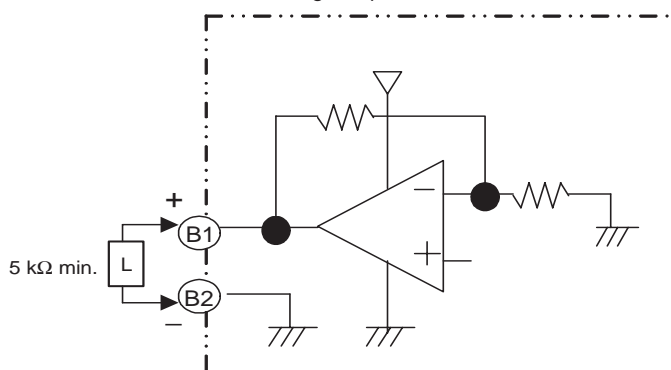

Linear current output

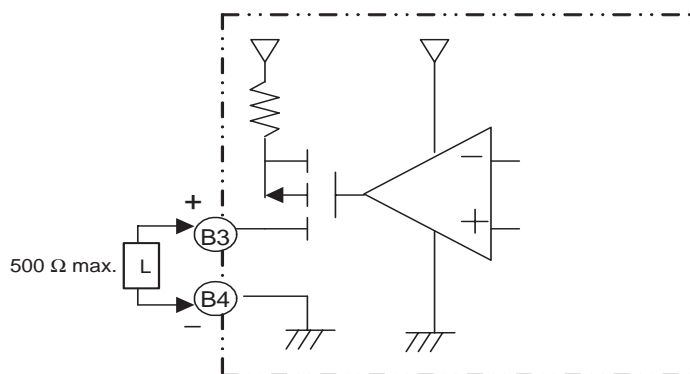

● Comparative Outputs

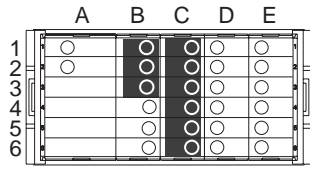

Comparative outputs are output to terminals B1 to B3 and C1 to C6.

Connect loads within specifications.

The electrical life expectancy of the relays is 100,000 operations.

Circuit Diagrams

Contact Outputs

<K34-C1> H and L Output Models

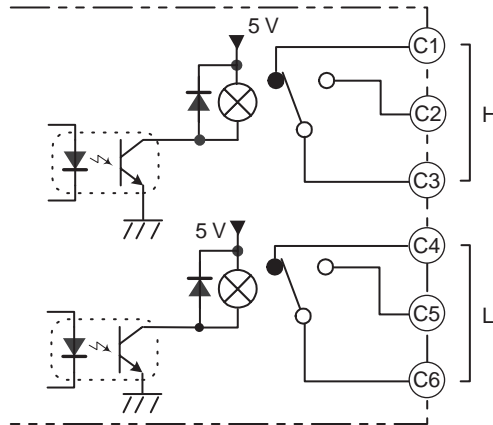

<K34-C2> HH, H, L, and LL Output Models

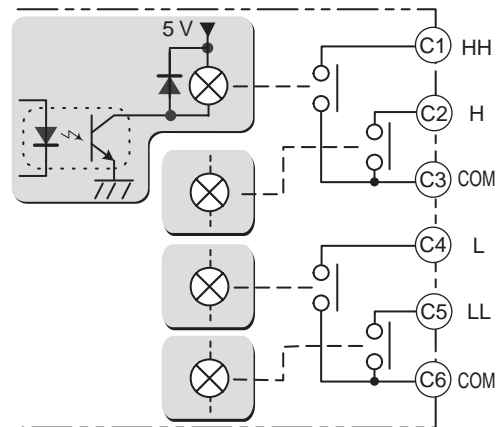

<K34-CPA> PASS Output Models

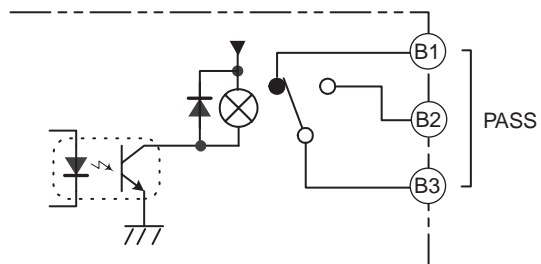

Transistor Outputs

<K34-T1> NPN Output Models

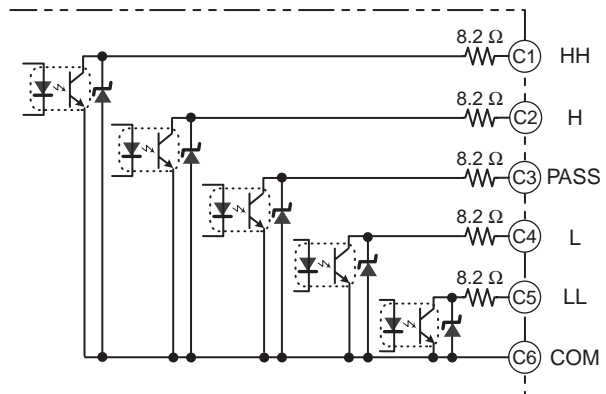

<K34-T2> PNP Output Models

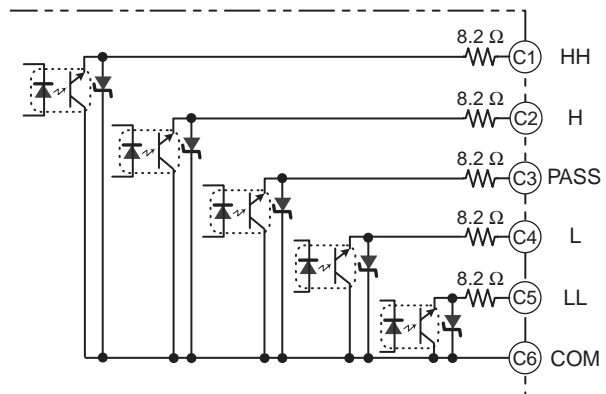

● Event Inputs

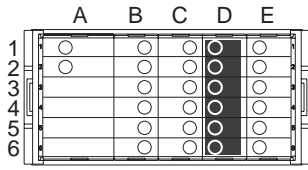

Input control signals. The configuration is shown below.

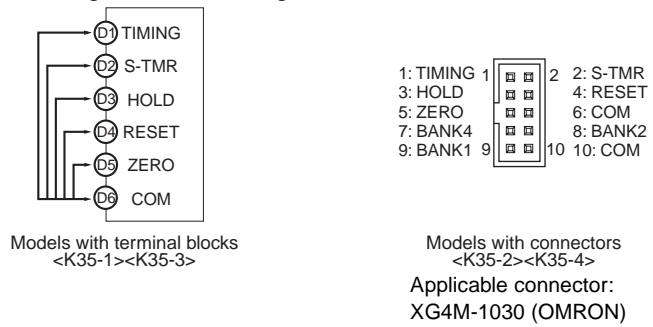

Circuit Diagrams

<K35-1><K35-2> NPN Input Models

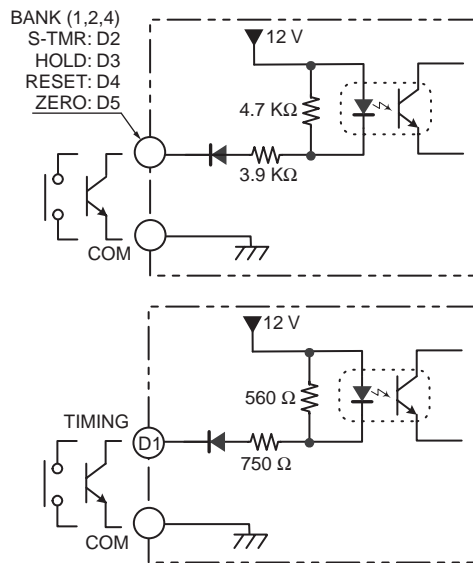

<K35-3><K35-4> PNP Input Models

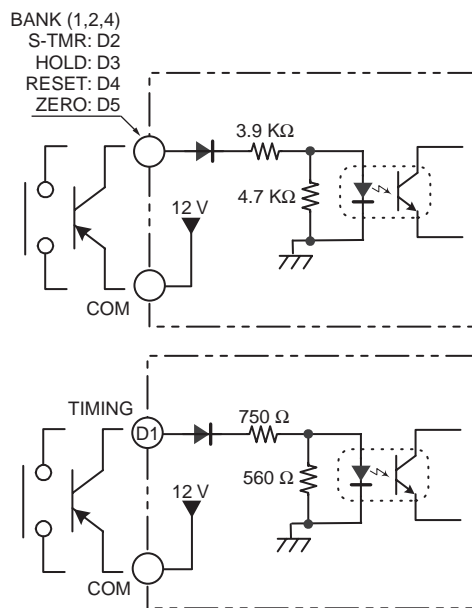

● **K3HB-X:**
DC Voltage,
DC Current,
AC Voltage, or
AC Current Input

Input the signal to be measured. The following figure shows the inputs that can be measured by each model. Connect the input devices to the terminals shown below according to the input type.

Make sure that the allowable instantaneous overload is not exceeded, even momentarily.

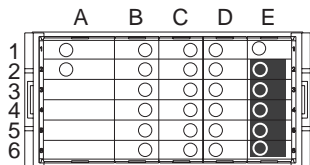

(AC voltage only)

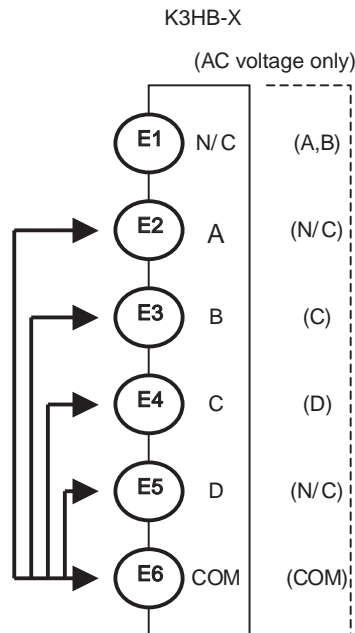

Circuit Diagram

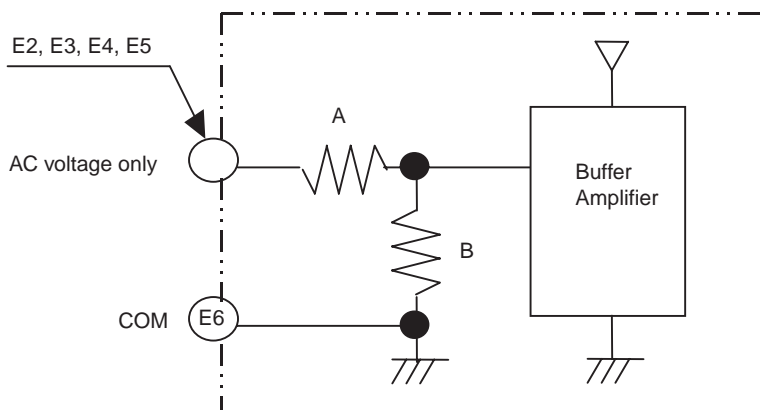

Input type	Input range		Maximum measurement range	Terminal No.	Input impedance (A+B)
DC voltage	A	±199.99 V	-199.99 to 219.99 V	E2	10 MΩ min.
	B	±19.999 V	-19.999 to 21.999 V	E3	1 MΩ min.
	C	±1.9999 V	-1.9999 to 2.1999 V	E4	
	D	1.0000 to 5.0000 V	0.5000 to 5.5000 V	E5	
DC current	A	±199.99 mA	-199.99 to 219.99 mA	E2	1 Ω max.
	B	±19.999 mA	-19.999 to 21.999 mA	E3	10 Ω max.
	C	±1.9999 mA	-1.9999 to 2.1999 mA	E4	33 Ω max.
	D	4.000 to 20.000 mA	2.000 to 22.000 mA	E5	10 Ω max.
AC voltage	A	0.0 to 400.0 V	0.0 to 440.0 V	E1	1 MΩ min.
	B	0.00 to 199.99 V	0.00 to 219.99 V	E1	
	C	0.000 to 19.999 V	0.000 to 21.999 V	E3	
	D	0.0000 to 1.9999 V	0.0000 to 1.9999 V	E4	
AC current	A	0.000 to 10.000 V	0.000 to 11.000 V	E2	0.5 VA CT
	B	0.0000 to 1.9999 V	0.0000 to 2.1999 V	E3	1 Ω max.
	C	0.00 to 199.99 mA	0.00 to 219.99 mA	E4	
	D	0.000 to 19.999 mA	0.000 to 21.999 mA	E5	10 Ω max.

● **K3HB-V:**
mV, Load Cell Input



Input the signal to be measured. The following figure shows the inputs that can be measured by each model. Connect the input devices to the terminals shown below according to the input type.

Make sure that the allowable instantaneous overload is not exceeded, even momentarily.

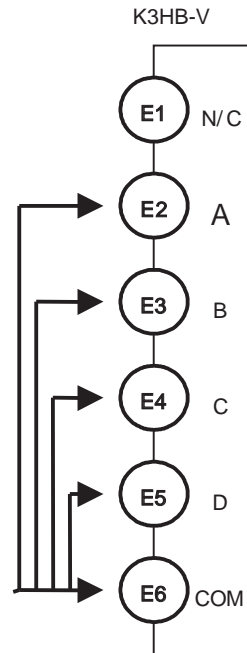

Circuit Diagram

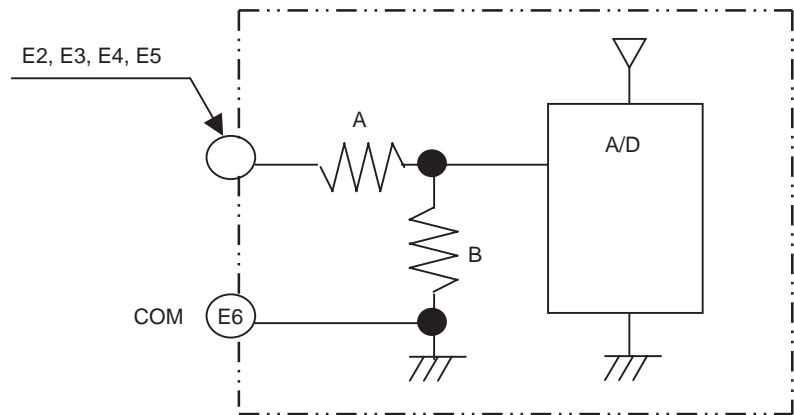

mV, Load cell input	Input range	Maximum measurement range	Terminal No.	Input impedance (A+B)
A	0.00 to 199.99 mV	-19.99 to 219.99 mV	E2	1 MΩ min.
B	0.000 to 19.999 mV	-19.999 to 21.999 mV	E3	
C	±100.00 mV	-110.00 to 110.00 mV	E4	
D	±199.99 mV	-199.99 to 219.99 mV	E5	

● **K3HB-S:**
Analog Input



Input the signal to be measured. The inputs that can be measured by each model are as follows: Voltage/Current Inputs. Connect the input devices to the terminals shown below according to the input type. Make sure that the absolute maximum rating is not exceeded, even momentarily.

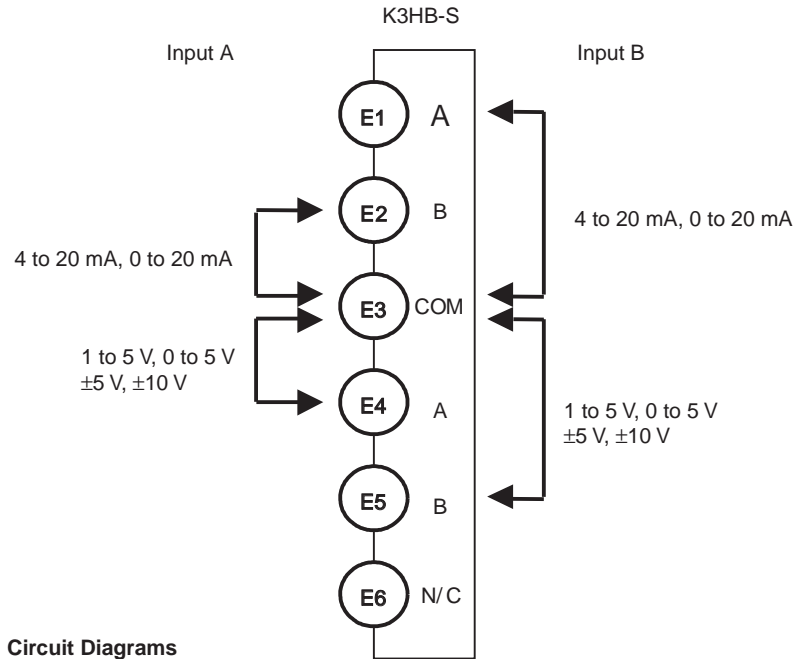

Circuit Diagrams

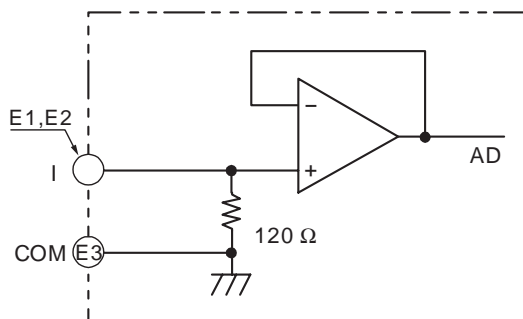
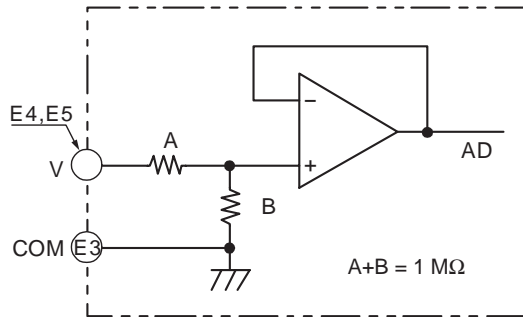

● K3HB-H: Temperature Input



Input the signal to be measured. The following figure shows the inputs that can be measured by each model. Connect the input devices to the terminals shown below according to the input type.

Make sure that the absolute maximum rating is not exceeded, even momentarily.

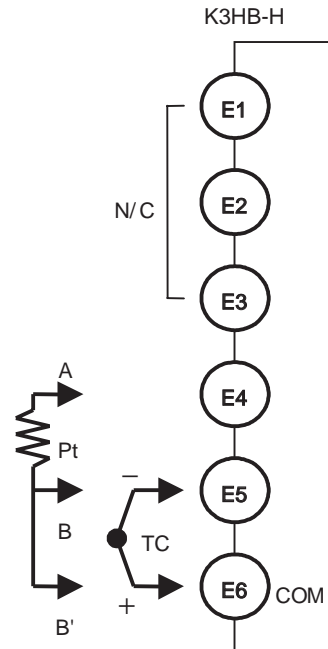

Section 3 *Basic Application Methods*

3.1	Monitoring Tank Levels	3-2
3.2	Monitoring Motor Load Current.....	3-6
3.3	Weighing Material	3-9
3.4	Temperature Monitoring/Control with Multi-level Output	3-11
3.5	Product Height Measurement and OK/NG Judgement.....	3-14
3.6	Panel Thickness Inspection	3-17
3.7	Measurement of Disk Eccentricity	3-20
3.8	Step Inspection	3-22

3.1 Monitoring Tank Levels

Advantages of Using the K3HB-X

- The tank level can be monitored
- The distance to the surface of the liquid can be detected using an E4PA-LS400-M1 Ultrasonic Displacement Sensor (Sonic Displacement Sensor).
- The liquid volume can be displayed on the K3HB-X to indicate volume in liters (□□ l). The tank level can also be shown using the 20-section display on the position meter (provides a full-scale level display).
- The number of measurements to be averaged (averaging times) can be set to 4 to ensure stable readings of levels in relation to full scale.
- Comparative outputs can be generated for tank volume on four levels: dry tank alarm, lower limit alarm, upper limit alarm, and full tank alarm.
- The display can be forcibly shifted to 0 for readings less than zero or readings outside the detection range of the Ultrasonic Displacement Sensor.

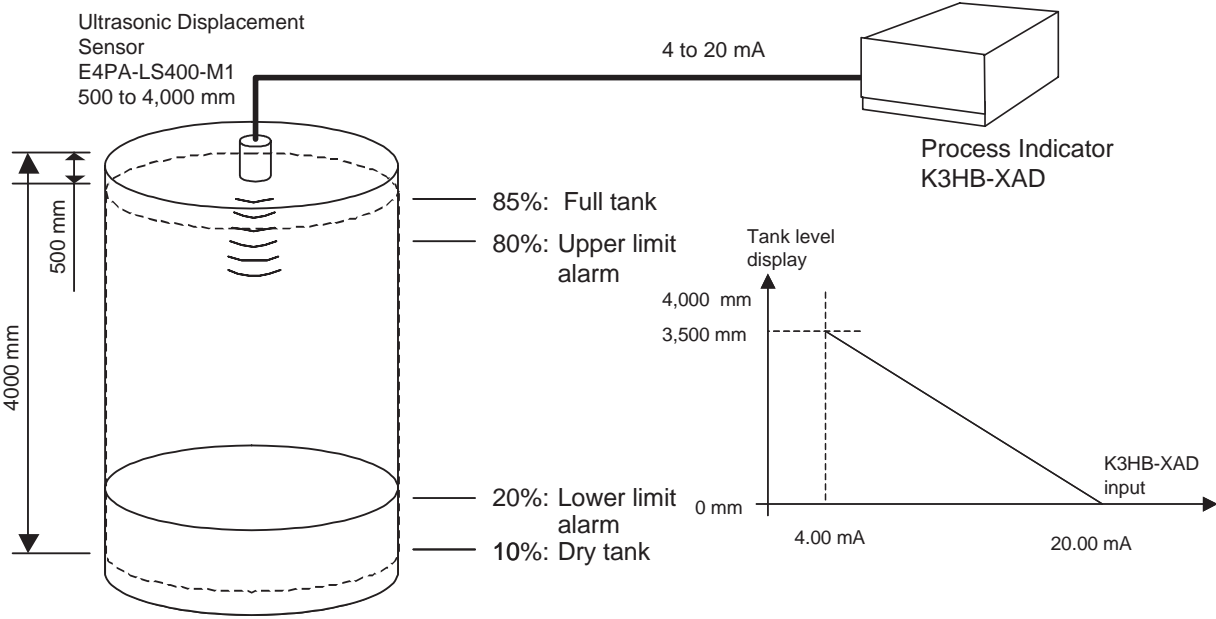

Connections Diagram

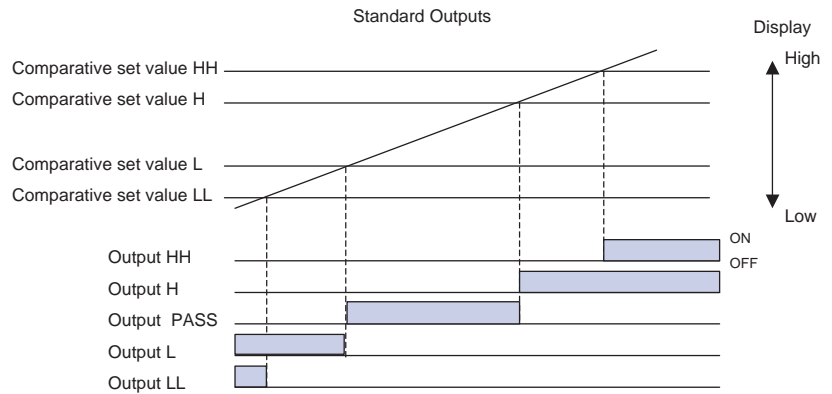
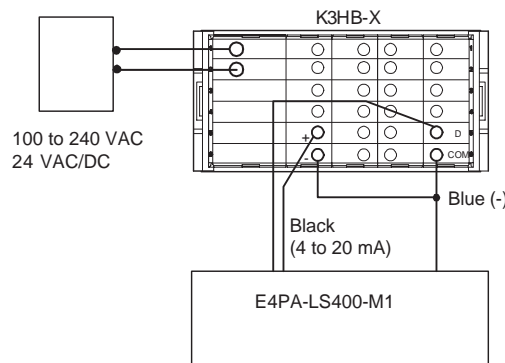

RUN Level

Parameter	Characters	Set value	Remarks
Comparative set value HH	*	3400	Control example for the following settings: Full tank alarm set: 3,400 mm Upper limit alarm: 3,200 mm Lower limit alarm: 800 mm Dry tank alarm: 400 mm
Comparative set value H	*	3200	
Comparative set value L	*	800	
Comparative set value LL	*	400	

* Check on the status displays.

Initial Setting Level (L 0)

Parameter	Characters	Set value	Remarks
Input type A	Ln-tA	d Ad	<p>Measurement distance</p> <p>3.500 mm</p> <p>0 mm</p> <p>4.00 mA</p> <p>20.00 mA</p> <p>Output</p> <p>E4PA-LS400-M1</p>
Scaling input value A1	LnP.R1	4.00	
Scaling display value A1	dSP.R1	3500	
Scaling input value A2	LnP.R2	20.000	
Scaling display value A2	dSP.R2	0	
Decimal point position	dP	000000	
Comparative output pattern	oUt-P	noñRL	

Input Adjustment Level (L i)

Parameter	Characters	Set value	Remarks
Timing hold	tñL-H	noñRL	Normal
Zero-limit	z-Lñ	0n	Enables the zero-limit function.
Zero-limit value	Lñ-P	0	Displays 0 for values less than zero.
Averaging type	AvL-t	ñ0uE	Moving average
Averaging times	AvL-n	4	4

Display Adjustment Level (L2)

Parameter	Characters	Set value	Remarks
Display value selection	<i>dLSP</i>	<i>Pu</i>	Present value
Position meter type	<i>POS-t</i>	<i>inc</i>	Incremental display
Position meter upper limit	<i>POS-H</i>	<i>4000</i>	Full-scale 0.0 to 4,000 mm
Position meter lower limit	<i>POS-L</i>	<i>0</i>	

* Other parameters are set to their default values.

3.2 Monitoring Motor Load Current

Advantages of Using the K3HB-X

- The motor load current can be monitored and the measurement value and output status held when the motor is tripped. The K3HB-X will hold this status even if a power interruption occurs.
- A 75:5 current transformer (CT) can be used for motor current detection.
- Up to 10 A can be input directly using the K3HB-XAA.
- Current can be displayed in amperes (A) up to two digits past the decimal point (□□.□□ A) on the K3HB-XAA.
- Two-level output detection can be used for the upper limit.
- The startup compensation timer on the K3HB-XAA can be set to prohibit measurements for a certain amount of time after the motor startup signal is received to prevent judgments that result in inadvertent output due to inrush current measured when the motor starts.
- The startup compensation timer is set to 10 s.
- An output is generated when the H and L values exceed the comparative output settings. (Uses two-level detection for the upper limit.)

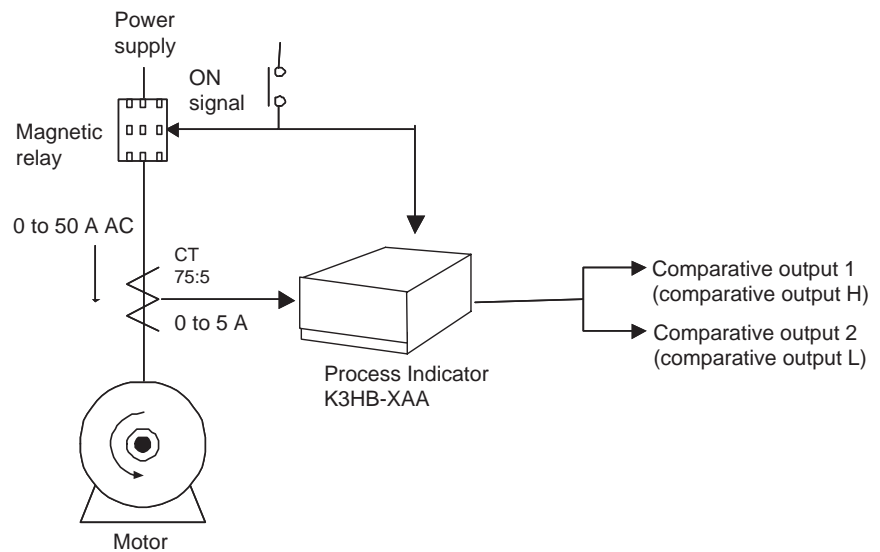

Connections Diagram

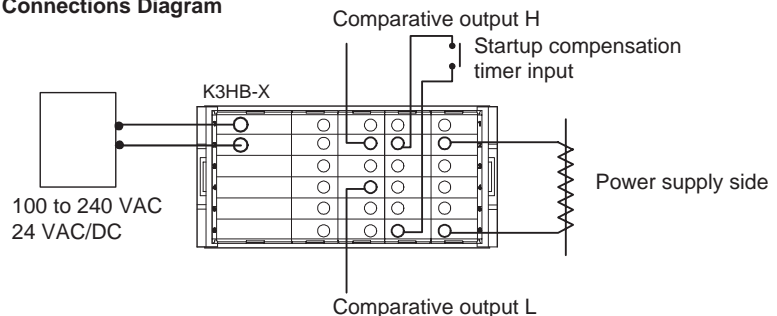

- Comparative set value H is 50.00 A and comparative set value L is 40.00 A.

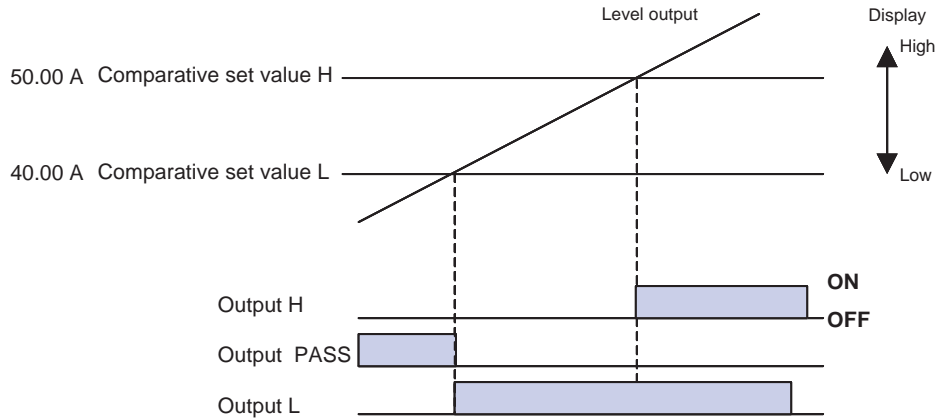

RUN Level

Parameter	Characters	Set value	Remarks
Comparative set value H	*	50.00	Control example for the following settings: Comparative output 1: 50.00 A Comparative output 2: 40.00 A
Comparative set value L	*	40.00	

* Check on the status displays.

Initial Setting Level (L 0)

The Setting Level Protect setting must be set to 0 (SET.PT = 0) to enable moving to the advanced function setting level.

Parameter	Characters	Set value	Remarks
Input type A	IN-TR	R RR	
Scaling input value A1	INP.R1	0.000	
Scaling display value A1	dSP.R1	0	
Scaling input value A2	INP.R2	5.000	
Scaling display value A2	dSP.R2	7500	
Decimal point position	dP	000.00	
Comparative output pattern	OUT-P	LEVEL	Level output
Move to advanced function setting level	RNDW	-0 169	Move to advanced function setting level to set the startup compensation timer

Advanced Function Setting Level (L F)

Parameter	Characters	Set value	Remarks
Startup compensation timer	S-t \bar{r}	10.0	Set the startup compensation timer at motor startup to 10 s.

Input Adjustment Level (L i)

Parameter	Characters	Set value	Remarks
Timing hold	t \bar{h} -H	n \bar{o} \bar{r} \bar{m} \bar{a} \bar{l}	Normal

Display Adjustment Level (L Z)

Parameter	Characters	Set value	Remarks
Display value selection	d \bar{v} S \bar{P}	P \bar{u}	Present value

* Other parameters are set to their default values.

3.3 Weighing Material

Advantages of Using the K3HB-V

- Resin can be weighed
- A load-cell sensor is used to detect the weight of resin. (For example, 0 to 100 kg can be displayed with a rated load cell specification of 100 kg, recommended applied voltage of 10 V and rated output of 2 mV/V.)
- *Here, 2 mV/V means the load cell outputs 2 mV with 1 V applied at the rated load (100-kg weight in this case). With 10 V applied, the load cell output is 20 mV (= 2 mV x 10).
- The weight of the resin is displayed on the K3HB-VLC in kilograms (□□.□ kg).
- The weight of the resin is displayed using the 20-section display on the position meter (provides a full-scale level display).
- The number of measurements to be averaged (averaging times) can be set to 4 to ensure stable readings of levels in relation to full scale.
- The rightmost digit on the display can be rounded to 0 or 5.
- The weight of the tank can be subtracted to display only the weight of the resin. (A forced-zero function can be used to shift the reading on the display to 0 when the empty tank is on the scale.)

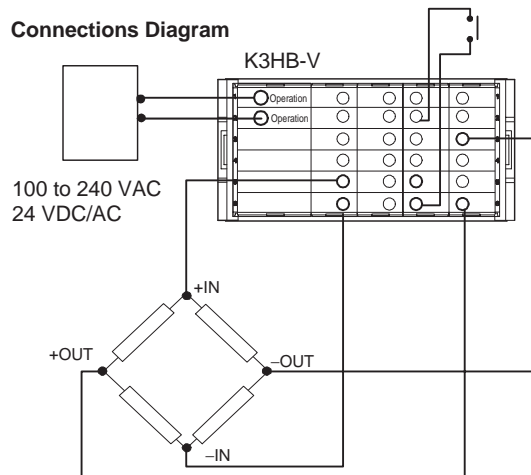
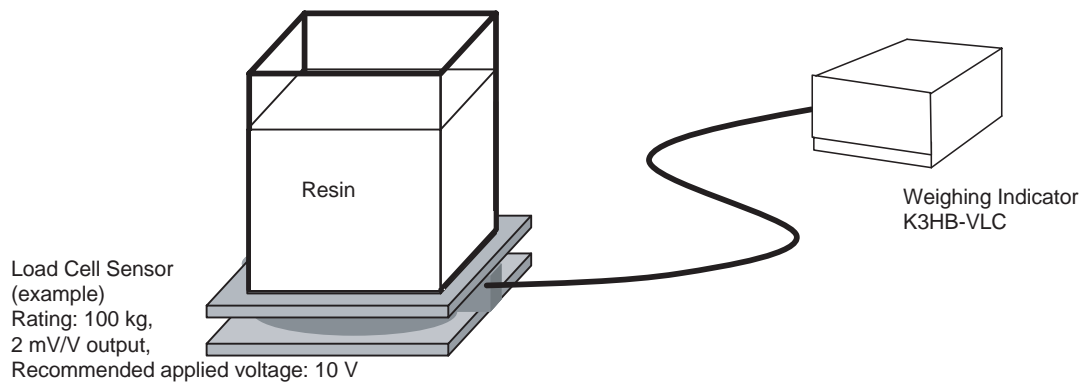

Initial Setting Level (L 0)

Parameter	Characters	Set value	Remarks
Input type A	IN-TR	b LC	
Scaling input value A1	INP.R1	0.000	
Scaling display value A1	dSP.R1	0	
Scaling input value A2	INP.R2	20.000	
Scaling display value A2	dSP.R2	1000	
Decimal point position	dP	0000.0	

Input Adjustment Level (L 1)

Parameter	Characters	Set value	Remarks
Timing hold	TRH-H	normal	Normal
Zero-limit	Z-L	on	Enables the zero-limit function.
Zero-limit value	Z-L-P	0	Displays 0 for values less than zero.
Step value	STEP	5	Rightmost digit will change from 0 to 5 to 0, etc.
Averaging type	AVG-T	MA	Moving average
Averaging times	AVG-N	4	4

Display Adjustment Level (L 2)

Parameter	Characters	Set value	Remarks
Display value selection	dSP	PU	Present value
Position meter type	POS-T	INC	Incremental display
Position meter upper limit	POS-H	1000	Full-scale 0.0 to 100.0 kg
Position meter lower limit	POS-L	0	

* Other parameters are set to their default values.

3.4 Temperature Monitoring/Control with Multi-level Output

Advantages of Using the K3HB-H

- The temperature inside the furnace can be monitored and multi-level judgment outputs can be used to perform control outputs according to the temperature inside the furnace.
- The temperature inside the furnace is detected using an E52-PR□C Thermocouple.
- The temperature range of the E52-PR□C is 0 to 1,400°C.
- The temperature is displayed in □□□.□ °C on the K3HB-HTA. (Can display temperature in increments as small as 0.1°C.)
- The furnace temperature can be displayed using the 20-section display on the position meter (provides a full-scale level display).
- Comparative output HH turns ON when the furnace is 1,000°C or higher. Comparative output H turns ON while the furnace is between 800°C and 1,000°C. Comparative output LL turns ON when the furnace is 200°C or lower. Comparative output L turns ON while the furnace is between 200.1°C and 500°C.
- The standby sequence function disables the comparative output from the time the K3HB-HTA starts until the measurement value reaches the PASS range.

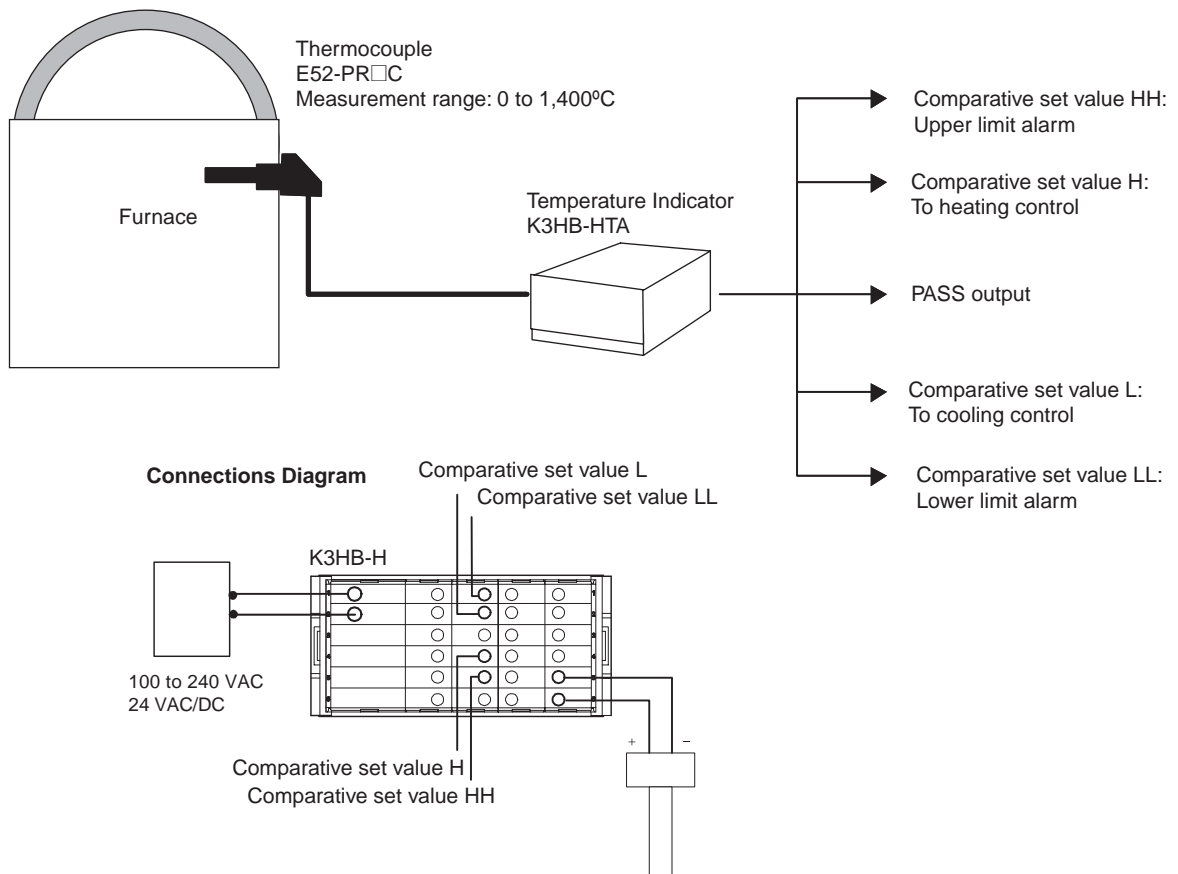

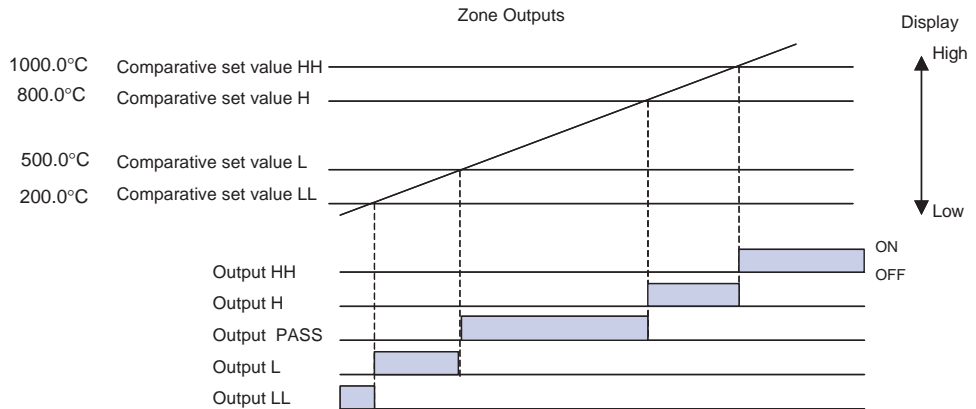

RUN Level

Parameter	Characters	Set value	Remarks
Comparative set value HH	*	1000.0	Control example for the following settings: Upper limit warning: 1,000.0°C Heating output: 800.0°C Cooling output: 500.0°C Lower limit warning: 200.0°C
Comparative set value H	*	800.0	
Comparative set value L	*	500.0	
Comparative set value LL	*	200.0	

* Check on the status displays.

Initial Setting Level (L D)

The Setting Level Protect setting must be set to 0 (SET.PT=0) to enable moving to the advanced function setting level.

Parameter	Characters	Set value	Remarks
Input type A	ĩn-tR	11-r	Set the R thermocouple sensor range.
Temperature unit	d-U	Ĺ	Set the temperature unit to °C.
Comparative output pattern	āũt-P	ĩōnĒ	Zone outputs
Move to advanced function setting level	Rñōũ	-0 159	Move to advanced function setting level to set the standby sequence.

Advanced Function Setting Level (L F)

Parameter	Characters	Set value	Remarks
Standby sequence	ĩt dby	ōn	Enable the standby sequence.

Input Adjustment Level (L 1)

Parameter	Characters	Set value	Remarks
Timing hold	tim-h	normal	Normal

Display Adjustment Level (L 2)

Parameter	Characters	Set value	Remarks
Display value selection	disP	PV	Present value
Position meter type	pos-t	inc	Incremental display
Position meter upper limit	pos-H	1400.0	Full-scale 0.0°C to 1400.0°C
Position meter lower limit	pos-L	0	
Decimal point position	pdP	dot	Display numbers below the decimal point.

* Other parameters are set to their default values.

3.5 Product Height Measurement and OK/NG Judgement

Advantages of Using the K3HB-S

- The sampling hold function can be used together with a sync sensor to display and hold product heights.
- The forced-zero function can be used for one-touch zero adjustment.
- The position meter display can be used to display how far the measurement value deviates from the center.
- The dimensions of molded parts can be checked or caps that are not tight on PET bottles can be detected.

● Checking Dimensions after Press-fitting

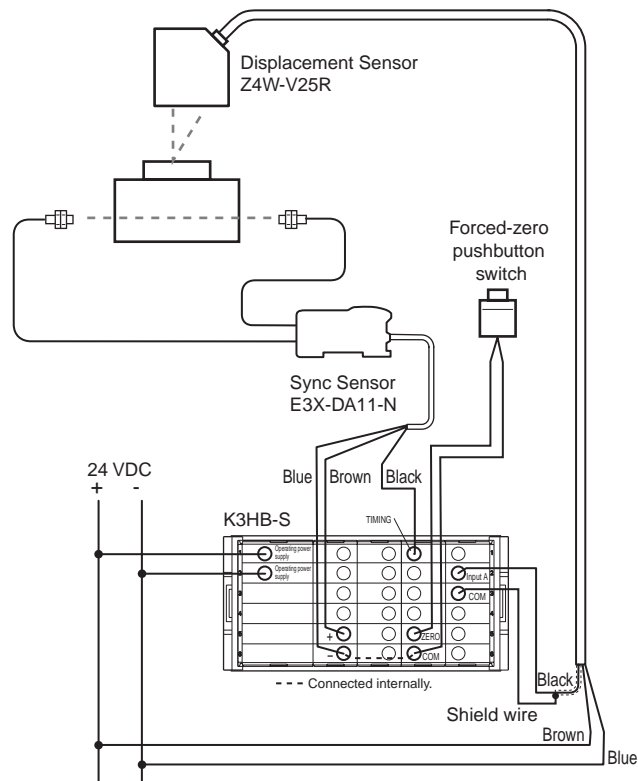
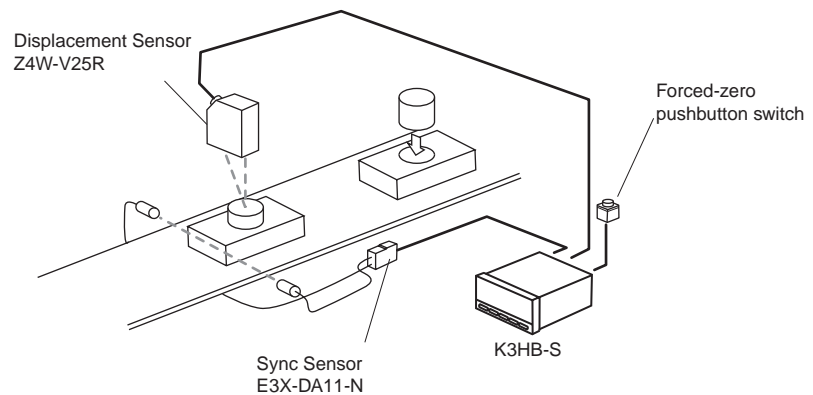

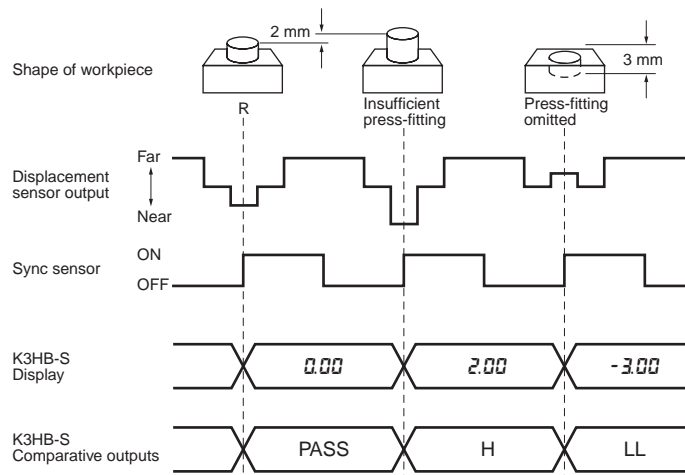

■ K3HB-S Setting Details

RUN Level

Parameter	Characters	Set value	Remarks
Comparative set value HH	*	3.00	Example of monitoring in two stages, at the ± 2 mm and ± 3 mm from the reference.
Comparative set value H	*	2.00	
Comparative set value L	*	-2.00	
Comparative set value LL	*	-3.00	

* Check on the status displays.

Initial Setting Level (L 0)

Parameter	Characters	Set value	Remarks
Calculation	[RL]	0	A
Input type A	[n-tR]	4-20	
Scaling input value A1	[nP.R1]	4.000	
Scaling display value A1	dSP.R1	-4.00	
Scaling input value A2	[nP.R2]	20.000	
Scaling display value A2	dSP.R2	4.00	
Decimal point position	dP	000.00	

Input Adjustment Level (L 1)

Parameter	Characters	Set value	Remarks
Timing hold	[nL-H]	5-H	Sampling hold

Display Adjustment Level (L2)

Parameter	Characters	Set value	Remarks
Position meter type	P \bar{a} S-t	dE \bar{u}	Deviation display
Position meter upper limit	P \bar{a} S-H	4.00	Full-scale ± 4 mm
Position meter lower limit	P \bar{a} S-L	-4.00	

* Other parameters are set to their default values.

3.6 Panel Thickness Inspection

Advantages of Using the K3HB-S

- Calculation mode K-(A+B) can be used to convert panel thickness to actual size and measure it from the outputs of two displacement sensors.
- The forced-zero function can be used for one-touch deviation measurement from a reference panel thickness.

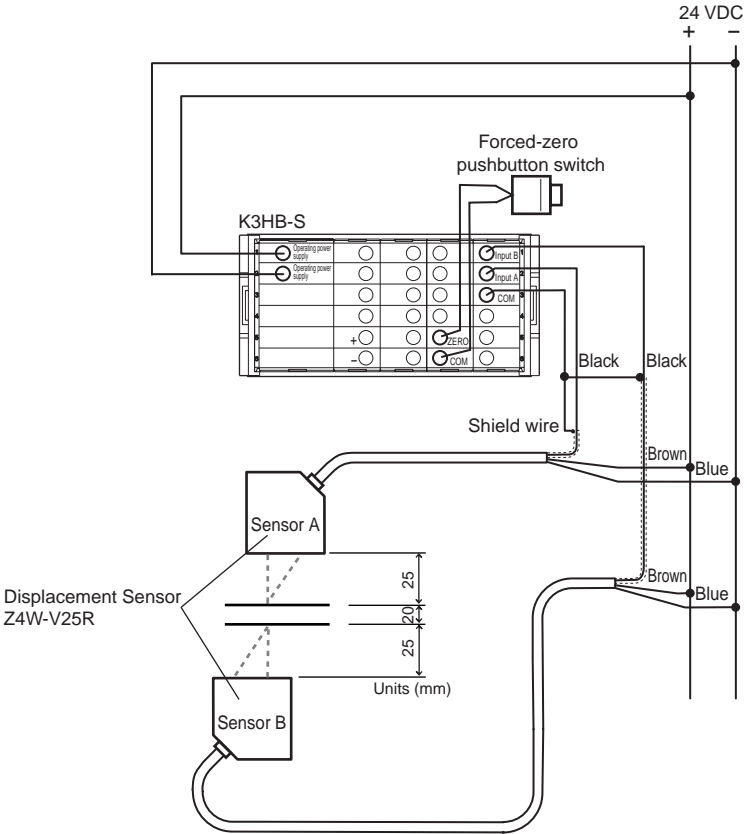
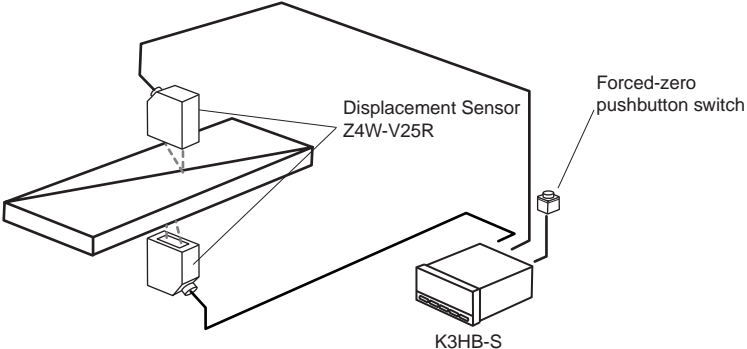

Basic Application Methods

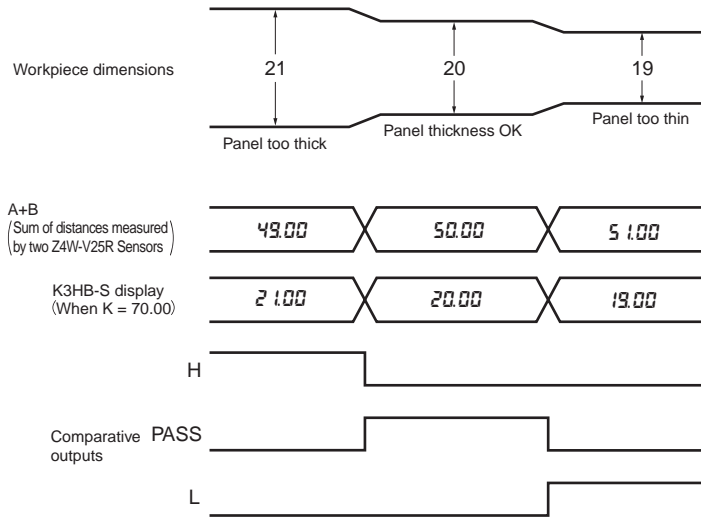

■ K3HB-S Settings Details

RUN Level

Parameter	Characters	Set value	Remarks
Comparative set value H	*	20.50	Monitoring a difference of ±0.5 mm for a reference panel thickness of 20 mm
Comparative set value L	*	19.50	

* Check on the status displays.

Initial Setting Level (L 0)

Parameter	Characters	Set value	Remarks	
Calculation	\overline{CAL}	5	K-(A+B)	
Input type A	$\overline{IN-AR}$	4-20	<p>Z4W-V25R Output (mA)</p> <p>Displacement (mm)</p>	
Scaling input value A1	$\overline{INP.A1}$	4.000		
Scaling display value A1	$\overline{DSP.A1}$	2.100		
Scaling input value A2	$\overline{INP.A2}$	20.000		
Scaling display value A2	$\overline{DSP.A2}$	2900		
Input type B	$\overline{IN-AB}$	4-20		
Scaling input value B1	$\overline{INP.B1}$	4.000		
Scaling display value B1	$\overline{DSP.B1}$	2.100		
Scaling input value B2	$\overline{INP.B2}$	20.000		
Scaling display value B2	$\overline{DSP.B2}$	2900		
Constant K	μ	7000		Reference panel thickness 20 mm + sensor displacement 25 mm \times 2
Decimal point position	\overline{dP}	000.00		

Input Adjustment Level (L 1)

Parameter	Characters	Set value	Remarks
Timing hold	$\overline{THL-H}$	7000	Normal

* Other parameters are set to their default values.

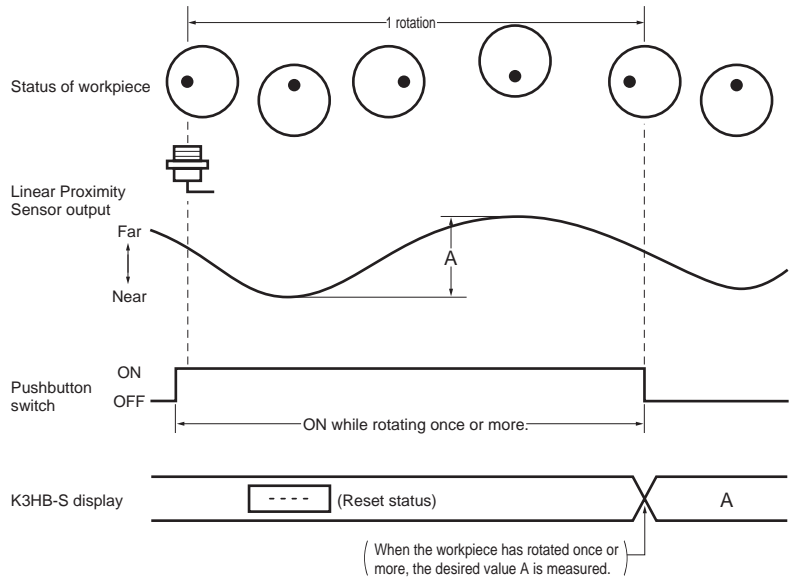

■ K3HB-S Setting Details

Initial Setting Level (L 0)

Parameter	Characters	Set value	Remarks
Calculation	CR	0	A
Input type A	IN-TR	4-20	<p>E2CA Output (mA)</p> <p>20</p> <p>4</p> <p>0.4</p> <p>2</p> <p>Displacement (mm)</p>
Scaling input value A1	INP.R1	4.000	
Scaling display value A1	dSP.R1	0.40	
Scaling input value A2	INP.R2	20.000	
Scaling display value A2	dSP.R2	2.00	
Decimal point position	dP	000.00	

Input Adjustment Level (L 1)

Parameter	Characters	Set value	Remarks
Timing hold	TRG-H	P-P	Peak-to-peak hold

* Other parameters are set to their default values.

3.8 Step Inspection

Advantages of Using the K3HB-S

- Calculation mode A-B can be used to measure steps using two displacement sensors.
- The forced-zero function can be used to easily adjust the reference step dimension to the actual object.
- The effects of carrier line movement can be eliminated using a normal dimensions check to measure the dimensions between the workpiece surface and the carrier line surface.

● Checking Molded Parts Dimensions

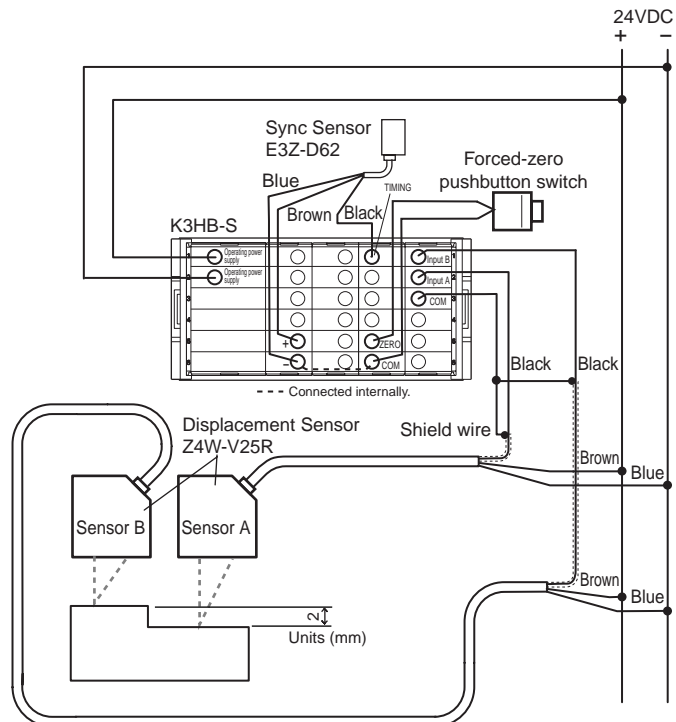
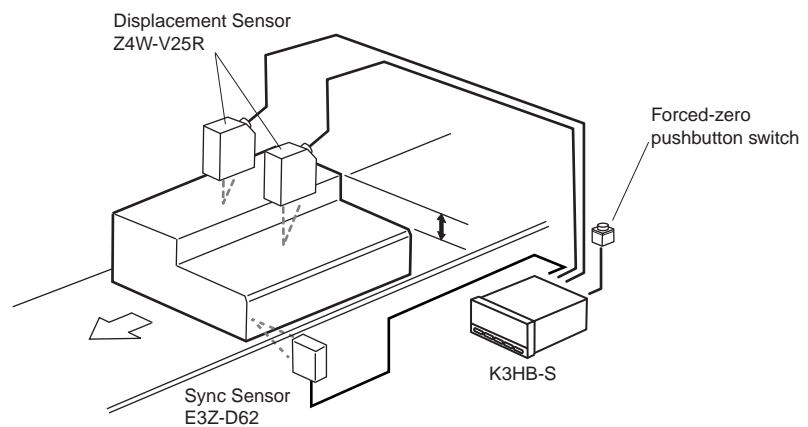

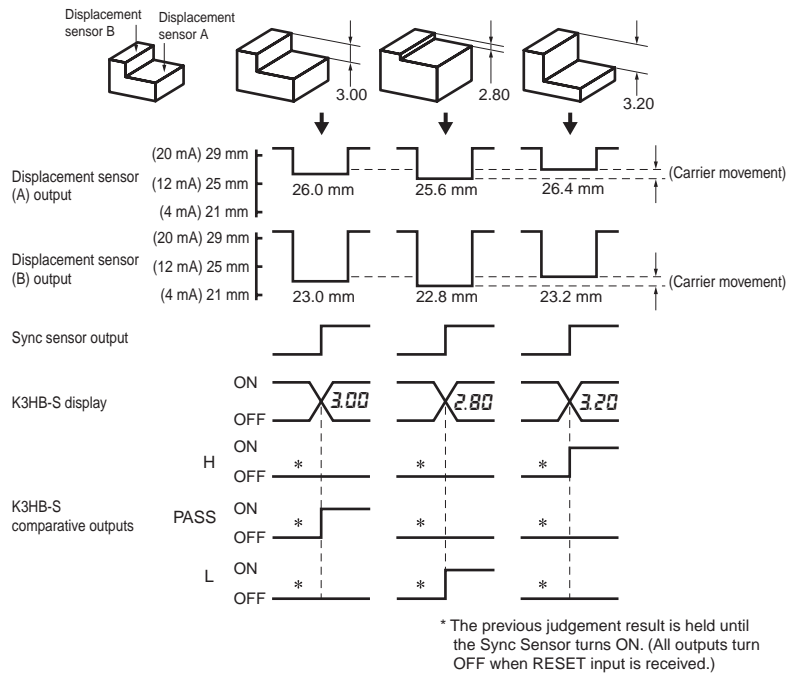

■ K3HB-S Setting Details

RUN Level

Parameter	Characters	Set value	Remarks
Comparative set value H	*	2.50	Monitoring a difference of ± 0.5 mm for a reference step of 2 mm
Comparative set value L	*	1.50	

* Check on the status displays.

Initial Setting Level (L 0)

Parameter	Characters	Set value	Remarks
Calculation	\overline{CAL}	4	A-B
Input type A	$\overline{IN-IA}$	4-20	<p>Z4W-V25R Output (mA)</p> <p>Displacement (mm)</p>
Scaling input value A1	$\overline{INP.A1}$	4.000	
Scaling display value A1	$\overline{DSP.A1}$	2.100	
Scaling input value A2	$\overline{INP.A2}$	20.000	
Scaling display value A2	$\overline{DSP.A2}$	2900	
Input type B	$\overline{IN-IB}$	4-20	
Scaling input value B1	$\overline{INP.B1}$	4.000	
Scaling display value B1	$\overline{DSP.B1}$	2.100	
Scaling input value B2	$\overline{INP.B2}$	20.000	
Scaling display value B2	$\overline{DSP.B2}$	2900	
Decimal point position	\overline{dP}	000.00	

Input Adjustment Level (L 1)

Parameter	Characters	Set value	Remarks
Timing hold	$\overline{ENH-H}$	5-H	Sampling hold

* Other parameters are set to their default values.

Section 4 Initial Setup

4.1	K3HB-X Initial Setup Example (K3HB-XVD).....	4-2
4.2	K3HB-V Initial Setup Example (K3HB-VLC).....	4-4
4.3	K3HB-H Initial Setup Example (K3HB-HTA).....	4-6
4.4	K3HB-S Initial Setup Example (K3HB-SSD).....	4-8

4.1 K3HB-X Initial Setup Example (K3HB-XVD)

The initial setup is explained in the following example.

Settings Example

In the following setting example, 1 to 5-V input is scaled to the range 0.000 to 1.000.

- If the measurement value goes above 0.700, comparative output H turns ON.
- If the measurement value goes below 0.500, comparative output L turns ON.

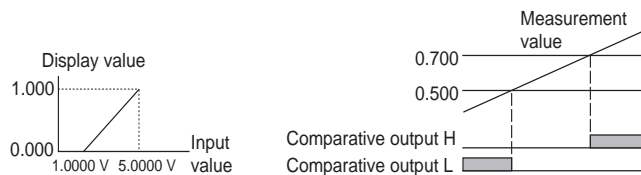

Initial Setup Flow

To change a set value, press the [SHIFT] Key. (The digit that can be changed will flash.) Use the [SHIFT] Key to move to the digit to be changed, and change the setting using the [UP] Key.

A Check the wiring and turn the power ON.

- If the display flashes “*S.E.R.*” this indicates that the input is outside the set range, and does not indicate product failure.

B Set input type A to 1.0000 to 5.0000 V.

1. Move to the initial setting level by pressing the [LEVEL] Key for at least 3 s (operation will stop).
2. Set input type A “*IN-1A*” to “*1 5*” and press the [MODE] Key twice.

C Set the scaling value.

1. Set scaling input value A1 “*INP. R1*” to “*1.0000*” and press the [MODE] Key.
2. Set scaling display value A1 “*DISP. R1*” to “*0*” and press the [MODE] Key.
3. Set scaling input value A2 “*INP. R2*” to “*5.0000*” and press the [MODE] Key.
4. Set scaling display value A2 “*DISP. R2*” to “*1000*” and press the [MODE] Key.

D Set the decimal point position.

1. Set the parameter “*dP*” to “*00.000*” and press the [MODE] Key.

● Note ●

When the power is turned ON, a number may be displayed that is unrelated to the input range setting.

To display correct values, the correct input type must be selected for the wiring.

● Note ●

Do not change the order of step B.

When input type A is set, the scaling value and decimal point position will be initialized automatically.

E Set comparative set value H to 0.700 and set comparative set value L to 0.500.

1. Return to the RUN level by pressing the [LEVEL] Key for at least 1 s. (Start operation.)
2. Press the [MODE] Key repeatedly until the SV display status shows .
3. Set the value to "0.700" and press the [MODE] Key. (The SV display status will show)
4. Set the value to "0.500" and press the [MODE] Key. The setting procedure is completed.

F Start actual operation.

1. Press the [MODE] Key repeatedly to display the measurement values and start actual operation.

Clearing Settings

If you become confused while setting the parameters and cannot continue, all settings can be cleared so that you can start over.

Refer to "5.40 Initializing All Settings" (P.5-100) for information on clearing all settings.

* Refer to "Section 5 Functions and Operations" for details on setting parameters.

4.2 K3HB-V Initial Setup Example (K3HB-VLC)

The initial setup is explained in the following example.

Settings Example

Indicated as 0 to 1N in the load cell specifications (rated load 1N, recommended applied voltage 10 V, rated output 2 mV/V *)

- If the measurement value goes above 0.700, comparative output H turns ON.
- If the measurement value goes below 0.500, comparative output L turns ON.

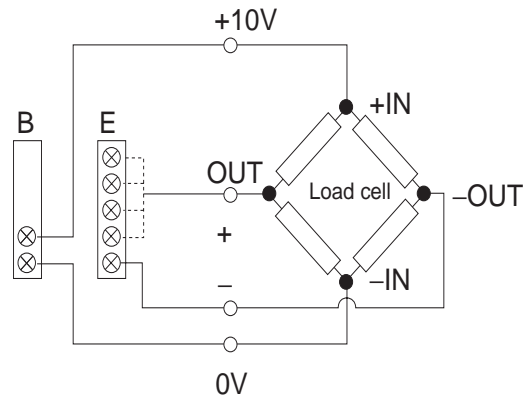
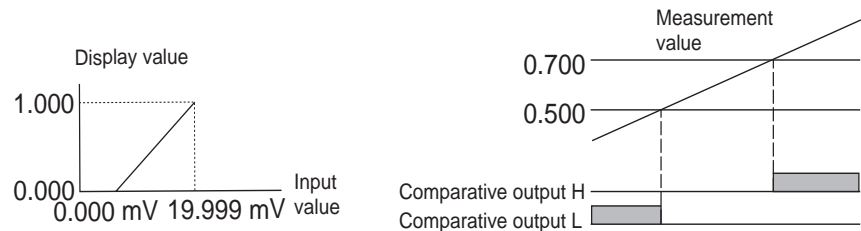

* 2 mV/V indicates a load cell output of 2 mV for 1 V applied voltage for the rated load (when using a load of 1 N). When the applied voltage is 10 V, the load cell output is 20 mV (2 mV×10)

Initial Setup Flow

● Note ●

When the power is turned ON, a number may be displayed that is unrelated to the input range setting.

To display correct values, the correct input type must be selected for the wiring.

● Note ●

Do not change the order of step B.

When input type A is set, the scaling value and decimal point position will be initialized automatically.

To change a set value, press the [SHIFT] Key. (The digit that can be changed will flash.) Use the [SHIFT] Key to move to the digit to be changed, and change the setting using the [UP] Key.

A Check the wiring and turn the power ON.

- If the display flashes "S.Err" this indicates that the input is outside the set range, and does not indicate product failure.

B Set input type A to 0.000 to 19.999 mV.

1. Move to the initial setting level by pressing the [LEVEL] Key for at least 3 s (operation will stop).
2. Set input type A "0.000 to 19.999" to "0.000 to 19.999" and press the [MODE] Key twice.

C Set the scaling value.

1. Set scaling input value A1 " $\overline{I}nP. R1$ " to "0.000" and press the \square [MODE] Key.
2. Set scaling display value A1 " $\overline{d}SP. R1$ " to "0" and press the \square [MODE] Key.
3. Set scaling input value A2 " $\overline{I}nP. R2$ " to "19.999" and press the \square [MODE] Key.
4. Set scaling display value A2 " $\overline{d}SP. R2$ " to "1000" and press the \square [MODE] Key.

D Set the decimal point position.

1. Set the parameter " $\overline{d}P$ " to "00.000" and press the \square [MODE] Key.

E Set comparative set value H to 0.700 and set comparative set value L to 0.500.

1. Return to the RUN level by pressing the \square [LEVEL] Key for at least 1 s. (Start operation.)
2. Press the \square [MODE] Key repeatedly until the SV display status shows \textcircled{H} .
3. Set the value to "0.700" and press the \square [MODE] Key. (The SV display status will show \textcircled{L} .)
4. Set the value to "0.500" and press the \square [MODE] Key. The setting procedure is completed.

F Start actual operation.

1. Press the \square [MODE] Key repeatedly to display the measurement values and start actual operation.

Clearing Settings

If you become confused while setting the parameters and cannot continue, all settings can be cleared so that you can start over.

Refer to "5.40 Initializing All Settings" (P.5-100) for information on clearing all settings.

* Refer to "Section 5 Functions and Operations" for details on setting parameters.

4.3 K3HB-H Initial Setup Example (K3HB-HTA)

The initial setup is explained in the following example.

Settings Example

Using the K thermocouple (-200.0 to 1300.0°C) to measure the temperature, and display in °C.

- If the measurement value goes 500°C or higher, comparative output H turns ON.
- If the measurement value goes 100°C or lower, comparative output L turns ON.

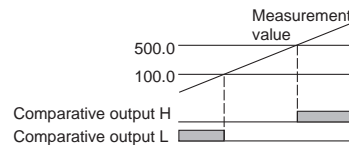

Initial Setup Flow

To change a set value, press the [SHIFT] Key. (The digit that can be changed will flash.) Use the [SHIFT] Key to move to the digit to be changed, and change the setting using the [UP] Key.

● Note ●

When the power is turned ON, a number may be displayed that is unrelated to the input range setting.

To display correct values, the correct input type must be selected for the wiring.

A Check the wiring and turn the power ON.

- If the display flashes “5.Err” this indicates that the input is outside the set range, and does not indicate product failure.

B Set input type A to K thermocouple (-200.0 to 1300.0°C).

1. Move to the initial setting level by pressing the [LEVEL] Key for at least 3 s (operation will stop).
2. Set input type A “-A” to “-K” and press the [MODE] Key twice.

C Set the temperature unit.

- Set the temperature unit “-U” to “C” and press the [MODE] Key.

D Set comparative set value H to 500.0 and set comparative set value L to 100.0.

1. Return to the RUN level by pressing the [LEVEL] Key for at least 1 s. (Start operation.)
2. Press the [MODE] Key repeatedly until the SV display status shows (H).
3. Set the value to “500.0” and press the [MODE] Key. (The SV display status will show (L).)
4. Set the value to “100.0” and press the [MODE] Key. The setting procedure is completed.

E Start actual operation.

1. Press the [MODE] Key repeatedly to display the measurement values and start actual operation.

Clearing Settings

If you become confused while setting the parameters and cannot continue, all settings can be cleared so that you can start over.

Refer to "5.40 Initializing All Settings" (P.5-100) for information on clearing all settings.

* Refer to "Section 5 Functions and Operations" for details on setting parameters.

4.4 K3HB-S Initial Setup Example (K3HB-SSD)

The initial setup is explained in the following example.

Settings Example

In the following setting example, 1 to 5-V input is scaled to the range 0.000 to 1.000.

- If the measurement value goes above 0.700, comparative output H turns ON.
- If the measurement value goes below 0.500, comparative output L turns ON.

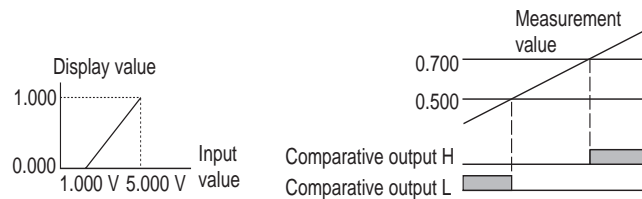

Initial Setup Flow

To change the setting, press the [SHIFT] Key once. (The setting that can be changed will start flashing.) Change the set value by pressing the [SHIFT] Key and [UP] Key.

A Check the wiring and turn the power ON. (Connect the sensor to input A.)

- The input type is factory-set to 4 to 20-mA input. When the power is turned ON, the display may flash "R Err" (outside the input range). This simply indicates, however, that the input is outside the range 4 to 20 mA and does not indicate a product failure.

B Set the calculation to 0.

1. Move to the initial setting level by pressing the [LEVEL] Key for at least 3 s with the PV displayed (RUN level).
2. Set "CAL" to "0" and press the [MODE] Key.

C Set input type A to 1 to 5 V.

- Set "I-P" to "1-5" and press the [MODE] Key.

D Set the scaling value.

1. Set scaling input value A1 "I.P. R1" to "1.000" and press the [MODE] Key.
2. Set scaling display value A1 "dSP. R1" to "0" and press the [MODE] Key.
3. Set scaling input value A2 "I.P. R2" to "5.000" and press the [MODE] Key.
4. Set scaling display value A2 "dSP. R2" to "1000" and press the [MODE] Key.

E Set the decimal point position.

1. Set the parameter "dP" to "00.000" and press the [MODE] Key.

● Note ●

Do not change the order of step C.

When input type A is set, the scaling value and decimal point position will be initialized automatically.

F Set comparative set value H to 0.700 and set comparative set value L to 0.500.

1. Return to the RUN level by pressing the [LEVEL] Key for at least 1 s. (Start operation.)
2. Press the [MODE] Key repeatedly until the status display shows (H), and then set the value to "0.700."
3. Press the [MODE] Key until the status display shows (H), and then set the value to "0.500."

G Start actual operation.

1. Press the [MODE] Key repeatedly to display the measurement values and start actual operation.

Clearing Settings

If you become confused while setting the parameters and cannot continue, all settings can be cleared so that you can start over.

Refer to "5.40 Initializing All Settings" (P.5-100) for information on clearing all settings.

* Refer to "Section 5 Functions and Operations" for details on setting parameters.

Section 5 Functions and Operations

Knowledge Required for Setting Parameters.....	5-2
----- Operation Adjustments -----	
5.1 Setting Calculations	5-9
5.2 Setting Input Types	5-11
5.3 Setting Scaling Values	5-14
5.4 Setting the Temperature Unit	5-18
5.5 Setting Measurement Operations	5-19
5.6 Shifting the Temperature Input.....	5-24
5.7 Resetting Measurements	5-26
5.8 Not Performing Measurements for Set Intervals	5-27
----- Input Adjustments -----	
5.9 Selecting Operations for Input Errors.....	5-29
5.10 Disabling Cold Junction Compensation	5-31
5.11 Adjusting Timing Inputs	5-33
5.12 Eliminating Drift Near "0"	5-36
5.13 Averaging Inputs	5-38
5.14 Detecting Sudden Input Changes	5-41
----- Output Adjustments -----	
5.15 Changing Comparative Output Patterns	5-44
5.16 Preventing Output Chattering	5-46
5.17 Outputting for a Set Interval	5-49
5.18 Delaying Output OFF Timing	5-52
5.19 Holding Measurement Status	5-54
5.20 Holding Comparative Outputs.....	5-55
5.21 Allocating Another Output to PASS Output.....	5-57
5.22 Reversing Output Logic	5-59
5.23 No Output before PASS Range.....	5-61
5.24 Performing Linear Output.....	5-63
----- Display Adjustments -----	
5.25 Setting the Present Measurement Value to "0"	5-65
5.26 Setting the Present Measurement Value to "0" Again when Using a Forced Zero	5-67
5.27 Compensating Forced-zero References	5-70
5.28 Changing Display Refresh Periods	5-73
5.29 Holding Maximum and Minimum Values	5-75
5.30 Changing Normal Display Values to Maximum and Minimum Values	5-78
5.31 Setting the Step for Changing the Rightmost Digit	5-80
5.32 Displaying/Not Displaying Comparative Set Values	5-82
5.33 Changing Display Colors	5-83
5.34 Using the Position Meter	5-85
5.35 Automatic Return to Normal Display.....	5-88
5.36 No Decimal Point Display.....	5-90
----- Other Operations -----	
5.37 Performing Output Tests	5-92
5.38 Using Comparative Set Value Banks	5-93
5.39 Copying Bank Comparative Set Values	5-98
5.40 Initializing All Settings	5-100
5.41 Limiting Key Operations	5-102

Knowledge Required for Setting Parameters

■ About Levels

Levels are groups of parameters.

Levels for the K3HB are classified as follows:

Important

Depending on the level, measurements may continue to be executed or stop. Check the measurement operation.

Level	Function	Measurement operations
Protect	Makes settings to prevent inadvertent key operations. Movement between levels and changes to settings may be prohibited, depending on the protect settings.	Executed
RUN	The normal operation mode where inputs are read and comparative judgements are made. In RUN level, the present value can be displayed, comparative set values checked, and forced-zero executed or cleared. The K3HB is in RUN mode immediately after the power is turned ON.	
Adjustment	Switches banks and makes settings, such as communications write settings.	
Initial setting	Makes initial settings, such as the input type, scaling, and comparative output patterns.	Stopped
Input adjustment	Adjusts inputs.	
Display adjustment	Enables/disables comparative set value displays, and sets the display refresh periods, display color, and position meter.	
Comparative set value	Makes comparative set value bank settings.	
Linear output	Sets the linear output.	
Communications setting	Sets the baud rate, data length, and other communications settings.	
Output test	Sets test measurement values to perform output tests.	
Advanced function settings	Used for advanced customization.	

To change a parameter, move to the level where that parameter is found. The current level is shown on the bank/level display when moving between levels.

Level/bank display	Level
L ^P	Protect level
Not lit or B ⁰ to 7	RUN level (Lights only when banks are used.)
L ^R	Adjustment level
L ⁰	Initial setting level
L ¹	Input adjustment level
L ²	Display adjustment level
L ⁴	Comparative set value level
L ⁵	Linear output level
L ⁶	Communications setting level
L ^t	Output test level
L ^F	Advanced function setting level

■ Moving between Levels

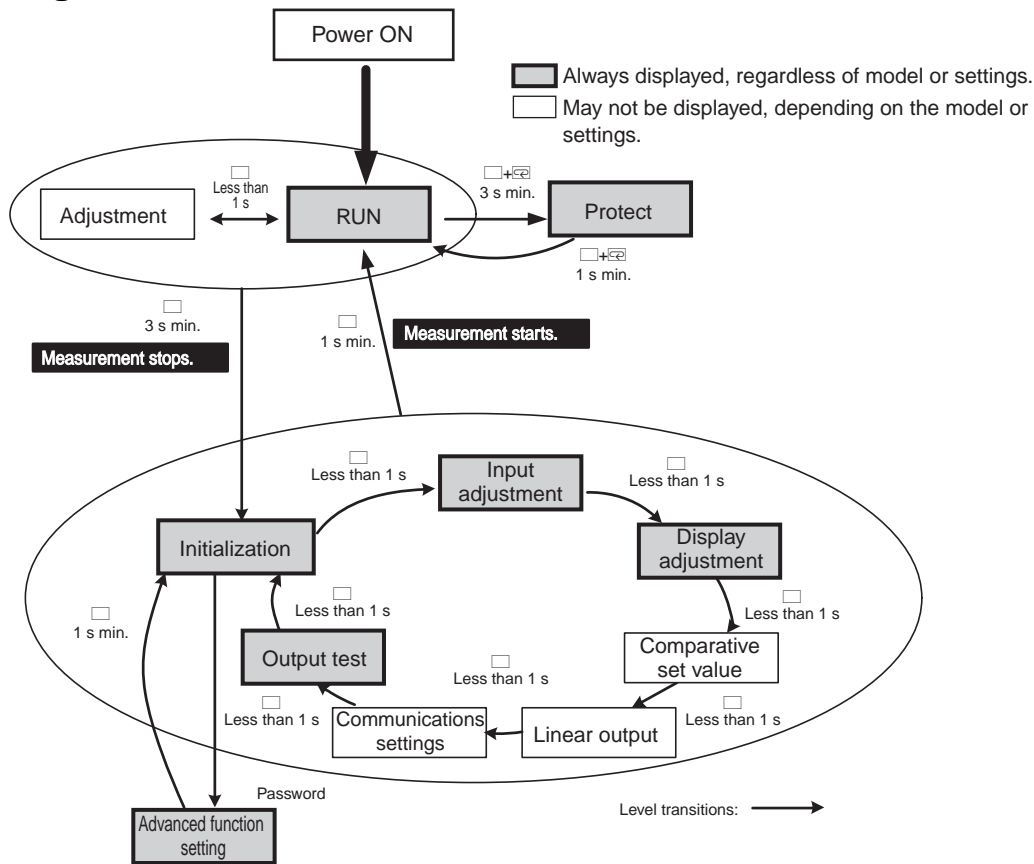

To Protect Level

Press the [LEVEL] and [MODE] Keys in RUN level for at least 1 s. The PV display will start to flash. Press the same keys for at least 2 s to move to protect level. Press the [LEVEL] and [MODE] Keys for at least 1 s to return to RUN level.

To Adjustment Level

Press the [LEVEL] Key in RUN level once (less than 1 s). The level will change to adjustment level when the key is released. Use the same operation to return from adjustment level to RUN level.

To Initial Setting Level

Press the [LEVEL] Key in RUN or adjustment level for at least 1 s. The PV display will start to flash. Press the [LEVEL] Key for at least 2 s to move to the initial setting level. Press the [LEVEL] Key for at least 1 s to return to the RUN level from the initial setting level.

Input Adjustment Level, Display Adjustment Level, Comparative Set Value Level, Linear Output Level, Communications Setting Level, Output Test Level

First, move to initial setting level. Press the [LEVEL] Key in initial setting level (less than 1 s) each time to move to the next level. Move to the next level from the output test level to return to the initial setting level.

Advanced Function Setting Level

A special operation is required to move to the advanced function setting level. Use the following procedure.

Procedure

The Setting Level Protect setting must be set to 0 (SEt.Pt=0) to enable moving to the advanced function setting level.

A Move to the initial setting level, press the [MODE] Key several times to display the “Añow” (move to advanced function setting level) parameter.

B Press the [SHIFT] Key to enable entering the password.

C Use the [SHIFT] and [UP] Keys to set the password. The password is “-0 169” (-0169).

D Press the [MODE] Key to write the password.

- The advanced function setting level will be entered if the password is correct.
- If the password is incorrect, the first parameter on the initial setting level will be displayed.

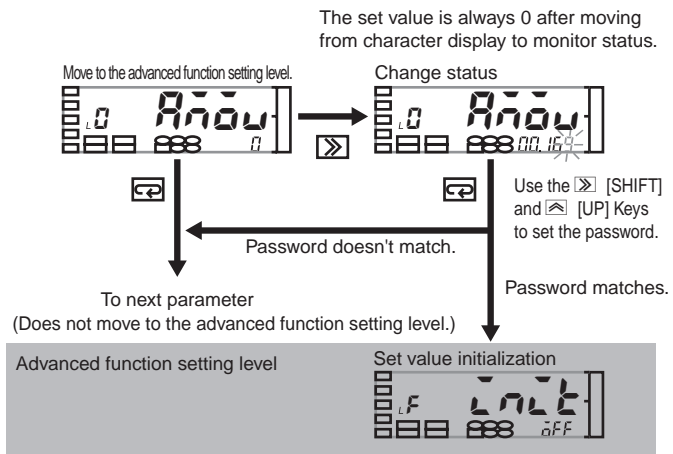

■ Monitoring and Changing Set Values

The value set for a parameter is called the “set value.”
Set values can be numerals or characters.

When the SV display is lit, it is called the “monitor status.” When the SV display is flashing, it is called the “change status.”

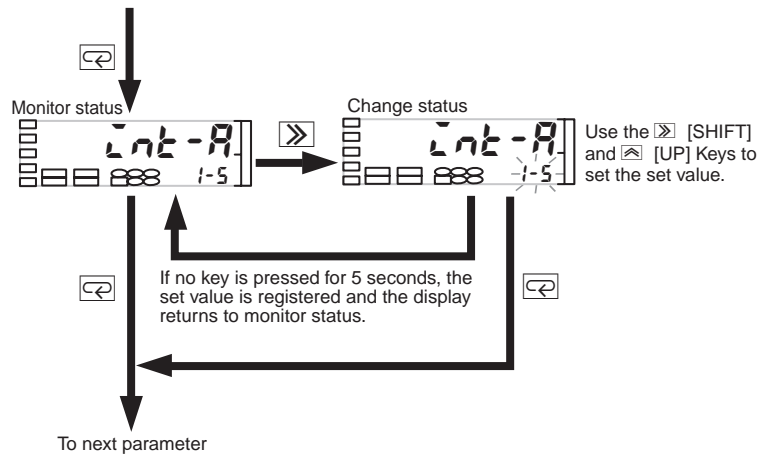

Use the following procedure to change set values.

Procedure

A The parameter to be changed is displayed.

- At this stage, the set value is displayed but cannot be changed.

B Press the [SHIFT] Key once to enable changing the setting.

- The place that can be changed starts to flash.

C Use the [SHIFT] and [UP] Keys to change the setting.

D Press the [MODE] Key to switch to the next parameter.

- The changed set value is stored in the internal memory.
- If no key is pressed at step C for 5 s,* the set value is registered and the display automatically returns to monitor status.

* If the display is on RUN level or adjustment level, the time before the return to monitor status depends on the setting for the “automatic display return time.” If the “automatic display return time” setting is less than 5 s, for example, 3 s, then if there are no key operations in change status for 3 s, the changed set value is registered and the display automatically returns to the display when the power was turned ON.

■ Confirming and Changing Comparative Set Values

Comparative set values are confirmed and changed in RUN level.
(The Unit keeps operating even while comparative set values are being confirmed and changed.)

The comparative set values from HH to LL are displayed each time the [MODE] Key is pressed in the operation status immediately after the power is turned ON. The SV display status (HH)(H)(L)(LL) is lit for the displayed comparative set value.

Some comparative set values may not be displayed, depending on the relay/transistor output specifications and settings.

Refer to the parameter setting procedures for information on how to change comparative set values.

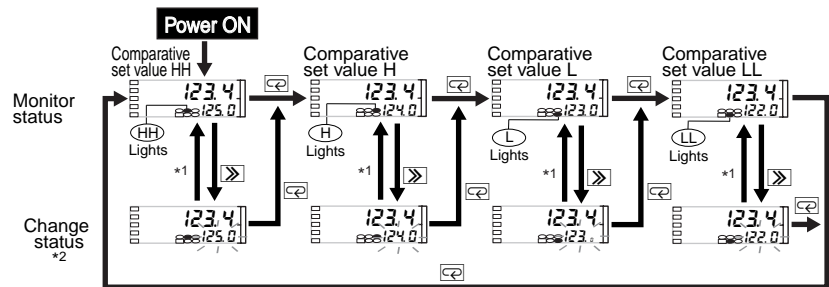

*1 If no key is pressed for 5 seconds, the set value is registered and the display returns to monitor status.

*2 Use the [SHIFT] and [UP] Keys to set the set value.

Displayed Comparative Set Values

Relay/transistor output specifications	Displayed comparative set values			
	HH	H	L	LL
H/L Models with Relay Outputs <C1>		○	○	
HH/H/L/LL Models with Relays Outputs <C2>	○	○	○	○
HH/H/PASS/L/LL Models with Transistor Outputs <T1><T2>	○	○	○	○
None*				

* For Sensor Power Supply/Output Models with a PASS Output, the displayed comparative set value depends on the allocation setting of the PASS output.

PASS (PASS output change)	Displayed comparative set value			
	HH	H	L	LL
LL				○
L			○	
PASS				
H		○		
HH	○			
Err.				



Allocating other outputs to PASS output → P.5-57

* When *Su.dSP* (comparative set value display) is set to OFF, comparative set values are not displayed during operation but are displayed with key operations.

Parameter Setting Procedure

A Press the  [MODE] Key several times to display the comparative set value to be changed.





One of the values between HH and LL will flash, according to the displayed comparative set value.

B Press the  [SHIFT] Key to make the SV display flash.

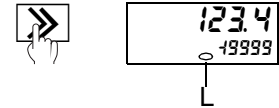
- The setting can be changed when the SV display starts to flash.



C Use the  [SHIFT] Key and  [UP] Key to change the comparative set value.

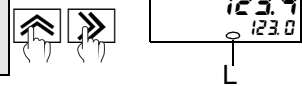

D Press the  [MODE] Key to switch to the next parameter.

- The comparative set value set in C will be registered.

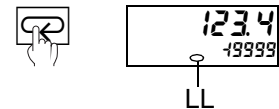

5.1 Setting Calculations

Initial setting level

S

The K3HB-S can add, subtract, and display two analog inputs, input A and input B.

Explanation of Functions

Calculation and constant K

■ A

- Select to use only input A.

■ B

- Select to use only input B.

■ K-A

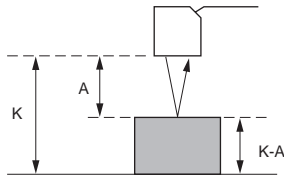

- Select to subtract input A from a constant.
- K can be set to any value.
- This function is useful for applications such as measuring the height of a workpiece.

■ A+B

- Select to add input A and B values.

■ A-B

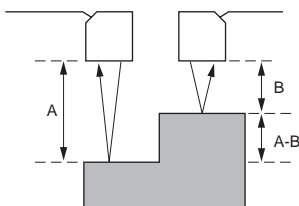

- Select to subtract input B from input A.
- This function is useful for applications such as measuring steps in workpieces.

■ K-(A+B)

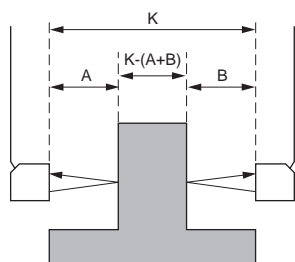

- Select to subtract input A and B values from a constant.
- K can be set to any value.
- This function is useful for applications such as measuring the thickness of a workpiece.

■ $B/A \times 10000$

- Select to display the ratio between input A and input B.

■ $(B/A-1) \times 10000$

- Select to display the error ratio for input B and input A.

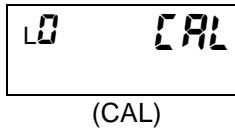

Set using the following parameter.

Parameter	Set value	Meaning of set value
Calculation CAL	0	A
	1	B
	2	K-A
	3	A+B
	4	A-B
	5	K-(A+B)
	6	$B/A \times 10000$
	7	$(B/A-1) \times 10000$

Parameter Setting Procedure

A Press the [LEVEL] Key for at least 3 s in RUN level to move to the initial setting level.



3 s min.

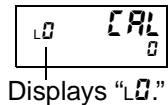

Displays "LO."

- "LO" is displayed on the level/bank display to indicate the initial setting level.

B Press the [SHIFT] Key to make the SV display flash.

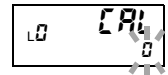

- The setting can be changed when the SV display starts to flash.

C Use the [UP] Key to change the set value.

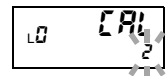

D Press the [MODE] Key to switch to the next PV display.



- The set value is registered.



Setting constant K. → P.5-16

5.2 Setting Input Types

Initial setting level

X V S H

K3HB-X

(IN-TA)

(FRE)

Set the input type to match the connected input device.

Parameter	Set value	Meaning of set value
DC voltage (XVD) Input type A IN-TA	A ud	±199.99 V
	b ud	±19.999 V
	c ud	±1.9999 V
	d ud	1.0000 to 5.0000 V
DC current (XAD) Input type A IN-TA	A Ad	±199.99 mA
	b Ad	±19.999 mA
	c Ad	±1.9999 mA
	d Ad	4.000 to 20.000 mA
AC voltage (XVA) Input type A IN-TA	A uA	0.0 to 400.0 V
	b uA	0.00 to 199.99 V
	c uA	0.000 to 19.999 V
	d uA	0.0000 to 1.9999 V
AC current (XAA) Input type A IN-TA	A AA	0.000 to 10.000 A
	b AA	0.0000 to 1.9999 A
	c AA	0.00 to 199.99 mA
	d AA	0.000 to 19.999 mA
Power supply frequency* FRE	50	50 Hz
	60	60 Hz

* Eliminates inductive noise from the power supply line. Set to the power supply frequency.

K3HB-V

(IN-TA)

(FRE)

Parameter	Set value	Meaning of set value
Input type A IN-TA	A LL	0.000 to 199.99 mV
	b LL	0.000 to 19.999 mV
	c LL	±100.00 mV
	d LL	±199.99 mV
Power supply frequency* FRE	50	50 Hz
	60	60 Hz

* Eliminates inductive noise from the power supply line. Set to the power supply frequency.

K3HB-S

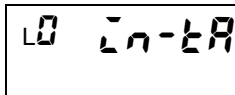

(IN-TA)

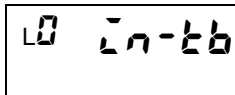

(IN-TB)

Parameter	Set value	Meaning of set value
Input type A IN-TA or Input type A IN-TB	0-20	0.000 to 20.000 mA
	4-20	4.000 to 20.000 mA
	0-5	0.000 to 5.000 V
	1-5	1.000 to 5.000 V
	5	±5.000 V
	10	±10.000 V

* Make sure the terminal wiring is correct for the input range. Otherwise, correct values will not be displayed.

K3HB-H

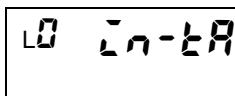

(IN-TA)

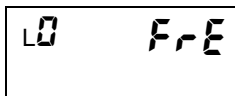

(FRE)

Parameter	Set value	Meaning of set value	
		°C	°F
Input type A IN-TA	0-Pt	-200.0 to 850.0	-300.0 to 1500.0
	1-Pt	-150.00 to 150.00	-199.99 to 300.00
	2-V	-200.0 to 1300.0	-300.0 to 2300.0
	3-V	-20.0 to 500.0	0.0 to 900.0
	4-V	-100.0 to 850.0	-100.0 to 1500.0
	5-V	-20.0 to 400.0	0.0 to 750.0
	6-t	-200.0 to 400.0	-300.0 to 700.0
	7-E	0.0 to 600.0	0.0 to 1100.0
	8-L	-100 to 850.0	-100.0 to 1500.0
	9-U	-200.0 to 400.0	-300.0 to 700.0
	10-n	-200.0 to 1300.0	-300.0 to 2300.0
	11-r	0.0 to 1700.0	0.0 to 3000.0
	12-S	0.0 to 1700.0	0.0 to 3000.0
	13-b	100.0 to 1800.0	300.0 to 3200.0
14-V	0.0 to 2300.0	0.0 to 4100.0	
Power supply frequency* FRE	50	50 Hz	
	60	60 Hz	

* Eliminates inductive noise from the power supply line. Set to the power supply frequency.

Parameter Setting Procedure: Input Type

The following procedure uses the K3HB-S as an example.

A Press the [LEVEL] Key for at least 3 s in RUN level to move to the initial setting level.





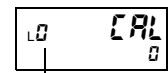

3 s min.



Displays "LD."



- "LD" is displayed on the level/bank display to indicate the initial setting level.

- B** If the PV display is not “ $\bar{L}n-tA$ ” or “ $\bar{L}n-tB$,” press the  [MODE] Key to display the desired parameter.
- C** Press the  [SHIFT] Key to make the SV display flash.
- The setting can be changed when the SV display starts to flash.
- D** Use the  [UP] Key to change the set value.
- E** Press the  [MODE] Key to switch to the next parameter.
- The set value is registered.
- F** Press the  [LEVEL] Key for at least 1 s to return to the RUN level.
- 1 s min.

Parameter Setting Procedure: Power Supply Frequency*

Set the input type for the K3HB-X/V/H and then set the power supply frequency.

Perform step E above and then perform the following steps.

- G** Press the  [MODE] Key several times to change the PV display to “FrE.”
- H** Press the  [SHIFT] Key to make the SV display flash.
- The setting can be changed when the SV starts to flash.
 - Set the frequency to 50 Hz or 60 Hz to match the local frequency.

* If input type A is changed, scaling input values A1 and A2 and scaling display values A1 and A2 are initialized. The same applies to input type B.

** Input type A is the only choice for all models except the K3HB-S.

5.3 Setting Scaling Values

Initial setting level



One Point*

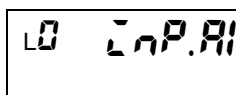

(INP.A1)

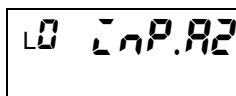

(INP.A2)

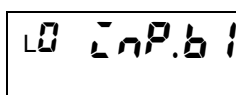

(INP.B1)

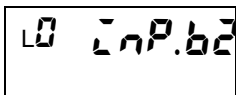

(INP.B2)

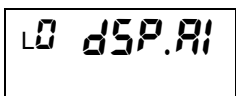

(DSP.A1)

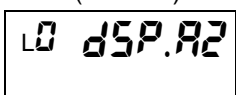

(DSP.A2)

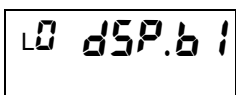

(DSP.B1)

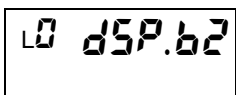

(DSP.B2)



(DP)



(K)

Set scaling to convert and display input values as any values. Inputs A and B are set separately.

Setting Parameter for Input A

Parameter	Set value	Meaning of set value
Scaling input value A1 INP.A1	-99999 to 99999*	Input value corresponding to DSP.A1
Scaling display value A1 DSP.A1	-99999 to 99999	Display value corresponding to INP.A1
Scaling input value A2 INP.A2	-99999 to 99999*	Input value corresponding to DSP.A2
Scaling display value A2 DSP.A2	-99999 to 99999	Display value corresponding to INP.A2

Setting Parameter for Input B (K3HB-S Only)

Parameter	Set value	Meaning of set value
Scaling input value B1 INP.b1	-99999 to 99999*	Input value corresponding to DSP.b1
Scaling display value B1 DSP.b1	-99999 to 99999	Display value corresponding to INP.b1
Scaling input value B2 INP.b2	-99999 to 99999*	Input value corresponding to DSP.b2
Scaling display value B2 DSP.b2	-99999 to 99999	Display value corresponding to INP.b2

* The decimal point position for scaling input values depends on the input type.

The decimal point position for scaling display values depends on the decimal point position [dP] setting.

Parameter	Set value	Meaning of set value
Decimal point position dP	00000	No decimal point
	0000.0	One digit below the decimal point is displayed.
	000.00	Two digits below the decimal point are displayed.
	00.000	Three digits below the decimal point are displayed.
	0.0000	Four digits below the decimal point are displayed.

* Use the teaching function to use actual inputs to set scaling input values "INP.A1," "INP.A2," "INP.b1," and "INP.b2." Refer to "Teaching" (P.5-17) for details.

Set constant K [μ] when setting the calculation [μ] to K-A [μ] or K-(A+B) [μ] (K3HB-S only).

Parameter	Set value	Meaning of set value
Constant K μ	-9999 to 99999	-19999 to 99999

The decimal point will be according to the decimal point position setting.

Explanation of Functions

Scaling

Scaling is a function that applies a preset conversion formula to sampled input values to convert each input value to a measurement value. The input values can thus be converted to Units used by the system.

The scaling conversion formula for voltage/current input is shown below.

$$dsp = \frac{DSP2 - DSP1}{INP2 - INP1} inp + \frac{INP1 \cdot DSP2 - INP2 \cdot DSP1}{INP2 - INP1}$$

Here,

INP1: The input value for measurement value DSP1

DSP1: The measurement value for input value INP1

INP2: The input value for measurement value DSP2

DSP2: The measurement value for input value INP2

inp: Input value for each sampling



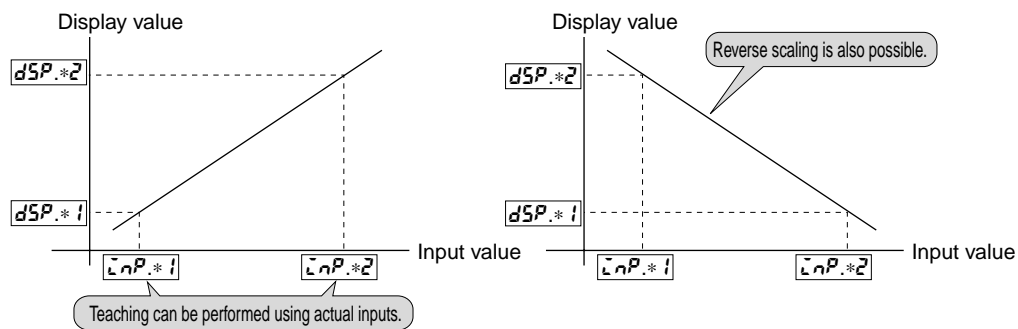



dsp: Corresponding measurement value



Scaling

Parameter Setting Procedure: Scaling Settings for Input A

The following procedure uses the K3HB-S as an example.





- A** Press the  [LEVEL] Key for at least 3 s in RUN level to move to the initial setting level.
- "L0" is displayed on the level/bank display to indicate the initial setting level.
- B** Press the  [MODE] Key several times to switch the PV display to "LnP.R1."
- Teaching is possible for scaling input value A1. "T" is lit to indicate that teaching is possible.
 - Refer to P.5-17 for the teaching method.
- C** Press the  [SHIFT] Key to make the SV display flash.
- The setting can be changed when the SV display starts to flash.
- D** Use the  [UP] and  [SHIFT] Keys to change the set value.
- E** Press the  [MODE] Key to switch the PV display to "dSP.R1."
- F** Repeat steps C to E and set "dSP.R1," "LnP.R2," and "dSP.R2."

Use the same procedure to set the "LnP.b1," "dSP.b1," "LnP.b2," and "dSP.b2" parameters for scaling input B (K3HB-S only).













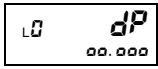

**Constant K
(K3HB-S Only)**

Use steps G to I to set constant K, if required.

Proceed to step J if constant K is not included in the calculation and does not, therefore, need to be set.

- G** Press the  [MODE] Key several times to switch the PV display to "K."
- The set value is registered.
- H** Press the  [SHIFT] Key to make the SV display flash.
- I** Use the  [UP] and  [SHIFT] Keys to change the set value.



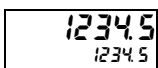



Decimal Point Position

- A** Press the  [MODE] Key to switch the PV display to the next parameter "dP."
- 
- 
- B** Press the  [SHIFT] Key to make the SV display flash.
- The setting can be changed when the SV starts to flash.
- 
- 
- C** Use the  [UP] Key to change the set value.
- 
- 
- D** Press the  [MODE] Key to switch to the next parameter.
- The set value is registered.
- 
- 
- E** Press the  [LEVEL] Key for at least 1 s to return to the RUN level.
- 
- 
- 1 s min.

Teaching

Use the teaching function to use real inputs to set scaling input values "LnP.R1," "LnP.R2," "LnP.b1," and "LnP.b2."

Parameter Setting Procedure

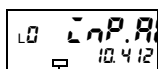
- After performing step B, press the  [UP] Key.
- "T" lights and "T" flashes.
 - The setting changes to match the actual input.
- 
- 
- "T" is lit.
- Press the  [UP] Key again.
- "T" lights and the input value is registered as the set value and the monitor mode is entered.
 - Press the  [MODE] Key when in teaching mode to cancel teaching and switch to the next parameter.
- 
- 
- "T" changes from flashing to being lit.

* The input value will not be registered if a sensor error occurs during teaching or the  [UP] Key is pressed when no measurement has been made.

5.4 Setting the Temperature Unit

Initial setting level

H

Either °C or °F can be set as the temperature unit.

Parameter Setting Procedure

A Press the  [LEVEL] Key for at least 3 s in RUN level to move to the initial setting level.



3 s min.

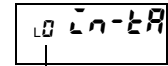

Displays "L0."

- "L0" is displayed on the level/bank display to indicate the initial setting level.

B Press the  [MODE] Key several times to change the PV display to "d-U."

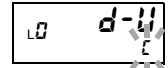

C Press the  [SHIFT] Key to make the SV display flash.



- The setting can be changed when the SV starts to flash.

D Press the  [UP] Key to select °C or °F.



- "C": °C, "F": °F

E Press the  [LEVEL] Key for at least 1 s to return to RUN level.



1 s min.

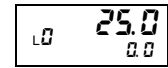

5.5 Setting Measurement Operations

Input adjustment level

X V S H

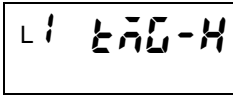

(TMG-H)

Applicable models:

K3HB-□□□

+

K35-1

K35-2

K35-3

K35-4

The K3HB has 5 measurement modes, which are set using the following parameter.

Parameter	Set value	Meaning of set value
Timing hold 250-H	Normal	Normal
	S-H	Sampling hold
	P-H	Peak hold
	b-H	Bottom hold
	P-P	Peak-to-peak hold

Normal

- Measurement are performed continuously and outputs are based on comparative results.
- TIMING inputs are ignored.
- When the measurement value exceeds the measurement range, a sensor error will occur and all outputs will turn OFF.
- The measurement value immediately prior to a HOLD input is held during the HOLD input. Measurements are not performed during RESET input.
- If RESET and HOLD inputs are competing, the RESET input will take priority.

Important*

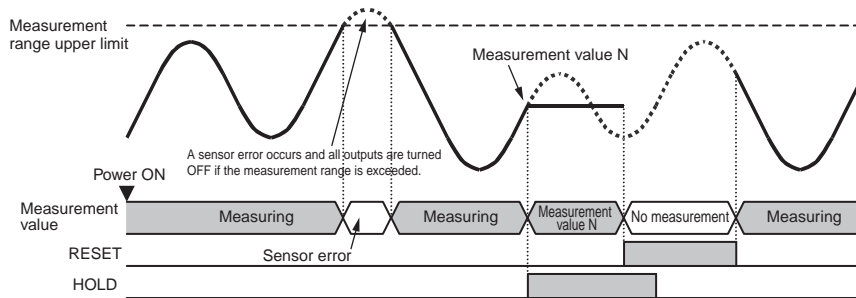

The PV display will show “-----” during RESET input (no measurement status).



Selecting operations for input errors → P.5-29

Operation will continue if input error enable is set to OFF (disabled) or OVER (overflow).

Important*

Sampling Hold

- The measurement is held from the rising edge of the TIMING signal.
- When the measurement value exceeds the measurement range, a sensor error will occur and all outputs will turn OFF.
- Measurements are not performed during RESET input and TIMING inputs are disabled.

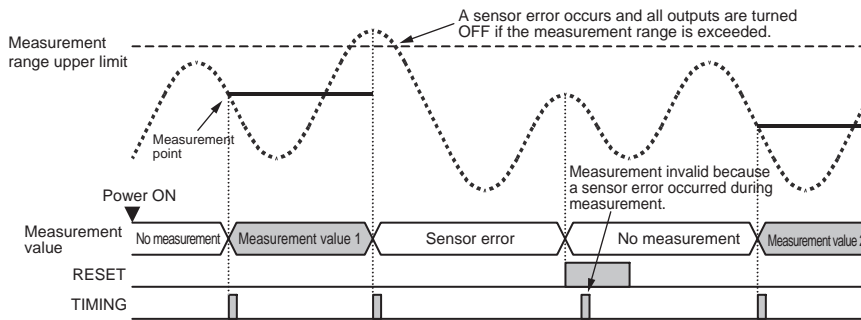

The PV display will show “-----” in no measurement status.



Selecting operations for input errors → P.5-29

Operation will continue if input error enable is set to OFF (disabled) or OVER (overflow).

Peak Hold

- The maximum value is held while measurement is being performed (while the TIMING input is ON) and when the measurement has been completed (when the TIMING input turns OFF) the measurement value is refreshed using the held maximum value.
- When the measurement value exceeds the measurement range during measurement, a sensor error will occur, a sensor error will immediately show on the display, and all outputs will turn OFF. Also, the measurement at that time will be invalid.
- Measurements are not performed and TIMING inputs are disabled during RESET input.

Important*

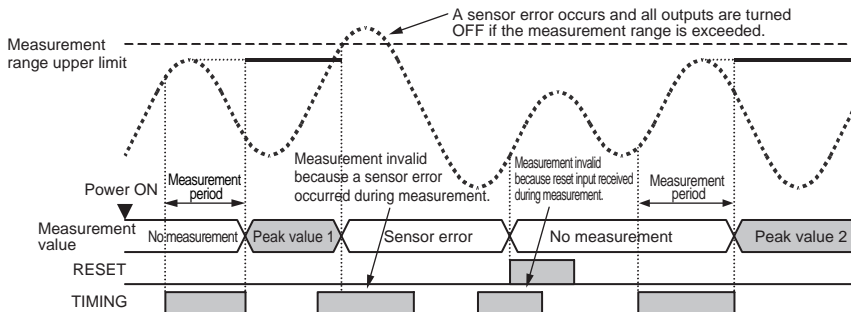

The PV display will show “-----” in no measurement status.



Selecting operations for input errors → P.5-29

Operation will continue if input error enable is set to OFF (disabled) or OVER (overflow).

Important***Bottom Hold**

- The minimum value is held while measurement is being performed (while the TIMING input is ON) and when the measurement has been completed (when the TIMING input turns OFF) the measurement value is refreshed using the held minimum value.
- When the measurement value exceeds the measurement range during measurement, a sensor error will occur, a sensor error will immediately show on the display, and all outputs will turn OFF. Also, the measurement at that time will be invalid.
- Measurements are not performed during RESET input and TIMING inputs are disabled.

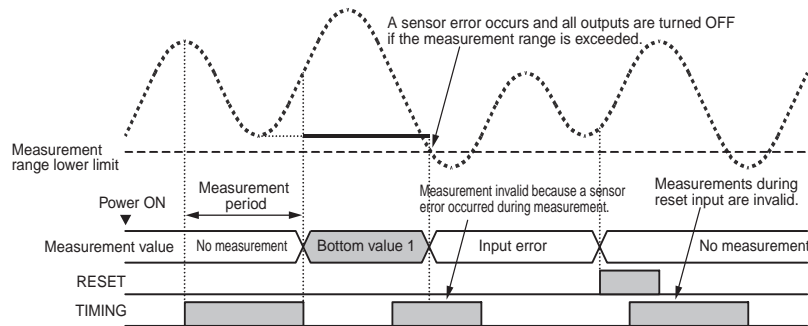

The PV display will show “- - - -” in no measurement status.



Selecting operations for input errors → P.5-29

Operation will continue if input error enable is set to OFF (disabled) or OVER (overflow).

Important***Peak-to-peak Hold**

- The maximum and minimum values are held while measurement is being performed (while the TIMING input is ON). When the measurement has been completed (when the TIMING input turns OFF), the measurement value is refreshed using the maximum value minus the minimum value (i.e., the peak-to-peak value).
- When the maximum or minimum value exceeds the measurement range during measurement, a sensor error will occur, a sensor error will immediately show on the display, and all outputs will turn OFF. Also, the measurement at that time will be invalid.
- Measurements are not performed and TIMING inputs are disabled during RESET input.

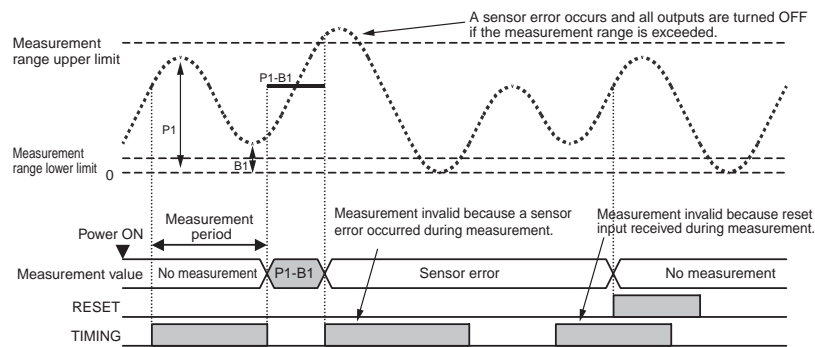

The PV display will show “- - - -” in no measurement status.

















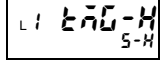

Selecting operations for input errors → P.5-29

Operation will continue if input error enable is set to OFF (disabled) or OVER (overflow).

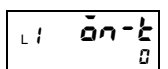
* If the measurement exceeds the measurement range with the “input error enable” parameter (**Err**) set to OFF (disabled), then the upper or lower limit of the measurement range will be taken as the measurement value. (The display will flash if the “input error enable” parameter is set to OVER (overflow).) A sensor error will not occur in either case and a comparative value judgment will be made on the displayed value. (Comparative results are not based on measurement values shown with dotted lines.)

Parameter Setting Procedure

- | | | |
|-------------------------------------------------------------------------------------------------------------------------------------------------------------------------------------------------------------------------------------------------------------------------------------------------------------------------------------------------|---------------------------------------------------------------------------------------------------|--------------------------------------------------------------------------------------------------------|
| <p>A Press the  [LEVEL] Key for at least 3 s in RUN level to move to the initial setting level.</p> <ul style="list-style-type: none"> • “L” is displayed on the level/bank display to indicate the initial setting level. | 
3 s min. | 
Displays “L”.” |
| <p>B Press the  [LEVEL] Key again (less than 1 s) to move to the input adjustment level and display “L I.”</p> <ul style="list-style-type: none"> • “L I” is displayed on the level/bank display to indicate the input adjustment level. | 
1 s max. | 
Displays “L I.” |
| <p>C Press the  [SHIFT] Key to make the SV display flash.</p> <ul style="list-style-type: none"> • The setting can be changed when the SV display starts to flash. |  |  |
| <p>D Use the  [UP] Key to change the set value.</p> |  |  |
| <p>E Press the  [MODE] Key to switch to the next parameter.</p> <ul style="list-style-type: none"> • The set value is registered. |  |  |
| <p>F Press the  [LEVEL] Key for at least 1 s to return to RUN level.</p> | 
1 s min. |  |

* The display may differ.



Adjusting timing inputs → P.5-33

5.6 Shifting the Temperature Input

Input setting level

H

Input Shift

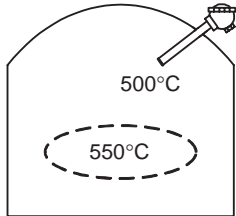

Two points are used to shift the input.

Display and control may not be satisfactory at the present location of the sensor (temperature measurement point) if the temperature at the measurement point and the displayed temperature are significantly different from that of the required location. This can be corrected by setting the difference in temperature between the current display values and the desired values as the input shift values.

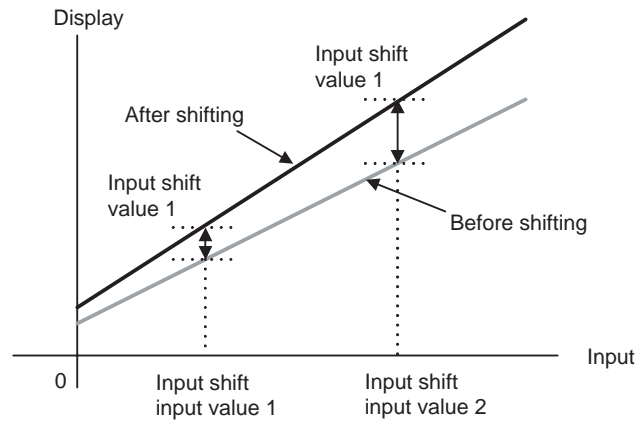
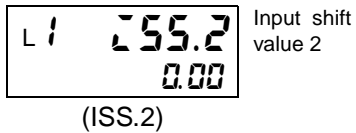
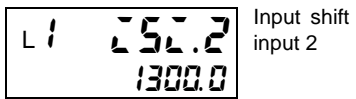
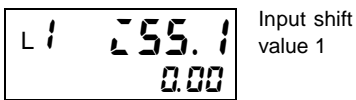
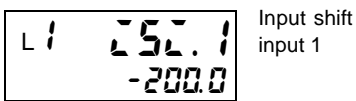

Parameter	Setting range	Initial value
Input shift input 1 252.1	-19999 to 99999	-200.0
Input shift input 2 252.2	-19999 to 99999	1300.0
Input shift value 1 255.1	-199.99 to 999.99	0.00
Input shift value 2 255.2	-199.99 to 999.99	0.00

The shift is linear because there are two separate settings. The shift for the input value set for the “input shift input 1” parameter is set for the “input shift value 1” parameter. The shift for the input value set for the “input shift input 2” parameter is set for the “input shift value 2” parameter. The angle of the slope before and after shifting may be different because different shift values can be set for the “input shift value 1” and “input shift value 2” parameters.

Parameter Setting Procedure

A Press the  [LEVEL] Key for at least 3 s in RUN level to move to the initial setting level.



3 s min.

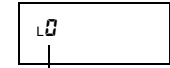

Displays "L0."

- "L0" is displayed on the level/bank display to indicate the initial setting level.

B Press the  [LEVEL] Key for less than 1 s in initial setting level to move to the input adjustment level.





1s max.



- "L1" is displayed on the level/bank display to indicate the initial setting level.

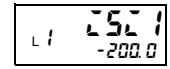

C Press the  [MODE] Key several times to change the PV display to "55.1".



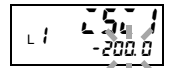

D Press the  [SHIFT] Key to make the SV display flash.

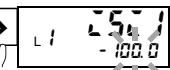

- The setting can be changed when the SV display starts to flash.

E Use the  [UP] and the  [SHIFT] Keys to change the set value.



F Press the  [MODE] Key to switch the PV display to "55.1".

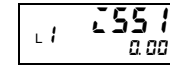

G Repeat steps D through F to set "55.1", "55.2" and "55.2".

5.7 Resetting Measurements

X V S H

When the RESET input turns ON or the \diamond [MAX/MIN] Key is pressed for at least 1 s, the maximum value, minimum value, and outputs are cleared. Measurement is not performed during RESET input.

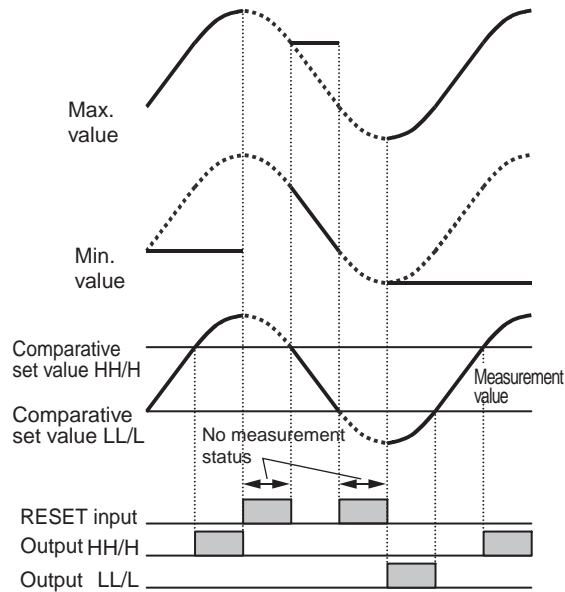

- The display during RESET input is "-----" and all outputs are OFF.
- HOLD and TIMING inputs are accepted, but measurement is disabled during RESET input.
- The RESET input is disabled during "SErr."



Not performing measurements for set intervals → P.5-27

5.8 Not Performing Measurements for Set Intervals

Advanced function setting level

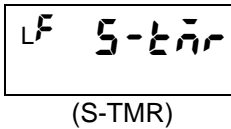

With this function measurement is not performed until a set time has passed after the S-TMR input turns ON. (Timing starts at the rising edge of the S-TMR input and the PV display is “-----” while no measurement has been performed.)

If the power is turned ON while the 5-tAr input is ON, measurement will not start until the time set in the 5-tAr elapses.

This can be used when detecting motor overloads or to ignore motor inrush currents.

Parameter	Set value	Meaning of set value
Startup compensation timer 5-tAr	0.0	Startup compensation timer disabled
	0.1 to 99.9	0.1 to 99.9 s

Parameter Setting Procedure

- A** Press the [LEVEL] Key for at least 3 s in RUN level to move to the initial setting level.



3 s min.

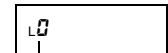

Displays “L0.”

- “L0” is displayed on the level/bank display to indicate the initial setting level.

- B** Press the [MODE] Key several times to change the PV display to “PArAr.”

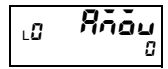

- This parameter is not displayed for the initial status due to setting level protect. Refer to "Limiting Key Operations" (P.5-102) for information on removing setting level protect.

- C** Press the [SHIFT] Key to make the SV display flash.



- The setting can be changed when the SV display starts to flash.

- D** Use the [UP] and [SHIFT] Keys to set the password “-0 159.” Press the [MODE] Key to move to the advanced function setting level.

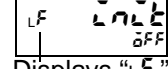
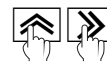







Displays “LF.”

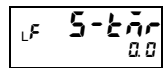

- “LF” is displayed on the level/bank display to indicate the advanced function setting level.

- E** Press the [MODE] Key several times to change the PV display to “5-tAr.”



- F** Press the  [SHIFT] Key to make the SV display flash.
- The setting can be changed when the SV display starts to flash.
- G** Use the  [UP] and  [SHIFT] Keys to change the set value.
- H** Press the  [MODE] Key to switch to the next parameter.
- The set value is registered.
- I** Press the  [LEVEL] Key for at least 1 s to return to the initial setting level.
- 1 s min.
- J** Press the  [LEVEL] Key for at least 1 s to return to RUN level.
- 1 s min.

- S-TMR processing takes priority even if the TIMING input turns ON while the S-TMR input is ON.



Resetting measurements → P.5-26

5.9 Selecting Operations for Input Errors Advanced function setting level

X V S H

LF 5.Err

(S.ERR)

The display and operation when the input is exceeding input range can be selected by setting this parameter.

(Refer to "Input Characteristics" (P.A-6) for input ranges.)

Parameter	Set value	Meaning of set value
Operation at input error 5.Err	OFF	Disabled
	Overflow	Overflow
	5.Err	Input error

Each operation is outlined below.

● Disabled

Display	Outputs
The display is fixed at the measurement value that corresponds to the upper or lower limit of the input range. (The display doesn't flash.)	Outputs correspond to the fixed display value.

● Overflow

Display	Outputs
The display is fixed and flashes at the measurement value that corresponds to the upper or lower limit of the input range.	Outputs correspond to the fixed display value.

● Input error

Display	Outputs
Error display flashes*	All outputs are turned OFF.

* The errors are "Overflow" or "b.Err" for the K3HB-S and "5.Err" for the K3HB-X/V/H.

Parameter Setting Procedure

- A** Press the [LEVEL] Key for at least 3 s in RUN level to move to the initial setting level.





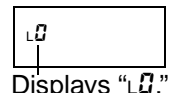







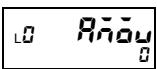









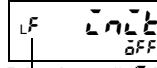

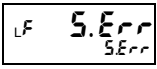

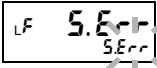
3 s min.

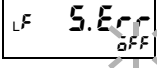

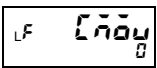
Displays "L0."

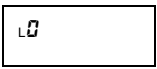
- "L0" is displayed on the level/bank display to indicate the initial setting level.

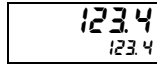
- | | | |
|-----------------------------------------------------------------------------------------------------------------------------------------------------------------------------------------------------------------------------------------------------------------------------------------------------------------------------------------------------------------------------------------------------------------------------------------------------------------------------------------------------------------------------------------------------------|----------------------------------------------------------------------------------------------------------------------------------------------------------------------------------------------------------------------------------------------------------------|-------------------------------------------------------------------------------------------------------|
| <p>B Press the  [MODE] Key several times to change the PV display to "P.L.O.U."</p> <ul style="list-style-type: none"> This parameter is not displayed for the initial status due to setting level protect. Refer to "Limiting Key Operations" (P.5-102) for information on removing setting level protect. |  ... |  |
| <p>C Press the  [SHIFT] Key to make the SV display flash.</p> <ul style="list-style-type: none"> The setting can be changed when the SV display starts to flash. |  |  |
| <p>D Use the  [UP] and  [SHIFT] Keys to set the password "-0 159." Press the  [MODE] Key to move to the advanced function setting level.</p> <ul style="list-style-type: none"> "LF" is displayed on the level/bank display to indicate the advanced function setting level. |  
 | 
Displays "LF." |
| <p>E Press the  [MODE] Key several times to switch the PV display to "S.Err."</p> |  ... |  |
| <p>F Press the  [SHIFT] Key to make the SV display flash.</p> <ul style="list-style-type: none"> The setting can be changed when the SV display starts to flash. |  |  |
| <p>G Use the  [UP] Key to change the SV display to "OFF."</p> |  |  |
| <p>H Press the  [MODE] Key to switch to the next parameter.</p> <ul style="list-style-type: none"> The set value is registered. |  |  |
| <p>I Press the  [LEVEL] Key for at least 1 s to return to the initial setting level.</p> | 
1 s min. |  |
| <p>J Press the  [LEVEL] Key for at least 1 s to return to RUN level.</p> | 
1 s min. |  |



Setting input types → P.5-11

5.10 Disabling Cold Junction Compensation

Advanced function setting level

H

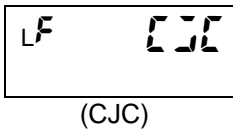

This function disables cold junction compensation (terminal temperature compensation).

Parameter	Set value	Meaning of set value
Cold junction compensation 0.00	0.00	Room temperature display (enabled)
	0.00F	0.0°C (disabled)

Parameter Setting Procedure

- A** Press the [LEVEL] Key for at least 3 s in RUN level to move to the initial setting level.



3 s min.



Displays "L0."

- "L0" is displayed on the level/bank display to indicate the initial setting level.

- B** Press the [MODE] Key several times to change the PV display to "P000.0."

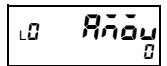

- This parameter is not displayed for the initial status due to setting level protect. Refer to "Limiting Key Operations" (P.5-102) for information on removing setting level protect.

- C** Press the [SHIFT] Key to make the SV display flash.



- The setting can be changed when the SV display starts to flash.

- D** Use the [UP] and [SHIFT] Keys to set the password "-0 159." Press the [MODE] Key to move to the advanced function setting level.

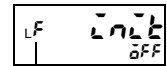
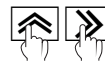







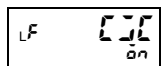





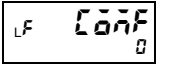

Displays "LF."

- "LF" is displayed on the level/bank display to indicate the advanced function setting level.

- E** Press the [MODE] Key several times to change the PV display to "0.00."

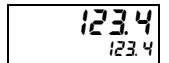

- | | | |
|----------------------------------------------------------------------------------------------------------------------------------------------------------------------------------|-------------------------------------------------------------------------------------|-------------------------------------------------------------------------------------|
| <p>F Press the  [SHIFT] Key to make the SV display flash.</p> |  |  |
| <ul style="list-style-type: none"> • The setting can be changed when the SV display starts to flash. | | |
| <p>G Use the  [UP] Key to change the set value to "OFF."</p> |  |  |
| <p>H Press the  [MODE] Key to switch to the next parameter.</p> |  |  |
| <ul style="list-style-type: none"> • The set value is registered. | | |
| <p>I Press the  [LEVEL] Key for at least 1 s to return to the initial setting level.</p> |  |  |
| | <p>1 s min.</p> | |
| <p>J Press the  [LEVEL] Key for at least 1 s to return to RUN level.</p> |  |  |
| | <p>1 s min.</p> | |

5.11 Adjusting Timing Inputs

Input adjustment level

X V S H

L I $\bar{a}n-t$

(ON-T)

L I $\bar{a}FF-t$

(OFF-T)

Applicable models:

K3HB-□□□

+

- K35-1
- K35-2
- K35-3
- K35-4

TIMING inputs can be delayed by adjusting the ON timing delay and OFF timing delay.

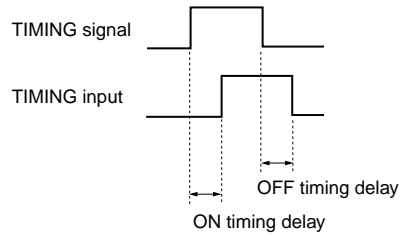

Parameter	Set value	Meaning of set value
ON timing delay $\bar{a}n-t$	0 to 4999	0 to 4,999 ms (0 to 499.9 s*)
OFF timing delay $\bar{a}FF-t$	0 to 4999	0 to 4,999 ms (0 to 499.9 s*)

* The unit for K3HB-X/V/H settings is 100 ms. For example, if 10 is set, then the delay is 10 x 100 ms = 1 s.

The $\bar{a}n-t$ (ON timing delay) and $\bar{a}FF-t$ (OFF timing delay) settings can be used for the timing hold set values as shown in the following table.

Timing hold set value	$t\bar{a}L-H$	ON timing delay $\bar{a}n-t$	OFF timing delay $\bar{a}FF-t$
Normal	$n\bar{a}Rt$	—	—
Sampling hold	S-H	●	—
Peak hold	P-H	●	●
Bottom hold	b-H	●	●
Peak-to-peak hold	P-P	●	●

●: Setting possible, —: Setting not possible

Explanation of Functions ON timing delay, OFF timing delay

The following example shows K3HB-S settings for an ON timing delay of 20 ms and an OFF timing delay of 10 ms.

● Timing Hold Set Value Set to Sampling Hold

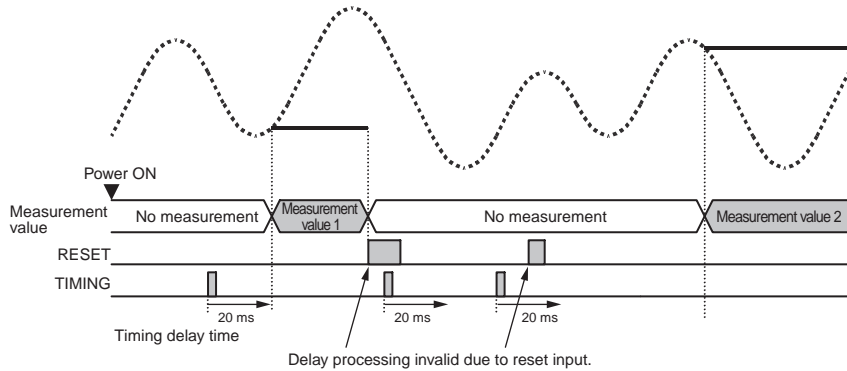

● Timing Hold Set Value Set to Peak Hold

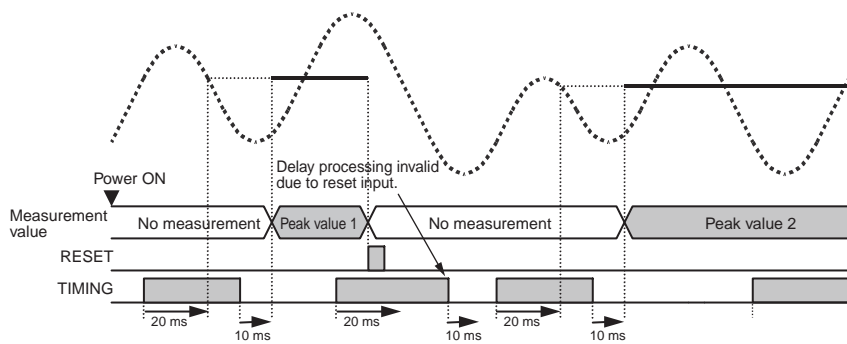

Parameter Setting Procedure

A Press the [LEVEL] Key for at least 3 s in RUN level to move to the initial setting level.

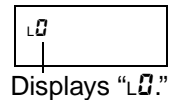

- "L0" is displayed on the level/bank display to indicate the initial setting level.

B Press the [LEVEL] Key again (less than 1 s) to move to the input adjustment level.

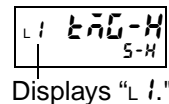













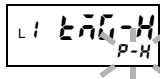











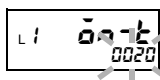



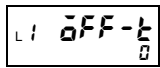

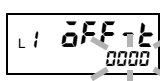

- "L 1" is displayed on the level/bank display to indicate the input adjustment level.

C Press the [SHIFT] Key to make the SV display flash.

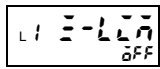

- The setting can be changed when the SV display starts to flash.

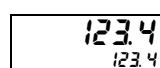
- D** Use the  [UP] and  [SHIFT] Keys to set the timing hold parameter.
-   
- E** Press the  [MODE] Key several times to switch the PV display to “”.
-  ... 
- F** Press the  [SHIFT] Key to make the SV display flash.
- The setting can be changed when the SV display starts to flash.
-  
- G** Use the  [UP] and  [SHIFT] Keys to change the ON timing delay time.
- Units: ms for the K3HB-S,
100 ms for the K3HB-X/V/H
-   
- H** Press the  [MODE] Key to switch the PV display to the next parameter “”.
- The parameter “” is registered.
-  
- I** Press the  [SHIFT] Key to make the SV display flash.
- The setting can be changed when the SV display starts to flash.
-  
- J** Use the  [UP] and  [SHIFT] Keys to change the timing delay.
- Units: ms for the K3HB-S,
100 ms for the K3HB-X/V/H
-   
- K** Press the  [MODE] Key to switch to the next parameter.
- The set value is registered.
-  
- L** Press the  [LEVEL] Key for at least 1 s to return to RUN level.
-  
1 s min.

5.12 Eliminating Drift Near “0”

Input adjustment level

The zero limit function makes all measurement values “0” for inputs lower than a set value.

Explanation of Functions	Zero-limit
--------------------------	------------

If the input value is less than the set value, the measurement value becomes “0.” This function is effective to eliminate display drift and displacement near “0.”

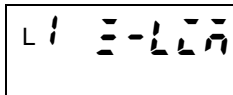

(Z-LIM)

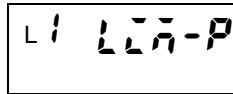

(LIM-P)

Set the following parameter for zero-limit. The zero-limit value can be set only when zero-limit has been enabled.

Parameter	Set value	Meaning of set value
Zero-limit 0-0.00	0n/0FF	on: Enabled off: Disabled
Zero-limit value 0.00-P	0 to 99	0 to 99 *

* The decimal point depends on the “decimal point position” setting.

Parameter Setting Procedure

- A** Press the [LEVEL] Key for at least 3 s in RUN level to move to the initial setting level.

3 s min.

Displays “L I.”

 - “L I” is displayed on the level/bank display to indicate the initial setting level.

- B** Press the [LEVEL] Key again once (less than 1 s) to move to the input adjustment level.

Less than 1 s

Displays “L I.”

 - “L I” is displayed on the level/bank display.

- C** Press the [MODE] Key several times to switch the PV display to “0-0.00.”

- D** Press the [SHIFT] Key to make the SV display flash.

 - The setting can be changed when the SV display starts to flash.

- E** Use the [UP] Key to change the set value to “0n.”

 - Change the set value to “0FF” to disable the setting.



- F** Press the [MODE] Key to switch to the next parameter “0.00-P.”

 - The set value is registered.

G Press the  [SHIFT] Key to make the SV display flash.

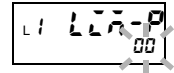
- The setting can be changed when the SV display starts to flash.



H Use the  [UP] and  [SHIFT] Key to change the zero-limit value.

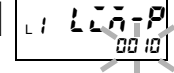
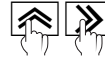

I Press the  [MODE] Key to switch to the next parameter.

- The set value is registered.

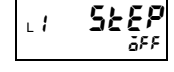

J Press the  [LEVEL] Key for at least 1 s to return to RUN level.

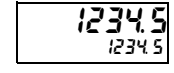

1 s min.

5.13 Averaging Inputs

Input adjustment level



The averaging function smooths the displays and outputs for input values with dramatic fluctuations, such as spike noise.

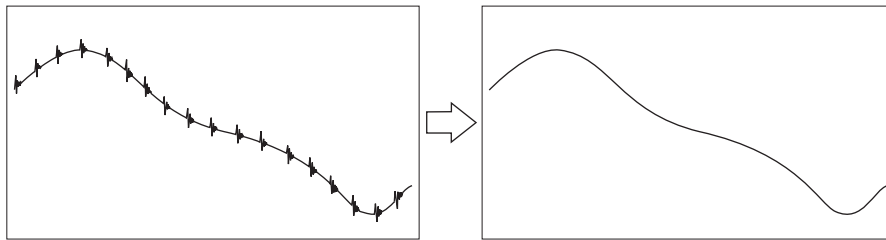

Explanation of Functions Average processing

There are two types of averaging: “simple” and “moving.” Select one type. The number of samples (“averaging times”) can also be specified for the input values to be averaged.

Simple average is used when the display refresh period is to be lengthened. Moving average is used to remove periodic noise superimposed on input signals. For example, with the K3HB-S, the relationship between the data refresh periods for both simple and moving averages when the averaging times is set to 4 is shown below.

● **Simple Average**

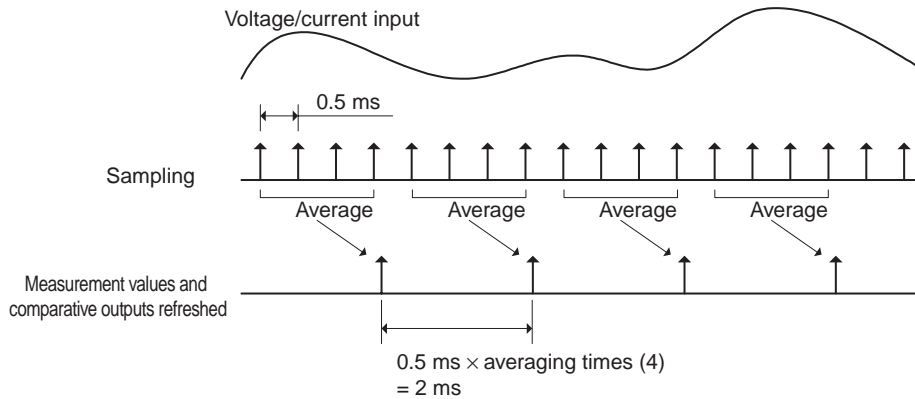

● **Moving Average**

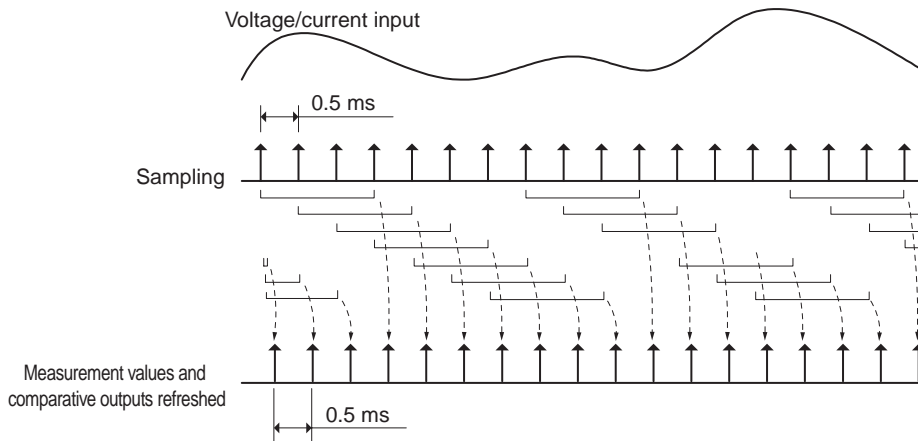

- The data refresh periods when averaging is used are given by model in the following table.

	Set value	K3HB-X/V/H	K3HB-S
No averaging	1	20 ms	0.5 ms
Simple average	2	40 ms	1 ms
	4	80 ms	2 ms
	8	160 ms	4 ms
	16	320 ms	8 ms
	32	640 ms	16 ms
	64	1.28 s	32 ms
	128	2.56 s	64 ms
	256	5.12 s	128 ms
	512	10.24 s	256 ms
Moving average	1024	20.48 s	512 ms
	1 to 1024	20 ms	0.5 ms

L 1 AVG-t

(AVG-T)

L 1 AVG-n

(AVG-N)

Averaging is set using the following parameters.

Parameter	Set value	Meaning of set value
Average type AVG-t	Simple	Simple average
	Moving	Moving average
Averaging times AVG-n	1	1
	2	2
	4	4
	8	8
	16	16
	32	32
	64	64
	128	128
	256	256
	512	512
1024	1024	

* To not use averaging, set the average type "AVG-t" to Simple and the averaging times "AVG-n" to 1.

Parameter Setting Procedure

- A** Press the [LEVEL] Key for at least 3 s in RUN level to move to the initial setting level.





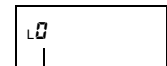







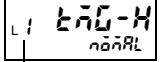

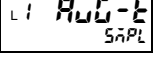

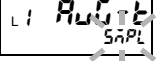

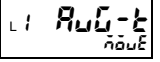

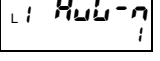

3 s min.

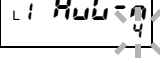

Displays "L0."

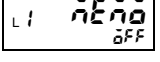
- "L0" is displayed on the level/bank display to indicate the initial setting level.

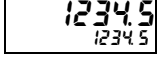
- | | | |
|------------------------------------------------------------------------------------------------------------------------------------------------------------------------------------------------------------------------------------------------------------------------------------------------------------------------------|------------------------------------------------------------------------------------------------------|--------------------------------------------------------------------------------------------------------|
| <p>B Press the  [LEVEL] Key once (less than 1 s) to move to the input adjustment level.</p> <ul style="list-style-type: none"> • “L I” is displayed on the level/bank display to indicate the input adjustment level. | 
Less than 1 s | 
Displays “L I.” |
| <p>C Press the  [MODE] Key several times to switch the PV display to “AUG-t.”</p> |  ... |  |
| <p>D Press the  [SHIFT] Key to make the SV display flash.</p> <ul style="list-style-type: none"> • The setting can be changed when the SV display starts to flash. |  |  |
| <p>E Use the  [UP] Key to change the average type setting.</p> |  |  |
| <p>F Press the  [MODE] Key to change to the next parameter “AUG-n.”</p> <ul style="list-style-type: none"> • The average type setting is registered. |  |  |
| <p>G Press the  [SHIFT] Key to make the SV display flash.</p> |  |  |
| <p>H Use the  [UP] Key to change the averaging times setting.</p> |  |  |
| <p>I Press the  [MODE] Key to switch to the next parameter.</p> <ul style="list-style-type: none"> • The averaging times setting is registered. |  |  |
| <p>J Press the  [LEVEL] Key for at least 1 s to return to RUN level.</p> | 
1 s min. |  |



Changing display refresh periods → P.5-73

5.14 Detecting Sudden Input Changes

Advanced function setting level

X V S H

The previous average value comparison function can be used to detect only sudden changes in input signals.

Explanation of Functions	Previous average value comparison
--------------------------	-----------------------------------

Use the previous average value comparison to not detect gentle changes and only detect sudden changes.

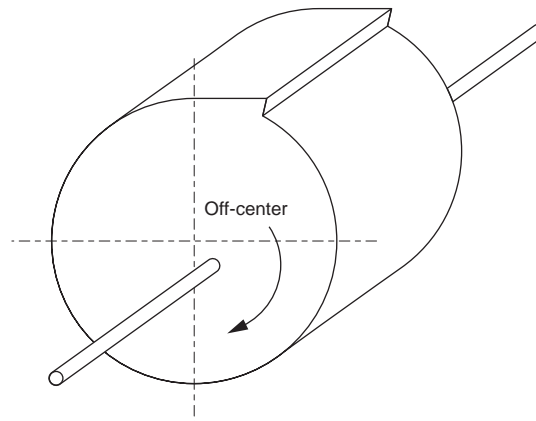

As shown in the above diagram, when rotating a cylindrical object and measuring the distance from the object using a laser displacement meter, it cannot be judged if the increase in measurement values when the rotating axis is eccentric is due to the eccentricity or to a burr.

● Measurement Values

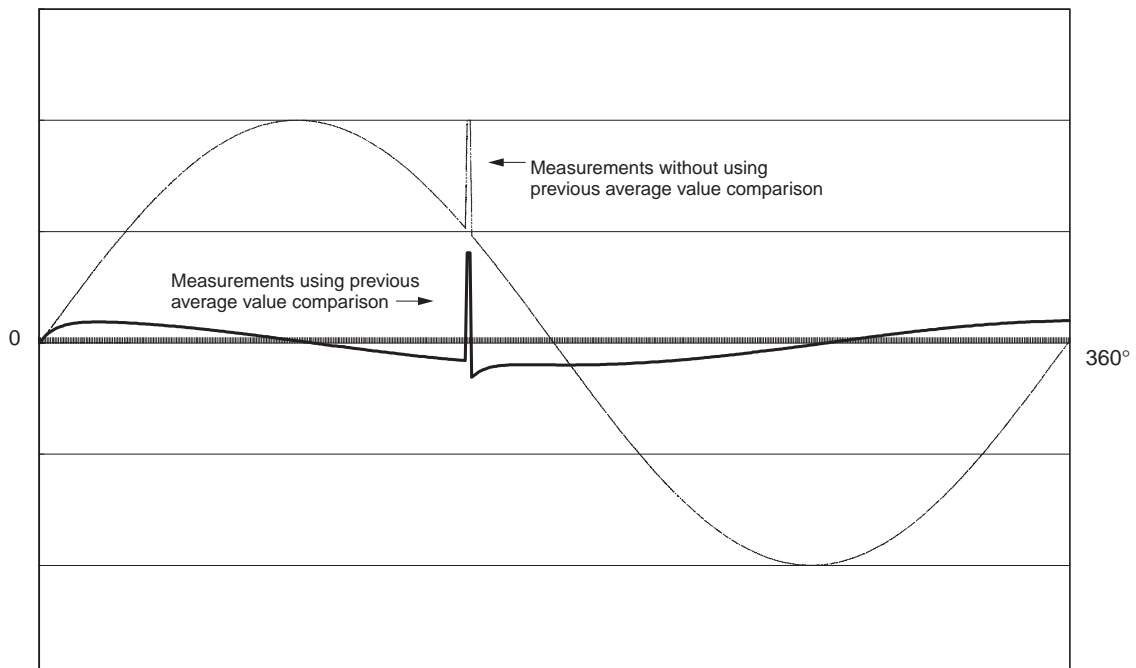

Previous average value comparison makes the measurement value the difference between the present input value and the average of all previous input values.

Number of measurements	Input value	Display value	Comparative set value for next input
1	V ₁	V ₁ -V ₁ =0	C ₁ =V ₁
2	V ₂	V ₂ -C ₁	$C_2 = \frac{1}{2} (C_1 + V_2) = \frac{1}{2} (V_1 + V_2)$
3	V ₃	V ₃ -C ₂	$C_3 = \frac{1}{2} (C_2 + V_3) = \frac{1}{4} (V_1 + V_2) + \frac{1}{2} V_3$
4	V ₄	V ₄ -C ₃	$C_4 = \frac{1}{2} (C_3 + V_4) = \frac{1}{8} (V_1 + V_2) + \frac{1}{4} V_3 + \frac{1}{2} V_4$
⋮	⋮	⋮	⋮
n	V _n	V _n -C _{n-1}	$C_n = \frac{1}{2^{n-1}} (V_1 + V_2) + \frac{1}{2^{n-2}} V_3 + \dots + \frac{1}{2} V_n$

(V_n indicates the input value and C_n indicates the comparative set value used for the next input.)

* Previous average value comparison is performed on confirmed measurement values.

- When the timing hold is set to Normal, the comparison is performed every time.
- When the timing hold is set to a setting other than Normal, the comparison is performed on held values.

Previous average value comparison is set using the following parameter.

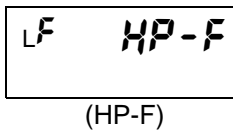

Parameter	Set value	Meaning of set value
Previous average value comparison HP-F	OFF	Previous average value comparison disabled
	ON	Previous average value comparison enabled

Parameter Setting Procedure

A Press the [LEVEL] Key for at least 3 s in RUN level to move to the initial setting level.

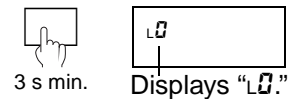

- "LF" is displayed on the level/bank display to indicate the initial setting level.

B Press the [MODE] Key several times to change the PV display to "RnOn."

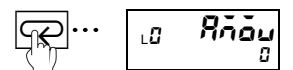

- This parameter is not displayed for the initial status due to setting level protect. Refer to "Limiting Key Operations" (P.5-102) for information on removing setting level protect.

C Press the [SHIFT] Key to make the SV display flash.

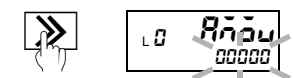

- The setting can be changed when the SV display starts to flash.

- D** Use the [UP] and [SHIFT] Keys to set the password “-0 159.” Press the [MODE] Key to move to the advanced function setting level.

 - “LF” is displayed on the level/bank display to indicate the advanced function setting level.
- E** Press the [MODE] Key to change the PV display to “HP-F.”
- F** Press the [SHIFT] Key to make the SV display flash.

 - The setting can be changed when the SV display starts to flash.
- G** Use the [UP] Key to change the set value.
- H** Press the [MODE] Key to switch to the next parameter.

 - The set value is registered.
- I** Press the [LEVEL] Key for at least 1 s to return to the initial setting level.
- J** Press the [LEVEL] Key for at least 1 s to return to RUN level.



Compensating forced-zero references → P.5-70
 Delaying output OFF timing → P.5-52
 Holding already output comparative outputs → P.5-55

Example of Previous Average Value Comparison for Sampling Hold

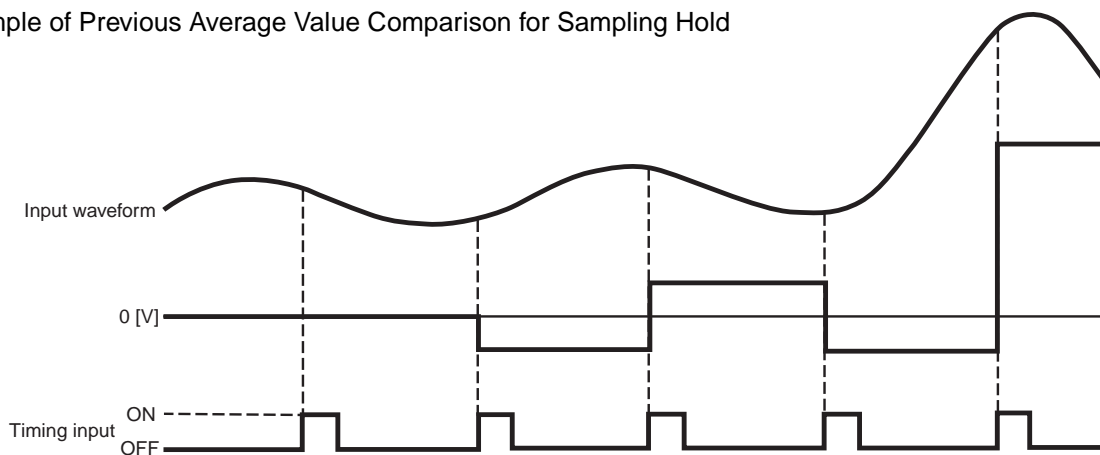

Number of measurements	Input value	Display value	Comparative value for the next input
1	4.0	4.0-4.0=0	4.0
2	3.0	3.0-4.0=-1.0	$\frac{1}{2} (4.0+3.0)=3.5$
3	4.5	4.5-3.5=1.0	$\frac{1}{2} (3.5+4.5)=4.0$
4	3.0	3.0-4.0=-1.0	$\frac{1}{2} (4.0+3.0)=3.5$
5	8.5	8.5-3.5=5.0	$\frac{1}{2} (3.5+8.5)=6.0$

5.15 Changing Comparative Output Patterns Initial setting level

X V S H

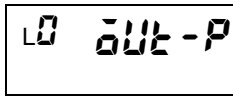

(OUT-P)

This function compares the measurement value and comparative set value and outputs the comparative result. The output pattern is set using the following parameter.

Parameter	Set value	Meaning of set value
Comparative output pattern OUT-P	標準	Standard output
	ゾーン	Zone output
	レベル	Level output

● Standard Output

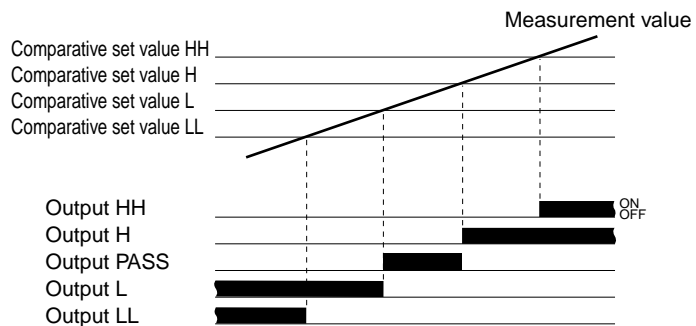

● Zone Output

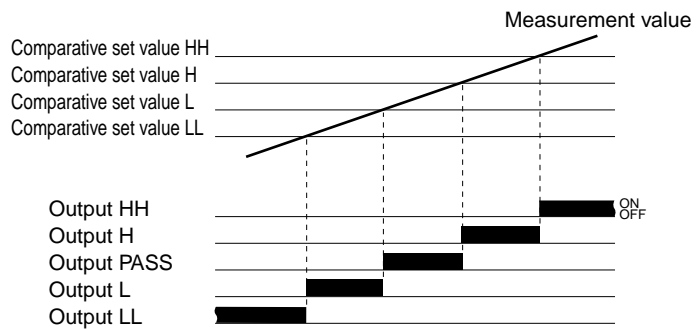

● Level Output

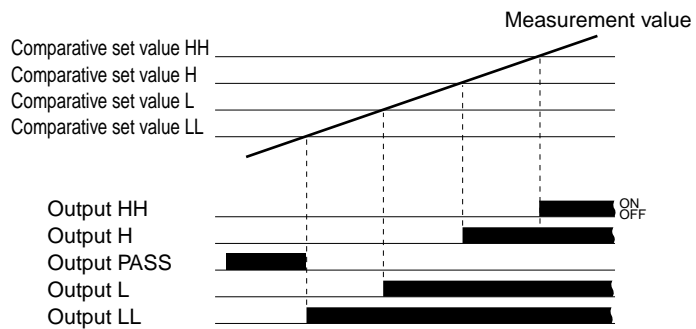

* The PASS output turns ON when any of the HH, H, L, or LL output turns OFF.

Parameter Setting Procedure

A Press the  [LEVEL] Key for at least 3 s in RUN level to move to the initial setting level.

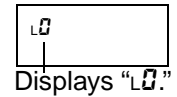

- "LD" is displayed on the level/bank display to indicate the initial setting level.

B Press the  [MODE] Key several times to change the PV display to "out-P."



C Press the  [SHIFT] Key to make the SV display flash.



- The setting can be changed and the SV display starts to flash.

D Use the  [UP] Key to change the set value.



E Press the  [MODE] Key to switch to the next parameter.



- The set value is registered.

F Press the  [LEVEL] Key for at least 1 s to return to RUN level.

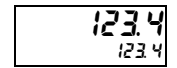

Remarks

Preventing output chattering → P.5-46

Delaying output OFF timing → P.5-52

Outputting at set intervals → P.5-49

Reversing output logic → P.5-59

Holding already output comparative outputs → P.5-55

Performing output tests → P.5-90

Allocating other outputs to PASS output → P.5-57

5.16 Preventing Output Chattering

Advanced function setting level

X V S H

Chattering of a comparative output results from drift in the measurement value near the comparative set value. Chattering can be prevented by adjusting the hysteresis value.

Explanation of Functions | Hysteresis

Hysteresis is a range between the value for which a comparative output turns ON and the value for which the comparative output turns OFF. When the comparative output turns ON, it turns OFF only after the change in measurement values is greater than the set hysteresis.

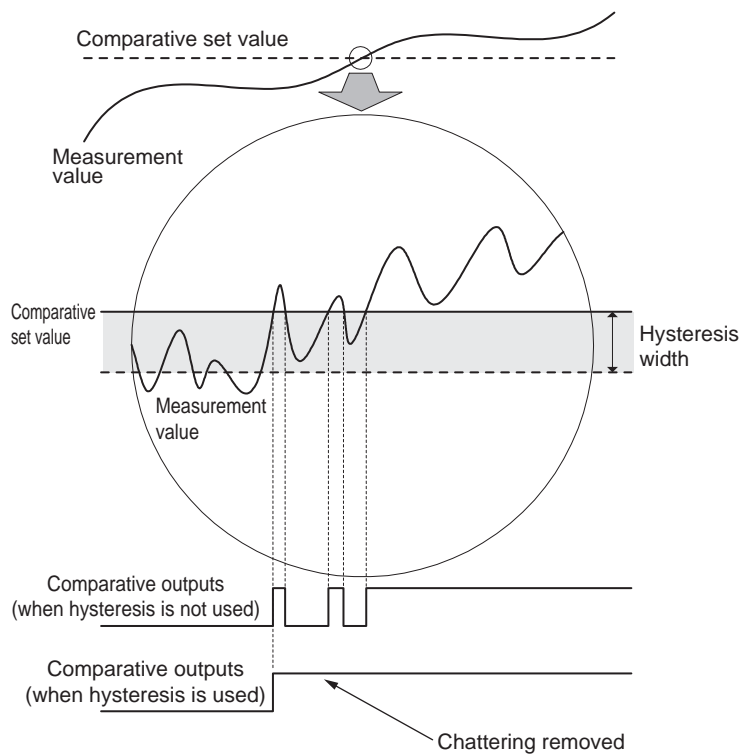

Hysteresis works in the direction of decreasing measurement values for comparative set values HH and H and works in the direction of increasing measurement values for comparative set values LL and L. However, hysteresis works in the direction of decreasing measurement values for all set values if the output pattern is set to a level output.

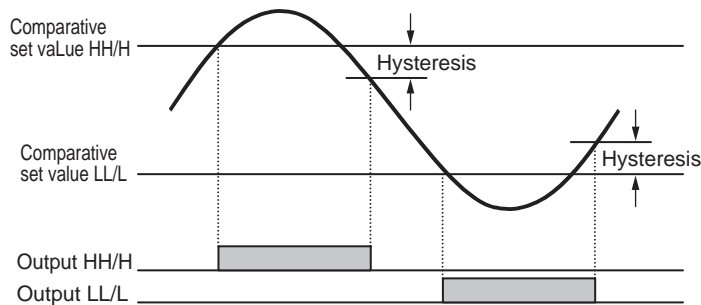

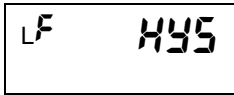

(HYS)

Hysteresis is set using the following parameter.

Parameter	Set value	Meaning of set value
Hysteresis HYS	0 to 9999	0 to 9,999 *

* The decimal point depends on the "decimal point position" setting.

Parameter Setting Procedure

- A** Press the [LEVEL] Key for at least 3 s in RUN level to move to the initial setting level.

• "L0" is displayed on the level/bank display to indicate the initial setting level.

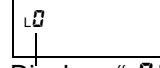

3 s min.

Displays "L0."

- B** Press the [MODE] Key several times to change the PV display to "R000."

• This parameter is not displayed for the initial status due to setting level protect.
Refer to "Limiting Key Operations" (P.5-102) for information on removing setting level protect.

...



- C** Press the [SHIFT] Key to make the SV display flash.



• The setting can be changed when the SV display starts to flash.







- D** Use the [UP] and [SHIFT] Keys to set the password "-0 159." Press the [MODE] Key to move to the advanced function setting level.

• "LF" is displayed on the level/bank display to indicate the advanced function setting level.

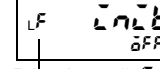
Displays "LF."

- E** Press the [MODE] Key several times to change the PV display to "HYS."

...

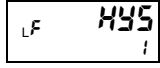

- F** Press the [SHIFT] Key to make the SV display flash.

• The setting can be changed when the SV display starts to flash.



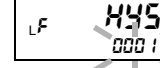







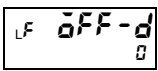

- G** Use the [UP] and [SHIFT] Keys to change the set value.



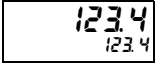

- | | | |
|------------------------------------------------------------------------------------------------------------------------------------------------------------------------------------------------------------------------------------------|-------------------------------------------------------------------------------------------------|-------------------------------------------------------------------------------------|
| <p>H Press the  [MODE] Key to switch to the next parameter.</p> <ul style="list-style-type: none"> • The set value is registered. |  |  |
| <p>I Press the  [LEVEL] Key for at least 1 s to return to the initial setting level.</p> | 
1 s min. |  |
| <p>J Press the  [LEVEL] Key for at least 1 s to return to RUN level.</p> | 
1 s min. |  |

5.17 Outputting for a Set Interval

Advanced function setting level

X V S H

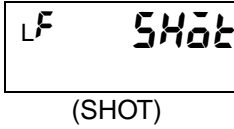

The shot output function turns OFF a comparative output after a set interval after it turns ON. The following diagram shows operation when the shot output is set to 10 ms on the K3HB-S.

● **Timing Hold Set to Normal**

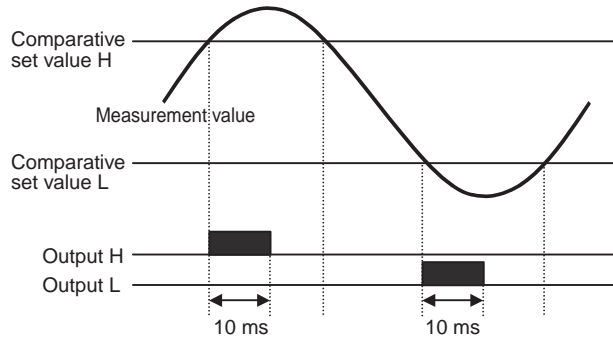

● **Timing Hold Not Set to Normal**

Outputs at the measurement refresh timing if the comparative result is ON. (Even if the comparative result is the same as the previous time, the output is made again at the refresh timing.)

This function can be used to count the number of errors and for similar applications because an output is made at each refresh timing.

Example: Sampling hold

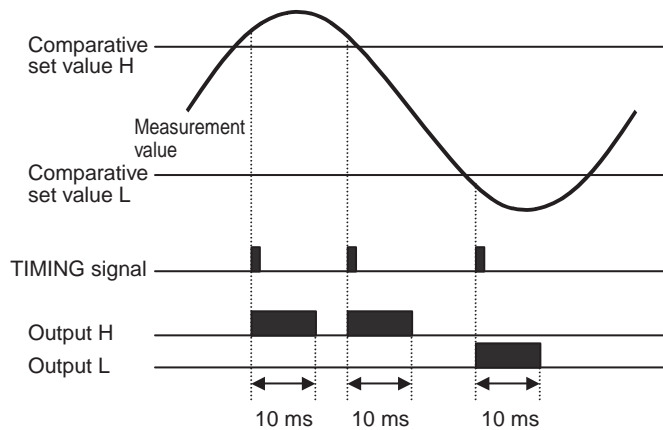

The shot output time is set using the following parameter.













Parameter	Set value	Meaning of set value
Shot output SHOt	0 to 1999	0 to 1,999 ms (0 to 199.9 s)*

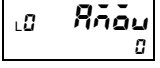









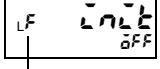

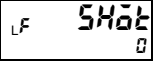

* The unit for K3HB-X/V/H settings is 100 ms. For example, if 10 is set, then the shot output time is 10 x 100 ms = 1 s.

The shot output time is an internal calculation time. The following times are added to the set time to give the actual output time.

- For relay outputs: 11 ms max.
- For transistor outputs: 1 ms max.

Parameter Setting Procedure

- | | | |
|-------------------------------------------------------------------------------------------------------------------------------------------------------------------------------------------------------------------------------------------------------------------------------------------------------------------------------------------------------------------------------------------------------------------------------------------------------------------------------------------------------------------------------------------------------------|-----------------------------------------------------------------------------------------------------------------------------------------------------------------------------------|--------------------------------------------------------------------------------------------------------|
| <p>A Press the  [LEVEL] Key for at least 3 s in RUN level to move to the initial setting level.</p> <ul style="list-style-type: none"> • “L0” is displayed on the level/bank display to indicate the initial setting level. | 
3 s min. | 
Displays “L0.” |
| <p>B Press the  [MODE] Key several times to change the PV display to “R000.”</p> <ul style="list-style-type: none"> • This parameter is not displayed for the initial status due to setting level protect. Refer to "Limiting Key Operations" (P.5-102) for information on removing setting level protect. |  ... |  |
| <p>C Press the  [SHIFT] Key to make the SV display flash.</p> <ul style="list-style-type: none"> • The setting can be changed when the SV display starts to flash. |  |  |
| <p>D Use the  [UP] and  [SHIFT] Keys to set the password “-0 159.” Press the  [MODE] Key to move to the advanced function setting level.</p> <ul style="list-style-type: none"> • “LF” is displayed on the level/bank display to indicate the advanced function setting level. | 

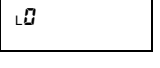
 | 
Displays “LF.” |
| <p>E Press the  [MODE] Key several times to change the PV display to “5H00.”</p> |  ... |  |
| <p>F Press the  [SHIFT] Key to make the SV display flash.</p> <ul style="list-style-type: none"> • The setting can be changed when the SV display starts to flash. |  |  |
| <p>G Use the  [UP] and  [SHIFT] Keys to change the set value.</p> |  |  |
| <p>H Press the  [MODE] Key to switch to the next parameter.</p> <ul style="list-style-type: none"> • The set value is registered. |  |  |
| <p>I Press the  [LEVEL] Key for at least 1 s to return to the initial setting level.</p> | 
1 s min. |  |

Important

Set the shot output time (5H00) to “0” to use the OFF delay (0FF-d). If set to anything else, 0FF-d (OFF delay) will be disabled.

J Press the [LEVEL] Key for at least 1 s to return to RUN level.



1 s min.

123.4
123.4



Delaying output OFF timing → P.5-52

5.18 Delaying Output OFF Timing

Advanced function setting level



The output OFF delay function delays the OFF timing for comparative results.

The shot output (SHōt) is given priority over the OFF delay (ōFF-d). The OFF delay will be disabled if the shot output is set to anything other than "0," regardless of the OFF delay setting.

Explanation of Functions	Output OFF delay
--------------------------	------------------

If the measurement value changes and the comparative result that had been ON until now turns OFF, the comparative output will be held for the time set for the output OFF delay parameter.

The comparative output ON time may be too short if measurement values change quickly. When comparative output signals are read by external devices, short signals may not be received properly. In such situations, the output OFF delay can be used to output comparative output signal values for a set duration or greater.

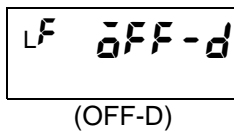

Output OFF delay is set using the following parameter.

Parameter	Set value	Meaning of set value
Output OFF delay ōFF-d	0 to 1999	0 to 1,999 ms (0 to 199.9 s)*

* The unit for K3HB-X/V/H settings is 100 ms. For example, if 10 is set, then the output OFF delay is 10 x 100 ms = 1 s.

Parameter Setting Procedure

A Press the [LEVEL] Key for at least 3 s in RUN level to move to the initial setting level.

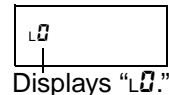

- "L0" is displayed on the level/bank display to indicate the initial setting level.

B Press the [MODE] Key several times to change the PV display to "P000."

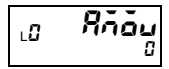

- This parameter is not displayed for the initial status due to setting level protect. Refer to "Limiting Key Operations" (P.5-102) for information on removing setting level protect.

C Press the [SHIFT] Key to make the SV display flash.



- The setting can be changed when the SV display starts to flash.

- | | | |
|------------------------------------------------------------------------------------------------------------------------------------------------------------------------------------------------------------------------------------------------------------------------------------------------------|--------------|--------------------|
| <p>D Use the [UP] and [SHIFT] Keys to set the password “-0 159.” Press the [MODE] Key to move to the advanced function setting level.</p> <ul style="list-style-type: none"> • “LF” is displayed on the level/bank display to indicate the advanced function setting level. |
 |
Displays “LF.” |
| <p>E Press the [MODE] Key several times to change the PV display to “OFF-d.”</p> | | |
| <p>F Press the [SHIFT] Key to make the SV display flash.</p> <ul style="list-style-type: none"> • The setting can be changed when the SV display starts to flash. | | |
| <p>G Use the [UP] and [SHIFT] Keys to change the set value.</p> | | |
| <p>H Press the [MODE] Key to switch to the next parameter.</p> <ul style="list-style-type: none"> • The set value is registered. | | |
| <p>I Press the [LEVEL] Key for at least 1 s to return to the initial setting level.</p> |
1 s min. | |
| <p>J Press the [LEVEL] Key for at least 1 s to return to RUN level.</p> |
1 s min. | |



Outputting at set intervals → P.5-49
 Holding already output comparative outputs → P.5-55

5.19 Holding Measurement Status

X V S H

Measurement values, maximum values, minimum values, and output status can be held while the HOLD input is ON.

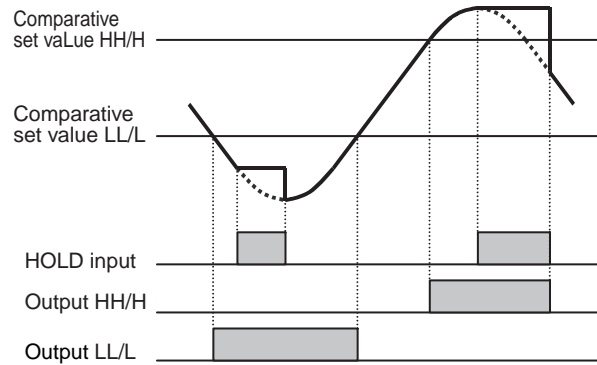

- The measurement value is held when the HOLD input turns ON.
- When the HOLD input turns OFF, the measurement value at that time is restored.
- During HOLD input, signals other than RESET input and bank number selection using bank selection are not accepted.
- If the HOLD input turns ON in no measurement status, when a sensor error has occurred, or when there is an overflow, the status at that time is held.
- Forced-zero is not accepted during HOLD input.

5.20 Holding Comparative Outputs

Advanced function setting level

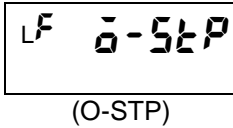

The comparative output hold function holds the status of all outputs after any output except for the PASS output turns ON, i.e., it stops refreshing outputs. You can choose to stop outputs and continue measurement, or to stop both.

Outputs will be refreshed again after the reset operation.

- Resetting measurements → P.5-26

● Example with Output Refresh Stop ON

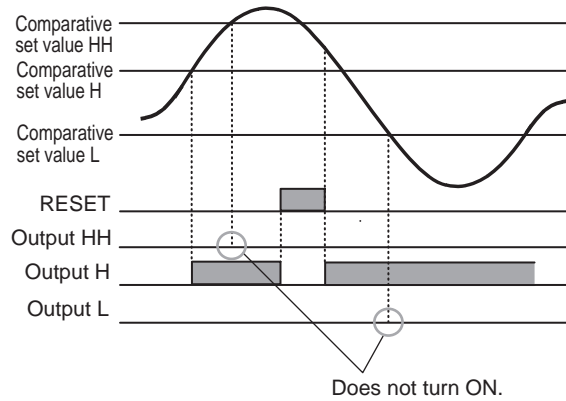

Parameter	Set value	Meaning of set value	
		Outputs	Measurement
Output refresh stop ā-5tP	āh	Continue	Continue
	āFF	Stop	Continue
	RLl	Stop	Stop

Parameter Setting Procedure

A Press the [LEVEL] Key for at least 3 s in RUN level to move to the initial setting level.

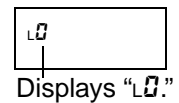





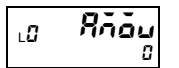





- "L0" is displayed on the level/bank display to indicate the initial setting level.

B Press the [MODE] Key several times to change the PV display to "Rāōu."



- This parameter is not displayed for the initial status due to setting level protect. Refer to "Limiting Key Operations" (P.5-102) for information on removing setting level protect.

- C** Press the  [SHIFT] Key to make the SV display flash.
- The setting can be changed when the SV display starts to flash.
- D** Use the  [UP] and  [SHIFT] Keys to set the password “-0 159.” Press the  [MODE] Key to move to the advanced function setting level.
- “LF” is displayed on the level/bank display to indicate the advanced function setting level.
- E** Press the  [MODE] Key several times to change the PV display to “0-STEP.”
- F** Press the  [SHIFT] Key to make the SV display flash.
- The setting can be changed when the SV display starts to flash.
- G** Use the  [UP] Key to change the set value.
- H** Press the  [MODE] Key to switch to the next parameter.
- The set value is registered.
- I** Press the  [LEVEL] Key for at least 1 s to return to the initial setting level.
- 1 s min.
- J** Press the  [LEVEL] Key for at least 1 s to return to RUN level.
- 1 s min.

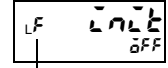

Displays “LF.”

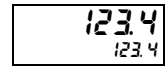
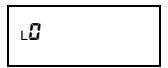
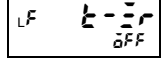
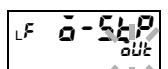
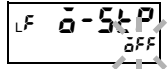
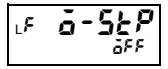

5.21 Allocating Another Output to PASS Output

Advanced function setting level

X V S H

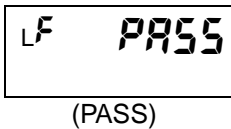

The “PASS output change” parameter can be set to output a comparative output or error output from the PASS output terminal instead of outputting the PASS output. This function is valid only when there is a PASS output terminal.

In the default settings, PASS signals are output from the PASS output terminal.

Parameter	Set value	Meaning of set value
PASS output change <i>PASS</i>	LL	LL
	L	L
	<i>PASS</i>	PASS
	H	H
	HH	HH
	<i>Err</i>	Input error*

* The output turns ON when an input error occurs. To allocate input errors to the PASS output, set the “input error enable” parameter to *5.Err*. If input error enable is set to *OFF* or *auErr*, there is no output because there is no input error.

- Setting the “operation at input error” parameter to *5.Err* → P.5-29

* If *Err* is allocated, P will light when *Err* is displayed.

Parameter Setting Procedure

A Press the [LEVEL] Key for at least 3 s in RUN level to move to the initial setting level.



3 s min.

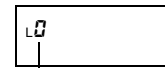

Displays “LD.”

- “LD” is displayed on the level/bank display to indicate the initial setting level.

B Press the [MODE] Key several times to change the PV display to “*9999*.”

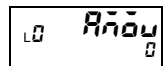















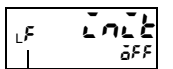



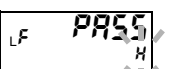

- This parameter is not displayed for the initial status due to setting level protect. Refer to “Limiting Key Operations” (P.5-102) for information on removing setting level protect.

C Press the [SHIFT] Key to make the SV display flash.

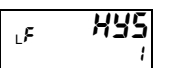

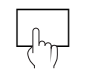
- The setting can be changed when the SV display starts to flash.

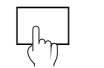
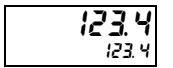
- | | | |
|--------------------------------------------------------------------------------------------------------------------------------------------------------------------------------------------------------------------------------------------------------------------------------------------------------------------------------------------------------------------------------------------------------|-------------------------------------------------------------------------------------------------------------------------------------------------------------------------------------------------------------------------------------------------------------------|--------------------------------------------------------------------------------------------------------|
| <p>D Use the  [UP] and  [SHIFT] Keys to set the password “-0 159.” Press the  [MODE] Key to move to the advanced function setting level.</p> | 

 | 
Displays “L F.” |
| <p>E Press the  [MODE] Key to change the PV display to “PASS.”</p> |  |  |
| <p>F Press the  [SHIFT] Key to make the SV display flash.</p> |  |  |
| <p>G Use the  [UP] Key to change the set value.</p> |  |  |
| <p>H Press the  [MODE] Key to switch to the next parameter.</p> |  |  |
| <p>I Press the  [LEVEL] Key for at least 1 s to return to the initial setting level.</p> | 
1 s min. |  |
| <p>J Press the  [LEVEL] Key for at least 1 s to return to RUN level.</p> | 
1 s min. |  |

5.22 Reversing Output Logic

Advanced function setting level

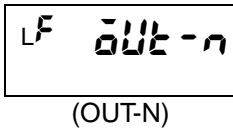
X V S H



The output logic reversal function sets the logic of comparative outputs for comparative results.

Parameter	Set value	Operation		
		Comparative result	Comparative output status	Comparative output
Output logic OUT-N	Close in alarm n-d	ON	ON	ON
		OFF	OFF	OFF
	Open in alarm n-l	ON	ON	OFF
		OFF	OFF	ON*

The comparative outputs will turn OFF if an input error occurs when "open in alarm" is set.

* Turns OFF when an input error occurs.

Parameter Setting Procedure

A Press the [LEVEL] Key for at least 3 s in RUN level to move to the initial setting level.

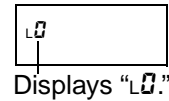

Displays "LD."

- "LD" is displayed on the level/bank display to indicate the initial setting level.

B Press the [MODE] Key several times to change the PV display to "RnOu."



- This parameter is not displayed for the initial status due to setting level protect. Refer to "Limiting Key Operations" (P.5-102) for information on removing setting level protect.

C Press the [SHIFT] Key to make the SV display flash.







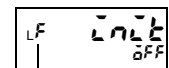





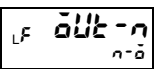

- The setting can be changed when the SV display starts to flash.

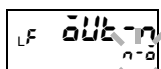
D Use the [UP] and [SHIFT] Keys to set the password "-0 159." Press the [MODE] Key to move to the advanced function setting level.

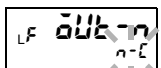

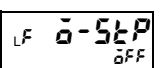
Displays "LF."

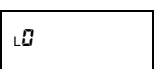
- "LF" is displayed on the level/bank display to indicate the advanced function setting level.

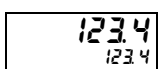
- | | | |
|---------------------------------------------------------------------------------------------------------------------------------------------------------------------------------------------------------------------------------------------------------------------------|--------------------------------------------------------------------------------------------------|--------------------------------------------------------------------------------------|
| <p>E Press the  [MODE] Key several times to change the PV display to "oUt-n."</p> |  ... |  |
| <p>F Press the  [SHIFT] Key to make the SV display flash.</p> <ul style="list-style-type: none"> • The setting can be changed when the SV display starts to flash. |  |  |
| <p>G Use the  [UP] Key to change the set value.</p> |  |  |
| <p>H Press the  [MODE] Key to switch to the next parameter.</p> <ul style="list-style-type: none"> • The set value is registered. |  |  |
| <p>I Press the  [LEVEL] Key for at least 1 s to return to the initial setting level.</p> | 
1 s min. |  |
| <p>J Press the  [LEVEL] Key for at least 1 s to return to RUN level.</p> | 
1 s min. |  |

5.23 No Output before PASS Range

Advanced function setting level

X V S H

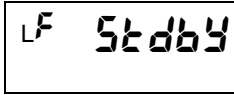

(STDBY)

The standby sequence function can be used to prevent outputs from turning ON for unstable inputs after the power is turned ON. All outputs will remain OFF until the measurement value reaches the PASS value.

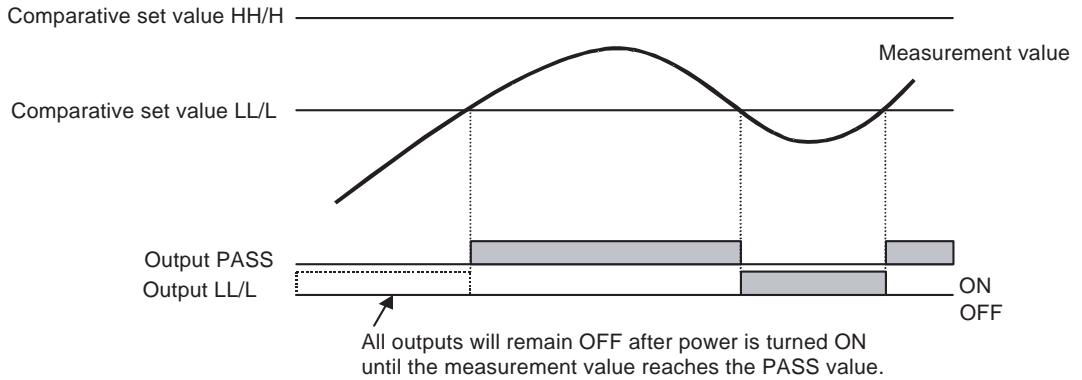

Parameter	Set value	Meaning of set value
Standby sequence StdbY	ōn	Disabled
	ōFF	Enabled

Parameter Setting Procedure

A Press the [LEVEL] Key for at least 3 s in RUN level to move to the initial setting level.



- "LD" is displayed on the level/bank display to indicate the initial setting level.

B Press the [MODE] Key several times to change the PV display to "Pāōm."

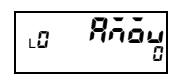













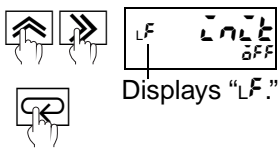

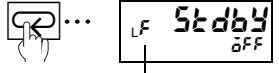
- This parameter is not displayed for the initial status due to setting level protect. Refer to "Limiting Key Operations" (P.5-102) for information on removing setting level protect.

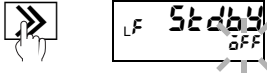
C Press the [SHIFT] Key to make the SV display flash.

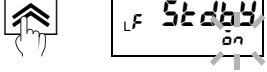

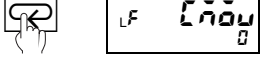
- The setting can be changed when the SV display starts to flash.

Functions and Operations

- D** Use the  [UP] and  [SHIFT] Keys to set the password “-0 159.” Press the  [MODE] Key to move to the advanced function setting level.
- “LF” is displayed on the level/bank display to indicate the advanced function setting level.
- 
- Displays “LF.”
- E** Press the  [MODE] Key several times to change the PV display to “StdbY.”
- 
- Displays “LF.”
- F** Press the  [SHIFT] Key to make the SV display flash.
- The setting can be changed when the SV display starts to flash.
- 
- G** Use the  [UP] Key to change the set value to “0n.”
- Change the set value to “OFF” to turn OFF the standby sequence.
- 
- H** Press the  [MODE] Key to switch to the next parameter.
- The set value is registered.
- 
- I** Press the  [LEVEL] Key for at least 1 s to return to the initial setting level.
- 1 s min.
- 
- J** Press the  [LEVEL] Key for at least 1 s to return to RUN level.
- 1 s min.
- 

5.24 Performing Linear Output

Linear output level

X V S H

L5 LSET.C

(LSET.C)

L5 LSET.V

(LSET.V)

L5 LSET.H

(LSET.H)

L5 LSET.L

(LSET.L)

The linear output function outputs currents or voltages proportional to measurement values as they change.

Select the type of linear output. Set the maximum and minimum output measurement values to output the current or voltage for those measurement values.

Voltage Output

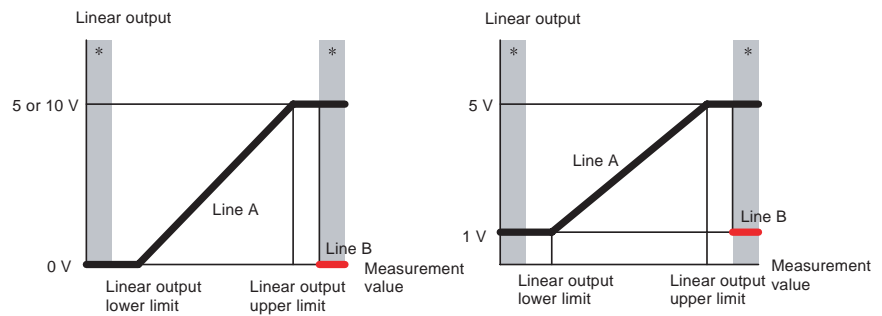

Current Output

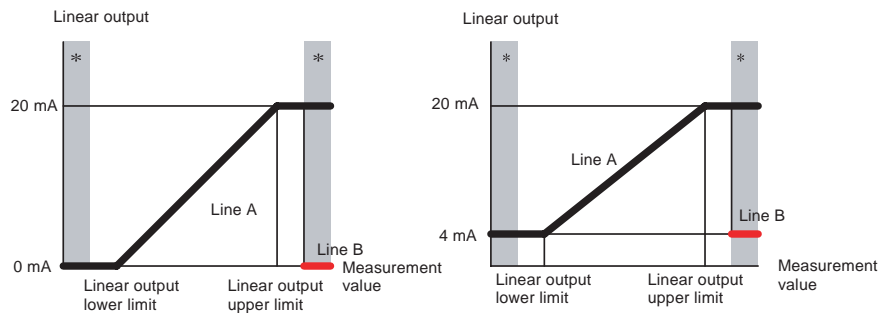

* Areas marked with an asterisk (*) are input error areas. If the “operation at input error” parameter is set to “input error,” then the output would be like Line B. Otherwise, the output would be like Line A.

* If operation stops without performing a measurement, then the minimum value (e.g., 4 mA for the 4 to 20 mA range) is output.

* The value set for the upper limit does not necessarily have to be higher than the value set for the lower limit. The following is an example of reverse scaling.

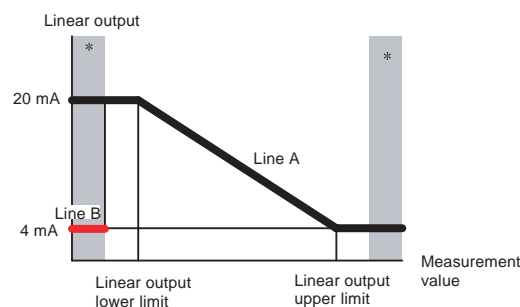

Functions and Operators



* If the upper and lower limit are set to the same value, then the upper limit will equals the lower limit plus 1 for linear output.

Parameter	Set value	Meaning of set value
Linear current type LSEt.I	0-20	0 to 20 mA
	4-20	4 to 20 mA
Linear voltage type LSEt.u	0-5	0 to 5 V
	1-5	1 to 5 V
	0-10	0 to 10 V
Linear output upper limit LSEt.H	-19999 to 99999	-19999 to 99999
Linear output lower limit LSEt.L	-19999 to 99999	-19999 to 99999

* When a linear output is mounted, the “linear current type” or “linear voltage type” parameter can be set according to the type of linear output.

Parameter Setting Procedure

A Press the  [LEVEL] Key for at least 3 s in RUN level to move to the initial setting level.

 3 s min.  Displays “L0.”

- “L0” is displayed on the level/bank display to indicate the initial setting level.

B Press the  [LEVEL] Key once (less than 1 s) or several times to move to the linear output level and display “L5.”

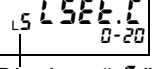
 ...  Displays “L5.”

- “L5” is displayed on the level/bank display to indicate the linear output level.

C Press the  [SHIFT] Key to make the SV display flash.

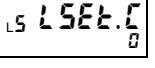
  The setting can be changed when the SV display starts to flash.

D Use the  [UP] Key to change the set value.

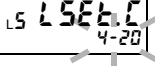
E Press the  [MODE] Key to switch to the next parameter.

  The set value is registered.

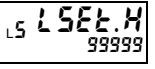
F Press the  [LEVEL] Key for at least 1 s to return to RUN level.

 1 s min. 

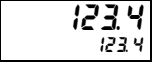
5.25 Setting the Present Measurement Value to “0”



The forced-zero function forces the present measurement value to “0.”

Explanation of Functions	Forced-zero
--------------------------	-------------

This function can be used for applications such as making comparative judgements where the tare or container weight is canceled and only the weight of the contents are used for measurement.

When forced-zero is cleared, the display returns to the actual measurement value.

The changes to measurement values when forced-zero is executed or cleared during measurement are shown below.

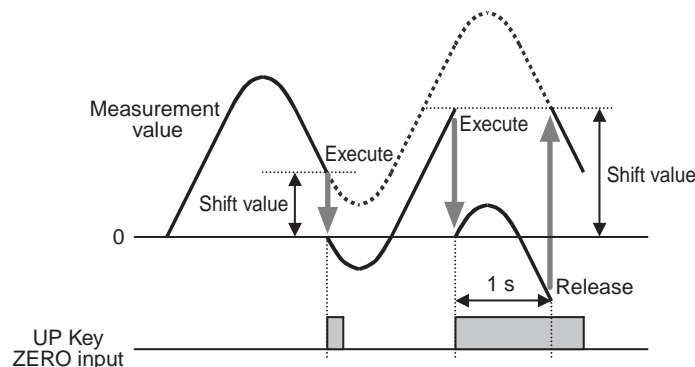

- Maximum and minimum values are not initialized even if forced-zero is executed.
- Forced zero is not possible for maximum or minimum value displays.
- When the display range has been exceeded or a sensor error occurs, forced-zero cannot be executed while no measurement is being performed. (Forced-zero can be cleared but not during RESET input.)
- The forced-zero and forced-zero clear operations are stored in the internal non-volatile memory of the K3HB, so the status is held even if the power supply is turned ON again.

There are two methods for executing and clearing forced-zero: using key operations and using ZERO inputs.

● Using Key Operations

Executing forced-zero: Press the [UP] Key for less than 1 s while the present value is displayed to execute forced-zero.

Clearing forced-zero: Press the [UP] Key for at least 1 s to clear forced-zero.

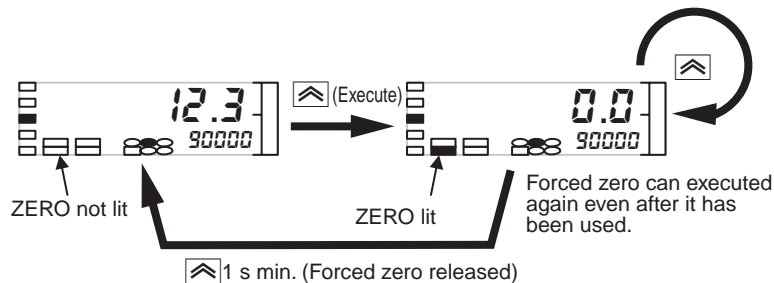

● **Using ZERO Inputs**

Executing forced-zero: Forced-zero is executed on the rising edge of the ZERO input ON signal (when ZERO input is ON for 1 s max.).

Clearing forced-zero: Forced-zero is cleared when ZERO input is ON for 1 s min.



Setting the present measurement value to "0" again using the forced-zero reference → P.5-67
(Tare zero)

Prohibiting key-operated forced-zero → P.5-102
(Key protect)

5.26 Setting the Present Measurement Value to "0" Again when Using a Forced Zero

Advanced function setting level



The tare zero function shifts the present measurement value to "0" again using a forced zero.

Explanation of Functions	Tare zero
--------------------------	-----------

This function is effective when each of two different types of compound are to be weighed, as shown in the following example.

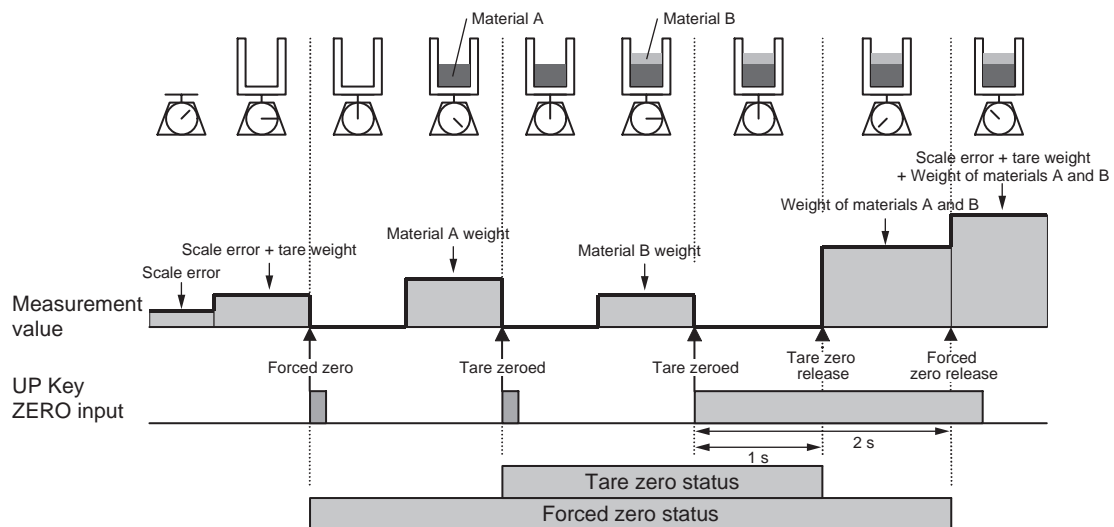

- Information about whether tare zero is being executed or cleared and shift values after tare zero is executed are not stored in memory when the power is turned OFF. If the power is turned OFF during tare zero, the Unit will be in forced-zero status when the power is turned ON again.
- When the display range has been exceeded or a sensor error occurs, tare zero cannot be executed while no measurement is being performed. Forced-zero can be cleared, but not during RESET input.

There are two methods for executing and clearing tare zero: using key operations and using ZERO inputs.

● Using Key Operations

Executing tare zero: Press the [UP] Key while forced-zero is being executed and the present value is displayed to execute tare zero.

Clearing tare zero: Press and hold for 1 s to clear tare zero. (Press it again for 1 s to clear forced-zero.)

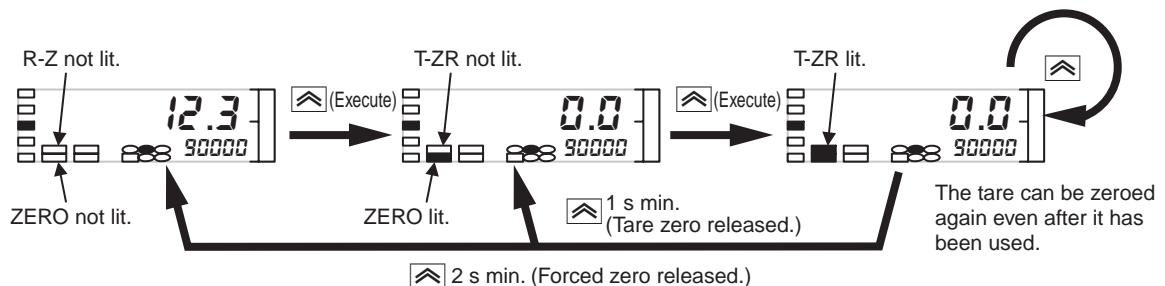

● **Using ZERO Inputs**

Executing tare zero: Tare zero is executed on the rising edge of the ZERO input ON signal during forced-zero execution.

Clearing tare zero: If the ZERO input is ON for 1 s, tare zero is cleared. (Forced-zero is cleared if the ZERO input is ON for a further 1 s.)

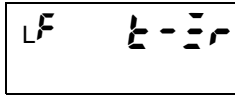

(T-ZR)

Tare zero is set using the following parameter.

Parameter	Set value	Meaning of set value
Tare zero 0.0000	00	Tare zero enabled
	0FF	Tare zero disabled

Parameter Setting Procedure

A Press the [LEVEL] Key for at least 3 s in RUN level to move to the initial setting level.



3 s min.



Displays "LF."

- "LF" is displayed on the level/bank display to indicate the initial setting level.

B Press the [MODE] Key several times to change the PV display to "R000."

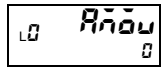

- This parameter is not displayed for the initial status due to setting level protect. Refer to "Limiting Key Operations" (P.5-102) for information on removing setting level protect.

C Press the [SHIFT] Key to make the SV display flash.



- The setting can be changed when the SV display starts to flash.

D Use the [UP] and [SHIFT] Keys to set the password "-0169." Press the [MODE] Key to move to the advanced function setting level.

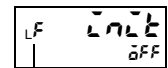
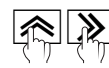

Displays "LF."

- "LF" is displayed on the level/bank display to indicate the advanced function setting level.

E Press the [MODE] Key several times to switch the PV display to "0.0000."

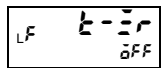

F Press the [SHIFT] Key to make the SV display flash.

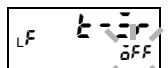

- The setting can be changed when the SV display starts to flash.

G Use the  [UP] Key to change the set value to "0".

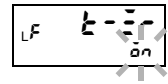

- Change the set value to "0FF" to turn OFF tare zero.

H Press the  [MODE] Key to switch to the next parameter.

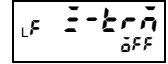

- The set value is registered.

I Press the  [LEVEL] Key for at least 1 s to return to the initial setting level.

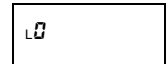

1 s min.

J Press the  [LEVEL] Key for at least 1 s to return to RUN level.

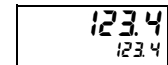

1 s min.



Setting the present measurement value to "0" (forced-zero) → P.5-65

5.27 Compensating Forced-zero References

Advanced function setting level



The zero-trimming function compensates the forced-zero shift value based on the measurement value for an OK object (PASS data) while forced-zero is being executed.

This function can be used if the timing hold setting is set to sampling hold, peak hold, or bottom hold.

Explanation of Functions	Zero-trimming
--------------------------	---------------

The zero-trimming algorithm is shown below.

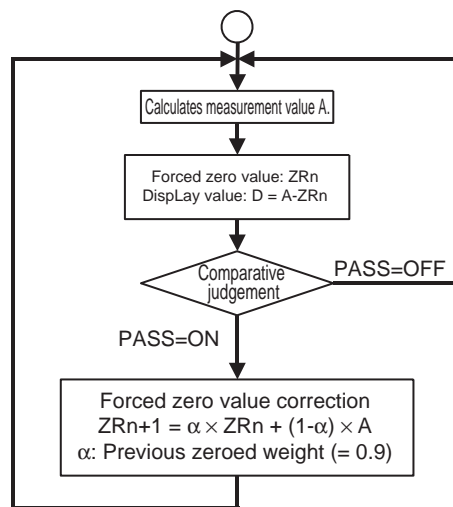

Application Example: Absorbing temperature drift for linear sensors

The reference device is measured using the linear sensor and forced-zero is executed first thing in the morning, when the room temperature is low. While workpieces are subsequently being measured, the room temperature gradually increases and the measurement values gradually change due to the temperature characteristics of the linear sensor.

These kinds of gradual changes can be compensated for by using the zero-trimming function.

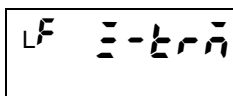













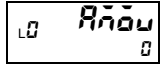







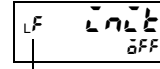

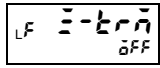
(Z-TRM)

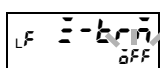
Zero-trimming is set using the following parameter.

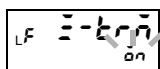
Parameter	Set value	Meaning of set value
Zero-trimming Z-TRM	ON	Zero-trimming ON
	OFF	Zero-trimming OFF

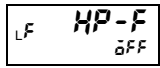
Parameter Setting Procedure

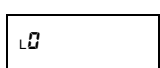
- A** Press the  [LEVEL] Key for at least 3 s in RUN level to move to the initial setting level.
-  3 s min.  Displays "L0."
- "L0" is displayed on the level/bank display to indicate the initial setting level.
- B** Press the  [MODE] Key several times to change the PV display to "P000."
-  ... 
- This parameter is not displayed for the initial status due to setting level protect. Refer to "Limiting Key Operations" (P.5-102) for information on removing setting level protect.
- C** Press the  [SHIFT] Key to make the SV display flash.
-  
- The setting can be changed when the SV display starts to flash.
- D** Use the  [UP] and  [SHIFT] Keys to set the password "-0159." Press the  [MODE] Key to move to the advanced function setting level.
-    Displays "LF."
- "LF" is displayed on the level/bank display to indicate the advanced function setting level.
- E** Press the  [MODE] Key several times to switch the PV display to "0-000."
-  ... 
- F** Press the  [SHIFT] Key to make the SV display flash.
-  
- The setting can be changed when the SV display starts to flash.
- G** Use the  [UP] Key to change the set value to "0FF."
-  
- Change the set value to "0FF" to turn OFF zero-trimming.
- H** Press the  [MODE] Key to switch to the next parameter.
-  
- The set value is registered.
- I** Press the  [LEVEL] Key for at least 1 s to return to the initial setting level.
-  1 s min. 

J Press the [LEVEL] Key for at least 1 s to return to RUN level.



1 s min.

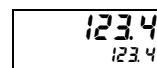

Setting the present measurement value to "0" (forced-zero) → P.5-65

5.28 Changing Display Refresh Periods

Display adjustment level

X V S H

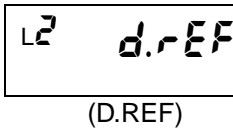

When measurement values change rapidly and the display changes with the measurement values, flickering often occurs and the display becomes difficult to read. The flickering can be suppressed and the display made easier to read in such situations by delaying the display refresh period. The display refresh period is set using the following parameter.

Parameter	Set value	Meaning of set value
Display refresh period <i>d.rEF</i>	<i>0FF</i>	Every 50 ms
	<i>0.5</i>	Every 0.5 s
	<i>1</i>	Every 1 s
	<i>2</i>	Every 2 s
	<i>4</i>	Every 4 s

Parameter Setting Procedure

A Press the [LEVEL] Key for at least 3 s in RUN level to move to the initial setting level.

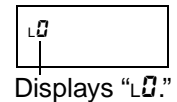

- "L0" is displayed on the level/bank display to indicate the initial setting level.

B Press the [LEVEL] Key several times to move to the display adjustment level.

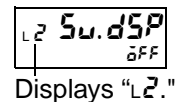

- "L2" is displayed on the level/bank display.

C Press the [MODE] Key to change the PV display to "d.rEF."

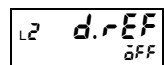

D Press the [SHIFT] Key to make the SV display flash.

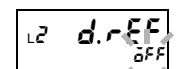

- The setting can be changed when the SV display starts to flash.

E Use the [UP] Key to change the set value.

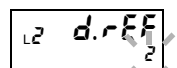

F Press the [MODE] Key to switch to the next parameter.

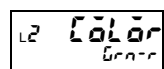

- The set value is registered.

G Press the [LEVEL] Key for at least 1 s to return to RUN level.



1 s min.

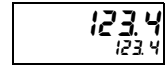

Averaging inputs → P.5-38

Detecting sudden input changes → P.5-41

5.29 Holding Maximum and Minimum Values

X V S H

Each time the \diamond [MAX/MIN] Key is pressed at the RUN level, the maximum and minimum values recorded while a measurement is being performed will be displayed.

- Maximum and minimum values are not affected when forced-zero and tare zero are executed or cleared.

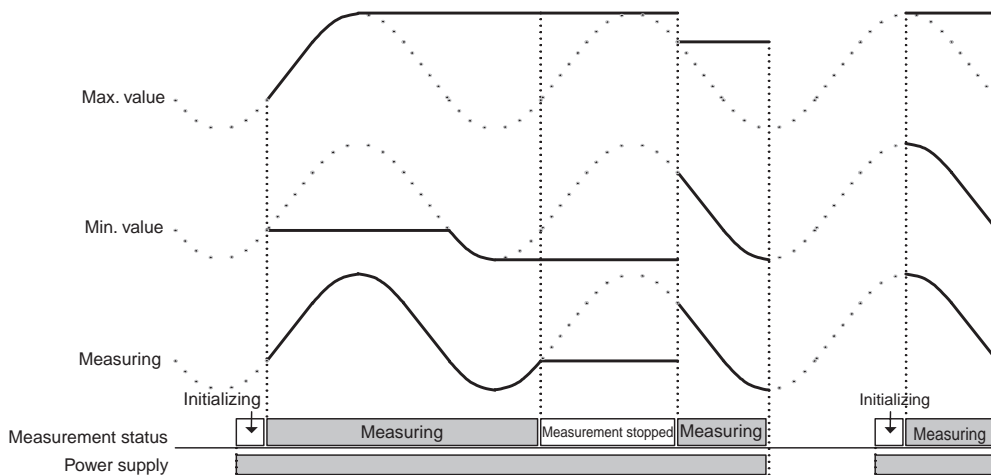

● Switching Maximum and Minimum Value Displays

Each time the \diamond [MAX/MIN] Key is pressed in RUN level, the PV display switches as follows: present value → maximum value → minimum value → present value.

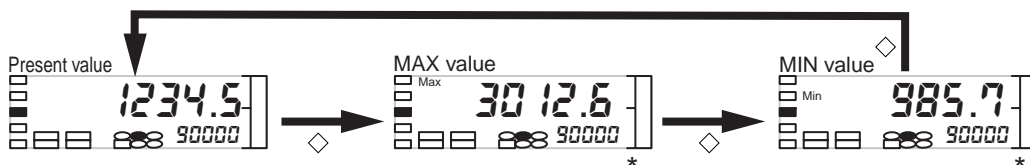

* If input error enable (*5.Err*) is ON and a sensor error occurs, the input error will be displayed on the maximum and minimum display.

The input error is cleared by a RESET input or by pressing the \diamond [MAX/MIN] Key for at least 1 s.

● Power Interruption Memory





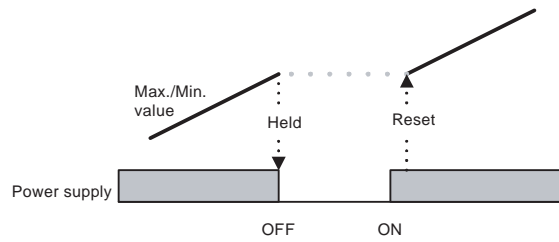









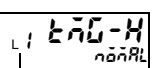

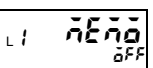
This function can be used to hold the maximum and minimum values during power interruptions. The setting choices are hold and no hold.

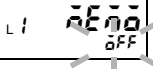
This function can control maximum and minimum value fluctuations even if device power is interrupted.

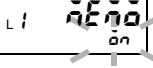

- * Holds values even for no measurement status, an input error, or an overflow.
- * Holds values even with a software reset performed through key operations or communications.
- * The power interruption memory cannot be accessed if the startup compensation timer is enabled when the power is turned ON.

Parameter Setting Procedure

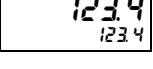
<p>A Press the  [LEVEL] Key for at least 3 s in RUN level to move to the initial setting level.</p> <ul style="list-style-type: none"> • “L 0” is displayed on the level/bank display to indicate the initial setting level. 	 3 s min.	 Displays “L 0.”
<p>B Press the  [LEVEL] Key once (less than 1 s) to move to the input adjustment level.</p> <ul style="list-style-type: none"> • “L 1” is displayed on the level/bank display to indicate the input adjustment level. 	 1 s min.	 Displays “L 1.”
<p>C Press the  [MODE] Key several times to change the PV display to “STEP.”</p>		
<p>D Press the  [SHIFT] Key to make the SV display flash.</p> <ul style="list-style-type: none"> • The setting can be changed when the SV display starts to flash. 		
<p>E Use the  [UP] Key to change the set value.</p>		
<p>F Press the  [MODE] Key to switch to the next parameter.</p> <ul style="list-style-type: none"> • The set value is registered. 		
<p>G Press the  [LEVEL] Key for at least 1 s to return to RUN level.</p>	 1 s min.	



Changing normal display values to maximum and minimum values →
P.5-78

5.30 Changing Normal Display Values to Maximum and Minimum Values

Display adjustment level

X V S H

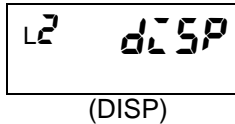

The PV display value displayed after power is turned ON, after the RESET input, immediately after moving to RUN level, and immediately after automatic display return to RUN or adjustment levels can be set to either the present value, maximum value, or minimum value.



The display value selection is set using the following parameter.

Parameter	Set value	Meaning of set value
Display value selection dLSP	Pu	Present value
	nRu	Max. value
	nLn	Min. value

Parameter Setting Procedure

- A** Press the [LEVEL] Key for at least 3 s in RUN level to move to the initial setting level.

• "L0" is displayed on the level/bank display to indicate the initial setting level.

 3 s min.  Displays "L0."
- B** Press the [LEVEL] Key several times to move to the display adjustment level.

• "L2" is displayed on the level/bank display to indicate the display adjustment level.

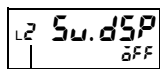
 ...  Displays "L2."
- C** Press the [MODE] Key to change the PV display to "dLSP."

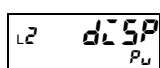
 
- D** Press the [SHIFT] Key to make the SV display flash.

• The setting can be changed when the SV display starts to flash.

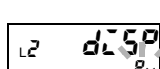
 
- E** Use the [UP] Key to change the set value.

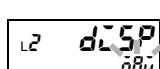
 
- F** Press the [MODE] Key to switch to the next parameter.

• The set value is registered.

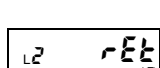
 
- G** Press the [LEVEL] Key for at least 1 s to return to RUN level.

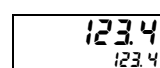
1 s min.  



Displaying/not displaying comparative set values → P.5-82
Using position meters → P.5-85
Changing automatic display return time → P.5-73

5.31 Setting the Step for Changing the Rightmost Digit

Input adjustment level

X V S H

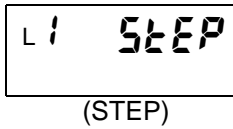

The step for changing the rightmost digit on the display is set using the following parameter.

Parameter	Set value	Meaning of set value
Step value STEP	OFF	Refer to the diagram below.
	2	
	5	
	10	

Measurement value	0	1	2	3	4	5	6	7	8	9	10	
Display values for rightmost digit	Set value OFF	0	1	2	3	4	5	6	7	8	9	10
	Set value 2	0		2		4		6		8		10
	Set value 5	0		5			10					
	Set value 10	0					10					

Parameter Setting Procedure

- A** Press the [LEVEL] Key for at least 3 s in RUN level to move to the initial setting level.

• "L1" is displayed on the level/bank display to indicate the initial setting level.

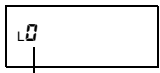
 3 s min.
  Displays "L1."
- B** Press the [LEVEL] Key once (less than 1 s) to move to the input adjustment level.

• "L1" is displayed on the level/bank display to indicate the input adjustment level.

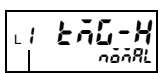
 Less than 1 s
  Displays "L1."
- C** Press the [MODE] Key several times to change the PV display to "STEP."

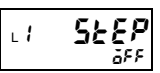

- D** Press the [SHIFT] Key to make the SV display flash.

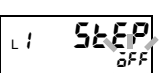
• The setting can be changed and the SV display starts to flash.

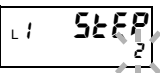

- E** Use the [UP] Key to change the set value.

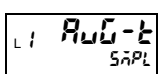

- F** Press the [MODE] Key to switch to the next parameter.

• The set value is registered.

G Press the [LEVEL] Key for at least 1 s to return to RUN level.



1 s min.

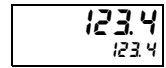

5.32 Displaying/Not Displaying Comparative Set Values

Display adjustment level

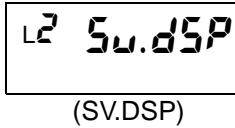

Comparative set values can be displayed or not displayed on the SV display during operation.

This is set using the following parameter.

Parameter	Set value	Meaning of set value
Comparative set value display Sv.dSP	OFF	Comparative set value not displayed.
	ON	Comparative set value displayed.

If “comparative set value display” is set to OFF, the comparative set value display will turn OFF (not be lit) after 10 s in RUN level. The comparative set value is displayed again when any key is pressed.

Parameter Setting Procedure

- A** Press the [LEVEL] Key for at least 3 s in RUN level to move to the initial setting level.

• “L0” is displayed on the level/bank display to indicate the initial setting level.

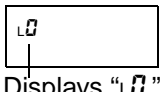
3 s min. Displays “L0.”
- B** Press the [LEVEL] Key several times to move to the display adjustment level.

• “L2” is displayed on the level/bank display to indicate the display adjustment level.

Displays “L2.”
- C** Press the [SHIFT] Key to make the SV display flash.

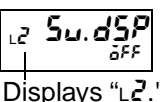
• The setting can be changed when the SV display starts to flash.

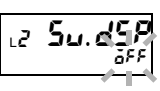

- D** Use the [UP] Key to change the set value.

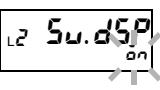

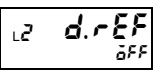
- E** Press the [MODE] Key to switch to the next parameter.

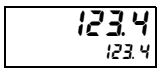
• The set value is registered.



- F** Press the [LEVEL] Key for at least 1 s to return to RUN level.





1 s min.

5.33 Changing Display Colors

Display adjustment level

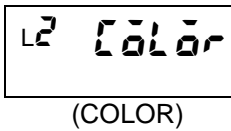
X V S H



The PV display color can be switched when the comparative result changes from PASS to HH, H, L, or LL, or when an input error occurs during operation in RUN, adjustment, or protect levels.

This function is called “display color selection.” The color switching pattern is set using the following parameter.

Parameter	Set value	Status*	PV display color
Display color selection COLOR	Grrr	OFF	Green
		ON	Red
	Grr	OFF	Green
		ON	
	Red-G	OFF	Red
		ON	Green
	Red	OFF	Red
		ON	

* Comparative output HH, H, L, or LL or input error status

OFF: All comparative outputs HH, H, L, and LL are OFF and no input error. (PASS status)

ON: HH, H, L, or LL comparative output is ON or input error. (Not PASS status)

Parameter Setting Procedure

A Press the [LEVEL] Key for at least 3 s in RUN level to move to the initial setting level.



3 s min.



Displays “L0.”

- “L0” is displayed on the level/bank display to indicate the initial setting level.

B Press the [LEVEL] Key several times to move to the display adjustment level.



...

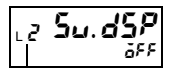

Displays “L2.”

- “L2” is displayed on the level/bank display to indicate the display adjustment level.

C Press the [MODE] Key to change the PV display to “COLOR.”

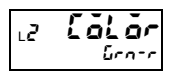



D Press the [SHIFT] Key to make the SV display flash.

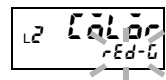

- The setting can be changed when the SV display starts to flash.

E Use the  [UP] Key to change the set value.



F Press the  [MODE] Key to switch to the next parameter.

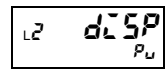

- The set value is registered.

G Press the  [LEVEL] Key for at least 1 s to return to RUN level.

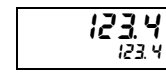

1 s min.



Performing output tests → P.5-90

5.34 Using the Position Meter

Display adjustment level

X V S H

L2 POS-T

(POS-T)

L2 POS-H

(POS-H)

L2 POS-L

(POS-L)

The meter on the right side of the front panel with 20 sections is called the “position meter” and shows the position of the displayed value (present value, maximum, or minimum) in relation to any values set using the position meter upper and lower limits. The position meter upper and lower limits can be set to any range.

The position meter display pattern is set using the following parameter.

Parameter	Set value	Meaning of set value
Position meter type POS-t	OFF	OFF
	INC	Incremental
	INC-r	Incremental (reversed)
	DEV	Deviation (*2)
	DEV-r	Deviation (reversed)
Position meter upper limit POS-H	-9999 to 99999	-19999 to 99999 (*1)
Position meter lower limit POS-L	-9999 to 99999	-19999 to 99999 (*1)

*1. The decimal point depends on the “decimal point position” parameter setting.













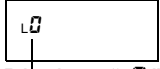

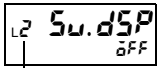

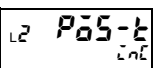



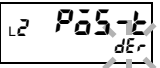

*2. The amount that the displayed value differs from the mid-point between the position meter upper and lower limits (the deviation) is displayed.

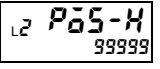
Position meter type	Incremental	Incremental (reversed)	Deviation	Deviation (reversed)
Position meter upper limit				
Position meter lower limit				

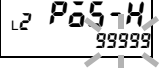
* If the position meter lower limit set value is smaller than the position meter upper limit set value, the top and bottom of the above displays will be reversed.

* The position meter will not be lit if there is an input error.

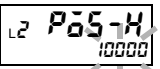

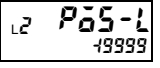
Parameter Setting Procedure

- | | | |
|------------------------------------------------------------------------------------------------------------------------------------------------------------------------------------------------------------------------------------------------------------------------------------------------------------------------------------|-------------------------------------------------------------------------------------------------|-------------------------------------------------------------------------------------------------------|
| <p>A Press the  [LEVEL] Key for at least 3 s in RUN level to move to the initial setting level.</p> <ul style="list-style-type: none"> • “L0” is displayed on the level/bank display to indicate the initial setting level. | 
3 s min. | 
Displays “L0.” |
| <p>B Press the  [LEVEL] Key several times to move to the display adjustment level.</p> <ul style="list-style-type: none"> • “L2” is displayed on the level/bank display to indicate the display adjustment level. |  | 
Displays “L2.” |
| <p>C Press the  [MODE] Key several times to change the PV display to “P05-t.”</p> |  |  |
| <p>D Press the  [SHIFT] Key to make the SV display flash.</p> <ul style="list-style-type: none"> • The setting can be changed when the SV display starts to flash. |  |  |
| <p>E Use the  [UP] Key to change the position meter type setting.</p> |  |  |
| <p>F Press the  [MODE] Key to switch to the next parameter “P05-H.”</p> <ul style="list-style-type: none"> • The parameter for position meter type is registered. |  |  |
| <p>G Press the  [SHIFT] Key to make the SV display flash.</p> <ul style="list-style-type: none"> • The setting can be changed when the SV display starts to flash. |  |  |
| <p>H Use the  [UP] and  [SHIFT] Keys to change the position meter upper limit setting.</p> |  |  |
| <p>I Press the  [MODE] Key to switch to the next parameter “P05-L.”</p> <ul style="list-style-type: none"> • The parameter for the position meter upper limit is registered. |  |  |

J Press the  [SHIFT] Key to make the SV display flash.

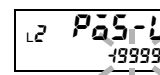
- The setting can be changed when the SV display starts to flash.



K Use the  [UP] and  [SHIFT] Keys to change the position meter lower limit setting.

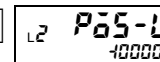

L Press the  [MODE] Key to switch to the next parameter.

- The parameter for the position meter lower limit is registered.

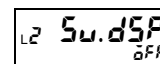

M Press the  [LEVEL] Key for at least 1 s to return to RUN level.

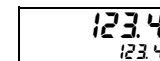

1 s min.

5.35 Automatic Return to Normal Display

Display adjustment level

X V S H

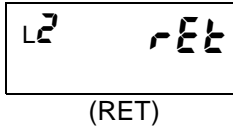

If no keys are operated for a specified time after switching the display in the RUN level or adjustment level, the display will automatically return to the RUN level. The time until the display returns automatically can be set and the automatic display return can be disabled through this setting.

Automatic display return settings are made using the following parameter.

Parameter	Set value	Meaning of set value
Automatic display return rEt	0 to 99	0 to 99 s Automatic display return will not occur if set to 0.

Parameter Setting Procedure

- A** Press the [LEVEL] Key for at least 3 s in RUN level to move to the initial setting level.
- 3 s min. Displays "L0."
- "L0" is displayed on the level/bank display to indicate the initial setting level.
- B** Press the [LEVEL] Key several times to move to the display adjustment level.
- ... Displays "L2."
- "L2" is displayed on the level/bank display to indicate the display adjustment level.
- C** Press the [MODE] Key several times to change the PV display to "rEt."
- ... Displays "rEt."
- D** Press the [SHIFT] Key to make the SV display flash.
- The setting can be changed when the SV display starts to flash.
- E** Use the [UP] and [SHIFT] Keys to change the set value.
- ... Displays "03."
- F** Press the [MODE] Key to switch to the next parameter.
- The set value is registered.
- ... Displays "Pos-t."

G Press the  [LEVEL] Key for at least 1 s to return to RUN level.



1 s min.

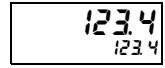

5.36 No Decimal Point Display

Display adjustment level

H



(PVDP)

This function selects whether or not to display values below the decimal point for present values, maximum values, and minimum values.

If no display is selected, then numbers past the decimal point are rounded off to display the nearest integer. Comparative judgments, however, will use the decimal point.

Parameter	Set value	Meaning of set value
Decimal point display <i>PvdP</i>	<i>0n</i>	23.5 (Decimal point display)
	<i>0FF</i>	24 (No decimal point display)

Parameter Setting Procedure

A Press the [LEVEL] Key for at least 3 s in RUN level to move to the initial setting level.

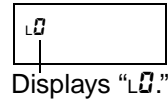

- “L0” is displayed on the level/bank display to indicate the initial setting level.

B Press the [LEVEL] Key several times to move to the display adjustment level.

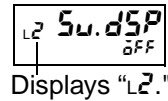

- “L2” is displayed on the level/bank display to indicate the display adjustment level.

C Press the [MODE] Key several times to change the PV display to “PvdP.”

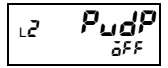

D Press the [SHIFT] Key to make the SV display flash.



- The setting can be changed when the SV display starts to flash.

E Use the [UP] Key to change the position meter type setting.

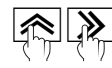

F Press the [MODE] Key to switch to the next parameter.

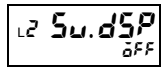

- The set value is registered.

G Press the  [LEVEL] Key for at least 1 s to return to RUN level.



1 s min.

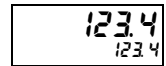

5.37 Performing Output Tests

Output test level

X V S H

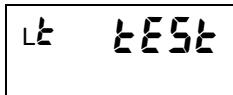

(TEST)

The output test function is used to set test measurement values using the keys to check the comparative outputs against the set comparative set values.

A test measurement value is set using the following parameter.

Parameter	Set value	Meaning of set value
Test input	0FF	Output test disabled
	-19999 to 99999	-19999 to 99999

Parameter Setting Procedure

A Press the [LEVEL] Key for at least 3 s in RUN level to move to the initial setting level.



3 s min.

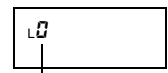

Displays "L0."

- "L0" is displayed on the level/bank display to indicate the initial setting level.

B Press the [LEVEL] Key several times to move to the output test level "L tEST."

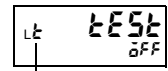

Displays "L tEST."

- "L tEST" is displayed on the level/bank display to indicate the output test level.

C Press the [SHIFT] Key.

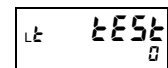

- The test input will be 0 after moving to output test status.

D Use the [UP] and [SHIFT] Keys to change the set value.

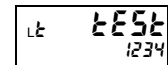
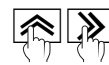

- Use the [UP] Key to increase the set value.
- Use the [SHIFT] Key to decrease the set value.
- Continue pressing the key to quickly increase or decrease the set value.

E Once the output test has finished, press the [LEVEL] Key for at least 1 s to return to RUN level.



1 s min.

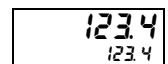

5.38 Using Comparative Set Value Banks

Advanced function setting level/Comparative set value level

X V S H

The K3HB has 8 banks where groups of comparative set values can be set beforehand. Comparative set values can be changed easily by switching these banks. This function is called “bank selection.”

Explanation of Functions	Bank selection
--------------------------	----------------

Comparative set values HH, H, L, and LL are set in groups to banks. Comparative set values can be set to all 8 banks, numbered 0 to 7. Banks can be selected using front panel keys or an event input.

* If the bank copy function is used, the comparative set values set to one bank can be copied to all banks.

■ 1. Specifying the Bank Selection Method

LF **bnP-ζ**

(BNK-C)

Applicable models:

K3HB-□□□

+

K35-2

K35-4

Before banks can be selected, the bank selection method must be specified. The bank selection function is enabled when the selection method is specified. The individual bank settings cannot be made until bank selection is enabled.

The bank selection method is set using the following parameter.

Parameter	Set value	Meaning of set value
Bank selection bnP-ζ	OFF	Bank selection disabled
	KEY	Bank selection using keys (*1)
	EU	Bank selection using event input (*2)

*1. With this setting, banks cannot be selected using event inputs.





















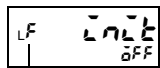

*2. With this setting, banks cannot be selected using key operations.

Event inputs can be used only for models with connectors.

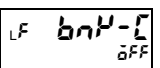
The relationship between event input (BANK1, BANK2, and BANK4) ON/OFF status and the bank number is shown below.

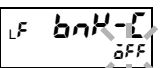
Bank No.	External terminals		
	BANK1	BANK2	BANK4
0	OFF	OFF	OFF
1	ON	OFF	OFF
2	OFF	ON	OFF
3	ON	ON	OFF
4	OFF	OFF	ON
5	ON	OFF	ON
6	OFF	ON	ON
7	ON	ON	ON

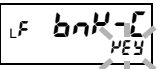
Parameter Setting Procedure

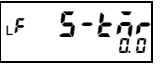
- | | | |
|-------------------------------------------------------------------------------------------------------------------------------------------------------------------------------------------------------------------------------------------------------------------------------------------------------------------------------------------------------------------------------------------------------------------------------------------------------------------------------------------------------------------------------------------------------------|-------------------------------------------------------------------------------------------------------------------------------------------------------------------------------|--------------------------------------------------------------------------------------------------------|
| <p>A Press the  [LEVEL] Key for at least 3 s in RUN level to move to the initial setting level.</p> <ul style="list-style-type: none"> • “L0” is displayed on the level/bank display to indicate the initial setting level. | 
3 s min. | 
Displays “L0.” |
| <p>B Press the  [MODE] Key several times to change the PV display to “R000.”</p> <ul style="list-style-type: none"> • This parameter is not displayed for the initial status due to setting level protect. Refer to "Limiting Key Operations" (P.5-102) for information on removing setting level protect. |  ... |  |
| <p>C Press the  [SHIFT] Key to make the SV display flash.</p> <ul style="list-style-type: none"> • The setting can be changed when the SV display starts to flash. |  |  |
| <p>D Use the  [UP] and  [SHIFT] Keys to set the password “-0159.” Press the  [MODE] Key to move to the advanced function setting level.</p> <ul style="list-style-type: none"> • “LF” is displayed on the level/bank display to indicate the advanced function setting level. | 
 | 
Displays “LF.” |
| <p>E Press the  [MODE] Key several times to change the PV display to “bnK-L.”</p> |  ... |  |
| <p>F Press the  [SHIFT] Key to make the SV display flash.</p> <ul style="list-style-type: none"> • The setting can be changed when the SV display starts to flash. |  |  |
| <p>G Use the  [UP] Key to change the set value.</p> |  |  |
| <p>H Press the  [MODE] Key to switch to the next parameter.</p> <ul style="list-style-type: none"> • The set value is registered. |  |  |

One Point

I Press the  [LEVEL] Key for at least 1 s to return to RUN level.



1 s min.

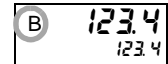

“B” is lit to indicate that the bank is enabled.

■ 2. Setting the Comparative Set Values for Each Bank

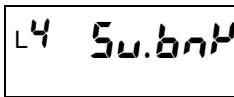

(SV.BNK)

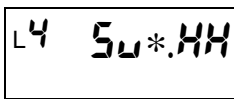

(SV*.HH)

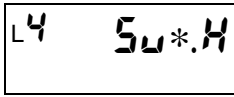

(SV*.H)

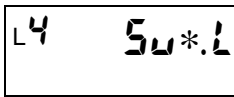

(SV*.L)

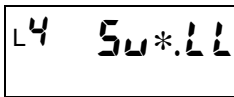

(SV*.LL)

* 0 to 7

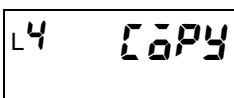

(COPY)

Once the bank selection method has been specified, set the comparative set values for each bank.

Comparative set values are set using the following parameters.

Parameter	Set value	Meaning of set value
Comparative set value *HH Su*.HH	-9999 to 9999	-19999 to 99999
Comparative set value *H Su*.H	-9999 to 9999	-19999 to 99999
Comparative set value *L Su*.L	-9999 to 9999	-19999 to 99999
Comparative set value *LL Su*.LL	-9999 to 9999	-19999 to 99999

* 0 to 7

The decimal point depends on the “decimal point position” parameter setting.

Parameter Setting Procedure

A Press the  [LEVEL] Key for at least 3 s in RUN level to move to the initial setting level.



3 s min.

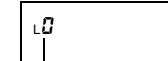

Displays “L0.”

- “L0” is displayed on the level/bank display to indicate the initial setting level.

B Press the  [LEVEL] Key several times to move to the comparative set value level.

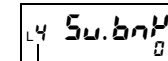

Displays “L4.”

- “L4” is displayed on the level/bank display to indicate the comparative set value level.

C Press the  [SHIFT] Key to make the SV display flash.

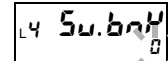

- The setting can be changed when the SV display starts to flash.

D Use the  [UP] Key to select the bank to be set.

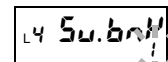

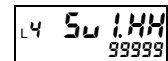

E Press the  [MODE] Key.



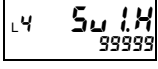

- The bank selected in step D can be set.



F Press the  [MODE] Key several times to select the comparative set value to be changed.

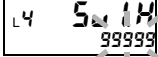





G Press the  [SHIFT] Key to make the SV display flash.

H Use the  [UP] and  [SHIFT] Keys to change the set value.







I Press the  [MODE] Key to switch to the next parameter.

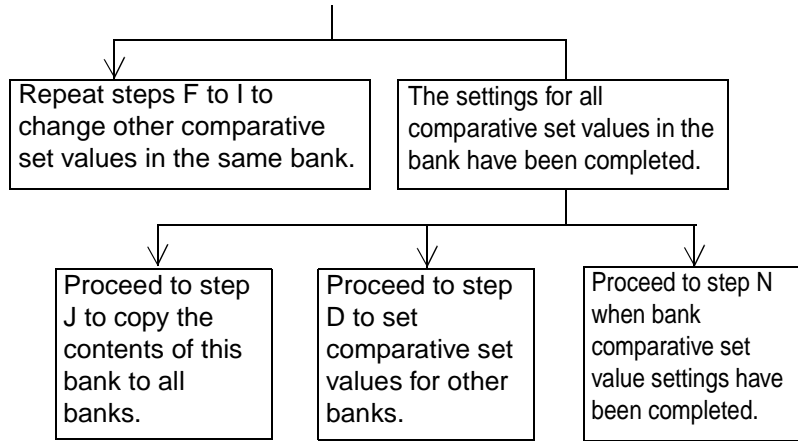



- The parameter changed in step H is registered.





J Press the  [MODE] Key several times to change the PV display to "COPY."



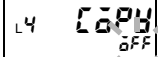

K Press the  [SHIFT] Key to make the SV display flash.



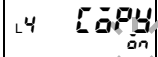

L Use the  [UP] Key to change the set value.

M Press the  [MODE] Key to switch to the next parameter "Su.bank."

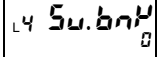

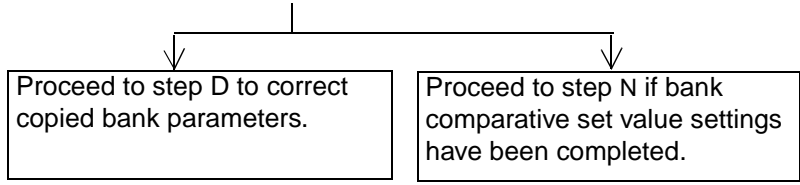



N Press the [LEVEL] Key for at least 1 s to return to RUN level.

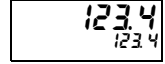

1 s min.



Copying bank comparative set values → P.5-98

5.39 Copying Bank Comparative Set Values

X V S H

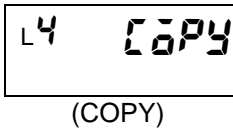

The bank copy function is used to specify a bank between 0 and 7 and copy the group of comparative set values in that bank to all banks.

Parameter Setting Procedure

- | | | |
|---------------------------------------------------------------------------------------------------------------------------------------------------------------------------------------------------------------------------------------------------|-----------------|-----------------------|
| <p>A Press the [LEVEL] Key for at least 3 s in RUN level to move to the initial setting level.</p> <ul style="list-style-type: none"> • "L0" is displayed on the level/bank display to indicate the initial setting level. | <p>3 s min.</p> | <p>Displays "L0."</p> |
| <p>B Press the [LEVEL] Key several times to move to the comparative set value level.</p> <ul style="list-style-type: none"> • "L4" is displayed on the level/bank display to indicate the comparative set value level. | | <p>Displays "L4."</p> |
| <p>C Press the [SHIFT] Key to make the SV display flash.</p> <ul style="list-style-type: none"> • The setting can be changed when the SV display starts to flash. | | |
| <p>D Use the [UP] Key to select the bank to be copied from.</p> | | |
| <p>E Press the [MODE] Key to switch to the next parameter.</p> <ul style="list-style-type: none"> • Change the comparative set values HH, H, L, and LL as required. | | |
| <p>F Press the [MODE] Key several times to change the PV display to "COPY."</p> | | |
| <p>G Press the [SHIFT] Key to make the SV display flash.</p> <ul style="list-style-type: none"> • The setting can be changed when the SV display starts to flash. | | |
| <p>H Use the [UP] Key to change the SV display to "on."</p> | | |

I Press the  [MODE] Key to switch to the next parameter.



L4 SubM
0

- The comparative set value from the copy source bank selected in step D will be copied to all banks.

5.40 Initializing All Settings

Advanced function setting level

X V S H

Important *

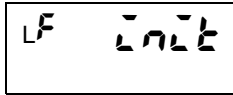

(INIT)

Initialization can be used to start settings over again from the default settings. Refer to "Parameter List" (P.A-12) for information on default set values.

Parameter Setting Procedure

A Press the [LEVEL] Key for at least 3 s in RUN level to move to the initial setting level.



3 s min.



Displays "L0."

- "L0" is displayed on the level/bank display to indicate the initial setting level.

B Press the [MODE] Key several times to change the PV display to "R000."

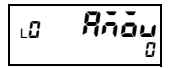

- This parameter is not displayed for the initial status due to setting level protect. Refer to "Limiting Key Operations" (P.5-102) for information on removing setting level protect.

C Press the [SHIFT] Key to make the SV display flash.



- The setting can be changed when the SV display starts to flash.

D Use the [UP] and [SHIFT] Keys to set the password "0000." Press the [MODE] Key to move to the advanced function setting level.

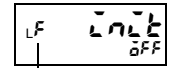
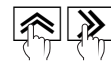

Displays "LF."

- "LF" is displayed on the level/bank display to indicate the advanced function setting level.

E Press the [SHIFT] Key to make the SV display flash.



- The setting can be changed when the SV display starts to flash.

F Use the [UP] Key to change the SV display to "00."

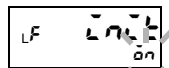

* If this operation is performed, all parameters return to the initial settings and current settings are lost. It is recommended that before performing this operation, the Parameter List at the end of this manual or some other method is used to record the current set values.

G Press the  [MODE] Key to switch to the next parameter and execute initialization.

- The set value is registered.

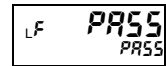

H Press the  [LEVEL] Key for at least 1 s to return to the initial setting level.



1 s min.

I Press the  [LEVEL] Key for at least 1 s to return to RUN level.

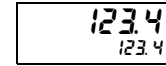

1 s min.

5.41 Limiting Key Operations

Protect level

X V S H

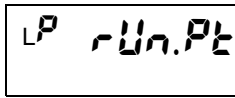

(RUN.PT)

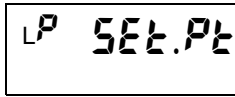

(SET.PT)

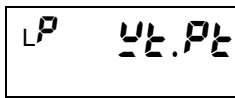

(WT.PT)

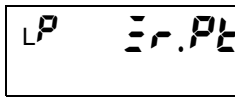

(ZR.PT)



(MM.PT)

The key protect function limits level and parameter changes using key operations. There are five kinds of key protection. The parameters, settings and details on the limitations of each kind of protection are outlined below.

○: Enabled, ×: Prohibited

● **RUN/Adjustment Protect**

The following parameter limits key operations in RUN level and movement to adjustment level.

Parameter	Set value	Restriction details		
		RUN level		Move to the adjustment level
		Present value display	Comparative set value change	
RUN/adjustment protect rUn.Pt	0	○	○	○
	1	○	○	×
	2	○	×	×

● **Setting Level Protect**

The following parameter limits moving to other levels.

Parameter	Set value	Restriction details	
		Move to the initial setting level	Move to the advanced function setting level
Setting level protect SEt.Pt	0	○	○
	1	○	×
	2	×	×

● **Setting Change Protect**

The following parameter disables changing settings with key operations.

Parameter	Set value	Restriction details
Setting change protect Wt.Pt	0FF	Setting change using key operations: Enabled
	0n	Setting change using key operations: Prohibited

* All protect level parameters and movement to advanced function setting level and calibration level can be changed.

● Forced-zero Protect

The following parameter limits key-operated execution and clearing of forced-zero and tare zero.

Parameter	Set value	Restriction details
Zero protect 三.Pt	OFF	Forced-zero using key operations and tare zero execution/clear: Enabled
	ON	Forced-zero using key operations and tare zero execution/clear: Prohibited



* Not available in the K3HB-H.

● Max./Min. Protect

The following parameter limits key operations for switching and resetting maximum and minimum values.

Parameter	Set value	Max./min. value switching	Reset
Max./Min protect 高低Pt	0	Enabled	Enabled
	1	Enabled	Prohibited
	2	Prohibited	Prohibited

Parameter Setting Procedure

A Press the  [LEVEL] and  [MODE] Keys together for at least 3 s in RUN level to move to the protect level.

- “LP” is displayed on the level/bank display to indicate protect level.

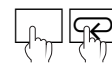

3 s min.

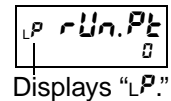

Displays “LP”

B Press the  [MODE] Key several times to display the desired protection.

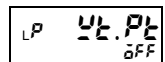
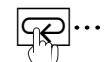

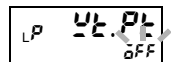

* The display shows setting change protect as an example.

C Press the  [SHIFT] Key to make the SV display flash.



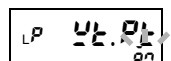

D Use the  [UP] Key to change the SV display.

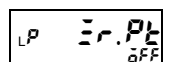

E Press the  [MODE] Key to switch to the next parameter.



- The set value is registered.

F Press the  [LEVEL] and  [MODE] Keys together for at least 1 s to return to RUN level.

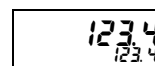
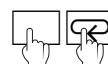

1 s min.

Section 6 *User Calibration*

6.1 About User Calibration.....	6-2
6.2 User Calibration Operation	6-5

6.1 About User Calibration

X V S H

The K3HB is calibrated correctly at shipment, so there is normally no need for the user to calibrate it. The K3HB does have a function to calibrate analog inputs that can be used when required.

Each time data is calibrated, earlier calibration data is overwritten. Be careful, therefore, because default data is lost when the K3HB is calibrated by the user.

Prepare measuring instruments and equipment for calibration separately. Refer to each manual for the instruments and equipment for information on handling the instruments and equipment.

Calibration Flowchart (for the K3HB-X/V)

User calibration is performed according to the following flowchart.

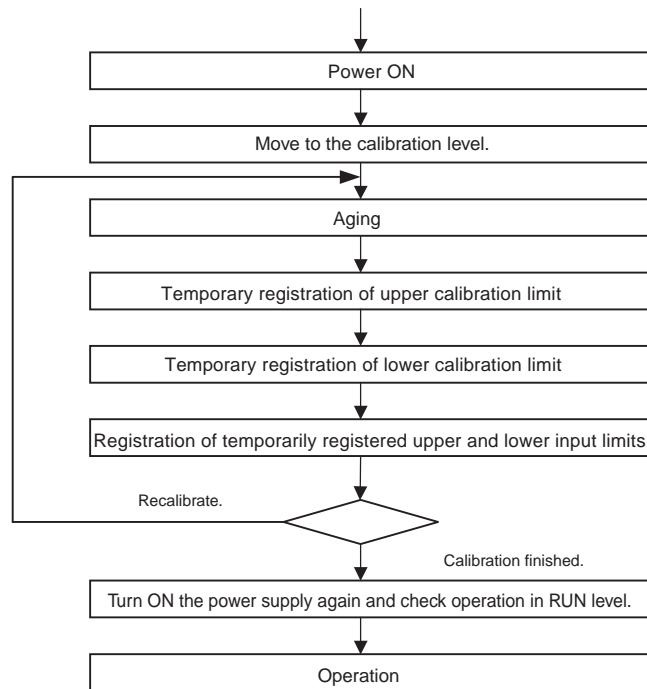

The input type that can be calibrated according to this flowchart is the type selected under the "input type A" parameter. To calibrate other input types, switch the setting for input type A in the initial setting level to the desired input type and then perform calibration according to the flowchart outlined above.

Calibration Flowchart (K3HB-S)

User calibration is performed according to the following flowchart.

User calibration is performed for input A if “A” is included in the calculation and input B if “B” is included in the calculation. Calibration is performed on both inputs A and B if both “A” and “B” are included in the calculation.

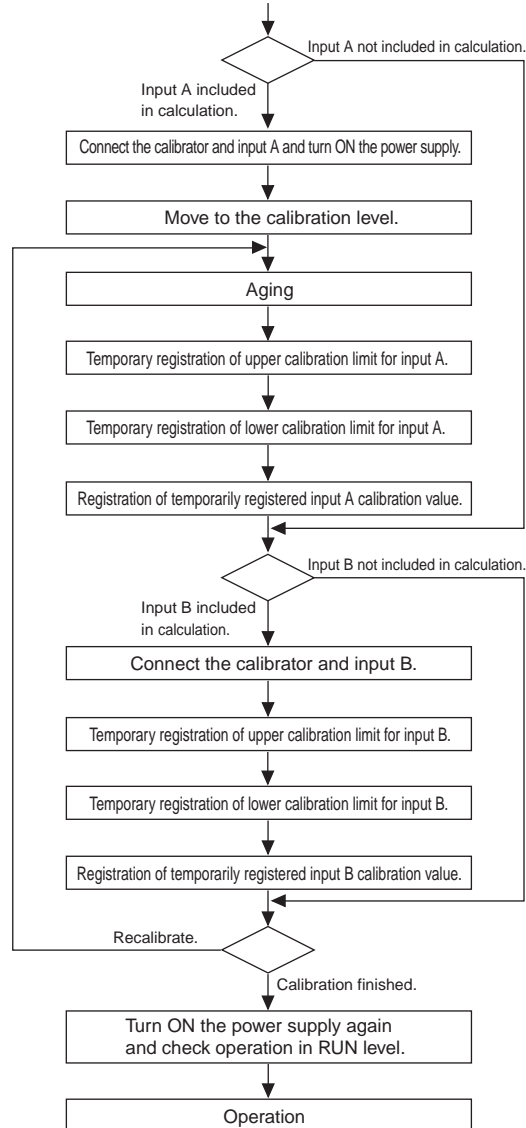

The input type that can be calibrated according to this flowchart is the type selected under “input type A” or “input type B.” To calibrate other input types, switch the setting for “input type A” or “input type B” in the initial setting level to the desired input type and then perform calibration according to the flowchart outlined above.

Calibration Flowchart (K3HB-H)

User calibration is performed according to the following flowchart.

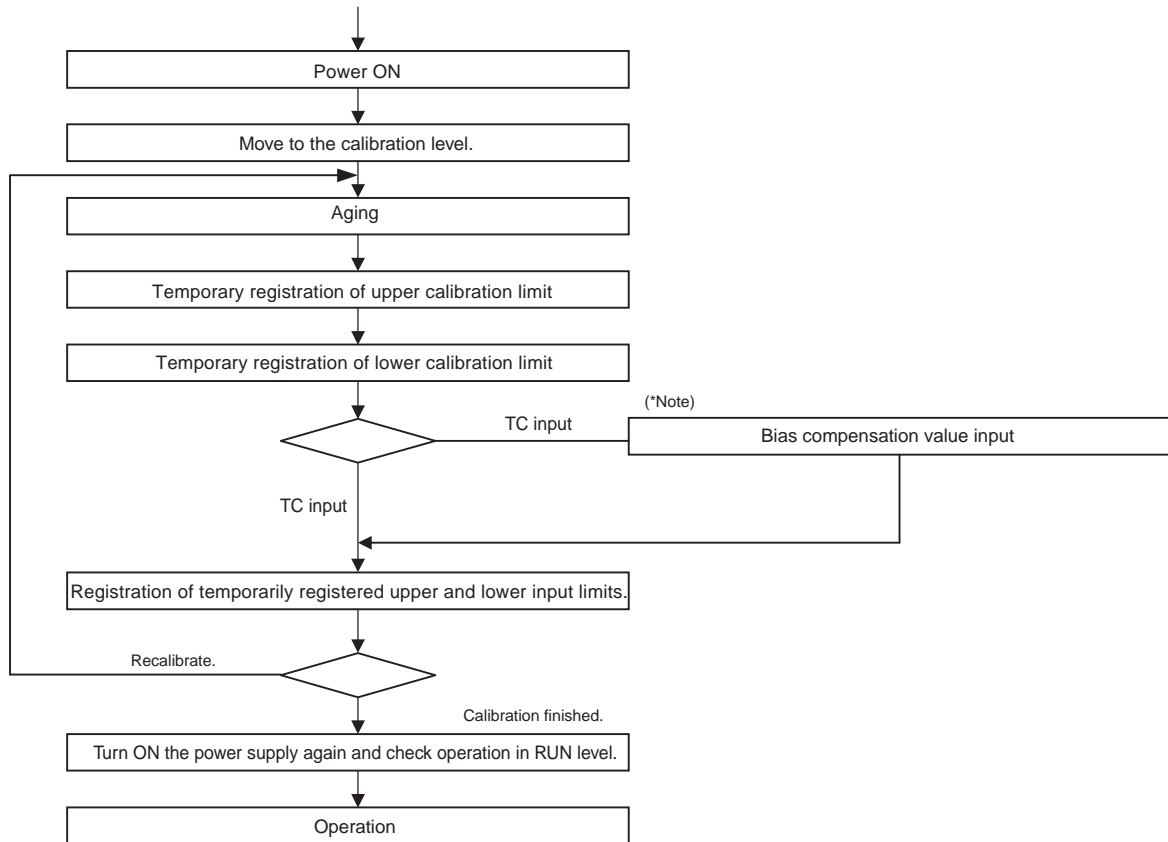

* The previous calibration value is not displayed when the status of bias compensation values is being monitored. The display cannot handle bias compensation values because they are temperature readings rather than a count. This means the value that is read during calibration is not a bias value, but the calibration value for the main input.

6.2 User Calibration Operation

X V S H

■ Connecting to the Calibrator

X V S

- Connect the Calibrator (standard voltage generator or standard current generator) to the input terminal for the input type to be calibrated.
- Use a Calibrator with enough precision for the accuracy of the K3HB.
- Do not cover the bottom during calibration. Never touch the input terminals or compensating conductor.

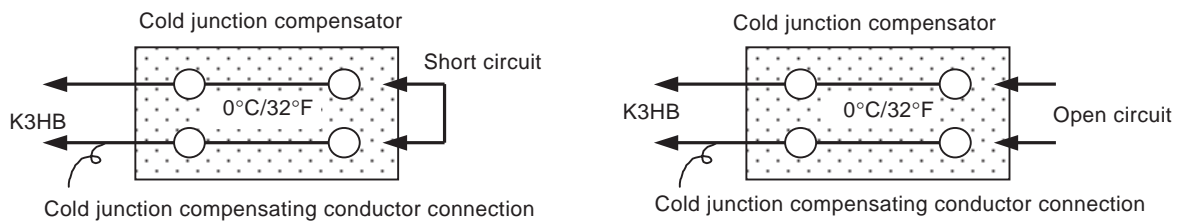

H

- Connecting the Cold Junction Compensator: The input will not be correct if the connection terminal of the cold junction compensating conductor is touched while the thermocouple is being calibrated. Short (enable) or open (disable) the tip of the thermocouple in the cold junction compensator with the compensating conductor connected as shown below. Use this method to connect and disconnect the cold junction compensator.
- Thermocouples are calibrated by type, i.e., Group 1 (input types 2, 4, 7, 8, 10, and 14) and Group 2 (input types 3, 5, 6, 9, 11, 12, and 13).
- Use the correct compensating conductor for the selected thermocouple. The cold junction compensator and compensating conductor for thermocouple K are used for thermocouples R, S, E, B, and W.
- Set the thermocouple to be calibrated in the cold junction compensator and setting it to 0°C. Disable the internal thermocouple (open the tip).
- Use a calibrator that is sufficiently precise for the accuracy of the K3BH.
- Do not cover the bottom during calibration. Never touch the input terminals or compensating conductor.

■ Key Operation Procedure

Perform the operation according to the following procedure.

Moving to Calibration Level

Parameter Setting Procedure

A Move to the advanced function setting level, press the [MODE] Key several times and display the “ $\overline{L} \overline{A} \overline{D} \overline{J}$ ” parameter to move to the calibration level.

- The parameter character is “ $\overline{L} \overline{A} \overline{D} \overline{J}$.”

B Press the [SHIFT] Key to make the SV display flash.

- The parameter can be changed when the SV display starts to flash.

C Use the [UP] and [SHIFT] Keys to set the password. The password is “1201” (1201).

D Press the [MODE] Key to write the password.

- If the password is correct, the Unit moves to the calibration level.
- If the password is incorrect, the Unit remains in the advanced function setting level and the next parameter is displayed.

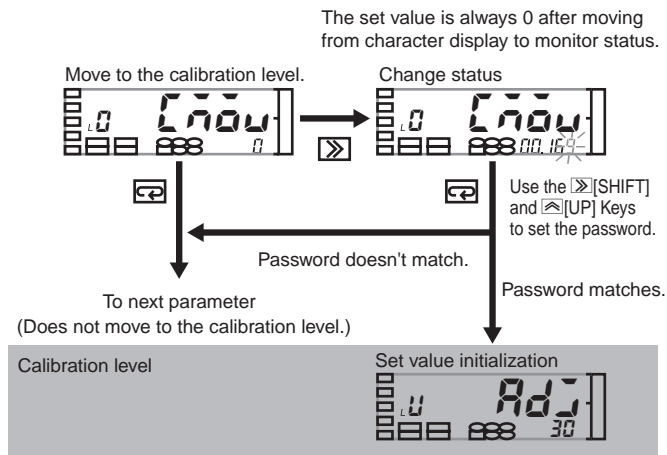

Operation in Calibration Level

Parameter Operation Procedure

A Follow the steps outlined above to move to the calibration level.

- The aging timer is displayed.
- The aging timer is a 30-minute countdown timer that counts until 0 is reached.
- A calibration record mark will be displayed if a user calibration history exists.

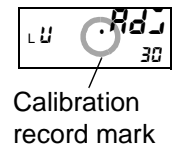
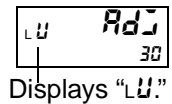

B Perform aging until the aging timer reaches 0. (If the calibrator needs more than 30 minutes of aging, extend the aging until the conditions are met.)

- If the [MODE] Key is pressed while the aging timer is counting down, the display skips to the calibration upper limit parameter display.

C Press the [MODE] Key to display the parameter for the calibration upper limit.



- The parameter for the present input type is displayed. Refer to the table on P.6-9 for details on the relationship between parameters and the input type.
- The display will be as shown if “A” is not included in the calculation, and the calibration then will be for input “B” (K3HB-S only).

D The calibrator applies a reference signal that corresponds to the calibration upper limit.

- Refer to the table on P.6-9 for required reference signal values.

E Press the [UP] Key.



- The reference signal is read and “T” starts flashing.

“T” is flashing.

F Press the [UP] Key again to temporarily register the calibration upper limit.



“T” is lit.

G Repeat steps D to F to temporarily register the calibration lower limit.

- When temporary registration has been completed, the parameter for registration “5tr” is displayed.
- Perform step L for the K3HB-H (TC input).

H Press the [SHIFT] Key to make the SV display flash.



- The setting can be changed when the SV display starts to flash.

I Use the  [UP] Key to change the set value to "4E5."

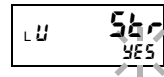

J Press the  [MODE] Key.

- The calibration value is "registered."
- When there are two inputs, input B is calibrated next. Connect the reference device to input B and repeat steps D to J (K3HB-S only).

K Turn ON the power again and check the operation.

K3HB-H (TC Input)

Perform step F and then perform bias compensation.

L Press the  [MODE] Key to change to bias calibration.

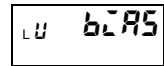

- Disconnect the standard voltage generator or standard current generator.
- Turn ON the thermocouple of the cold junction compensator. Make sure the cables for the standard voltage generator or standard current generator are disconnected at this time.
- Calibration values are not displayed when bias compensation values are being monitored. (The value that is read is not a bias value. Instead, the display shows calibration values for the main inputs.)

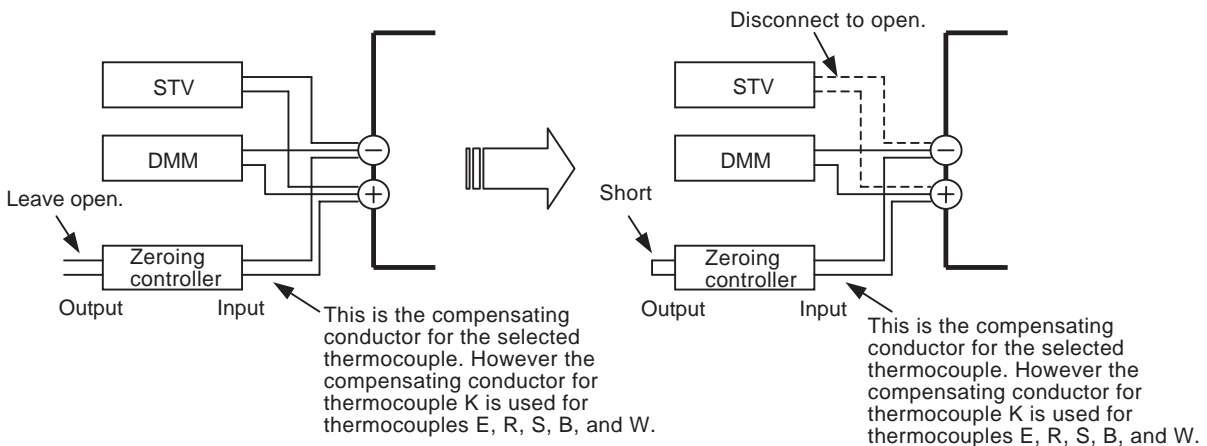

M After the count stabilizes, press the  [UP] Key.

- The current value is displayed.

N Press the  [UP] Key again.

- The count value is set.

● **Input Type and Parameter/Reference Signal**

K3HB-X

Input	Input type	Calibration upper limit		Calibration lower limit	
		Parameters	Reference signal	Parameters	Reference signal
XVD	-199.99 to 199.99 V	<i>199.99</i>	199.99 V	- <i>199.99</i>	-199.99 V
	-19.999 to 19.999 V	<i>19.999</i>	19.999 V	- <i>19.999</i>	-19.999 V
	-1.9999 to 1.9999 V	<i>1.9999</i>	1.9999 V	- <i>1.9999</i>	-1.9999 V
	1.0000 to 5.0000 V	<i>5.0000</i>	5.0000 V	<i>1.0000</i>	1.0000 V
XAD	-199.99 to 199.99 mA	<i>199.99</i>	199.99 mA	- <i>199.99</i>	-199.99 mA
	-19.999 to 19.999 mA	<i>19.999</i>	19.999 mA	- <i>19.999</i>	-19.999 mA
	-1.9999 to 1.9999 mA	<i>1.9999</i>	1.9999 mA	- <i>1.9999</i>	-1.9999 mA
	4.000 to 20.000 mA	<i>2.0000</i>	20.000 mA	<i>4.000</i>	4.000 mA
XVA	0.0 to 400.0 V	<i>400.0</i>	400.0 V	<i>0.0</i>	0.0 V
	0.00 to 199.99 V	<i>199.99</i>	199.99 V	<i>0.00</i>	0.00 V
	0.000 to 19.999 V	<i>19.999</i>	19.999 V	<i>0.000</i>	0.000 V
	0.0000 to 1.9999 V	<i>1.9999</i>	1.9999 V	<i>0.0000</i>	0.0000 V
XAA	0.000 to 10.000 A	<i>10.000</i>	10.000 A	<i>0.000</i>	0.000 A
	0.0000 to 1.9999 A	<i>1.9999</i>	1.9999 A	<i>0.0000</i>	0.0000 A
	0.00 to 199.99 mA	<i>199.99</i>	199.99 mA	<i>0.00</i>	0.00 mA
	0.000 to 19.999 mA	<i>19.999</i>	19.999 mA	<i>0.000</i>	0.000 mA

K3HB-V

Input type	Calibration upper limit		Calibration lower limit	
	Parameters	Reference signal	Parameters	Reference signal
0.00 to 199.99 mV	<i>199.99</i>	199.99 mV	<i>0.00</i>	0.00 mV
0.000 to 19.999 mV	<i>19.999</i>	19.999 mV	<i>0.000</i>	0.000 mV
±100.00 mV	<i>100.00</i>	100.00 mV	<i>- 100.00</i>	-100.00 mV
±199.99 mV	<i>199.99</i>	199.99 mV	<i>- 199.99</i>	-199.99 mV

K3HB-S

Input	Input type	Calibration upper limit		Calibration lower limit	
		Parameters	Reference signal	Parameters	Reference signal
A	0 to 20 mA, 4 to 20 mA	<i>A 20</i>	20.00 mA	<i>A 4</i>	4.00 mA
	0 to 5 V, 1 to 5 V	<i>A 5</i>	5.000 V	<i>A 1</i>	1.000 V
	±5 V	<i>A 5</i>	5.000 V	<i>A -5</i>	-5.000 V
	±10 V	<i>A 10</i>	10.000 V	<i>A -10</i>	-10.000 V
B	0 to 20 mA, 4 to 20 mA	<i>b 20</i>	20.00 mA	<i>b 4</i>	4.00 mA
	0 to 5 V, 1 to 5 V	<i>b 5</i>	5.000 V	<i>b 1</i>	1.000 V
	±5 V	<i>b 5</i>	5.000 V	<i>b -5</i>	-5.000 V
	±10 V	<i>b 10</i>	10.000 V	<i>b -10</i>	-10.000 V

K3HB-H

Input type		Calibration upper limit		Calibration lower limit	
		Parameters	Reference signal	Parameters	Reference signal
PT	PT100 (0)	<i>P 390</i>	390 Ω	<i>P 20</i>	20 Ω
	PT100 (1)	<i>P 160</i>	160 Ω	<i>P 40</i>	40 Ω
TC	K (2), J (4), E (7), L (8), N (10), W (14)	<i>t 53</i>	53 mV	<i>t -6</i>	-6 mV
	K (3), J (5), T (6), U (9), R (11), S (12), B (13)	<i>t 22</i>	22 mV	<i>t -6</i>	-6 mV

Section 7 Troubleshooting

7.1 Error Displays	7-2
7.2 Countermeasures	7-3

7.1 Error Displays

PV display	SV display	Description of error	Countermeasure
Unit	Err	An unexpected Unit was detected.	The mounting position depends on the Unit model. Check the Unit's model number and mount it in the correct position.
Unit	LE	Displayed the first time power is turned ON after mounting a new Unit.	Press the <input type="checkbox"/> [LEVEL] Key for at least 3 s to register the new Unit configuration.
dSP	Err	Display error	Repair is necessary. Consult your OMRON representative.
SYS	Err	Internal memory error	Repair is necessary. Consult your OMRON representative.
EEP	Err	Error in non-volatile memory	Press the <input type="checkbox"/> [LEVEL] Key in this state for at least 3 s to return to the factory settings. If the problem still persists, repair is necessary. Contact the point of purchase or your OMRON representative.
Flashing on 5Err (RErr *2) (bErr *2)	Normal operation	The input value is outside the possible measurement range or the input is faulty. This problem may occur if the power is turned ON with nothing connected to the input terminal. This only means that the input is outside the possible measurement range and does not indicate a product failure.	Change the input type setting to an appropriate value in the initial setting level. Quickly return the input to within the possible measurement range. Refer to "5.2 Setting Input Types" for details on the possible measurement range for each input type. → P.5-11 If the problem still persists after implementing the preceding measures, repair is necessary. Contact the point of purchase or your OMRON representative.
Flashing on 99999 or -99999	Normal operation	The measurement value after scaling is either greater than 99,999 or less than -19,999.	Operation will continue with a measurement value of 99,999 or -19,999. If there is an operating problem, adjust the input range and scaling value until the measurement value falls within the range. Place the switch below the E slot toward the front (K3HB-H only). The scaling value may be inappropriate. Review the scaling value in the initial setting level.

*1. The parameters already set are returned to the factory settings.

If the problem still persists after performing initialization, repair is necessary.

*2. K3HB-S only. When an error occurs for input A or inputs A and B, the display will show "**RErr**." When an error occurs for input B only, the display will show "**bErr**."

7.2 Countermeasures

Symptoms	Inspection details	Countermeasure
Forced-zero is not executed when the  [UP] Key is pressed.	Is forced-zero protect enabled?	Set the forced-zero protect to OFF (Enable) in the protect level.
The display remains on “-----” after the power is turned ON.	Is the “startup compensation timer” setting too long?	The “startup compensation timer” can be set up to 99.9 s. Change the setting to an appropriate value.
	Is the HOLD input still ON?	Turn OFF the HOLD input. If the HOLD input remains ON and the power is turned ON, the display remains on “-----” while the HOLD input remains ON.
	Is the RESET input still ON?	Turn OFF the RESET input.
The comparative output does not turn OFF even if the measurement value returns to the normal range.	Is the hysteresis setting too large?	Change the setting to an appropriate value.
	Is the “output refresh stop” set?	Turn OFF the “output refresh stop.”
Cannot move to the advanced functions.	Is the operation protected?	Refer to Advanced Function Setting Level for information on how to clear protection. → P.5-5

Appendices

Specifications.....	A-2
Model Number Structure.....	A-9
Parameter List.....	A-12
Parameter Display Conditions	A-17
About Parameters	A-18
Sampling and Comparative Output Response Times.....	A-26
No Measurement Status	A-30

Specifications

■ Ratings

Power supply voltage		100 to 240 VAC (50/60 Hz) 24 VAC (50/60 Hz)/VDC		
Allowable power supply voltage range		85% to 110% of the rated power supply voltage		
Power consumption		100 to 240 VAC: 18 VA max., 24 VAC/VDC: 11 VA/7W max.		
Absolute max. ratings of inputs	K3HB-S	0 to 5 V	±10 V	
		1 to 5 V	±10 V	
		±5 V	±10 V	
		±10 V	±14.5 V	
		0 to 20 mA	31 mA	
		4 to 20 mA	31 mA	
	K3HB-XVD	±199.99 V	±400-V allowable instantaneous overload (30 s)	
		±19.999 V	±200-V allowable instantaneous overload (30 s)	
		±1.9999 V	±200-V allowable instantaneous overload (30 s)	
		1.0000 to 5.0000 V	±200-V allowable instantaneous overload (30 s)	
	K3HB-XAD	±199.99 mA	±400-V allowable instantaneous overload (30 s)	
		±19.999 mA	±200-V allowable instantaneous overload (30 s)	
		±1.9999 mA	±200-V allowable instantaneous overload (30 s)	
		4.000 to 20.000 mA	±200-V allowable instantaneous overload (30 s)	
	K3HB-XVA	0.0 to 400.0 V	700-V allowable instantaneous overload (30 s)	
		0.00 to 199.99 V	700-V allowable instantaneous overload (30 s)	
		0.000 to 19.999 V	400-V allowable instantaneous overload (30 s)	
		0.0000 to 1.9999 V	400-V allowable instantaneous overload (30 s)	
	K3HB-XAA	0.000 to 10.000 A	20-A allowable instantaneous overload (30 s)	
		0.0000 to 1.9999 A	20-A allowable instantaneous overload (30 s)	
		0.00 to 199.99 mA	2-A allowable instantaneous overload (30 s)	
		0.000 to 19.999 mA	2-A allowable instantaneous overload (30 s)	
	K3HB-V	0.00 to 199.99 mV	±200-V allowable instantaneous overload (30 s)	
		0.000 to 19.999 mV	±200-V allowable instantaneous overload (30 s)	
±100.00 mV		±200-V allowable instantaneous overload (30 s)		
±199.99 mV		±200-V allowable instantaneous overload (30 s)		
External power supply		12 VDC ± 10% 80 mA (only for models with external power supply)		
		10 VDC ± 10% 100 mA (only for models with external power supply)		
Input range (measurement range)	K3HB-S	DC voltage/current (0 to 20 mA, 4 to 20 mA, 0 to 5 V, 1 to 5 V, ±5 V, ±10 V) 2 channels		
	K3HB-X (Measurement type: CAT II)	DC voltage: ±199.99 V, ±19.999 V, ±1.999 V, 1.000 to 5.000 V DC current: ±199.99 mA, ±19.999 mA, ±1.999 mA, 4.000 to 20.000 mA AC voltage: 0.0 to 400.0 V, 0.00 to 199.99 V, 0.000 to 19.999 V, 0.0000 to 1.9999 V AC current: 0.000 to 10.000 A, 0.0000 to 1.999 A, 0.00 to 199.99 mA, 0.000 to 19.999 mA		
	K3HB-V	Load cell (0.00 to 199.99 mV, 0.000 to 19.999 mV, ±100.00 mV, ±199.99 mV)		

Input impedance	K3HB-S	Current range: 120 Ω max., Voltage range: 1 M Ω min.
	K3HB-X	DC voltage for ± 199.9 V: 10 M Ω min., For other ranges: 1 M Ω min. DC current for ± 199.99 mA: 1 Ω max., For ± 19.999 mA or 4 to 20 mA: 10 Ω max., For ± 1.9999 mA: 33 Ω max. AC voltage: 1 M Ω min., AC current for 0 to 10 A or 0 to 1.9999 A: 0.5 VACT, For 0 to 199.99 mA: 1 Ω max., For 0 to 19.999 mA: 10 Ω max.
	K3HB-V	Load cell: 1 M Ω min.
Event inputs	Timing input	NPN open collector or no-voltage contact signal ON residual voltage: 3 V max. ON current at 0 Ω : 17 mA max. Max. applied voltage: 30 VDC max. OFF leakage current: 1.5 mA max.
	Startup compensation timer input	NPN open collector or no-voltage contact signal ON residual voltage: 2 V max. ON current at 0 Ω : 4 mA max.
	Hold input	Max. applied voltage: 30 VDC max.
	Reset input	OFF leakage current: 0.1 mA max.
	Forced-zero input	
	Bank input	
A/D conversion method	K3HB-S	Sequential comparison system
	K3HB-H/X/V	Digital sigma system
Output ratings	Relay output	250 VAC, 30 VDC, 5 A (resistive load) Mechanical life expectancy: 5,000,000 operations, Electrical life expectancy: 100,000 operations
	Transistor output	Maximum load voltage: 24 VDC, Maximum load current: 50 mA, Leakage current: 100 μ A max.
	Linear output	0 to 20 mA DC, 4 to 20 mA: Load: 500 Ω max, Resolution: Approx. 10,000, Output error: $\pm 0.5\%$ FS 0 to 5 VDC, 1 to 5 VDC, 0 to 10 VDC: Load: 5 k Ω min, Resolution: Approx. 10,000, Output error: $\pm 0.5\%$ FS (but ± 0.15 V, 0V for 1 V or less)
Display method	<ul style="list-style-type: none"> Negative LCD (backlit LCD) display 7-segment digital display (Character height: PV: 14.2 mm (green/red); SV: 4.9 mm (green)) 	
Ambient operating temperature	-10 to 55°C (with no icing or condensation)	
Ambient operating humidity	25% to 85%	
Storage temperature	-25 to 65°C (with no icing or condensation)	
Altitude	2,000 m max.	
Accessories	2 fixtures, unit stickers, operation manual, waterproof packing, terminal cover, DeviceNet connector*, crimp terminals (Hirose HR31-SC-121)*	

* DeviceNet only

■ Characteristics

Sampling period	K3HB-S		One input: 0.5 ms; Two inputs: 1 ms	
	K3HB-X/V/H		20 ms	
Display range	-19999 to 99999			
Comparative output response time	K3HB-S	Linear output response time	50 ms after comparative output	
		Comparative output response time	One input: OFF → ON 1 ms, ON → OFF 1.5 ms Two inputs: OFF → ON 2 ms, ON → OFF 2.5 ms	
	K3HB-V	Linear output response time	DC input	150 ms
		Comparative output response time	DC input	100 ms
	K3HB-X	Linear output response time	DC input	150 ms
			AC input	420 ms
		Comparative output response time	DC input	100 ms
			AC input	300 ms
	K3HB-H	Linear output response time	PT input	170 ms
			TC input	230 ms
		Comparative output response time	PT input	120 ms
			TC input	180 ms
Insulation resistance	20 MΩ min. (at 500 VDC)			
Dielectric strength	Between external terminals and case 2,300 VAC for 1 min between external terminals and case			
Noise immunity	100 to 240-VAC models: ±1,500 V at power supply terminals in normal or common mode (waveform with 1-ns rising edge and pulse width of 1 μs/100 ns) 24-VAC/VDC models: ±1,500 V at power supply terminals in normal or common mode (waveform with 1-ns rising edge and pulse width of 1 μs/100 ns)			
Vibration resistance	Frequency: 10 to 55 Hz; Acceleration: 50 m/s ² to 10 sweeps of 5 min each in X, Y, and Z directions			
Shock resistance	150m/s ² (100m/s ² for relay outputs) 3 times each in 3 axes, 6 directions			
Weight	Approx. 300 g (Digital Indicator only)			
Degree of protection	Front panel: Conforms to NEMA 4X (equivalent to IP66), Rear case: IP20, Terminals: IP00 + finger protection (VDE 0106/100)			
Memory protection	EEPROM (non-volatile memory) Number of rewrites: 100,000 times			
Installation environment	Overvoltage category II, pollution degree 2 (as per IEC61010-1)			

Applicable standards	UL61010C-1, CSA C22.2 No. 1010.1 (evaluated by UL) EN61010-1 (IEC61010-1): Pollution degree 2/overvoltage category II EN61326: 1997, A1: 1998, A2: 2001 * Applies only when the product is used indoors. The K3HB-XVA□□ complies with UL standards when the applied input voltage is within the range 0 to 150 VAC.	
EMC	(EMI)	EN61326+A1 Industrial applications
	Terminal interference wave voltage	EN55011 11 Group 1, Class A: CISPR16-1/-2
	Electromagnetic interference wave	EN55011 11 Group 1, Class A: CISPR16-1/-2
	(EMS)	EN61326+A1 Industrial applications
	Electrostatic discharge (ESD)	EN61000-4-3: 4 kV (contact) : 8 kV (in air)
	Radiating radio-frequency electromagnetic field	EN61000-4-3: 10 V/m 1 kHz sine wave amplitude modulation (80 MHz to 1 GHz)
	Burst	EN61000-4-4: 2 kV (power line) : 1 kV (I/O signal line)
	Surge	EN61000-4-5: 1 kV with line (power line) : 2 kV with ground (power line)
	Radio-frequency electric interference	EN61000-4-6: 3 V (0.15 to 80 GHz)
	Momentary power interruptions from voltage dips	EN61000-4-11: 0.5 cycle, 0°, 180°, 100% (rated voltage)

Input Characteristics

K3HB-X

Input type	Setting range	Specified range	Accuracy
DC voltage VD	±199.99 V ±19.999 V ±1.9999 V 1.0000 to 5.0000 V	-199.99 to 219.99 V -1.999 to 21.999 V -1.9999 to 2.1999 V 0.5000 to 5.5000 V	DC voltage input, all ranges: ±0.1% rdg ±1 dig max. DC current input, all ranges: ±0.1% rdg ±1 dig max. AC voltage input, 0.0 to 400.0 V or 0.00 to 199.99 V: ±0.3% rdg ±5 dig max. AC voltage input, 0.000 to 19.999 V or 0.0000 to 1.9999 V: ±0.5% rdg ±10 dig max. AC current input, 0.000 to 10.000 A or 0.0000 to 1.9999 A: ±0.5% rdg ±20 dig max. AC current input, 0.00 to 199.99 mA or 0.000 to 19.999 A: ±0.5% rdg ±10 dig max.
DC current AD	±199.99 mA ±19.999 mA ±1.9999 mA 4.000 to 20.000 mA	-199.99 to 219.99 mA -19.999 to 21.999 mA -1.9999 to 2.1999 mA 2.000 to 22.000 mA	
AC voltage VA	0.0 to 400.0 V 0.00 to 199.99 V 0.000 to 19.999 V 0.0000 to 1.9999 V	0.0 to 440.0 V 0.00 to 219.99 V 0.000 to 21.999 V 0.0000 to 1.9999 V	
AC current AA	0.000 to 10.000 A 0.0000 to 1.9999 A 0.00 to 199.99 mA 0.000 to 19.999 mA	0.000 to 11.000 A 0.0000 to 2.1999 A 0.00 to 219.99 mA 0.000 to 21.999 mA	

Note: The accuracy is for an input frequency range of 40 Hz to 1 kHz (except for AD current input A and B ranges) and an ambient temperature of 23 ±5°C. The error, however, increases below 10% of the maximum input value.

DC voltage input, all ranges: 10% or less of max. input = ±0.15% FS

DC current input, all ranges: 10% or less of max. input = ±0.1% FS

AC voltage input, 0.0 to 400.0 V: 10% or less of max. input = ±0.15% FS

AC voltage input, 0.00 to 199.99 V: 10% or less of max. input = ±0.2% FS

AC voltage input, 0.000 to 19.999 V or 0.0000 to 1.9999 V: 10% or less of max. input = ±1.0% FS

AC current input, 0.000 to 10.000 A: 10% or less of max. input = ±0.25% FS

AC current input, 0.0000 to 1.9999 A: 10% or less of max. input = ±0.5% FS

AC current input, 0.00 to 199.99 mA or 0.000 to 19.999 A: 10% or less of max. input = ±0.15% FS

K3HB-V

Input type	Setting range	Specified range	Accuracy
A	0.00 to 199.99 mV	-19.99 to 219.99 mA	0.00 to 199.99 mV: ±0.1% rdg ±1 dig max. 0.000 to 19.999 mV: ±0.1% rdg ±5 dig max. ±100.00 mV: ±0.1% rdg ±3 dig max. ±199.999 mV: ±0.1% rdg ±1 dig max.
B	0.000 to 19.999 mV	-1.999 to 21.999 mA	
C	±100.00 mV	-110.00 to 110.00 mV	
D	±199.999 mV	-199.99 to 219.99 mV	

Note: The accuracy is for an ambient temperature of 23 ±5°C. For all ranges, 10% or less of max. input = ±0.1% FS.

K3HB-S

Input type	Setting range	Specified range	Accuracy
Voltage input Inputs A and B	0 to 5 V	-0.5 to 5.5 V	For 1 input: $\pm 0.1\%$ FS ± 1 digit max. (for $23\pm 5^\circ\text{C}$) For 2 inputs: $\pm 0.2\%$ FS ± 1 digit max. (for $23\pm 5^\circ\text{C}$)
	1 to 5 V	0.5 to 5.5 V	
	-5 to 5 V	-5.5 to 5.5 V	
	-10 to 10 V	-11 to 11 V	
Current input Inputs A and B	0 to 20 mA	-2 to 22 mA	
	4 to 20 mA	2 to 22 mA	

K3HB-H

Input type	Setting range		Specified range		Accuracy
	$^\circ\text{C}$	$^\circ\text{F}$	$^\circ\text{C}$	$^\circ\text{F}$	
Pt100 (1)	-200.0 to 850.0	-300.0 to 1500.0	-305.0 to 955.0	-480.0 to 1680.0	Thermocouple input: ($\pm 0.3\%$ PV or $\pm 1^\circ\text{C}$ whichever is larger) ± 1 digit max. although there may be exceptions K, T, N (-100° or less): $\pm 2^\circ\text{C} \pm 1$ digit max. U, L: $\pm 2^\circ\text{C} \pm 1$ digit max. B (400°C max.): Nothing specified. R, S (200° max.): $\pm 3^\circ\text{C} \pm 1$ digit max. W: ($\pm 0.3\%$ PV or $\pm 3^\circ\text{C}$ whichever is larger) ± 1 digit max. Platinum-resistance thermometer input: ($\pm 0.2\%$ PV or $\pm 0.8^\circ\text{C}$ whichever is larger) ± 1 digit max.
Pt100 (2)	-150.0 to 150.0	-199.99 to 300.0	-180.00 to 180.00	-199.99 to 350.00	
K (1)	-200.0 to 1300.0	-300.0 to 2300.0	-350.0 to 1450.0	-560.0 to 2560.0	
K (2)	-20.0 to 500.0	0.0 to 900.0	-72.0 to 552.0	-90.0 to 990.0	
J (1)	-100.0 to 850.0	-100.0 to 1500.0	-195.0 to 945.0	-260.0 to 1660.0	
J (2)	-20.0 to 400.0	0.0 to 750.0	-62.0 to 442.0	-75.0 to 825.0	
T	-200.0 to 400.0	-300.0 to 700.0	-260.0 to 460.0	-400.0 to 800.0	
E	0.0 to 600.0	0.0 to 1100.0	-60.0 to 660.0	-110.0 to 1210.0	
L	-100.0 to 850.0	-100.0 to 1500.0	-195.0 to 945.0	-260.0 to 1660.0	
U	-200.0 to 400.0	-300.0 to 700.0	-260.0 to 460.0	-400.0 to 800.0	
N	-200.0 to 1300.0	-300.0 to 2300.0	-350.0 to 1450.0	-560.0 to 2560.0	
R	0.0 to 1700.0	0.0 to 3000.0	-170.0 to 1870.0	-300.0 to 3300.0	
S	0.0 to 1700.0	0.0 to 3000.0	-170.0 to 1870.0	-300.0 to 3300.0	
B	100.0 to 1800.0	300.0 to 3200.0	-70.0 to 1970.0	10.0 to 3490.0	
W	0.0 to 2300.0	0.0 to 4100.0	-230.0 to 2530.0	-410.0 to 4510.0	

■ Power Supply Derating Curve for Sensor (Reference Value)

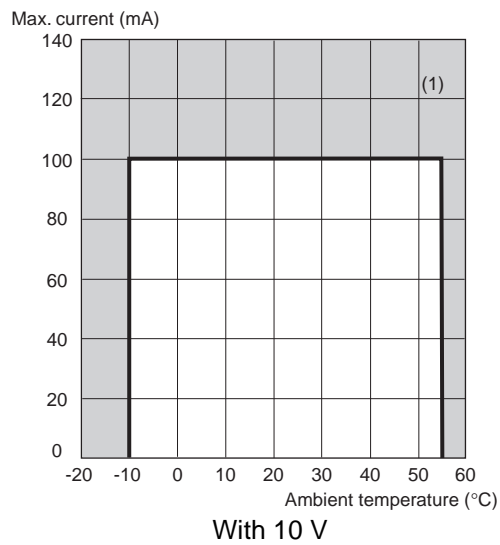
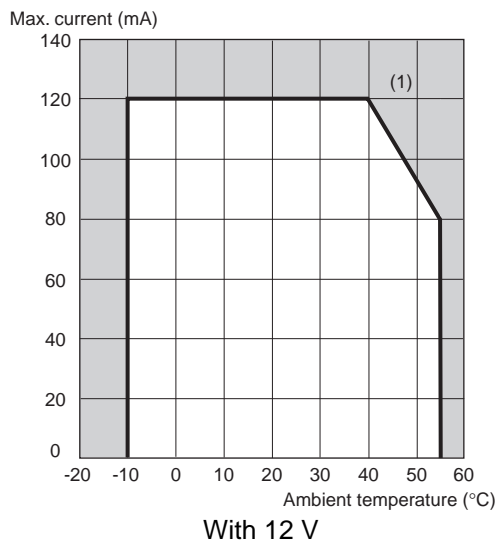

- Note 1. The above values are for standard mounting. Be careful because the derating curve differs depending on the mounting conditions.
2. Do not use the Sensor outside of the derating area (i.e., do not use it in the area labeled (1) in the above graphics). Doing so may deteriorate or damage internal components.

Model Number Structure

Base Units

K3HB- **-**
 ① ② ⑥

1. Models by Type

Code	Input specifications
X	Voltage and Current Process Indicator
V	Weighing Indicator
S	Linear Sensor Indicator
H	Temperature Indicator

2. Input Range

Code	Auxiliary output and external power supply specifications
VD	DC voltage input
AD	DC current input
VA	AC voltage input
AA	AC current input
LC	Load cell input (DC low-voltage input)
SD	Process input
TA	Temperature input

6. Power Supply Specifications

Code	Power supply voltage
100 to 240 VAC	100 to 240 VAC, 50/60 Hz
24 VAC/VDC	24 VAC/VDC, 50/60 Hz

Optional Boards

Sensor Power Supply/Output Boards

K33-
 ③

Relay/Transistor/BCD/DeviceNet/Output Boards

K34-
 ④

Event Input Boards

K35-
 ⑤

Base Units with Optional Boards

K3HB-□□-□□□ □
 ① ② ③ ④ ⑤ ⑥

1. Models by Type

Code	Input specifications
X	Voltage and Current Process Indicator
V	Weighing Indicator
S	Linear Sensor Indicator
H	Temperature Indicator

2. Input Range

Code	Auxiliary output and external power supply specifications
VD	DC voltage input
AD	DC current input
VA	AC voltage input
AA	AC current input
LC	Load cell input (DC low-voltage input)
SD	Process input
TA	Temperature input

3. Analog, Communications, and Other Output Specifications (K33)

Code	Auxiliary output and external power supply specifications
None	None
CPA	Relay output (PASS: SPDT) + Sensor power supply (12 VDC, ±10%, 80 mA)
CPB	Relay output (PASS: SPDT) + Sensor power supply (10 VDC, ±5%, 100 mA)
L1A	Linear current output (DC0(4) - 20 mA) + Sensor power supply (12 VDC, ±10%, 80 mA)
L1B	Linear current output (DC0(4) - 20 mA) + Sensor power supply (10 VDC, ±5%, 100 mA)
L2A	Linear voltage output (DC0(1) - 5 V, 0 to 10 V) + Sensor power supply (12 VDC, ±10%, 80 mA)
L2B	Linear voltage output (DC0(1) - 5 V, 0 to 10 V) + Sensor power supply (10 VDC, ±5%, 100 mA)
A	Sensor power supply, 12 VDC, ±10%, 80 mA
B	Sensor power supply, 10 VDC, ±5%, 100 mA
FLK1A	Communications (RS-232C) + Sensor power supply (12 VDC, ±10%, 80 mA)
FLK1B	Communications (RS-232C) + Sensor power supply (10 VDC, ±5%, 100 mA)
FLK3A	Communications (RS-485) + Sensor power supply (12 VDC, ±10%, 80 mA)
FLK3B	Communications (RS-485) + Sensor power supply (10 VDC, ±5%, 100 mA)

4. Relay/Transistor Output Specifications (K34)

Code	Pulse output specifications
None	None
C1	Relay contact (H/L: SPDT each)
C2	Relay contact (HH/H/LL/L: SPST-NO each)
T1	Transistor (NPN open collector: HH/H/PASS/L/LL)
T2	Transistor (PNP open collector: HH/H/PASS/L/LL)
BCD	BCD output + transistor output (NPN open collector: HH/H/PASS/L/LL)
DRT	DeviceNet

5. Control Input Specifications (K35)

Code	Control input specifications
None	None
1	Control input 5 points (M3 terminal blocks) NPN open collector
2	Control input 8 points (10-pin MIL connector) NPN open collector
3	Control input 5 points (M3 terminal blocks) PNP open collector
4	Control input 8 points (10-pin MIL connector) PNP open collector

6. Power Supply Specifications

Code	Power supply voltage
100 to 240 VAC	100 to 240 VAC, 50/60 Hz
24 VAC/VDC	24 VAC/VDC, 50/60 Hz

Note: 1) CPA and CPB can be combined with relay outputs only.

2) Only one of the following can be used by each Digital Indicator: RS-232C/RS-485 communications, BCD communications, or DeviceNet communications.

Available Output Board Combinations

Supply Voltage	Part number	Applicable sensor power supply output boards	Applicable relay/transistor/BCD/DeviceNet output boards	Applicable event input boards
100 to 240 VAC	K3HB-XVD K3HB-XAD K3HB-XVA K3HB-XAA K3HB-VLC K3HB-HTA K3HB-SSD 100-240VAC	K33-CPA K33-CPB K33-L1A K33-L2A K33-L1B K33-L2B	K34-C1 K34-C2 K34-T1 K34-T2 K34-BCD K34-DRT	K35-1 K35-2 K35-3 K35-4
24 VAC/VDC	K3HB-XVD K3HB-XAD K3HB-XVA K3HB-XAA K3HB-VLC K3HB-HTA K3HB-SSD 24VAC/VDC	K33-A K33-B K33-FLK1A K33-FLK3A K33-FLK1B K33-FLK3B	<ul style="list-style-type: none"> • CPA and CPB can be combined with relay outputs only. • Only one of communications, BCD, or DeviceNet can be used by each Digital Indicator. 	K35-1 K35-2 K35-3 K35-4

Parameter List

Enter the set value before using.

Level	Parameter name	Characters	Setting range	Characters	Initial value	Decimal point	Unit	Set value
---	Version	---	---	---	---	---	---	
	Status	---	---	---	---	---	---	
	Measurement value	---	-19999 to 99999	---	---	---	EU	
	Max. value	---	-19999 to 99999	---	---	---	EU	
	Min. value	---	-19999 to 99999	---	---	---	EU	
Protect	RUN/adjustment protect	rúnPŁ	0 to 2	0 to 2	0	---	---	
	Setting level protect	5ŁŁPŁ	0 to 2	0 to 2	1	---	---	
	Setting change protect	ŁŁPŁ	OFF, ON	0FF, 0n	0FF	---	---	
	Forced-zero protect	ŁŁPŁ	OFF, ON	0FF, 0n	0FF	---	---	
	Max/Min protect	nŁPŁ	0 to 2	0 to 2	0	---	---	
RUN	Measurement value	---	-19999 to 99999	- 19999 to 99999	---	Conforms to decimal point position.	EU	
	Forced-zero status	---	OFF, ON	--- (Not displayed.)	0FF	---	---	
	Forced-zero value	---	---	--- (Not displayed.)	0	Conforms to decimal point position.	EU	
	Tare zero status	---	OFF, ON	--- (Not displayed.)	0FF	---	---	
	Tare zero value	---	---	--- (Not displayed.)	0	Conforms to decimal point position.	EU	
	Measurement value/ comparative set value HH	---	-19999 to 99999	- 19999 to 99999	99999	Conforms to decimal point position.	EU	
	Measurement value/ comparative set value H	---	-19999 to 99999	- 19999 to 99999	99999	Conforms to decimal point position.	EU	
	Measurement value/ comparative set value L	---	-19999 to 99999	- 19999 to 99999	- 19999	Conforms to decimal point position.	EU	
Measurement value/ comparative set value LL	---	-19999 to 99999	- 19999 to 99999	- 19999	Conforms to decimal point position.	EU		
Adjustment	Bank	bŁnŁ	0 to 7	0 to 7	0	---	---	
	Communication write	ŁŁŁŁ	OFF, ON	0FF, 0n	0FF	---	---	

Level	Parameter name	Characters	Setting range	Characters	Initial value	Decimal point	Unit	Set value
Initial setting	Calculation	ƒRL	A, B, K-A, A+B, K-(A+B), B/A×10000, (B/A-1)×10000	0, 1, 2, 3, 4, 5, 6, 7	R	---	---	
	Input type A	ƒn-tR	X(VD): ±199.99 V, ±19.999 V, ±1.9999 V, 1.0000 to 5.0000 V X (AD): ±199.99 mA, ±19.999 mA, ±1.9999 mA, 4.000 to 20.000 mA X (VA): 0.0 to 400.0 V, 0.00 to 199.99 V, 0.0000 to 19.999 V, 0.0000 to 1.9999 V X (AA): 0.000 to 10.000 A, 0.0000 to 1.9999 A, 0.00 to 199.99 mA, 0.000 to 19.999 mA V: 0.00 to 199.99 mV, ±1 0.000 to 19.999 mV, ±1	X (VD): R ud, b ud, ƒ ud, d ud X (AD): R Rd, b Rd, ƒ Rd, d Rd X (VA): R uR, b uR, ƒ uR, d uR X (AA): R RR, b RR, ƒ RR, d RR V: R Lƒ, b Lƒ, ƒ Lƒ, d Lƒ S: 0-20, 4-20, 0-5, 1-5, 5, 10 H: 0-Pt, 1-Pt, 2-P, 3-P, 4-3, 5-3, 6-E, 7-E, 8-L, 9-U, 10-n, 11-r, 12-5, 13-b, 14-y	X (VD): R ud X (AD): R Rd X (VA): R uR X (AA): R RR V: R Lƒ S: 4-20 H: 2-P	---	---	
	Power supply frequency	FrE	50, 60	50, 60	50	---	Hz	
	Scaling input value A1	ƒnP. R1	-19999 to 99999	- 19999 to 99999	X (VD): - 199.99 X (AD): - 199.99 X (VA): 0.0 X (AA): 0.000 V: 0.00 S: 4.000	Conforms to input type.	Conforms to input type.	
	Scaling display value A1	d5P. R1	-19999 to 99999	- 19999 to 99999	X (VD): - 19999 X (AD): - 19999 X (VA): 0 X (AA): 0 V: 0 S: 4.000	---	EU	
	Scaling input value A2	ƒnP. R2	-19999 to 99999	- 19999 to 99999	X (VD): 199.99 X (AD): 199.99 X (VA): 400.0 X (AA): 10.000 V: 199.99 S: 20.000	Conforms to input type.	Conforms to input type.	
	Scaling display value A2	d5P. R2	-19999 to 99999	- 19999 to 99999	X (VD): 19999 X (AD): 19999 X (VA): 40000 X (AA): 10000 V: 19999 S: 20000	---	EU	
	Input type B	ƒn-tb	0 to 20 mA, 4 to 20 mA, 0 to 5 V, 1 to 5 V, ±5 V, ±10 V	0-20, 4-20, 0-5, 1-5, 5, 10	4-20	---	---	
	Scaling input value B1	ƒnP.b 1	-19999 to 99999	- 19999 to 99999	4000	Conforms to input type.	Conforms to input type.	
	Scaling display value B1	d5P.b 1	-19999 to 99999	- 19999 to 99999	4000	---	EU	
	Scaling input value B2	ƒnP.b2	-19999 to 99999	- 19999 to 99999	20000	Conforms to input type.	Conforms to input type.	
	Scaling display value B2	d5P.b2	-19999 to 99999	- 19999 to 99999	20000	---	EU	
	Constant K	K	-19999 to 99999	- 19999 to 99999	0	---	EU	
	Decimal point position	dP	0 to 4	00000, 0000.0, 000.00, 00.000, 0.0000	X (VD): 2 X (AD): 2 X (VA): 1 X (AA): 3 V: 2 S: 3	---	---	
	Temperature unit	d-U	°C, °F	°C, °F	°C	---	---	
	Comparative output pattern	ãU-t-P	Standard outputs, zone outputs, level outputs	nãr-ãRL, ËãnE, LÈuÈL	nãr-ãRL	---	---	
Move to the advanced function setting level	Rããu	-19999 to 99999	- 19999 to 99999	0	---	---		

Level	Parameter name	Characters	Setting range	Characters	Initial value	Decimal point	Unit	Set value
Input adjustment	Timing hold	ḧñĦ-H	Normal, sampling, peak, bottom, peak to peak	ñḧñḖḖ, Ḗ-H, P-H, b-H, P-P	ñḧñḖḖ	---	---	
	ON timing delay	ḧñ-ḧ	0 to 4999	Ḗ to 4999	Ḗ	---	S: ms, Other models: 100 ms	
	OFF timing delay	ḧFF-ḧ	0 to 4999	Ḗ to 4999	Ḗ	---	S: ms, Other models: 100 ms	
	Zero-limit	Ḗ-ḖḖḖ	off, on	ḧFF, ḧñ	ḧFF	---	---	
	Zero limit value	ḖḖḖ-P	0 to 99	Ḗ to 99	Ḗ	Conforms to decimal point position.	EU	
	Step value	ḖḖḖP	off, 2, 5, 10	ḧFF, 2, 5, 10	ḧFF	---	digit	
	Average type	ḖḖḖ-ḧ	Simple average, moving average	ḖñḖḖ, ḖḖḖḖ	ḖñḖḖ	---	---	
	Averaging times	ḖḖḖ-Ḗ	1/2/4/8/16/32/64/128/256/512/1024	1, 2, 4, 8, 16, 32, 64, 128, 256, 512, 1024	1	---	---	
	Input shift input 1		-9999 to 99999	- 19999 to 99999	-2000 Ḗ	Conforms to input type.	EU	
	Input shift value 1		-19999 to 99999	- 19999 to 99999	Ḗ Ḗ	2	EU	
	Input shift input 2		-19999 to 99999	- 19999 to 99999	1300 Ḗ	Conforms to input type.	EU	
	Input shift value 2		-19999 to 99999	- 19999 to 99999	Ḗ Ḗ	2	EU	
Power supply memory		off, on	ḧFF, ḧñ	ḧFF	---	---		
Display adjustment	Comparative set value display	ḖḖḖḖP	off, on	ḧFF	ḧFF	---	---	
	Display refresh period	ḖḖḖḖ	off, 0.5 s, 1 s, 2 s, 4 s	ḧFF, ḖḖ, 1, 2, 4	ḧFF	---	s	
	Display color selection	ḖḖḖḖḖ	Green (red), green, red (green), red	ḖḖḖḖḖ, ḖḖḖḖḖ, ḖḖḖḖḖ, ḖḖḖḖḖ	ḖḖḖḖḖ	---	---	
	Display value selection	ḖḖḖḖP	PV, max, min	ḖḖ, ḖḖḖḖ, ḖḖḖḖ	ḖḖ	---	---	
	Automatic display return	ḖḖḖḖ	0 to 99	Ḗ to 99	10	---	s	
	Position meter type	ḖḖḖḖ-ḧ	OFF, incremental, incremental (reversed), deviation, deviation (reversed)	ḧFF, ḖḖḖḖ, ḖḖḖḖḖḖ, ḖḖḖḖḖḖ, ḖḖḖḖḖḖḖ	ḖḖḖḖ	---	---	
	Position meter upper limit	ḖḖḖḖ-H	-19999 to 99999	- 99999 to 99999	X (VD): 19999 X (AD): 19999 X (VA): 40000 X (AA): 100000 V: 19999 S: 99999 H: 1300 Ḗ	Conforms to decimal point position.	EU	
	Position meter lower limit	ḖḖḖḖ-L	-19999 to 99999	- 19999 to 99999	X (VD): 9999 X (AD): 9999 X (VA): Ḗ X (AA): Ḗ V: Ḗ S: 9999 H: 200 Ḗ	Conforms to decimal point position.	EU	
PV decimal point display	ḖḖḖḖP	off, on	ḧFF, ḧñ	ḧñ	---	---		

Level	Parameter name	Characters	Setting range	Characters	Initial value	Decimal point	Unit	Set value
Comparative set value display	Comparative set value bank	50.b0P	0 to 7	0 to 7	0	---	---	
	Comparative set value 0HH	50.0HH	-19999 to 99999	- 99999 to 99999	99999	Conforms to decimal point position.	EU	
	Comparative set value 0H	50.0H	-19999 to 99999	- 99999 to 99999	99999	Conforms to decimal point position.	EU	
	Comparative set value 0L	50.0L	-19999 to 99999	- 99999 to 99999	- 99999	Conforms to decimal point position.	EU	
	Comparative set value 0LL	50.0L L	-19999 to 99999	- 99999 to 99999	- 99999	Conforms to decimal point position.	EU	
	Comparative set value 1HH	50.1HH	-19999 to 99999	- 99999 to 99999	99999	Conforms to decimal point position.	EU	
	Comparative set value 1H	50.1H	-19999 to 99999	- 99999 to 99999	99999	Conforms to decimal point position.	EU	
	Comparative set value 1L	50.1L	-19999 to 99999	- 99999 to 99999	- 99999	Conforms to decimal point position.	EU	
	Comparative set value 1LL	50.1L L	-19999 to 99999	- 99999 to 99999	- 99999	Conforms to decimal point position.	EU	
	Comparative set value 2HH	50.2HH	-19999 to 99999	- 99999 to 99999	99999	Conforms to decimal point position.	EU	
	Comparative set value 2H	50.2H	-19999 to 99999	- 99999 to 99999	99999	Conforms to decimal point position.	EU	
	Comparative set value 2L	50.2L	-19999 to 99999	- 99999 to 99999	- 99999	Conforms to decimal point position.	EU	
	Comparative set value 2LL	50.2L L	-19999 to 99999	- 99999 to 99999	- 99999	Conforms to decimal point position.	EU	
	Comparative set value 3HH	50.3HH	-19999 to 99999	- 99999 to 99999	99999	Conforms to decimal point position.	EU	
	Comparative set value 3H	50.3H	-19999 to 99999	- 99999 to 99999	99999	Conforms to decimal point position.	EU	
	Comparative set value 3L	50.3L	-19999 to 99999	- 99999 to 99999	- 99999	Conforms to decimal point position.	EU	
	Comparative set value 3LL	50.3L L	-19999 to 99999	- 99999 to 99999	- 99999	Conforms to decimal point position.	EU	
	Comparative set value 4HH	50.4HH	-19999 to 99999	- 99999 to 99999	99999	Conforms to decimal point position.	EU	
	Comparative set value 4H	50.4H	-19999 to 99999	- 99999 to 99999	99999	Conforms to decimal point position.	EU	
	Comparative set value 4L	50.4L	-19999 to 99999	- 99999 to 99999	- 99999	Conforms to decimal point position.	EU	
	Comparative set value 4LL	50.4L L	-19999 to 99999	- 99999 to 99999	- 99999	Conforms to decimal point position.	EU	
	Comparative set value 5HH	50.5HH	-19999 to 99999	- 99999 to 99999	99999	Conforms to decimal point position.	EU	
	Comparative set value 5H	50.5H	-19999 to 99999	- 99999 to 99999	99999	Conforms to decimal point position.	EU	
	Comparative set value 5L	50.5L	-19999 to 99999	- 99999 to 99999	- 99999	Conforms to decimal point position.	EU	
	Comparative set value 5LL	50.5L L	-19999 to 99999	- 99999 to 99999	- 99999	Conforms to decimal point position.	EU	
	Comparative set value 6HH	50.6HH	-19999 to 99999	- 99999 to 99999	99999	Conforms to decimal point position.	EU	
	Comparative set value 6H	50.6H	-19999 to 99999	- 99999 to 99999	99999	Conforms to decimal point position.	EU	
	Comparative set value 6L	50.6L	-19999 to 99999	- 99999 to 99999	- 99999	Conforms to decimal point position.	EU	
	Comparative set value 6LL	50.6L L	-19999 to 99999	- 99999 to 99999	- 99999	Conforms to decimal point position.	EU	
	Comparative set value 7HH	50.7HH	-19999 to 99999	- 99999 to 99999	99999	Conforms to decimal point position.	EU	
Comparative set value 7H	50.7H	-19999 to 99999	- 99999 to 99999	99999	Conforms to decimal point position.	EU		
Comparative set value 7L	50.7L	-19999 to 99999	- 99999 to 99999	- 99999	Conforms to decimal point position.	EU		
Comparative set value 7LL	50.7L L	-19999 to 99999	- 99999 to 99999	- 99999	Conforms to decimal point position.	EU		
Bank copy	50.PY	off, on	0FF, 0n	0FF	---	---	---	

Level	Parameter name	Characters	Setting range	Characters	Initial value	Decimal point	Unit	Set value
Linear output	Linear current type	ISEE.L	0-20 mA, 4-20 mA	0-20, 4-20	4-20	---	---	
	Linear voltage type	ISEE.U	0-5 V, 1-5 V, 0-10 V	0-5, 1-5, 0-10	1-5	---	---	
	Linear output upper limit	ISEE.H	-19999 to 99999	-19999 to 99999	X (VD): 19999 X (AD): 19999 X (VA): 40000 X (AA): 10000 V: 19999 S: 19999 H: 1000.0	Conforms to decimal point position.	EU	
	Linear output lower limit	ISEE.L	-19999 to 99999	-19999 to 99999	X (VD): -19999 X (AD): -19999 X (VA): 0 X (AA): 0 V: 0 S: -19999 H: -2000.0	Conforms to decimal point position.	EU	
Communications settings	Communications protocol	PRad	CompoWay/F, Modbus	EVF, Rad	EVF	---	---	
	Communications unit number	U-na	0 to 99	0 to 99	1	---	---	
	Baud rate	bP5	9.6, 19.2, 38.4	9.6, 19.2, 38.4	9.6	---	kbps	
	Communications data length	LEn	7, 8	7, 8	7	---	bit	
	Communications stop bits	SbL	1, 2	1, 2	2	---	bit	
	Communications parity	PtY	None, even, odd	nanE, EUn, odd	nanE	---	---	
	Send wait time	SdYt	0 to 99	0 to 99	20	---	ms	
Output test	Test input	EESt	OFF, -19999 to 99999	oFF, -19999 to 99999	oFF	Conforms to decimal point position.	EU	
Advanced function settings	Set value initialization	LnL	OFF, ON	oFF, on	oFF	---	---	
	PASS output change	PR55	LL, L, PASS, H, HH, ERR	L, L, PR55, H, HH, Err	PR55	---	---	
	Hysteresis	HY5	0 to 9999	0 to 9999	1	Conforms to decimal point position.	EU	
	Output OFF delay	oFF-d	0 to 1999	0 to 1999	0	---	S: ms, Other models: 100 ms	
	Shot output	SHoL	0 to 1999	0 to 1999	0	---	S: ms, Other models: 100 ms	
	Output logic	oUt-n	Close in alarm, open in alarm	n-o, n-L	n-o	---	---	
	Output refresh stop	o-5tP	OFF, OUT, ALL	oFF, oUt, All	oFF	---	---	
	Tare zero	t-zr	OFF, ON	oFF, on	oFF	---	---	
	Zero trimming	z-trn	OFF, ON	oFF, on	oFF	---	---	
	Previous average value comparison	HP-F	OFF, ON	oFF, on	oFF	---	---	
	Bank selection	bnP-L	OFF, KEY, EV	oFF, PEY, EU	oFF*	---	---	
	Startup compensation timer	S-tAr	0.0 to 99.9	0.0 to 99.9	0.0	1	s	
	Operation at input error	SErr	OFF, overflow, input error	oFF, oUEr, SErr	SErr	---	---	
	Standby sequence	StdbY	OFF, ON	oFF, on	oFF	---	---	
	Cold junction compensation	CJL	OFF, ON	oFF, on	on	---	---	
Move to the calibration level.	CnaU	-19999 to 99999	-19999 to 99999	0	---	---		
Others	Linear output calibration value H	---	---	---	---	---	---	
	Linear output calibration value L	---	---	---	---	---	---	

*1 Variable C0 is sued for reading communications data.

*2 Set the “bank” parameter to “EV” when an event input (connector) is mounted as a standard feature or has been added.

Parameter Display Conditions

Level	Parameter name	Characters	Model				Unit										Setting Conditions			
			X	V	S	H	<K35-1> <K35-2> <K35-3> <K35-4>	<K34-C1>	<K34-C2>	T1> <K34-BCD>	<K34-CPA>	<K33-L1A>	<K33-L2A>	<K33-FLK1A/2> <K33-FLK1B/2> <K33-FLK2A/2B>	<K34-DRT>					
Protect	RUN adjustment protect	rUnPs																		
	Setting level protect	SEsPs																		
	Setting change protect	ScPs																		
	Forced-zero protect	ZrPs				X														
	Max./Min. protect	MSPs																		
RUN	Measurement value	mVal																	PASS output change = PASS or ERR	
	Measurement value/comparative set value H	mValH																	When the Output Unit is only <CPA/B>, change in PASS output = HH.	
	Measurement value/comparative set value H	mValH																	When the Output Unit is only <CPA>, change in PASS output = H.	
	Measurement value/comparative set value L	mValL																	When the Output Unit is only <CPA/B>, change in PASS output = LL.	
	Measurement value/comparative set value L	mValL																	When the Output Unit is only <CPA>, change in PASS output = L.	
Adjustment	Bank	bnPs																	Bank selection = KEY	
	Communication write	cgPs																	When the Output Unit is <CPA>, change in PASS output = PASS or ERR.	
Initialization	Calculation	clPs	X	X	X	X													Calculation = B (Always displayed for X/V/H)	
	Input type A	lnPsA	X	X	X	X													Calculation = B (Always displayed for X/V)	
	Power supply frequency	FsPs	X	X	X	X													Calculation = B (Always displayed for X/V)	
	Scaling input value A1	lnPsA1	X	X	X	X													Calculation = B (Always displayed for X/V)	
	Scaling display value A1	dSPsA1	X	X	X	X													Calculation = B (Always displayed for X/V)	
	Scaling input value A2	lnPsA2	X	X	X	X													Calculation = B (Always displayed for X/V)	
	Scaling display value A2	dSPsA2	X	X	X	X													Calculation = B (Always displayed for X/V)	
	Input type B	lnPsB	X	X	X	X													Calculation = A or K-A	
	Scaling input value B1	lnPsB1	X	X	X	X													Calculation = A or K-A	
	Scaling display value B1	dSPsB1	X	X	X	X													Calculation = A or K-A	
	Scaling input value B2	lnPsB2	X	X	X	X													Calculation = A or K-A	
	Scaling display value B2	dSPsB2	X	X	X	X													Calculation = A or K-A	
	Constant K	KPs	X	X	X	X													Calculation = K-A or K-(A+B)	
	Decimal point position	dPs	X	X	X	X														
Temperature unit	dU	X	X	X	X															
Comparative output pattern	dUtPs																		When the Output Unit is <CPA>, change in PASS output = PASS or ERR.	
Move to the status/function setting level	RnPs																		Setting level protect = 0	
Input adjustment	Timing hold	tnPsH																		
	ON timing delay	dnPs																	Timing hold = Normal	
	OFF timing delay	dFPs																	Timing hold = Normal or sampling	
	Zero-limit	zlPs																	Zero limit = ON	
	Zero-limit value	zlVPs																		
	Step value	StPs																		
	Average type	AvPs																		
	Averaging times	AvTPs																		
	Input compensation input value 1	ic1Ps	X	X	X	X														
	Input compensation value 1	ic1VPs	X	X	X	X														
	Input compensation input value 2	ic2Ps	X	X	X	X														
	Input compensation value 2	ic2VPs	X	X	X	X														
	Power interruption memory	riPs																		
	Display adjustment	Comparative set value display	SuPs																	When the Output Unit is <CPA>, change in PASS output = PASS or ERR.
Display refresh period		dRPs																		
Display color selection		dCPs																		
Display value selection		dVPs																		
Automatic display return		rEtPs																		
Position meter type		PmPs																	Position meter type = OFF	
Position meter upper limit		PmUPPs																	Position meter type = OFF	
Position meter lower limit		PmLPs																		
PV decimal point display		PvDPPs	X	X	X	X														
Comparative set value		Comparative set value bank	SuBnPs																	Switching banks
		Comparative set value	SuPs																	When the Output Unit is <CPA>, change in PASS output = PASS or ERR.
		+H (+0 to 7)	SuHPs																	+ is the value between 0 and 7 set on the comparative set value bank.
		Comparative set value	SuPs																	When the Output Unit is only <CPA>, change in PASS output = H.
		+H (+0 to 7)	SuHPs																	+ is the value between 0 and 7 set on the comparative set value bank.
	Comparative set value	SuPs																	When the Output Unit is only <CPA>, change in PASS output = L.	
	+L (+0 to 7)	SuLPs																	+ is the value between 0 and 7 set on the comparative set value bank.	
	Comparative set value	SuPs																	When the Output Unit is only <CPA>, change in PASS output = LL.	
+L (+0 to 7)	SuLPs																	+ is the value between 0 and 7 set on the comparative set value bank.		
Linear output	Bank copy	cgPs																	Switching banks	
	Linear current type	LSsI																	When the Output Unit is <CPA>, change in PASS output = PASS or ERR.	
	Linear voltage type	LSsV																		
	Linear output upper limit	LSsUp																		
	Linear output lower limit	LSsLp																		
Communications settings	Communications unit No.	Ums																		
	Baud rate	brPs																		
	Communications data length	LnPs																		
	Communications stop bits	SBPs																		
	Communications parity	PrPs																		
Output test	Communications wait time	SdPs																		
	Test input	tEsPs																		
Advanced function setting	Set value initialization	LnPsI																		
	PASS output change	PHsS																		
	Hysteresis	HYPs																		
	Output OFF delay	dFFPs																	When the Output Unit is <CPA>, change in PASS output = PASS or ERR.	
	Shot output	SHsL																		
	Output logic	dUtPs																		
	Output refresh stop	rSPs																		
	Time zero	tZPs																		
	Zero-point offset	ZPOPs																		
	Previous average comparison	MPsF																	Timing hold = sampling, peak, or bottom.	
	Bank selection	bnPsC																	When the Output Unit is <CPA/B>, change in PASS output = PASS or ERR.	
	Startup compensation timer	S-ePs																		
	Operation at input error	S-ePs																		
	Standby sequence	SbPs																	When the Output Unit is <CPA/B>, change in PASS output = PASS or ERR.	
Cold junction compensation	CcPs	X	X	X	X															
Move to the calibration level	CnPs																			

- <K35-1 to 4> Event Input
- <K34-C1> Relay Output (H/L)
- <K34-C2> Relay Output (HH/H/L/LL)
- <K34-T1/T2> Transistor Output
- <K34-BCD> BCD Output
- <K33-CPA/B> PASS Output
- <K33-L1A/B> Linear Current Output
- <K33-L2A/B> Linear Voltage Output
- <K33-FLK1A/B> RS-232C
- <K33-FLK2A/B> RS-485
- <K34-DRT> DeviceNet

● Items marked may not be displayed due to Unit configuration or settings. Others are always displayed.
 ● Displayed if the Unit is connected.
 ▲ Displayed if the Unit is connected and the setting conditions are met.

About Parameters

K3HB-X

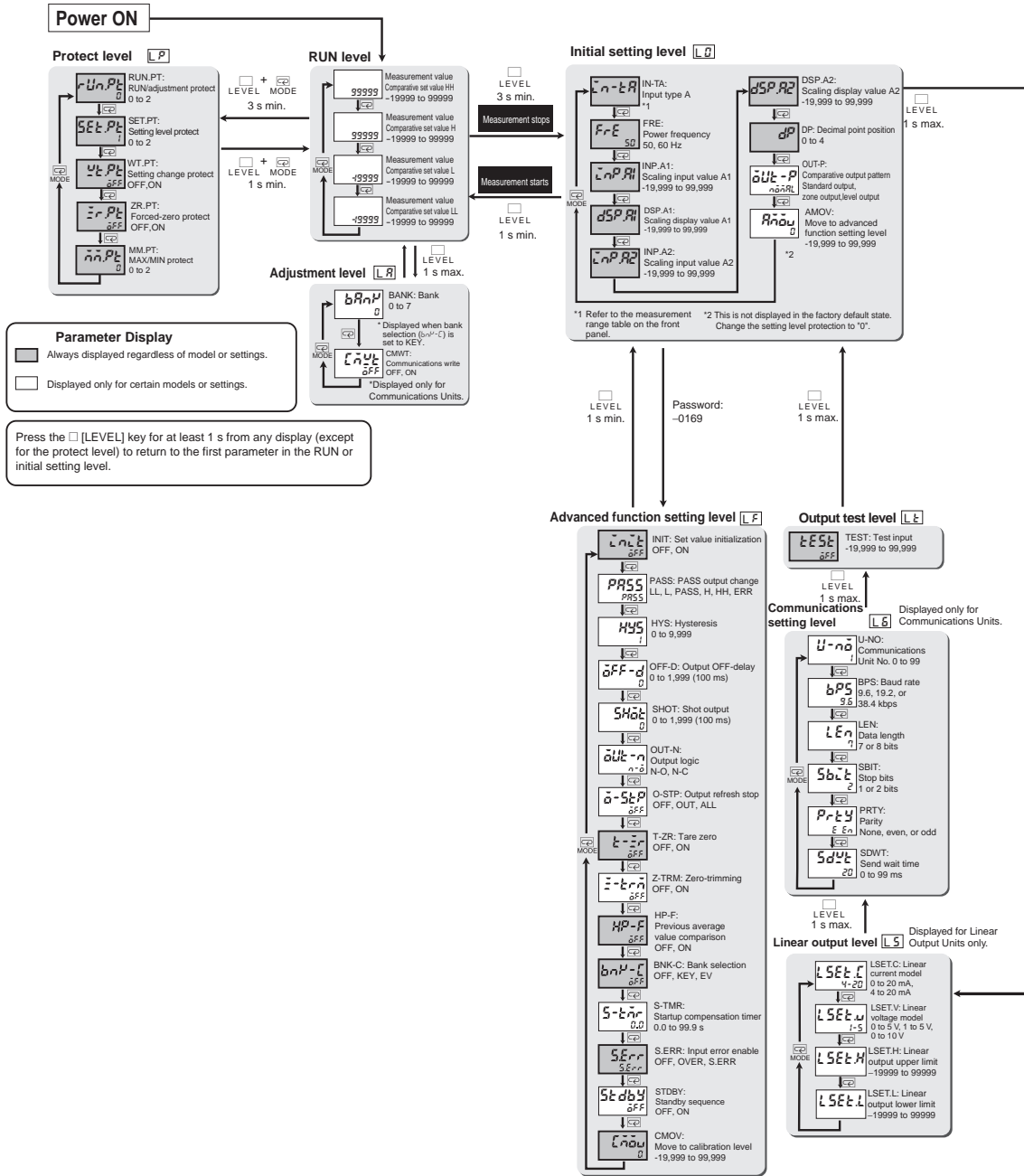

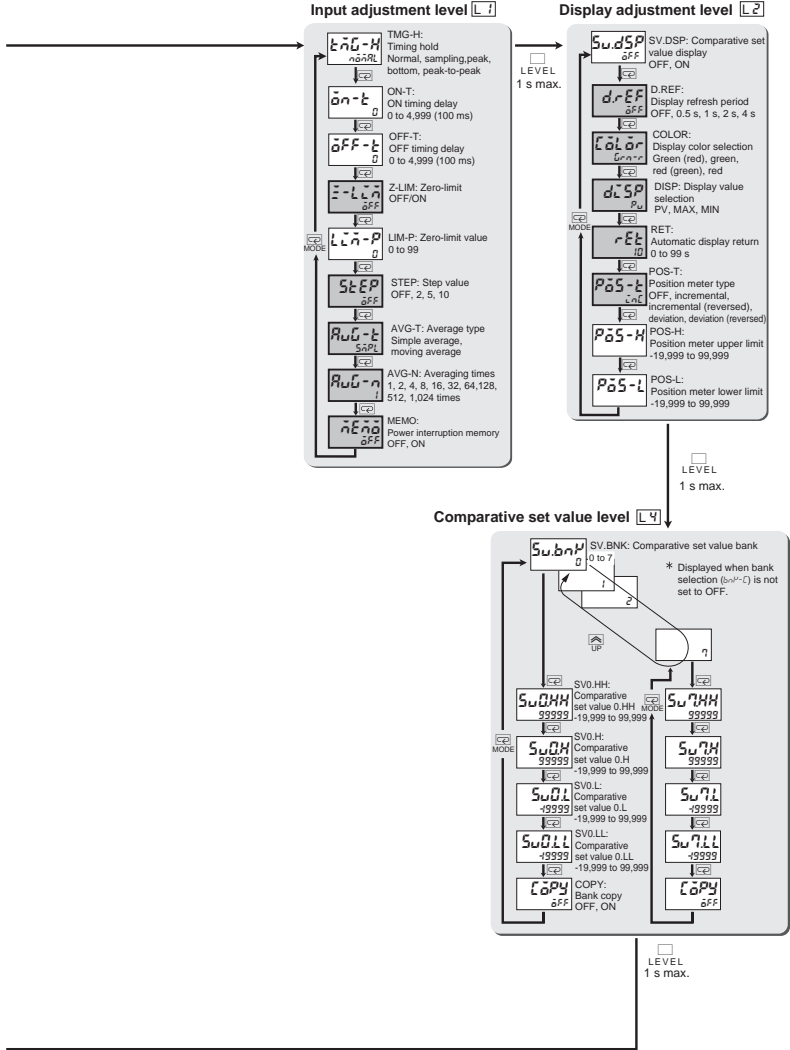

Changing the Settings

Use the following method to change the settings.

Monitor mode

12345
4000

→

Edit mode

12345
-04000

←

To next parameter.

Use the **[Left]** **[Right]** Keys to change the settings. The setting to be changed will flash.

*If a key is not pressed within 5 s, the present setting will be saved and the display will return to monitor mode.

K3HB-V

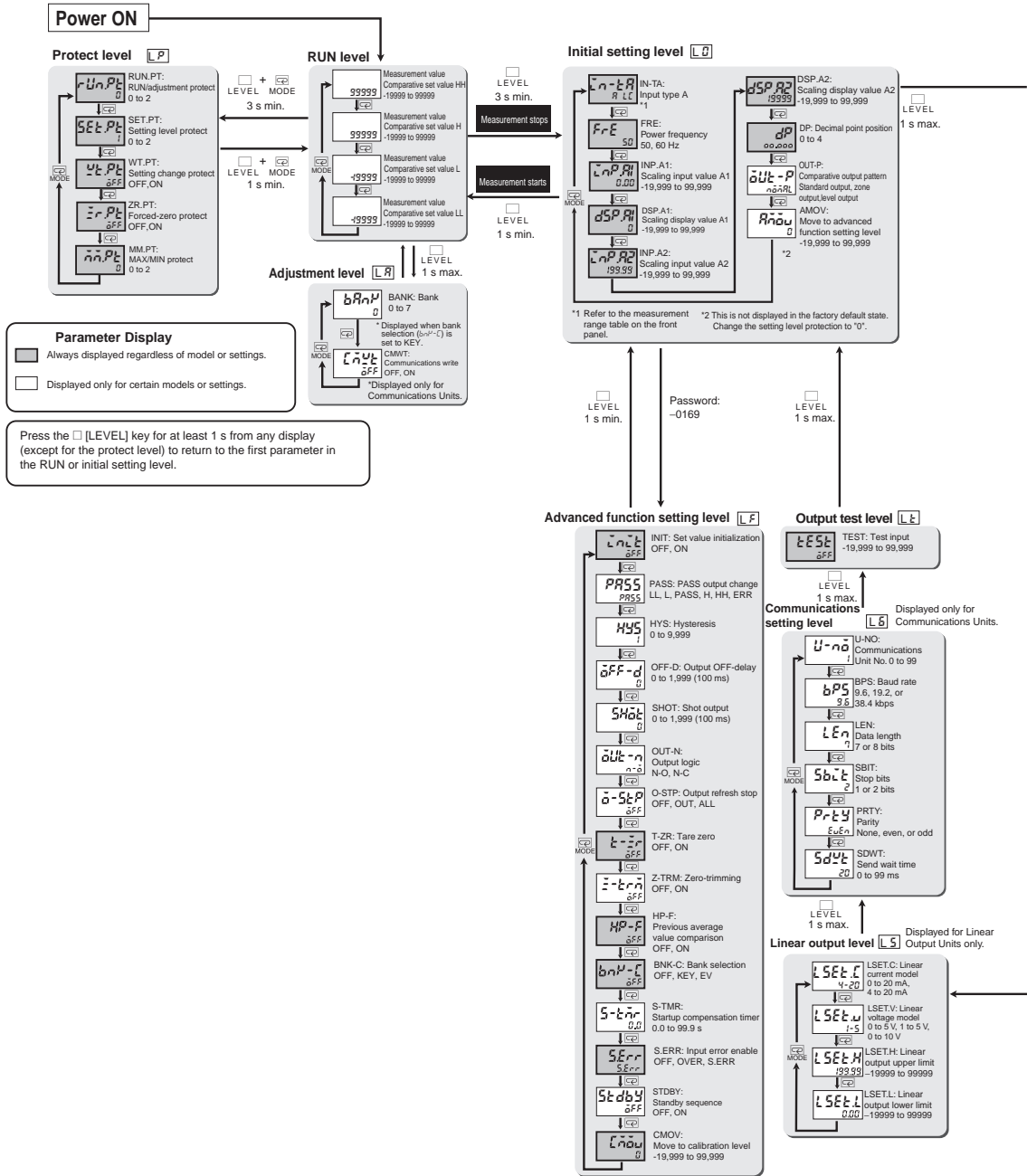

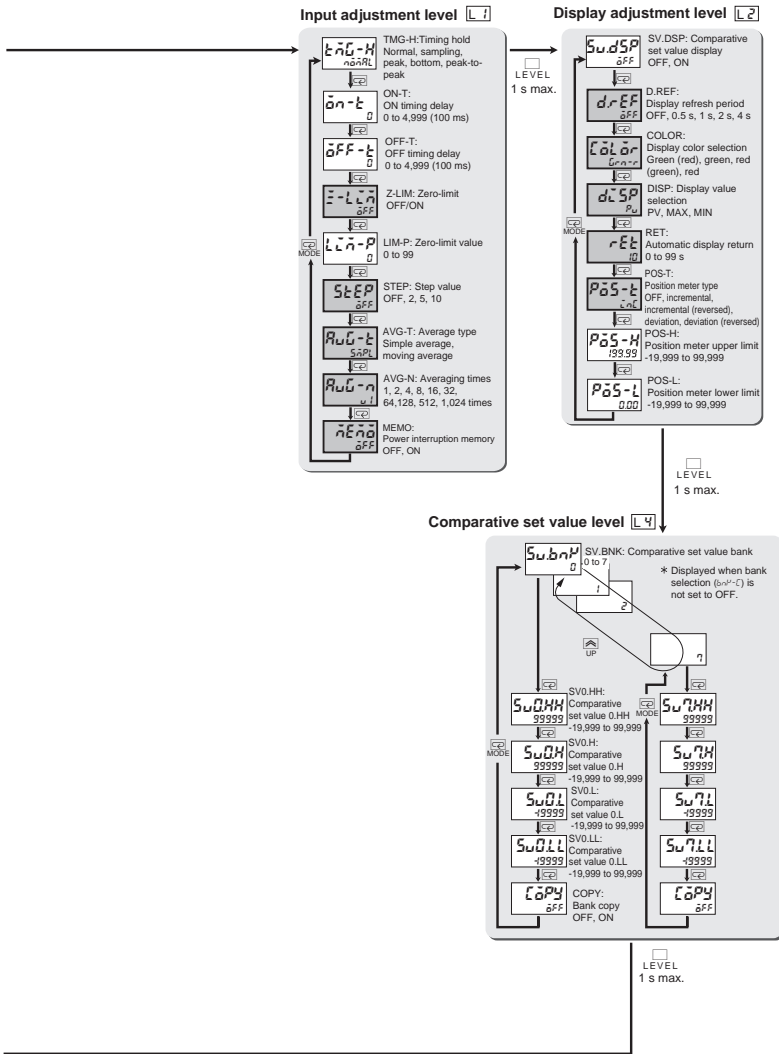

Changing the Settings

Use the following method to change the settings.

Monitor mode

12345
4000

→

Edit mode

12345
04000

Use the \leftarrow \rightarrow Keys to change the settings. The setting to be changed will flash.

*If a key is not pressed within 5 s, the present setting will be saved and the display will return to monitor mode.

To next parameter.

K3HB-S

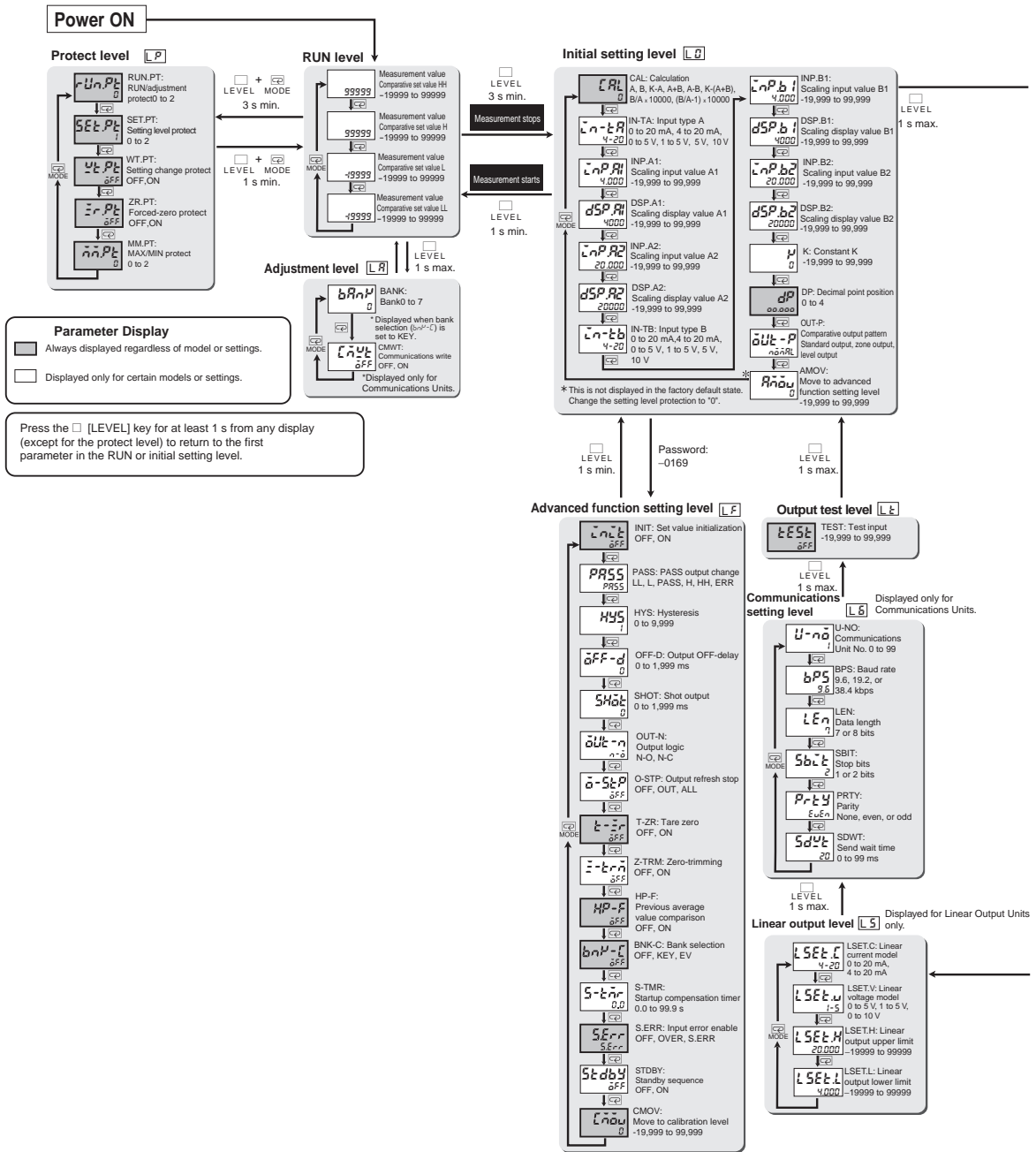

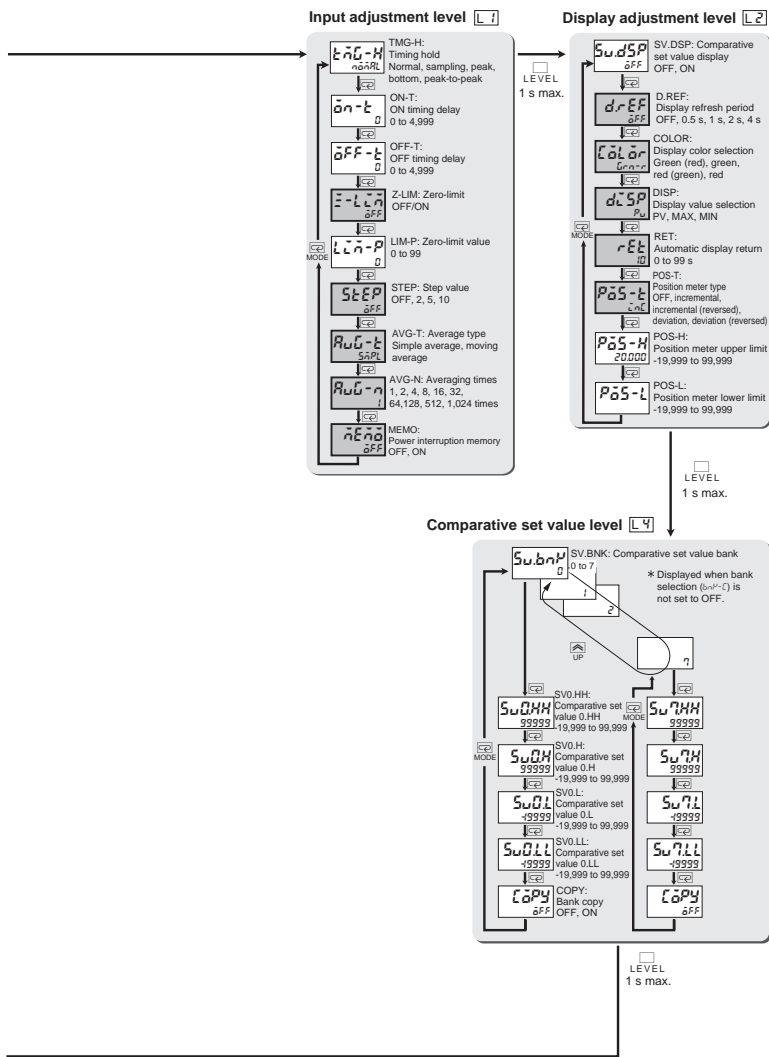

Changing the Settings
 Use the following method to change the settings.

Monitor mode:

→

Edit mode:

Use the Keys to change the settings. The setting to be changed will flash.

*If a key is not pressed within 5 s, the present setting will be saved and the display will return to monitor mode.

↓

To next parameter.

K3HB-H

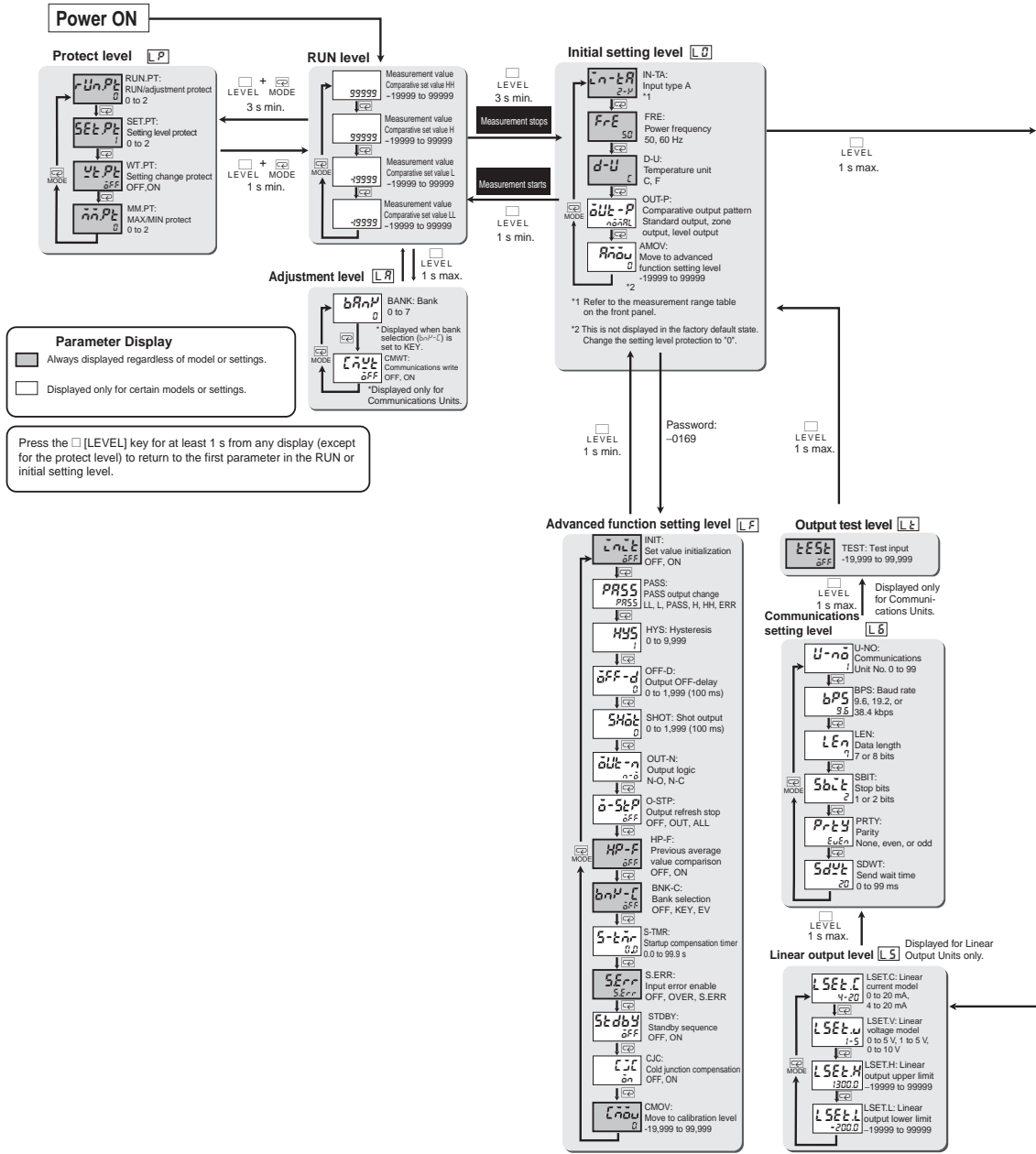

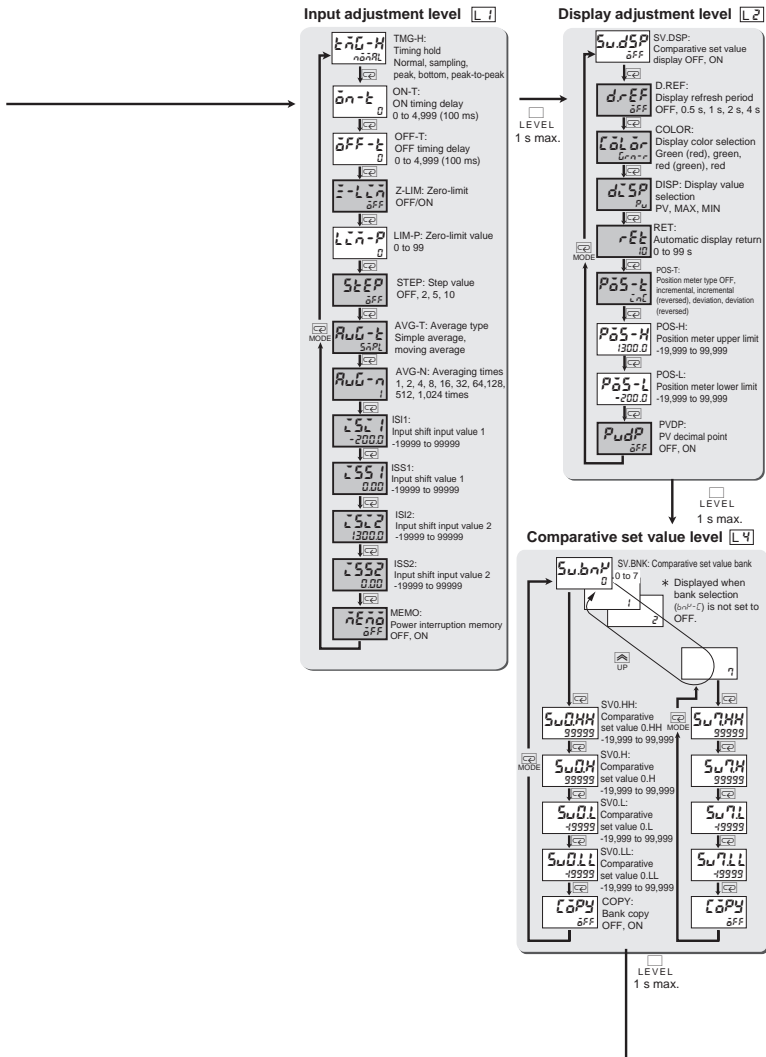

Changing the Settings

Use the following method to change the settings.

Monitor mode

12345
4000

→

Edit mode

12345
04000

Use the \leftarrow \rightarrow Keys to change the settings. The setting to be changed will flash.

*If a key is not pressed within 5 s, the present setting will be saved and the display will return to monitor mode.

To next parameter.

Sampling and Comparative Output Response Times

The K3HB-S sampling and comparative output response times depend on the calculations, timing hold type, and, for simple averaging, the averaging times. Refer to the following description for details.

■ Output Refresh Period

The K3HB-S repeats input reads, calculation, and judgement output processing. The output refresh period differs depending on whether there are one or two inputs, as outlined below.

● One input

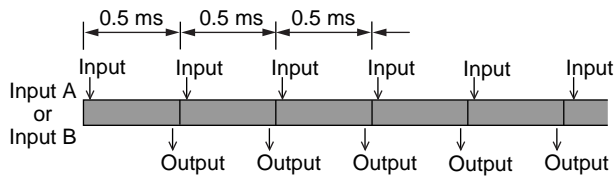

Input read	Every 0.5 ms
Output refresh	Every 0.5 ms

● Two inputs

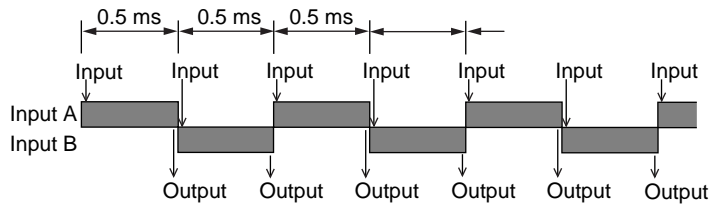

Input read	Input A: every 1 ms
	Input B: every 1 ms
Output refresh	Every 0.5 ms

Output Response Time

The comparative output response time is the sum of the data processing time and the output (relay or transistor) response time.

One input

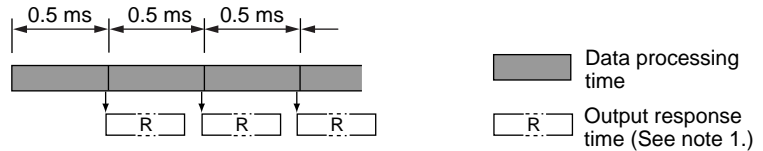

Two inputs

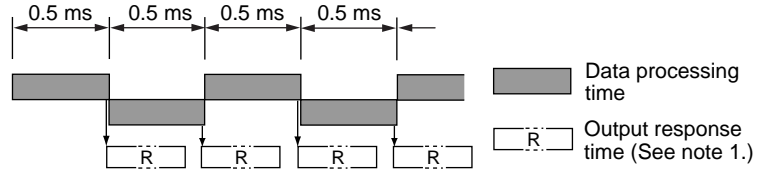

(Note 1.)

For transistor outputs

For one input: OFF → ON 1 ms and ON → OFF 1.5 ms

For two inputs: OFF → ON 2 ms and ON → OFF 2.5 ms

For relay outputs

The relay operation time of 10 ms is added to the transistor output response times.

Operation Timing Examples

Example 1

The Unit operates as shown in the diagram to the right for the settings shown in the table below.

Calculation	A
Timing hold mode	Normal
Averaging times (n)	Once

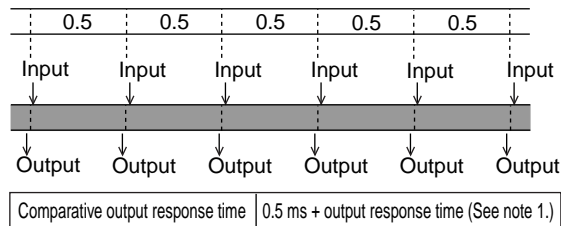

Example 2

The Unit operates as shown in the diagram to the right for the settings shown in the table below.

Calculation	A+B
Timing hold mode	Normal
Averaging times (n)	Once

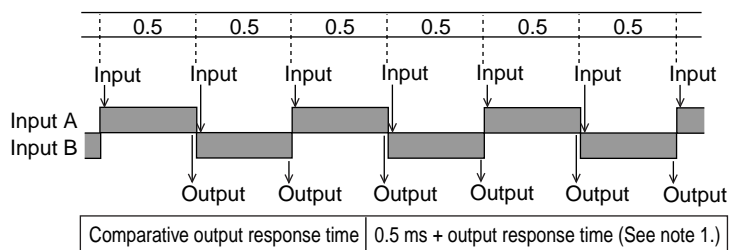

* The output every 0.5 ms is the comparative output corresponding to the input change for either input A or input B. The input change for both inputs is reflected in the comparative outputs every 1 ms.

Example 3

The Unit operates as shown in the diagram to the right for the settings shown in the table below.

Calculation	A+B
Timing hold mode	Normal
Averaging times (n)	8 times simple averaging

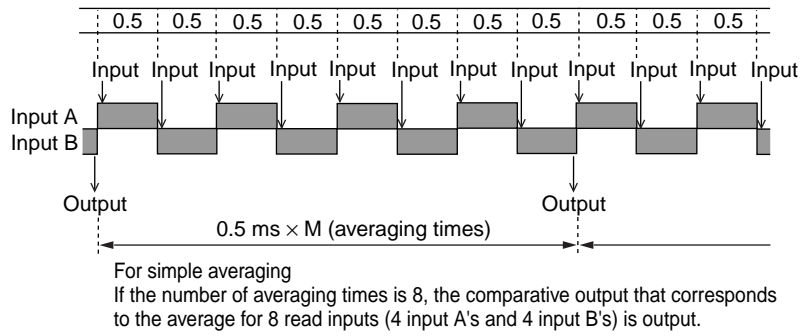

Comparative output response time	4 ms + output response time (See note 1.) = 0.5 ms × M (averaging times) + output response time (See note 1.)
----------------------------------	------------------------------------------------------------------------------------------------------------------

Example 4

The Unit operates as shown in the diagram to the right for the settings shown in the table below.

Calculation	A
Timing hold mode	Sampling hold
Averaging times (n)	Once

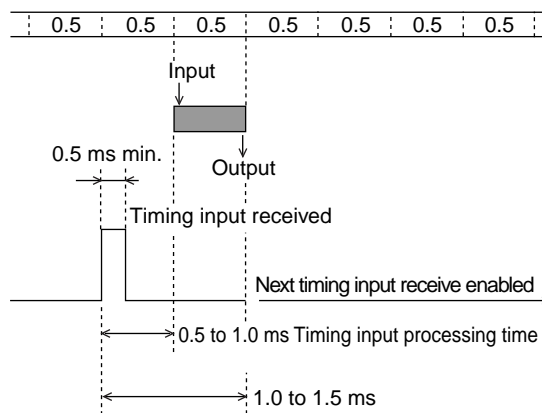

Comparative output response time	1.0 to 1.5 ms + output response time (See note 1.)
----------------------------------	----------------------------------------------------

Example 5

The Unit operates as shown in the diagram to the right for the settings shown in the table below.

Calculation	A+B
Timing hold mode	Peak hold
Averaging times (n)	Once

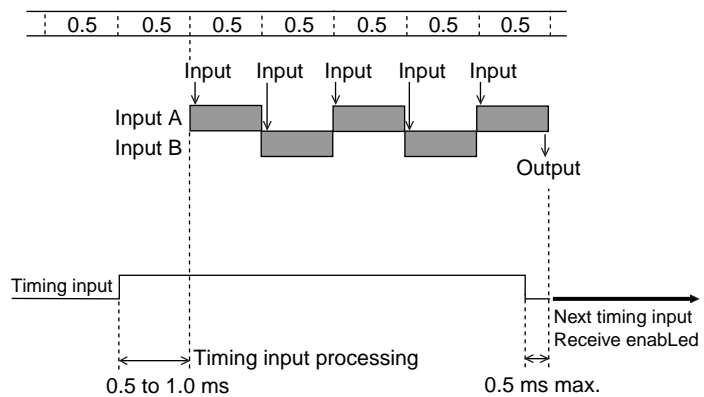

Comparative output response time	0.5 ms max. + output response time (See note 1.)
----------------------------------	--------------------------------------------------

■ Relationship between Timing Signals and Reset or Hold Signals

The following tables show whether or not measurement is performed for each signals timing input, when timing hold is not set to normal.

● Timing Signal and Reset Signal

TIMING				
RESET				
Sampling	Measured → Not measured	Measured → Not measured	Measurement not possible	Measurement not possible
Other	Measurement cancelled	Measurement cancelled	Measurement cancelled	Measurement cancelled

● Timing Signal and Hold Signal

TIMING				
HOLD				
Sampling	Measurement	Measurement	Measurement	Measurement not possible

TIMING				
HOLD				
Other	Measurement	Measurement	Measurement	Measurement not possible

No Measurement Status

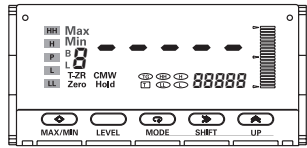

- PV display "-----"
- All outputs OFF

When no measurement value has been determined, a “no measurement” status exists. The PV display for no measurement is “-----” and all outputs are OFF.

A no measurement status occurs in the following circumstances.

- When the power is turned ON during timing hold mode, RESET input, or startup compensation timer operation.
- Immediately after returning to RUN level from any level other than the protect and adjustment levels during timing hold mode, RESET input, or startup compensation timer operation.
- When the \diamond [MAX/MIN] Key is pressed for at least 1 s.

* If the hold signal turns ON when no measurement has been made, the no measurement status is held.

INDEX

A

Adjustment 5-2, 5-3, 5-4
 Advanced function settings 3-7, 5-2, 5-3, 5-5
 Analog input 2-11, 2-13, 2-14, 2-15
 Automatic display return 5-88
 Average processing 1-2, 5-38
 Average type 5-39
 Averaging inputs 5-38
 Averaging times 5-39

B

Bank copy 1-4, 5-98
 Bank selection 1-4, 5-93
 Basic application methods 3-1
 Bottom hold 5-19, 5-33

C

Calculation 3-15, 3-19, 3-21, 3-24, 5-9
 Calculation mode 3-17, 3-22
 Cold junction compensation 1-4, 5-31
 Comparative output pattern 1-3, 5-44
 Comparative output status indicators 1-5, 5-59, 5-61, 5-63, 5-64
 Comparative outputs 2-7, 2-8, 5-59, 5-61, 5-63, 5-64
 Comparative outputs, holding 5-55
 Comparative set value 5-2, 5-3, 5-4
 Comparative set value banks 5-93, 5-98
 Comparative set value display 1-4, 5-82
 Component names and functions 1-2, 4-2, 4-4, 4-6, 4-8
 Constant K 3-19

D

Decimal point display 1-4
 Decimal point display, disabling 5-90
 Decimal point position 3-4, 3-7, 3-10, 3-15, 3-19, 3-21, 3-24, 5-17
 Detecting sudden input changes 5-41
 Display adjustment 5-2, 5-3, 5-4
 Display color 5-83

Display color selection 1-4, 5-83
 Display refresh period 1-4, 5-73
 Display value selection 1-4, 5-78
 Display, returning to RUN level 5-88
 Display, rightmost digit step 5-80
 Drawout 2-3
 Drift, eliminating 5-36

E

Event input 2-10
 External dimensions 2-2

F

Forced-zero 1-2, 3-14, 3-17, 3-22, 5-65
 Forced-zero compensation 5-70
 Forced-zero protect 5-103

H

HOLD input 5-19, 5-54
 Hysteresis 1-3

I

Initial setup 5-2, 5-3, 5-4
 Example for K3HB-H 4-6
 Example for K3HB-S 4-8
 Example for K3HB-V 4-4
 Example for K3HB-Z 4-2
 Initializing settings 5-100
 Input adjustment 5-2, 5-3, 5-4
 Input adjustment level 3-13
 Input calculation 1-2
 Input error enabled 5-29
 Input errors, operation for 5-29
 Input type 3-4, 3-7, 3-10, 3-12, 3-15, 3-19, 3-21, 3-24, 5-10, 5-11
 Inspecting for steps 3-22
 Initial setting level 3-24
 Input adjustment level 3-24
 RUN level 3-23
 Inspecting panel thickness 3-17

Initial setting level 3-19
 Input adjustment level 3-19
 RUN level 3-18

K

Key operations, restricting 5-102
 Key protection 1-3, 5-102

L

LCD field of vision 2-3
 LEVEL key 1-5
 Level output 5-44
 Level/bank display 1-5
 Linear output 1-3, 5-63

M

Max/Min hold 1-4
 MAX/MIN key 1-5
 Maximum and minimum values, holding 5-75
 Measurement operations 5-19
 Measurement status, holding 5-54
 Measurement value, setting to 0 5-65
 Measurement value, setting to 0 again 5-67
 Measurements, delaying 5-27
 Measurements, resetting 5-26
 Measuring disk eccentricity 3-20
 Initial setting level 3-21
 Input adjustment level 3-21
 Measuring/judging product height 3-14
 Display adjustment level 3-16
 Initial setting level 3-15
 Input adjustment level 3-15
 RUN level 3-15
 MODE key 1-5
 Monitoring motor load current 3-6
 Display adjustment level 3-8
 Initial setting level 3-7
 Input adjustment level 3-8
 RUN level 3-7
 Monitoring tank levels 3-2
 Display adjustment level 3-5
 Initial setting level 3-4
 Input adjustment level 3-4
 RUN level 3-4
 Monitoring/controlling temperature 3-11
 Advanced function setting level 3-12

Display adjustment level 3-13
 Initial setting level 3-12
 RUN level 3-12

Mounting method 2-3
 Moving average 5-38

N

Normal 3-19, 5-19, 5-33

O

OFF timing delay 5-33
 ON timing delay 5-33
 Output chattering 5-46
 Output logic 1-3, 5-59
 Output OFF delay 1-3, 5-52
 Output refresh stop 1-3
 Output test 1-3, 5-2, 5-3, 5-4, 5-92
 Outputs with set intervals 5-49
 Outputs, delaying turning OFF 5-52

P

Panel cutout dimensions 2-2
 Parameter display conditions A-12
 Parameter list A-12
 PASS output allocation 5-57
 PASS output change 1-3, 5-57
 PASS range and outputs 5-61
 Peak hold 5-19, 5-20, 5-33
 Position meter 1-4, 1-5, 3-14, 5-85
 Power supply 2-6
 Previous average value comparison 1-2
 Protect 5-2, 5-3, 5-4
 PV display 1-5

R

RESET input 5-19, 5-26
 Resetting measurements 5-26
 RUN 5-2
 RUN/adjustment protect 5-102

S

Sampling hold 3-15, 3-24, 5-19, 5-20, 5-33
Scaling 1-4, 3-4, 3-7, 3-10, 3-15, 3-19, 3-21, 3-24, 5-14
Scaling values 5-14
Sensor power supply 2-6
Set values 5-6
Setting change protect 5-102
Setting initialization 5-100
Setting level protect 5-102
SHIFT key 1-5
Shifting temperature input 5-24
Shot output 1-3, 5-52
Simple average 5-38
Standard output 5-44
Standby sequence 1-3
Startup compensation timer 1-3, 5-27
Status indicators 1-5
Step value 1-2, 5-80
SV display 1-5
SV display status indicators 1-5

T

Tare zero 1-2, 5-67
Teaching 1-3, 5-17
Temperature input, shifting 1-2, 5-24
Temperature unit 5-18
Timing delay 1-2
Timing hold 1-2, 3-4, 3-8, 3-10, 3-13, 3-15, 3-19, 3-21, 3-24, 5-19
TIMING input 5-19
Timing input 3-20
Timing inputs 5-33

U

UP key 1-5
User calibration 1-4
Using terminals 2-3

W

Weighing material 3-9
 Display adjustment level 3-10
 Initial setting level 3-10
 Input adjustment level 3-10
Wiring 2-6

Z

Zero-limit 1-2, 5-36
Zero-trimming 1-2, 5-70
Zone output 5-44



OMRON Corporation
Industrial Automation Company

Control Devices Division H.Q.
Analog Controller Division
Shiokoji Horikawa, Shimogyo-ku,
Kyoto, 600-8530 Japan
Tel: (81)75-344-7080/Fax: (81)75-344-7189

Regional Headquarters

OMRON EUROPE B.V.
Wegalaan 67-69, NL-2132 JD Hoofddorp
The Netherlands
Tel: (31)2356-81-300/Fax: (31)2356-81-388

OMRON ELECTRONICS LLC
1 East Commerce Drive, Schaumburg, IL 60173
U.S.A.
Tel: (1)847-843-7900/Fax: (1)847-843-8568

OMRON ASIA PACIFIC PTE. LTD.
83 Clemenceau Avenue,
#11-01, UE Square,
239920 Singapore
Tel: (65)6835-3011/Fax: (65)6835-2711

OMRON (CHINA) CO., LTD.
Room 2211, Bank of China Tower,
200 Yin Cheng Road (M),
Shanghai, 200120 China
Tel: (86)21-5037-2222/Fax: (86)21-5037-2200

Authorized Distributor: