



2 channels electronic time switch weekly cycle

ref.: 23142
ref.: 23152

Major characteristics

- Product delivered with current time and date set.
- Automatic change of winter/summer time \ast/\ast .
- Programming key \leftarrow .
 - for permanent override,
 - for program copy or save.
- Programming for day or group of days.
- 56 program steps On, Off.
- Permanent overrides On or Off (C1 permanent light on)
- Temporary overrides On or Off (C2 flashing).
- Display bar graph of daily profile.
- Keyboard locking possible lock .
- Programmable with power off.

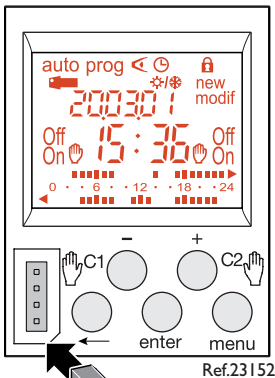

Ref.23152

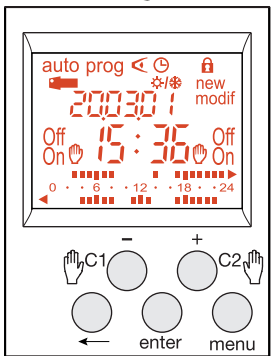

Ref.23142



Ref. 23142



Ref. 23152

Key

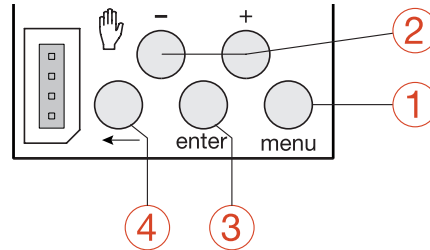

- ① **menu** : selection of operating mode
auto : mode of running according to the program selected.
prog: new for programming mode.
prog: modif to modify an existing program.
 \leftarrow : checking of the program.
 clock : modification of time, date and selection of the winter/summer time change mode \ast/\ast .
- ② **+ and -** : navigation or setting of values.
 C1 C1 : in **auto** mode, selection of C2 overrides.

- ③ **enter**: to validate flashing information on display.
 ④ \leftarrow : to return to the previous step.

You may return into **auto** mode at any moment using **menu**.

If no action is taken for 1 min, the switch returns into **auto** mode.

Reset

- **Program reset:**
the program may be completely cleared by simultaneously pressing the 3 following keys:
menu, enter, \leftarrow . The time and the date will be kept.
- **Total:**
pressing simultaneously the **-, +, enter, menu**, keys lets you clear the entire contents of the product.
Following a total reset it is necessary to reset the time and day of the device.

Technical specifications

Electrical characteristics

- Supply voltage: 230 V AC \pm 15%
- Frequency: 50/60 Hz
- Power consumption: max. 0,5 VA à 50 Hz
- Output: 2 changeover volt free contacts
- Maximum load:
 - ACI μ 16A 250V~
 - $\text{Cos } \varphi = 0,6$ μ 10A 250V~
- Incandescent lighting: 2300 W
- Halogen lighting 230 V: 2300 W
- Compensated fluorescent tubes // (max. 45 μ F): 400 W
- Non compensated fluorescent tubes, compacted in series: 1000 W
- Compact fluorescent lamps: 500 W
- Minimum current. ACI: 100 mA 250V~

- Galvanic insulation between power supply and output = 4 kV
- Degree of pollution: standard

Functional characteristics

- Programming capacity: 56 steps
- Minimum time between 2 steps: 1 minute
- Running accuracy: \pm 1,5 sec/24h
- Operating reserve: lithium battery provides 5 years of backup.
- The product is set into standby state (display switched-off) after 1 minute with power off.
It switches back into **auto** mode as soon as power is back or when pressing any key.
- Protection degree: IP 20

Environment

- Operating temperature: -5 °C to +45 °C
- Storage temperature: -20 °C to +70 °C

Connection

- Flexible capacity: 1 to 6 mm²
- Rigid capacity: 1,5 to 10 mm²

Connection diagram:

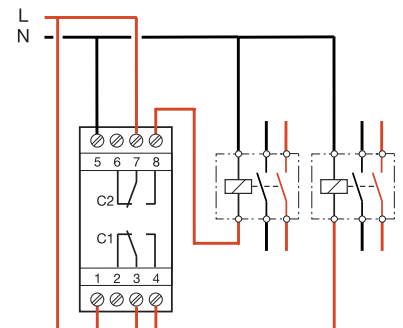

Programming: prog new

Programming may be done for each day or for a group of days. In this case instructions are common to several days.

Days: 1 = Monday, 2 = Tuesday, 3 = Wednesday... 7 = Sunday.

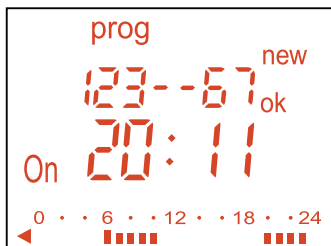

1. Select the **prog** mode using **menu**, then **enter**. New mode selected validate with **enter**.
2. Select the channel (A or B) using **+** or **-**, then **enter**.
The number of remaining program steps appears for a short time.
3. Select the day(s) using **+** or **-**. Validate with **enter**.
4. **ok** flashes. Use **enter** to validate the group.
5. Using **+** or **-**, select the state of the instruction: On, Off. Use **enter** to validate state.
6. Enter the hour of switch-on using **+** or **-**.
Validate with **enter**.
7. Enter minutes with **+** or **-**. Validate with **enter**.

Program the other instructions of the group of days by repeating operations 3 to 7.

The day or the group of days may be modified at the during step 3 by pressing the **+**, **-** or **←**.

At the end of programming return to **auto** mode using the **menu** button. To set the program of the other channel, return to prog new mode and proceed according to steps 2 to 7.

In this mode it is also possible to add an instruction to the program set up. Proceed as described above.

Display

To check the daily profile set up without the risk of modification or deletion: select the mode **◀** using **menu** and press **enter**.

Select the channel (C1 or C2) using **+** or **-** and **enter**.

The first step of Monday is displayed as well as the daily profile.

Two options available for display:

1. Pressing repeatedly **+** or **-**: lets you shift days. In this case only the first daily step is displayed as well as the daily profile.
2. Pressing **enter**: all steps of each day appear one after the other.

Modification or clearing of a program step: prog modif

Select the **prog** mode with **menu** and press **enter**.

Select the channel (C1 or C2) using **+** or **-** and **enter**.

Select the **modif** mode with **+** or **-**. Validate with **enter**.

The number of remaining program steps appears for a short time. The first step of the first day or group of days appears.

Repeatedly pressing the **enter** key displays all programmed steps one at a time.

Any flashing field (state, hour, minutes) may be modified using **+** or **-**, then validated with **enter**.

When the cursor is positioned on **ok** located behind the group of days, you may display successively the days or the groups of days and switch directly to the one that has to be modified using **+** or **-**.

To remove a program step: select the state of the channel (On or Off), press simultaneously **+** and **-**.

Clear appears on the screen. Validate with **enter**. At the end of programming, return to auto mode using the **menu** button.

Key (only ref. 23152)

As soon as the key is inserted into the switch,  appears on the screen.

Two types of operation:

A. Permanent override:

Insert the key into the switch.

After 10 seconds the program contained in the key will be executed without clearing the program contained in the time switch.

As soon as the key is removed the program of the time switch is again valid.

B. Copy (load)/Save (save):

The key makes it possible to save a program contained in the time switch.

It is also possible to copy the contents of the key into the clock.

1. Insert the key and wait for 2 sec.

2. Using **menu** select the mode:

save to save a program contained in the time switch,

load to load the program of the key into the time switch,  to check the program contained in the key.

3. Validate the selection with **enter**.

4. For **save** and **load** reconfirm with **enter**.

The following error messages may appear on the screen:

no prog: the key is empty, it does not contain any program.

Error: the key is that of a one-channel switch.

In these two cases:

- Only the **save** (to key) is possible.
- The error message remains on display as long as the key is present, but in this case the program of the time switch is executed.

Setting time and day

Winter/summer time change

Select the mode  with **menu** then **enter**.

Modify the day, month, year, the hour and the minutes using **+** or **-** and **enter**. The time switch next suggests the winter/summer time changes .

Select the type of change desired using **+** or **-**.

Validate with **enter**.

The type of change depends on the geographical zone.

Types available:

Type	Start of time change Summer	Start of time change Winter	Zone of application
Euro *	Last Sunday of March	Last Sunday of October	European Union
USA	First Sunday of April	Last Sunday of October	North America
GB	Last Sunday of March	Fourth Sunday of October	Only for the United Kingdom
USER	Date freely programmed	Date freely programmed	
No	No change	No change	

* type according defect

The change always takes place between 2:00 and 3:00 a.m.

When the USER type is selected:



1. Enter the day then the month of the date of change of the summer time (+ 1 hour) with **+** or **-** and **enter**.
2. Enter the day then the month of the date of change of the winter time (- 1 hour) with **+** or **-** and **enter**.

The time switch will check which days of which weeks correspond to these dates and will apply changes to the same periods for the following years independently of the date.

Override

Pressing repeatedly C1  or C2 .

If the state of the output is **On**:

- 1st press: temporary override. **Off** and  flash. The next program step will let you return to the automatic mode.
- 2nd press: permanent override. **On** and  are permanent. This override must be cancelled manually.
- 3rd press: permanent override. **Off** and  are permanent. This override must be cancelled manually.
- 4th press: return to the automatic mode.

Locking

To prevent all undesirable actions, the keyboard of the time switch may be locked using a key ref. 23193 or pressing the **enter** and **←** keys for 7 seconds.

Unlocking is done in the same way.