

DIN Rail Mount 35 mm HSV Part number 84874320



- Control of overspeed, underspeed, operating rate, stopping
- Measurement via discrete sensors - 3-wire PNP or NPN, Namur, voltage 0-30V or volt-free contact type
- Works with either NO or NC sensors
- Time between pulses adjustable from 0.05 s to 10 min.
- Power-on inhibit time, adjustable from 0.6 to 60 s
- Inhibit time can be managed via an external contact

Part numbers

Type	Nominal voltage (V)
84874320 HSV	24 →240 V AC/DC

Specifications

Supply

Supply voltage Un	24 V →240 V AC/DC
Voltage supply tolerance	-15 % / +10 %
Operating range	20,4 V →264 V AC/DC
Polarity with DC voltage	No
AC supply voltage frequency	50 / 60 Hz ±10 %
Galvanic isolation of power supply/measurement	No
Power consumption at Un	5 VA in AC/3 W in DC
Immunity from micro power cuts	50 ms

Inputs and measuring circuit

Input circuit 3-wire sensors	PNP or NPN, 12V, 50 mA max.
Input circuit NAMUR sensor	12 V / 1.5 K Ω *
Input circuit Contact	12 V / 9.5 K Ω
Input circuit Voltage input	0 V min. /30 V max. /9.5 K Ω High state 4.5 V min. Low state 1 V max.
Minimum pulse time	5 ms in high and low state
Frequency of measured signal	1.5 m Hz minimum, 22 Hz maximum
Measurement ranges	0,5 s - 1 s - 5 s - 10 s - 1 mn - 5 mn - 10 mn
Threshold adjustment	10 →100 % of the range
Fixed hysteresis	5 % of displayed threshold
Display precision	±10 % of full scale
Repetition accuracy with constant parameters	± 0,5 %
Measuring error with voltage drift	< 1 % across the whole range
Measuring error with temperature drift	± 0,1 % / °C max.

Timing

Maximum threshold crossing response time	15 ms
Reset time S2	50 ms minimum (in memory mode)
Reset time	In memory mode (power break) : 1500 ms minimum
Inhibit time delay	On energisation : 0,6 →60 s (0, +10 % of full scale)
Repetition accuracy with constant parameters	± 0,5 %
Delay on pick-up	50 ms
Display precision	±10 % of full scale

Output

Type of output	1 single pole changeover relay
Type of contacts	No cadmium
Maximum breaking voltage	250 V AC/ DC
Max. breaking current	5A AC/DC
Min. breaking current	10 mA / 5 V DC
Electrical life (number of operations)	1 x 10 ⁵
Breaking capacity (resistive)	1250 VA AC
Maximum rate	360 operations/hour at full load
Operating categories acc. to IEC/EN 60947-5-1	AC 12, AC 13, AC 14, AC 15, DC 12, DC 13, DC 14
Mechanical life (operations)	30 x 10 ⁶

Insulation

Nominal insulation voltage IEC/EN 60664-1	250 V
Insulation coordination (IEC/EN 60664-1)	Overvoltage category III : degree of pollution 3
Rated impulse withstand voltage (IEC/EN 60664-1)	4 KV (1,2 / 50 μ s)

Dielectric strength (IEC/EN 60664-1)	2 kV AC 50 Hz 1 min
Insulation resistance (IEC/EN 60664-1)	> 500 MΩ / 500 V DC
General characteristics	
Display power supply	Green LED
Display relay	Yellow LED
Inhibit display	Yellow LED
Casing	35 mm
Mounting	On 35 mm symmetrical DIN rail, IEC/EN 60715
Mounting position	All positions
Material : enclosure plastic type VO to UL94 standard	Incandescent wire test according to IEC 60695-2-11 & NF EN 60695-2-11
Protection (IEC/EN 60529)	Terminal block : IP20 Casing : IP30
Weight	120 g
Connecting capacity IEC/EN 60947-1	Rigid : 1 x 4 ² - 2 x 2.5 ² mm ² 1 x 11 AWG - 2 x 14 AWG Flexible with ferrules : 1 x 2.5 ² - 2 x 1.5 ² mm ² 1 x 14 AWG - 2 x 16 AWG
Max. tightening torques IEC/EN 60947-1	0,6 →1 Nm / 5,3 →8,8 Lbf.In
Operating temperature IEC/EN 60068-2	-20 →+50 °C
Storage temperature IEC/EN 60068-2	-40 →+70 °C
Humidity IEC/EN 60068-2-30	2 x 24 hr cycle 95 % RH max. without condensation 55 °C
Vibrations according to IEC/EN60068-2-6	10 →150 Hz, A = 0.035 mm
Shocks IEC/EN 60068-2-6	5 g
Standards	
Marking	CE (DBT) 2006/95/EC - EMC 2004/108/EC
Product standard	NF EN 60255-6 / IECI 60255-6 / UL 508 / CSA C22.2 N°14
Electromagnetic compatibility	Immunity EN 61000-6-2/IEC 61000-6-2 Emission EN 61000-6-4/EN 61000-6-3 IEC 61000-6-4/IEC 61000-6-3 Emission EN 55022 class B
Certifications	UL, CSA
Conformity with environmental directives	RoHS

Comments**Accessories**

Description	Code
Removable sealable cover for 35 mm casing	84800001

Principles**Overview**

The HSV relay controls the speed (or, more strictly speaking, the operating rate, or frequency) of a process (moving walkway, conveyor, etc.) using discrete sensors :

- 3-wire PNP or NPN output proximity sensor
- voltage input 0 - 30 V
- NAMUR proximity sensor
- volt-free contact

It can be used to monitor under OR overspeed

Operating principle**Measurement**

The monitored process cycle is the succession of pulses characterised by a signal with two states : high and low. The speed measurement is obtained by measuring the duration of this signal, from the first detected change of state (either a rising or falling edge).

Digital signal processing avoids the problem of disparity of signals.

From energisation, or after the appearance (or reappearance) of the sensor signal, detection (characterisation) of the signal requires processing of one or more periods (two maximum).

During this time, control is inoperative.

Operating mode

Using the selector switch, select one of four modes :

- Underspeed without latching
- Underspeed with latching
- Overspeed without latching
- Overspeed with latching

If, on energisation, the switch is placed in one of the three intermediate positions (between "underspeed with latching" and "overspeed with latching"), the relay stays in the rest state ("alarm") and the error is signalled by all three LEDs flashing simultaneously.

The mode selector switch position is taken into account on energisation.

Modifications made during operation will have no effect : the active configuration may therefore be different from that indicated by the switch, the relay operates normally but the change in configuration is signalled by all three LEDs flashing simultaneously.

Latching

In "memory" mode, when a fault has been recorded, the HSV relay latches in the rest position ("alarm" operational state). Once the speed is correct again, the relay can be unlatched (reset) by closing contact S2 (for 50 ms minimum).

Irrespective of the speed of the controlled process, when S2 is closed the HSV relay is inhibited, the output is at the operating point ("normal" operational state) ; if the speed is still not correct when contact S2 is reopened, the relay latches again in the rest position ("alarm" operational state).

The HSV can also be reset, by switching off and on again several times in succession (the power break must last at least 1500 ms).

If the process speed is incorrect, this method is limited by the same restriction as resetting using S2.

Principles

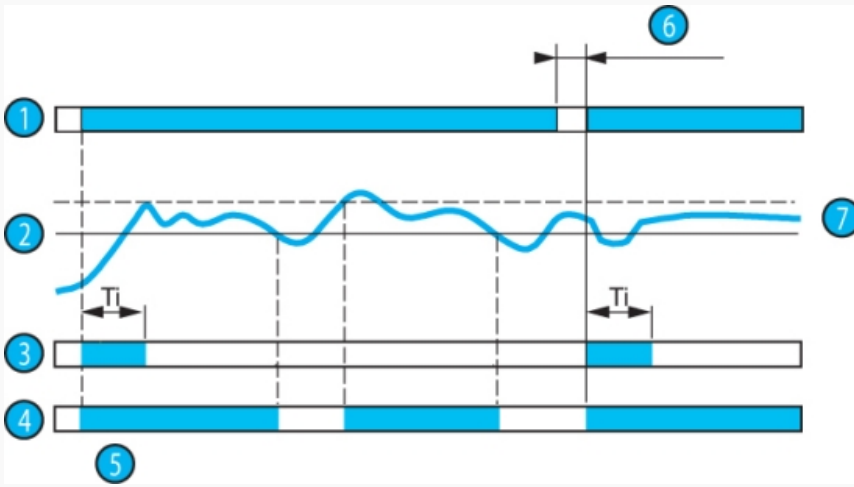

After the end of the inhibit delay on starting, "Ti", as soon as the measured speed drops below the threshold value, the output relay changes state, from operating point to rest position ("alarm" operational state, 11-14 open and 11-12 closed).

It returns to the initial state when the speed rises above the threshold plus the hysteresis (fixed at 5 % of the displayed threshold).

After the power supply returns, following a break that has lasted at least 1500 ms, the relay is in the ("normal") operating state during the time delay and stays there until the speed is above the threshold.

N°	Legend
1	Voltage (S1)
2	Threshold
3	Inhibit LED
4	Relay
5	Inhibit delay on starting (Ti)
6	1500 ms min.
7	Speed

Principles

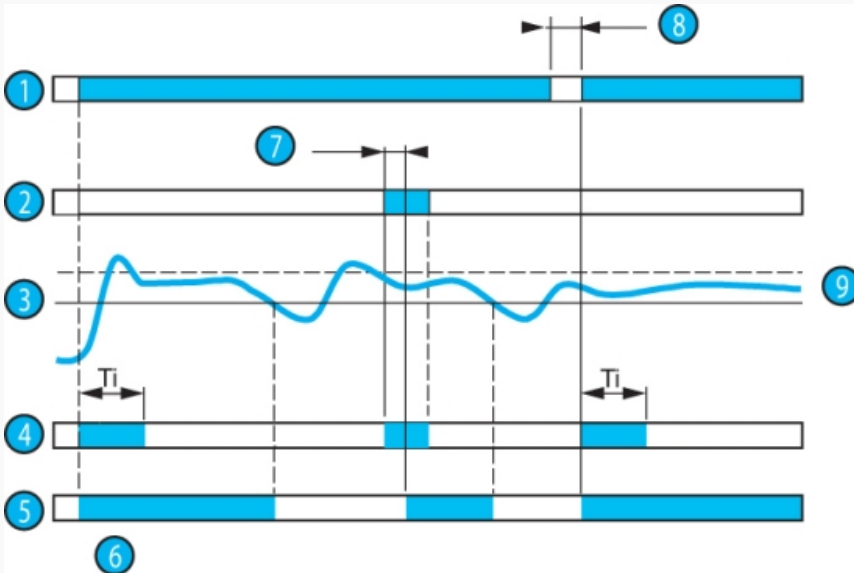

When the HSV has been configured in "memory" mode, if underspeed is detected, the output relay stays in the rest state ("alarm") irrespective of any subsequent change in the speed of the process.

It will not be able to revert to ("normal") operating state until contact S2 closes (50 ms minimum).

If, when S2 reopens, the speed is inadequate, the relay reverts to the rest latched state ("alarm").

The HSV can also be reset by a power break (1500 ms minimum) ; the relay then returns to the ("normal") operating state for at least the duration of the time delay, irrespective of the speed of the process.

N°	Legend
----	--------

1	Voltage (S1)
2	Contact S2
3	Threshold
4	Inhibit LED
5	Relay
6	Inhibit delay on starting (Ti)
7	50 ms min.
8	1500 ms min.
9	Speed

Principles

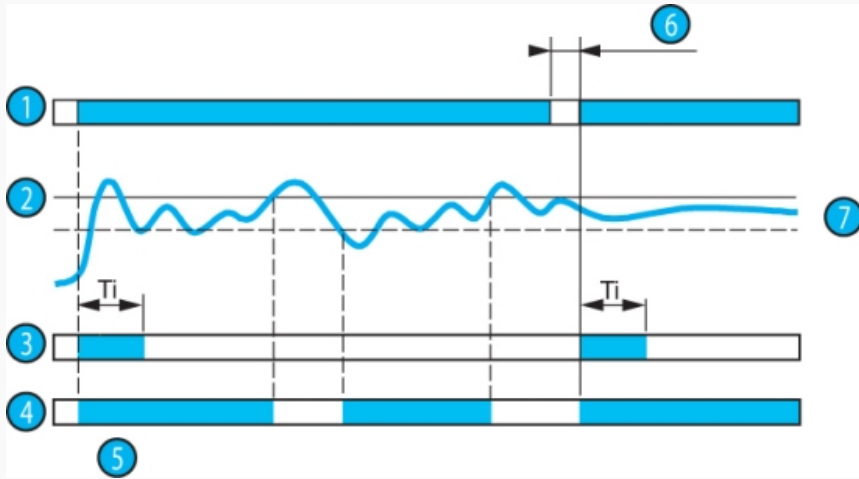

After the end of the inhibit delay on starting, "Ti", as soon as the measured speed rises above the threshold value, the output relay changes state, from operating point to rest position ("alarm" operational state, 11-14 open and 11-12 closed). It returns to the initial state when the speed falls back below the threshold minus the hysteresis (fixed at 5 % of the displayed threshold). After a power break that has lasted at least 1500 ms, the relay is in the ("normal") operating state during the time delay and stays there until the speed is below the threshold.

N°	Legend
1	Voltage (S1)
2	Threshold
3	Inhibit LED
4	Relay
5	Inhibit delay on starting (Ti)
6	1500 ms min.
7	Speed

Principles

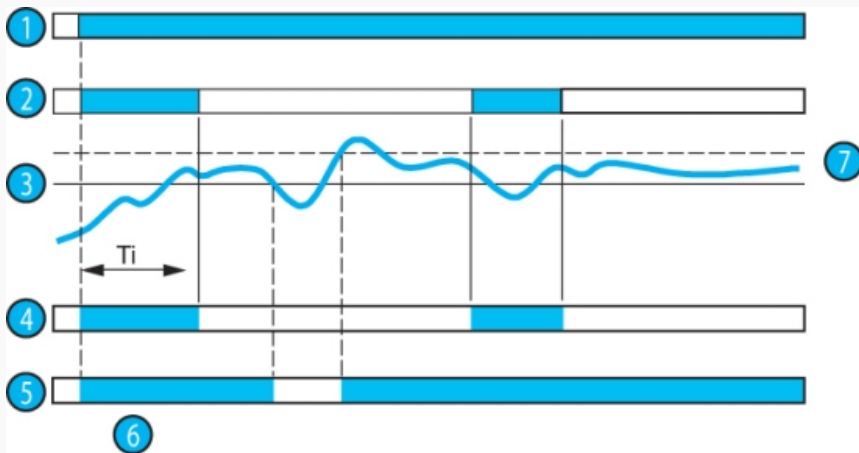

On energisation, to allow the controlled process to reach its nominal operating speed, the HSV relay is inhibited for a period that is adjustable from 0.6 to 60 seconds.

This time delay can be modified during inhibition to be shorter or longer.

The HSV relay can also be inhibited by the closing of contact S2 : on starting, for example, if the process acceleration time is more than 60 s, or at any time during operation.

Irrespective of the origin (delay on starting or S2 closing), inhibition maintains the output relay in the "closed" position ("normal" operational state, contacts 11-14 closed and 11-12 open) and is signalled by the Inhibit LED lighting up.

If, after removal of the inhibition (end of delay on starting or opening of contact S2), the signal detection phase has not ended, the relay drops out after the expected time between two pulses (measured from the end of inhibition).

Inhibition must last for as long as required for the product to detect at least 2 periods.

If the signal type has not been determined at the end of the inhibit period, the "inhibit" LED flashes for as long as it is impossible to measure the speed.

Similarly, during operation, it is possible to inhibit the HSV relay at any time by closing S2.

N°	Legend
1	Voltage (S1)
2	Contact S2
3	Threshold
4	Inhibit LED
5	Relay
6	Inhibit delay on starting (Ti)
7	Speed

Principles

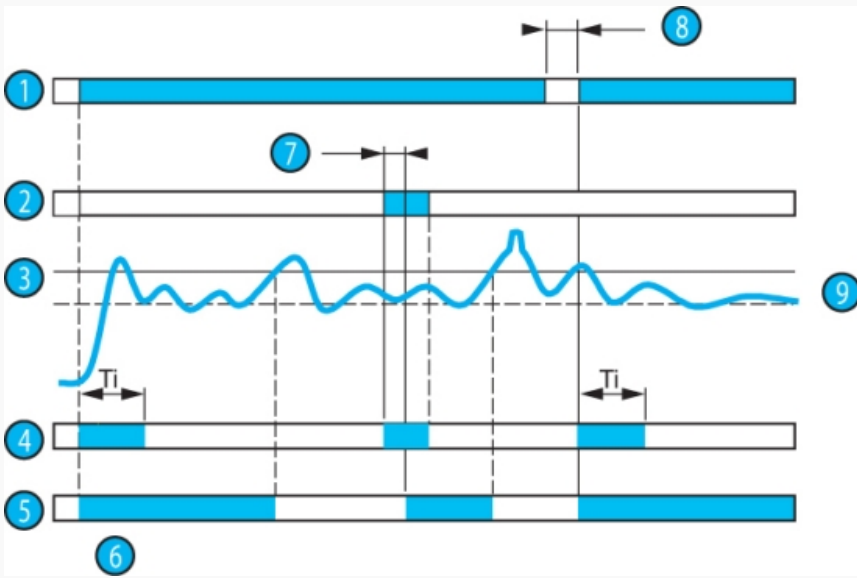

When the HSV has been configured in "memory" mode, if overspeed is detected, the output relay stays in the rest state ("alarm") irrespective of any subsequent change in the speed of the process. It will not be able to revert to ("normal") operating state until contact S2 closes (50 ms minimum). If, when S2 reopens, the speed is too high, the relay reverts to the rest latched state ("alarm").

The HSV can also be reset by a power break (1500 ms minimum) ; the relay then returns to the ("normal") operating state for at least the duration of the time delay, irrespective of the speed of the process.

N°	Legend
1	Voltage (S1)
2	Contact S2
3	Threshold
4	Inhibit LED
5	Relay
6	Inhibit delay on starting (Ti)
7	50 ms min.
8	1500 ms min.
9	Speed

Principles

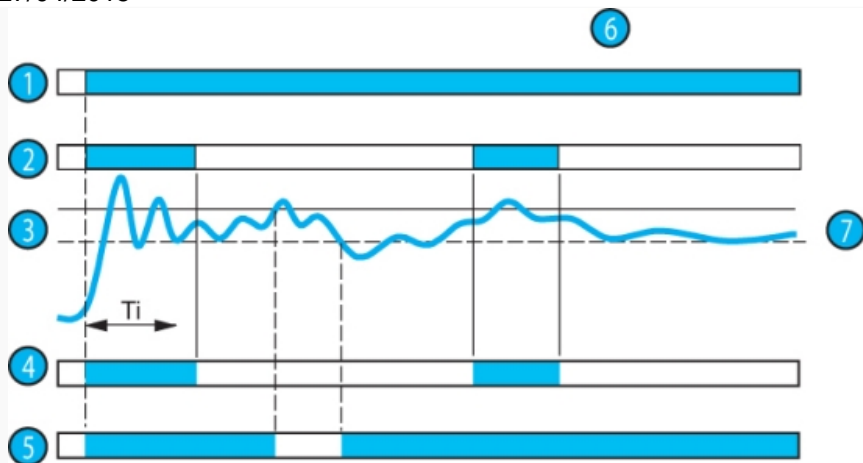

It is possible to inhibit the HSV relay by closing external contact S2 until the process has reached its nominal speed.

N°	Legend
1	Voltage (S1)
2	Contact S2
3	Threshold
4	Inhibit LED
5	Relay
6	Inhibit delay on starting (Ti)
7	Speed

Dimensions (mm)

HSV

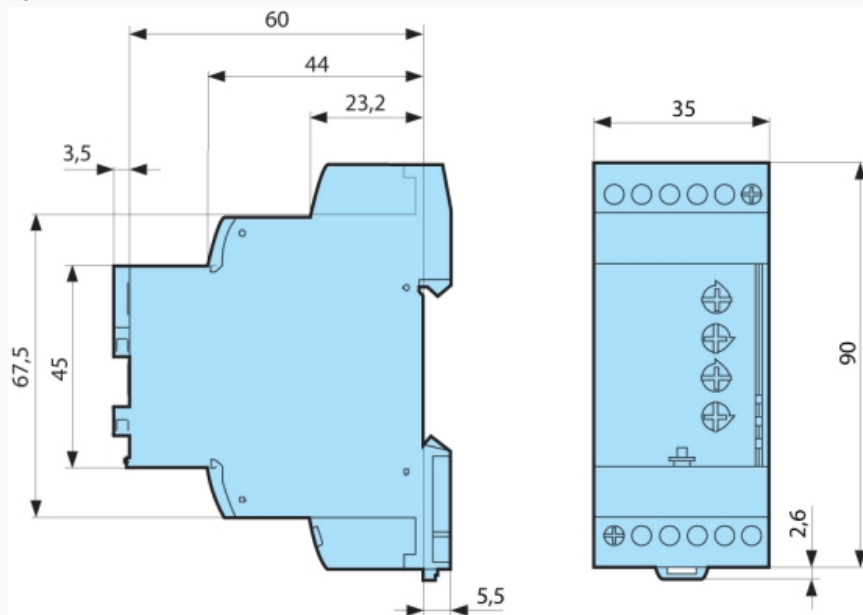

mm

Connections

HSV - Input circuits

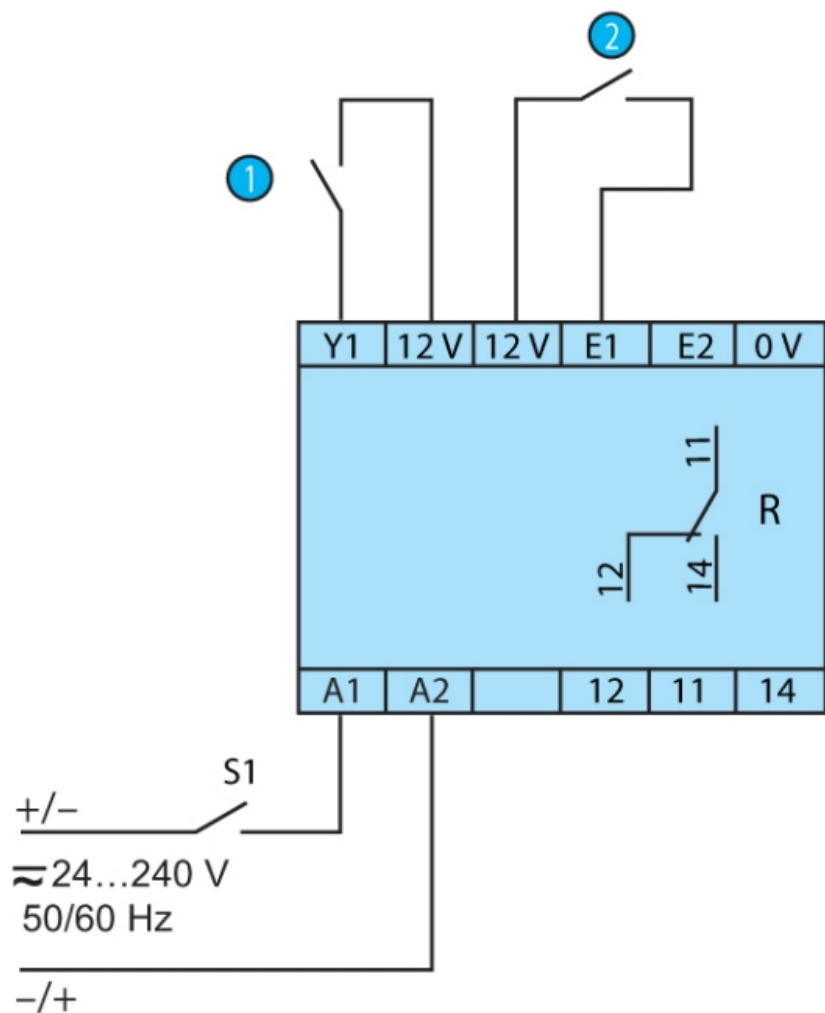

N°	Legend
①	S2 Inhibition - Reset
②	Entrée contact sec 12 V, 9,5 kΩ

Connections

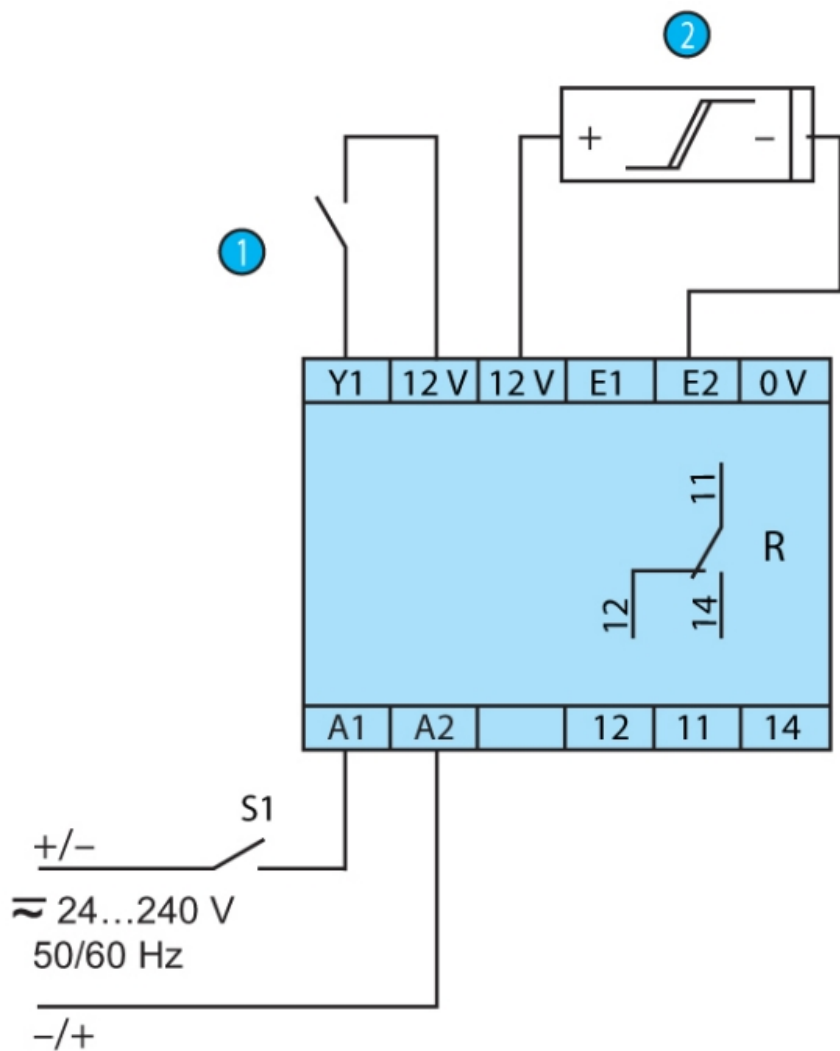

N°	Legend
1	S2 Inhibit - Reset
2	NAMUR proximity sensor input 12 V, 1.5 kΩ

Connections

2

1

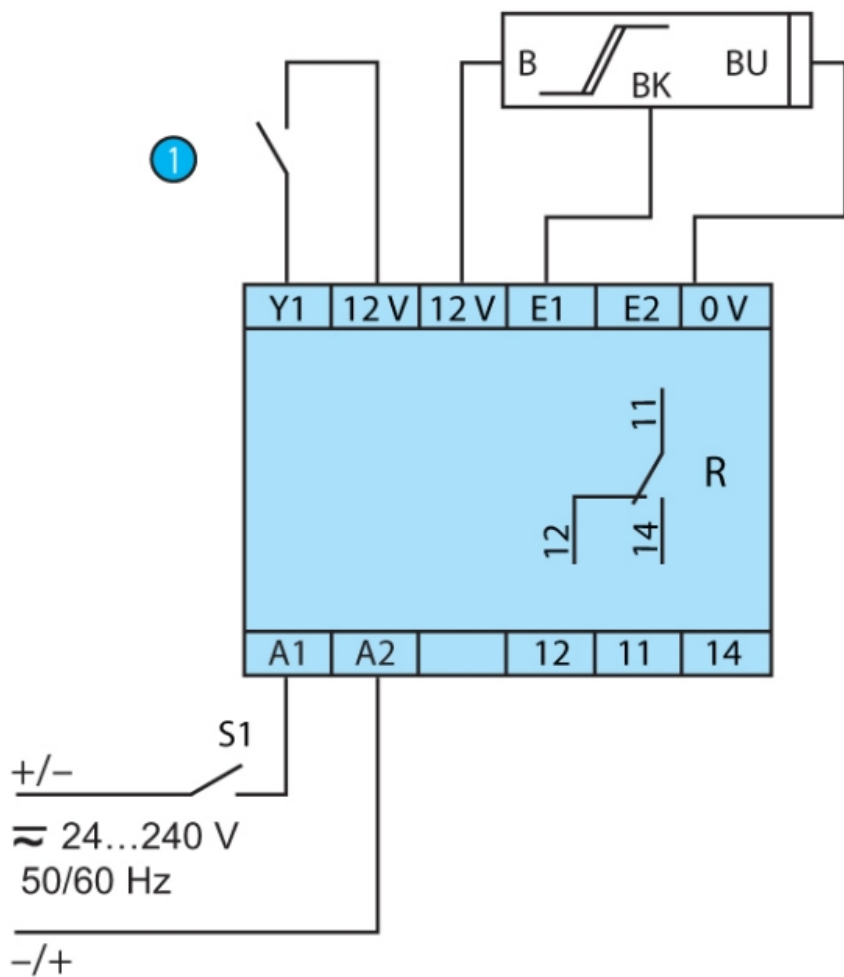

N°	Legend
1	S2 Inhibit - Reset
2	3-wire PNP/NPN proximity switch 12 V, 50 mA max.

Connections

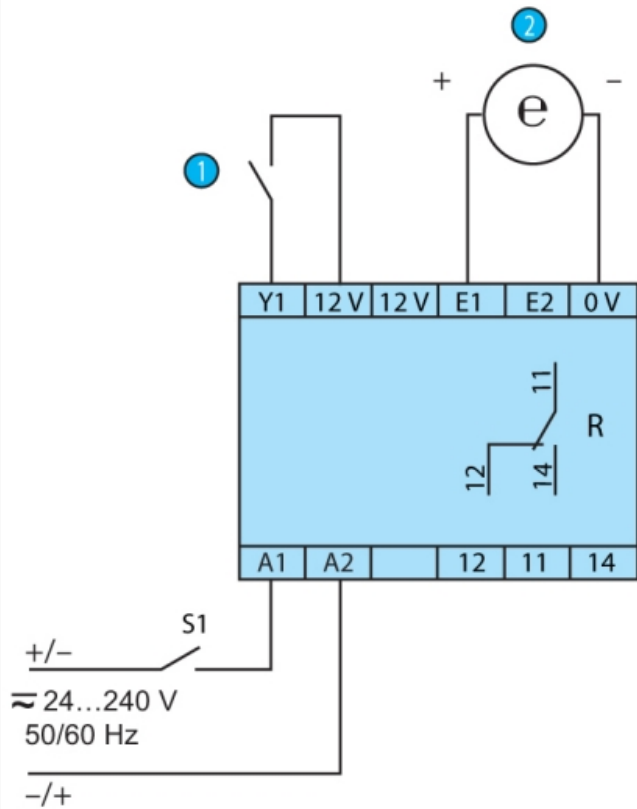

N°	Legend
1	S2 Inhibit - Reset
2	Voltage input 0 V - 30 V

Product adaptations



- Customisable colours and labels
- Possible to delete settings
- Fixed threshold in the generic measurement range
- Fixed or adjustable time delay